

# **Vigor2865 Series 35b Security Firewall Quick Start Guide (for RF Model)**

**Version: 2.0**

**Firmware Version: V4.4.5**

**(For future update, please visit DrayTek web site)**

**Date: July 17, 2024**

## Intellectual Property Rights (IPR) Information

### Copyrights

© All rights reserved. This publication contains information that is protected by copyright. No part may be reproduced, transmitted, transcribed, stored in a retrieval system, or translated into any language without written permission from the copyright holders.

### Trademarks

The following trademarks are used in this document:

- Microsoft is a registered trademark of Microsoft Corp.
- Windows 8, 10, 11 and Explorer are trademarks of Microsoft Corp.
- Apple and Mac OS are registered trademarks of Apple Inc.
- Other products may be trademarks or registered trademarks of their respective manufacturers.

## Safety Instructions and Approval

### Safety Instructions

- Read the installation guide thoroughly before you set up the router.
- The router is a complicated electronic unit that may be repaired only by authorized and qualified personnel. Do not try to open or repair the router yourself.
- Do not place the router in a damp or humid place, e.g. a bathroom.
- Do not stack the routers.
- The router should be used in a sheltered area, within a temperature range of +5 to +40 Celsius.
- Do not expose the router to direct sunlight or other heat sources. The housing and electronic components may be damaged by direct sunlight or heat sources.
- Do not deploy the cable for LAN connection outdoor to prevent electronic shock hazards.
- Do not power off the router when saving configurations or firmware upgrades. It may damage the data in a flash. Please disconnect the Internet connection on the router before powering it off when a TR069/ACS server manages the router.
- Keep the package out of reach of children.
- When you want to dispose of the router, please follow local regulations on conservation of the environment.

### Warranty

We warrant to the original end user (purchaser) that the router will be free from any defects in workmanship or materials for a period of two (2) years from the date of purchase from the dealer. Please keep your purchase receipt in a safe place as it serves as proof of date of purchase. During the warranty period, and upon proof of purchase, should the product have indications of failure due to faulty workmanship and/or materials, we will, at our discretion, repair or replace the defective products or components, without charge for either parts or labor, to whatever extent we deem necessary to restore the product to proper operating condition. Any replacement will consist of a new or re-manufactured functionally equivalent product of equal value, and will be offered solely at our discretion. This warranty will not apply if the product is modified, misused, tampered with, damaged by an act of God, or subjected to abnormal working conditions. The warranty does not cover the bundled or licensed software of other vendors. Defects which do not significantly affect the usability of the product will not be covered by the warranty. We reserve the right to revise the manual and online documentation and to make changes from time to time in the contents hereof without obligation to notify any person of such revision or changes.



## Declaration of Conformity

Hereby, DrayTek Corporation declares that the equipment type Vigor2865 is in compliance with Radio Equipment Directive 2014/53/EU, Low Voltage Directive 2014/35/EU and RoHS 2011/65/EU.

The full text of the EU Declaration of Conformity is available at the following internet address:  
<https://fw.draytek.com.tw/Vigor2865/Document/CE/>

Manufacturer: DrayTek Corp.

Address: No. 26, Fushing Rd., Hukou, Hsinchu Industrial Park, Hsinchu 303, Taiwan

Product: Vigor2865 Wireless Series

Frequency Information for Europe area:

2.4GHz WLAN	For ac series, 2400MHz - 2483MHz, max. TX power: 19.78dBm *1
	For ax series, 2400MHz - 2483MHz, max. TX power: 19.86dBm *1
5GHz WLAN	For ac series, 5150MHz - 5350MHz, max. TX power: 22.84dBm *2 5470MHz - 5725MHz, max. TX power: 27.88dBm *2
	For ax series, 5150MHz - 5350MHz, max. TX power: 22.79dBm *2 5470MHz - 5725MHz, max. TX power: 29.78dBm *2
5G-NR	n1[1920-1980 MHz (TX); 2110-2170 MHz (RX)]; n3[1710-1785 MHz (TX); 1805-1880 MHz (RX)]; n7[2500-2570 MHz (TX); 2620-2690 MHz (RX)]; n8[880-915 MHz (TX); 925-960 MHz (RX)]; n20[832-862 MHz (TX); 791-821 MHz (RX)]; n28[703-748 MHz (TX); 758-803 MHz (RX)]; n38[2570-2620 MHz (TX/RX)]; n40[2300-2400 MHz (TX/RX)] ; n77[3300-4200 MHz (TX/RX)] ; n78[3300-3800 MHz (TX/RX)] *4
LTE	B1[1920-1980 MHz (TX); 2110-2170 MHz (RX)]; B3[1710-1785 MHz (TX); 1805-1880 MHz (RX)]; B7[2500-2570 MHz (TX); 2620-2690 MHz (RX)]; B8[880-915 MHz (TX); 925-960 MHz (RX)]; B20[832-862 MHz (TX); 791-821 MHz (RX)]; B28[703-748 MHz (TX); 758-803 MHz (RX)]; B38[2570-2620 MHz (TX); 2570-2620 MHz (RX)]; B40[2300-2400 MHz (TX); 2300-2400 MHz (RX)]*3
3G	B1[1920-1980 MHz (TX); 2110-2170 MHz (RX)]; B8[880-915 MHz (TX); 925-960 MHz (RX)] *3
	Requirements in AT/BE/BG/CZ/DK/EE/FR/DE/IS/IE/IT/EL/ES/CY/LV/LI/LT/LU/HU/MT/NL/NO/PL/PT/RO/SI/SK/TR/FI/SE/CH/HR/UK(NI). 5150MHz-5350MHz is for indoor use only.

(\*1: for 2.4GHz WLAN model; \*2: for 5GHz WLAN model; \*3: for LTE model; \*4: for 5G-NR model)

This product is designed for 5G-NR, LTE, DSL and 2.4GHz /5GHz WLAN network throughout the EC region.



## Declaration of Conformity

Hereby, DrayTek Corporation declares that the equipment type Vigor2865 is in compliance with the Radio Equipment Regulations 2017 (SI 2017 No.1206, The Electrical Equipment (Safety) Regulations 2016 (SI 2016 No.1101), and The Restriction of the Use of Certain Hazardous Substances in Electrical and Electronic Equipment Regulations 2012 (SI 2012 No. 3032).

The full text of the UKCA Declaration of Conformity is available at the following internet address:  
<https://fw.draytek.com.tw/Vigor2865/Document/CE/>

Manufacturer: DrayTek Corp.

Address: No. 26, Fushing Rd., Hukou, Hsinchu Industrial Park, Hsinchu 303, Taiwan

Product: Vigor2865 Wireless Series

Importer: UK - CMS Distribution Limited, 15 Worship Street, London, EC2A 2DT  
Ireland - CMS Distribution Limited, Bohola Road, Kiltimagh, Co Mayo, Ireland

Frequency Information for UK area:

2.4GHz WLAN	For ac series, 2400MHz - 2483MHz, max. TX power: 19.78dBm *1
	For ax series, 2400MHz - 2483MHz, max. TX power: 19.86dBm *1
5GHz WLAN	For ac series, 5150MHz - 5350MHz, max. TX power: 22.84dBm *2
	5470MHz - 5725MHz, max. TX power: 27.88dBm *2
	For ax series, 5150MHz - 5350MHz, max. TX power: 22.79dBm *2
	5470MHz - 5725MHz, max. TX power: 29.78dBm *2
5G-NR	n1[1920-1980 MHz (TX); 2110-2170 MHz (RX)]; n3[1710-1785 MHz (TX); 1805-1880 MHz (RX)]; n7[2500-2570 MHz (TX); 2620-2690 MHz (RX)]; n8[880-915 MHz (TX); 925-960 MHz (RX)]; n20[832-862 MHz (TX); 791-821 MHz (RX)]; n28[703-748 MHz (TX); 758-803 MHz (RX)]; n38[2570-2620 MHz (TX/RX)]; n40[2300-2400 MHz (TX/RX)]; n77[3300-4200 MHz (TX/RX)]; n78[3300-3800 MHz (TX/RX)] *4
LTE	B1[1920-1980 MHz (TX); 2110-2170 MHz (RX)]; B3[1710-1785 MHz (TX); 1805-1880 MHz (RX)]; B7[2500-2570 MHz (TX); 2620-2690 MHz (RX)]; B8[880-915 MHz (TX); 925-960 MHz (RX)]; B20[832-862 MHz (TX); 791-821 MHz (RX)]; B28[703-748 MHz (TX); 758-803 MHz (RX)]; B38[2570-2620 MHz (TX); 2570-2620 MHz (RX)]; B40[2300-2400 MHz (TX); 2300-2400 MHz (RX)]*3
3G	B1[1920-1980 MHz (TX); 2110-2170 MHz (RX)]; B8[880-915 MHz (TX); 925-960 MHz (RX)] *3
	Requirements in UK. 5150MHz-5350MHz is for indoor use only.

(\*1: for 2.4GHz WLAN model; \*2: for 5GHz WLAN model; \*3: for LTE model;\*4: for 5G-NR model)  
This product is designed for 5G-NR, LTE, DSL and 2.4GHz /5GHz WLAN network use in the UK & Ireland.



**UK PSTI STATEMENT OF COMPLIANCE**

We, DrayTek Corp., office at No.26, Fushing Rd., Hukou, Hsinchu Industrial Park, Hsinchu 303, Taiwan, declare under our sole responsibility that the product

The full text of the PSTI Declaration of Conformity is available at the following internet address: <https://fw.draytek.com.tw/UK/PSTI/>

- Product name: 35b Security Router with WLAN/5G-NR/LTE/VoIP
- Model number: Vigor2865LVax-5G, Vigor2865Lax-5G, Vigor2865LV-5G, Vigor2865L-5G, Vigor2865LVac, Vigor2865LVax, Vigor2865LV, Vigor2865Vac, Vigor2865Vax, Vigor2865Lac, Vigor2865Lax, Vigor2865ac, Vigor2865ax, Vigor2865V, Vigor2865L, Vigor2865
- Manufacturer: DrayTek Corp.
- Address: No.26, Fushing Rd., Hukou, Hsinchu Industrial Park, Hsinchu 303, Taiwan

is in conformity with the relevant UK Statutory Instruments: The Product Security and Telecommunications Infrastructure (Security Requirements for Relevant Connectable Products) Regulations 2023 (“Security Requirements”).

Standard	Version
The Product Security and Telecommunications Infrastructure Regulations	2023 Schedule 1
Support Period	5 years after the EOL notification

Please note that this statement of compliance, including the Defined Support Period stated herein, is only applicable to products sold in the UK.

This Statement of Compliance is retained by DrayTek for 10 years after date of issue.

Hsinchu  
(place)

11th Apr., 2024  
(date)

  
Alan Wen  
General Manager Office. VP  
 (Legal Signature)

\*The external power supply used for each product will be model dependent.

	1	2	3	4	5	6	7	8	9	10	11	12
A Manufacturer	CWT	CWT	CWT	CWT	CWT	APD	APD	APD	APD	MOSO	MOSO	MOSO
B Address	No. 222, Sec. 2, Nankan Rd., Lujhu Township, Taoyuan County 338, Taiwan	No. 222, Sec. 2, Nankan Rd., Lujhu Township, Taoyuan County 338, Taiwan	No. 222, Sec. 2, Nankan Rd., Lujhu Township, Taoyuan County 338, Taiwan	No. 222, Sec. 2, Nankan Rd., Lujhu Township, Taoyuan County 338, Taiwan	No. 222, Sec. 2, Nankan Rd., Lujhu Township, Taoyuan County 338, Taiwan	No. 5, Lane 83, Lung-Sou St., Taoyuan City 330, Taiwan	No. 5, Lane 83, Lung-Sou St., Taoyuan City 330, Taiwan	No. 5, Lane 83, Lung-Sou St., Taoyuan City 330, Taiwan	No. 5, Lane 83, Lung-Sou St., Taoyuan City 330, Taiwan	Sangtai Industrial Park, Guanwai Xiaobaimang Songbai Road, Nanshan District, 518108 Shenzhen, Guangdong, China	Sangtai Industrial Park, Guanwai Xiaobaimang Songbai Road, Nanshan District, 518108 Shenzhen, Guangdong, China	Sangtai Industrial Park, Guanwai Xiaobaimang Songbai Road, Nanshan District, 518108 Shenzhen, Guangdong, China
C Model identifier	2ABB012F UK 2ABB012F EU	2ABB018F UK 2ABB018F EU	2ABL024F UK 2ABL024F EU	2ABL030F UK 2ABL030F EU	2ABN036F UK 2ABN036F EU	WA-12M12FG WA-12M12FK	WB-18D12FG WB-18D12FK	WA-24Q12FG WA-24Q12FK	WA-36A12FG WA-36A12FK	MS-V2000R120-024Q0-GB MS-V2000R120-024Q0-DE	MSS-V2500WR120-030E0-GB MSS-V2500WR120-030E0-DE	V30-V3000R120-0-036T0-GB V30-V3000R120-0-036T0-DE
D Input voltage	100-240V	100-240V	100-240V	100-240V	100-240V	100-240V	100-240V	100-240V	100-240V	100-240V	100-240V	100-240V
E Input AC frequency	50/60Hz	50/60Hz	50/60Hz	50/60Hz	50/60Hz	50/60Hz	50/60Hz	50/60Hz	50/60Hz	50/60Hz	50/60Hz	50/60Hz
Output voltage DC	12.0V	12.0V	12.0V	12.0V	12.0V	12.0V	12.0V	12.0V	12.0V	12.0V	12.0V	12.0V
F Output current	1.0A	1.5A	2.0A	2.5A	3.0A	1.0A	1.5A	2.0A	3.0A	2.0A	2.5A	3.0A
G Output power	12.0W	18.0W	24.0W	30.0W	36.0W	12.0W	18.0W	24.0W	36.0W	24.0W	30.0W	36.0W
H Average active efficiency	84.9%	86.2%	87.6%	87.8%	89.8%	83.7%	85.4%	88.6%	88.2%	87.8%	89.5%	89.3%
I Efficiency at low load 10%	73.6%	78.0%	81.3%	83.3%	83.7%	74.5%	80.5%	86.4%	85.4%	85.4%	84.7%	87.7%
J No-load power consumption	0.07W	0.07W	0.07W	0.07W	0.07W	0.07W	0.10W	0.07W	0.10W	0.10W	0.08W	0.10W

External power supply (Power Adapter) information. For more update, please visit [www.draytek.com](http://www.draytek.com).

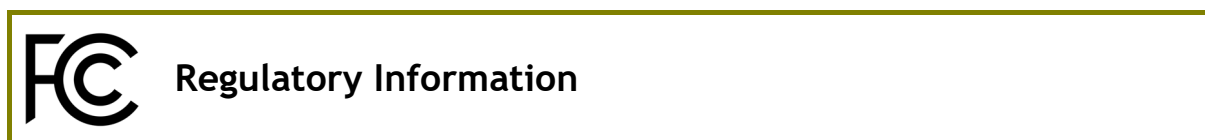

### Federal Communication Commission Interference Statement

This equipment has been tested and found to comply with the limits for a Class B digital device, pursuant to Part 15 of the FCC Rules. These limits are designed to provide reasonable protection against harmful interference in a residential installation. This equipment generates, uses and can radiate radio frequency energy and, if not installed and used in accordance with the instructions, may cause harmful interference to radio communications. However, there is no guarantee that interference will not occur in a particular installation. If this equipment does cause harmful interference to radio or television reception, which can be determined by turning the equipment off and on, the user is encouraged to try to correct the interference by one of the following measures:

- Reorient or relocate the receiving antenna.
- Increase the separation between the equipment and receiver.
- Connect the equipment into an outlet on a circuit different from that to which the receiver is connected.
- Consult the dealer or an experienced radio/TV technician for help.

This device complies with Part 15 of the FCC Rules. Operation is subject to the following two conditions:

- (1) This device may not cause harmful interference, and
- (2) This device may accept any interference received, including interference that may cause undesired operation.

USA Local Representative	Company name	ABP International Inc.		
	Address	13988 Diplomat Drive Suite 180 Dallas TX 75234		
	ZIP Code	75234	E-mail	itadmin@abptech.com
	Contact Person	Mr. Henry N Castillo	Tel.	(972)831-1600 140

Caution:

Any changes or modifications not expressly approved by the grantee of this device could void the user's authority to operate the equipment.

Any changes or modifications not expressly approved by the party responsible for compliance could void the user's authority to operate this equipment.

This transmitter must not be co-located or operating in conjunction with any other antenna or transmitter.

Radiation Exposure Statement: This equipment complies with FCC radiation exposure limits set forth for an uncontrolled environment. This equipment should be installed and operated with minimum distance 20cm between the radiator & your body.

The antenna/transmitter should be kept at least 20 cm away from human body.

More update, please visit [www.draytek.com](http://www.draytek.com).



## **Table of Contents**

<b>1. Package Content .....</b>	<b>1</b>
<b>2. Panel Explanation.....</b>	<b>2</b>
2.1 Vigor2865L .....	2
2.2 Vigor2865ac / Vigor2865Lac / Vigor2865ax .....	4
2.3 Vigor2865Vac.....	8
2.4 Vigor2865L-5G / Vigor2865Lax-5G .....	10
<b>3. Hardware Installation .....</b>	<b>14</b>
3.1 Network Connection .....	14
3.2 Wall-Mounted Installation .....	15
3.3 Antenna Installation (for “L” model).....	16
Warning .....	17
<b>4. Software Configuration .....</b>	<b>18</b>
4.1 Quick Start Wizard for Network Connection.....	18
<b>5. Customer Service .....</b>	<b>24</b>
Be a Registered Owner .....	24
Firmware & Tools Updates .....	24



# 1. Package Content

Take a look at the package content. If there is anything missed or damaged, please contact DrayTek or dealer immediately. Besides, the content is subject to the real package.



Vigor router & Quick Start Guide

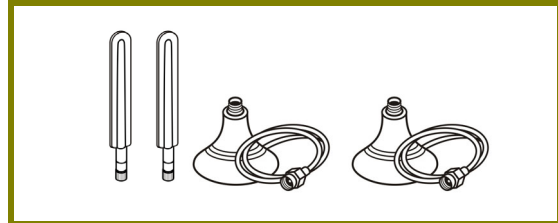

2 sets (Antenna + Extension Base) for Vigor2865L, Vigor2865Lac models

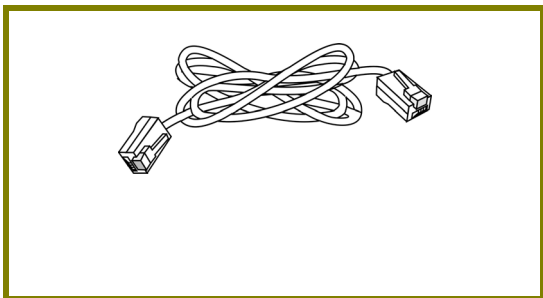

RJ-45 to RJ-45 Cable (Annex B)

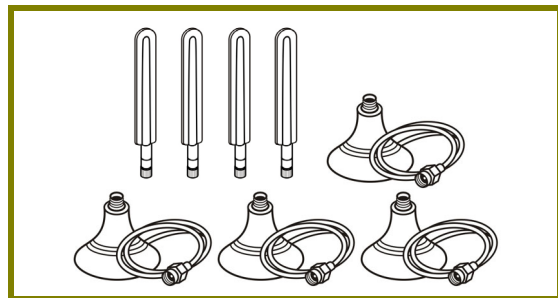

4 sets (Antenna + Extension Base) for Vigor2865L-5G, Vigor2865Lax-5G models

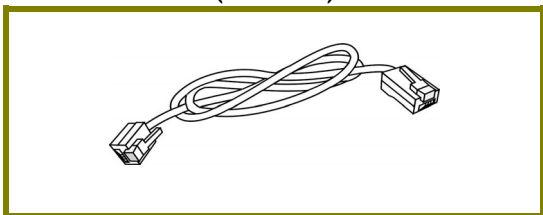

RJ-11 to RJ-45 Cable (Annex B)  
RJ-11 to RJ-11 Cable (Annex A)

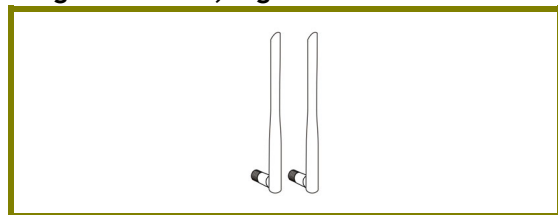

Antenna (ac/ax models)

The type of the power adapter depends on the country that the router will be installed. The maximum power consumption is **32 Watts**.

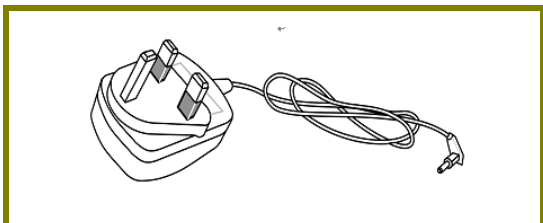

UK-type Power Adapter

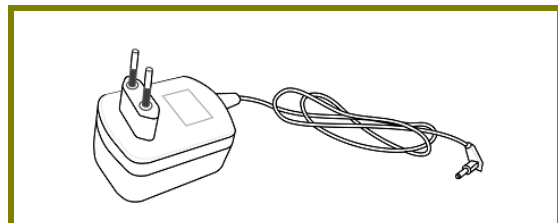

EU-type Power Adapter

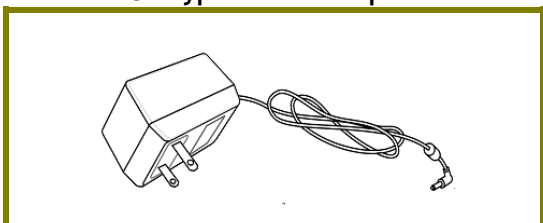

USA/Taiwan-type Power Adapter

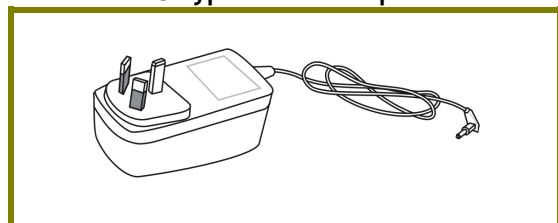

AU/NZ-type Power Adapter

## 2. Panel Explanation

### 2.1 Vigor2865L

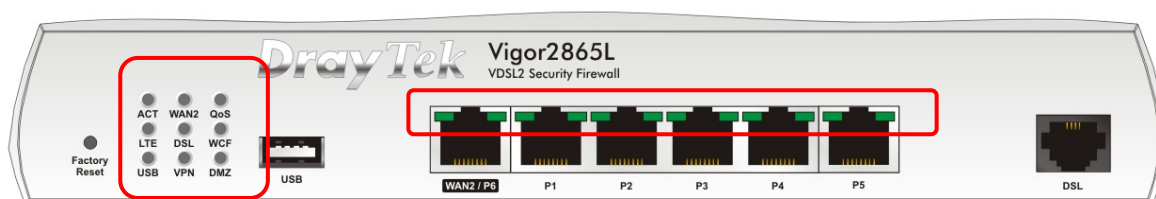

LED	Status	Explanation	
ACT	Off	The router is powered off.	
	Blinking	The router is powered on and running normally.	
WAN2	On	Internet connection is ready.	
	Off	Internet connection is not ready.	
	Blinking	The data is transmitting.	
QoS	On	The QoS function is active.	
	Off	The QoS function is inactive.	
LTE	On	LTE device is connected and ready for use.	
	Off	LTE device is not detected, or has serious problem (e.g., no SIM card, SIM pin error, SIM deactivated, and etc.).	
	Blinking	Slowly: LTE device is in dialing up. Quickly: The data is transmitting.	
DSL	On	The router is ready to access Internet through DSL link.	
	Blinking	Slowly: The DSL connection is ready. Quickly: The connection is training.	
WCF	On	The Web Content Filter is active. (It is enabled from <b>Firewall &gt;&gt; General Setup</b> ).	
	Off	WCF is disabled.	
USB	On	USB device is connected and ready for use.	
	Off	No USB device is connected.	
	Blinking	The data is transmitting.	
VPN	On	The VPN tunnel is active.	
	Off	VPN services are disabled	
	Blinking	Traffic is passing through VPN tunnel.	
DMZ	On	The DMZ function is enabled.	
	Off	The DMZ function is disabled.	
	Blinking	The data is transmitting.	
<b>LED on Connector</b>			
WAN2 / P6	Left LED	On	The port is connected.
		Off	The port is disconnected.
		Blinking	The data is transmitting.

LAN P1~P5	Right LED	On	The port is connected with 1000Mbps.
		Off	The port is connected with 10/100Mbps.
	Left LED	On	The port is connected.
		Off	The port is disconnected.
		Blinking	The data is transmitting.
	Right LED	On	The port is connected with 1000Mbps.
Off		The port is connected with 10/100Mbps.	

The port “WAN2 / P6” is switchable. It can be used for LAN connection or WAN connection according to the settings configured in WUI.

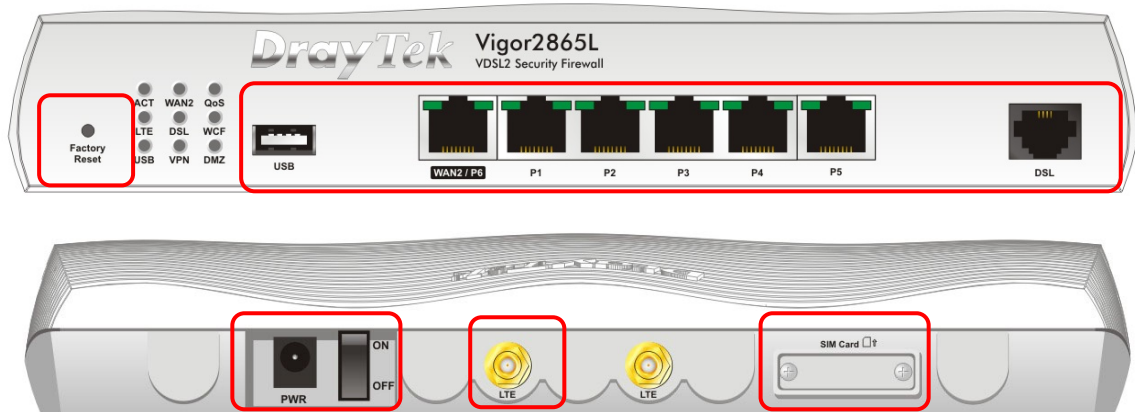

Interface	Description
Factory Reset	Restore the default settings. Usage: Turn on the router (ACT LED is blinking). Press the hole and keep for more than 5 seconds. When you see the ACT LED begins to blink rapidly than usual, release the button. Then the router will restart with the factory default configuration.
USB	Connector for a USB device (for 3G/4G USB Modem or printer or thermometer).
WAN2 / P6	Connector for local network devices or modem for accessing Internet.
LAN P1-P5	Connectors for local network devices.
DSL	Connector for accessing the Internet.
PWR	Connector for a power adapter.
ON/OFF	Power Switch.
	Connector for installing LTE antennas.
SIM Card	Slots for installing SIM card(s).

## 2.2 Vigor2865ac / Vigor2865Lac / Vigor2865ax

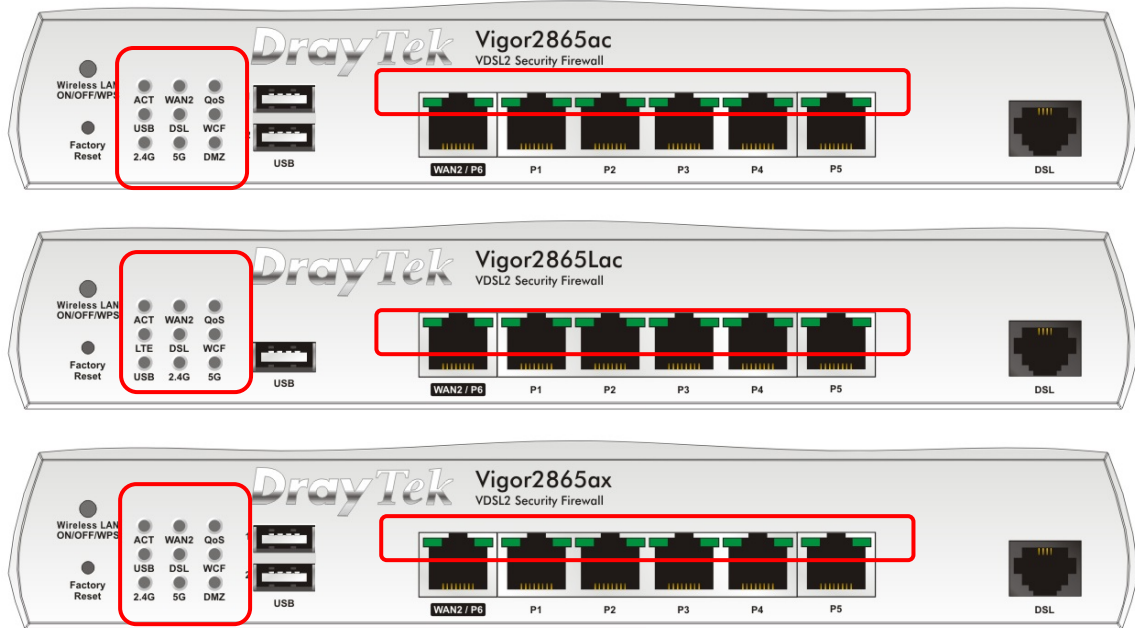

LED	Status	Explanation
ACT	Off	The router is powered off.
	Blinking	The router is powered on and running normally.
WAN2	On	Internet connection is ready.
	Off	Internet connection is not ready.
	Blinking	The data is transmitting.
QoS	On	The QoS function is active.
	Off	The QoS function is inactive.
USB	On	USB device is connected and ready for use.
	Off	No USB device is connected.
	Blinking	The data is transmitting.
LTE	On	LTE device is connected and ready for use.
	Off	LTE device is not detected, or has serious problem (e.g., no SIM card, SIM pin error, SIM deactivated, and etc.).
	Blinking	Slowly: LTE device is in dialing up. Quickly: The data is transmitting.
DSL	On	The router is ready to access Internet through DSL link.
	Blinking	Slowly: The DSL connection is ready. Quickly: The connection is training.
WCF	On	The Web Content Filter is active. (It is enabled from <b>Firewall &gt;&gt; General Setup</b> ).
	Off	WCF is disabled.
2.4G/5G	On	2.4G/5G: Wireless access point with bandwidth of 2.4GHz/5GHz is ready.

		WLAN: Wireless access point is ready.
	Off	Wireless function is disabled.
	Blinking	It will blink slowly while wireless traffic goes through. ACT and WLAN LEDs blink quickly and simultaneously when WPS is working, and will return to normal condition after two minutes. (You need to setup WPS within 2 minutes.)
DMZ	On	The DMZ function is enabled.
	Off	The DMZ function is disabled.
	Blinking	The data is transmitting.



**LED on Connector**

WAN2 / P6	Left LED	On	The port is connected.
		Off	The port is disconnected.
		Blinking	The data is transmitting.
	Right LED	On	The port is connected with 1000Mbps.
		Off	The port is connected with 10/100Mbps.
	LAN P1~P5	Left LED	On
Off			The port is disconnected.
Blinking			The data is transmitting.
Right LED		On	The port is connected with 1000Mbps.
		Off	The port is connected with 10/100Mbps

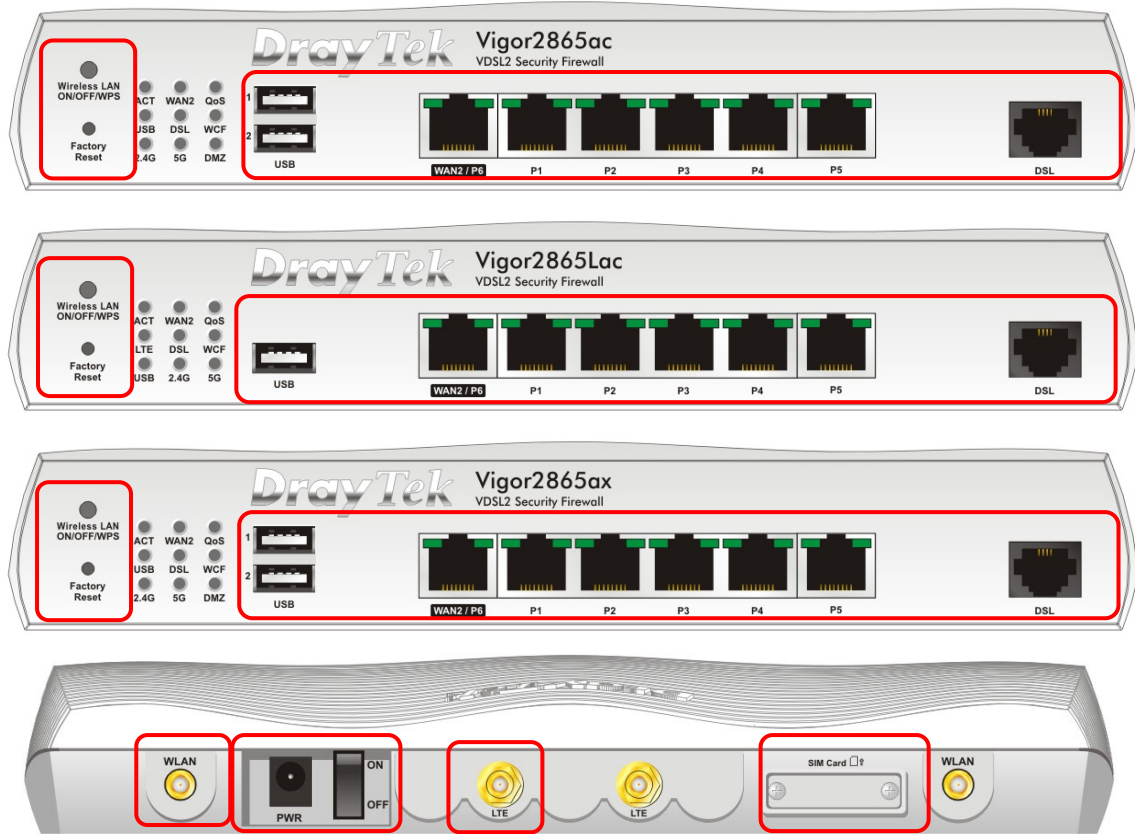
The port “WAN2 / P6” is switchable. It can be used for LAN connection or WAN connection according to the settings configured in WUI.



Interface	Description
Wireless LAN ON/OFF/WPS	<p>Wireless band will be switched /changed according to the button pressed and released. For example,</p> <ul style="list-style-type: none"> <li>● 2.4G (On) and 5G (On) - in default.</li> <li>● 2.4G (Off) and 5G (On) - pressed and released the button once.</li> <li>● 2.4G (On) and 5G (Off) - pressed and released the button twice.</li> <li>● 2.4G (Off) and 5G (Off) - pressed and released the button three times.</li> </ul> <p>When WPS function is enabled by web user interface, press this button for more than 2 seconds to wait for client's device making network connection through WPS.</p>
Factory Reset	<p>Restore the default settings. Usage: Turn on the router (ACT LED is blinking). Press the hole and keep for more than 5 seconds. When you see the ACT LED begins to blink rapidly than usual, release the button. Then the router will restart with the factory default configuration.</p>
USB1~2 / USB	<p>Connector for a USB device (for 3G/4G USB Modem or printer or thermometer).</p>
WAN2 / P6	<p>Connector for local network devices or modem for accessing Internet.</p>
LAN P1-P5	<p>Connectors for local network devices.</p>

DSL	Connector for accessing the Internet.
	Connector for installing WLAN antennas. (For ac/ax model).
PWR	Connector for a power adapter.
ON/OFF	Power Switch.
	Connector for installing LTE antennas. (For L model).
SIM Card	Slots for installing SIM card(s) (for Vigor2865Lac only).

## 2.3 Vigor2865Vac

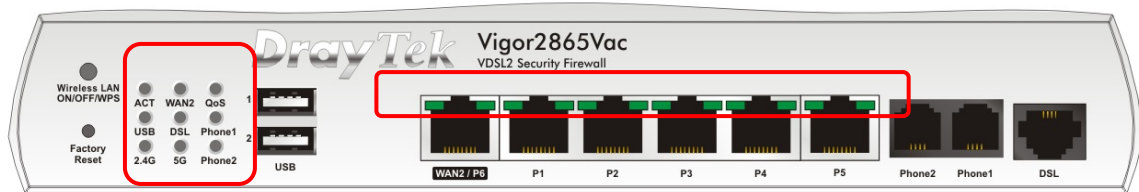

LED	Status	Explanation
ACT	Off	The router is powered off.
	Blinking	The router is powered on and running normally.
WAN2	On	Internet connection is ready.
	Off	Internet connection is not ready.
	Blinking	The data is transmitting.
QoS	On	The QoS function is active.
	Off	The QoS function is inactive.
USB	On	USB device is connected and ready for use.
	Off	No USB device is connected.
	Blinking	The data is transmitting.
DSL	On	The router is ready to access Internet through DSL link.
	Blinking	Slowly: The DSL connection is ready. Quickly: The connection is training.
Phone1/2	On	The phone connected to this port is off-hook.
	Off	The phone connected to this port is on-hook.
	Blinking	A phone call comes.
2.4G/5G	On	2.4G/5G: Wireless access point with bandwidth of 2.4GHz/5GHz is ready. WLAN: Wireless access point is ready.
	Off	Wireless function is disabled.
	Blinking	It will blink slowly while wireless traffic goes through. ACT and WLAN LEDs blink quickly and simultaneously when WPS is working, and will return to normal condition after two minutes. (You need to setup WPS within 2 minutes.)

### LED on Connector

WAN2 / P6	Left LED	On	The port is connected.
		Off	The port is disconnected.
		Blinking	The data is transmitting.
	Right LED	On	The port is connected with 1000Mbps.
		Off	The port is connected with 10/100Mbps.
		Blinking	The data is transmitting.
LAN P1~P5	Left LED	On	The port is connected.
		Off	The port is disconnected.
		Blinking	The data is transmitting.



	Right LED	On	The port is connected with 1000Mbps.
		Off	The port is connected with 10/100Mbps

The port “WAN2 / P6” is switchable. It can be used for LAN connection or WAN connection according to the settings configured in WUI.

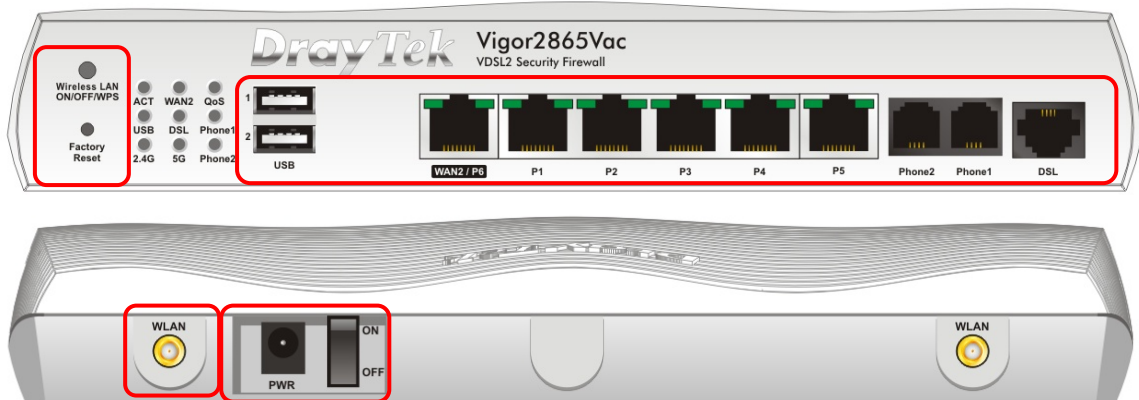

Interface	Description
Wireless LAN ON/OFF/WPS	<p>Wireless band will be switched /changed according to the button pressed and released. For example,</p> <ul style="list-style-type: none"> <li>● 2.4G (On) and 5G (On) - in default.</li> <li>● 2.4G (Off) and 5G (On) - pressed and released the button once.</li> <li>● 2.4G (On) and 5G (Off) - pressed and released the button twice.</li> <li>● 2.4G (Off) and 5G (Off) - pressed and released the button three times.</li> </ul> <p>When WPS function is enabled by web user interface, press this button for more than 2 seconds to wait for client’s device making network connection through WPS.</p>
Factory Reset	Restore the default settings. Usage: Turn on the router (ACT LED is blinking). Press the hole and keep for more than 5 seconds. When you see the ACT LED begins to blink rapidly than usual, release the button. Then the router will restart with the factory default configuration.
USB1~2	Connector for a USB device (for 3G/4G USB Modem or printer or thermometer).
WAN2 / P6	Connector for local network devices or modem for accessing Internet.
LAN P1-P5	Connectors for local network devices.
Phone 1/2	Connector for analog phone(s).
DSL	Connector for accessing the Internet.
	Connector for installing WLAN antennas.
PWR	Connector for a power adapter.
ON/OFF	Power Switch.

## 2.4 Vigor2865L-5G / Vigor2865Lax-5G

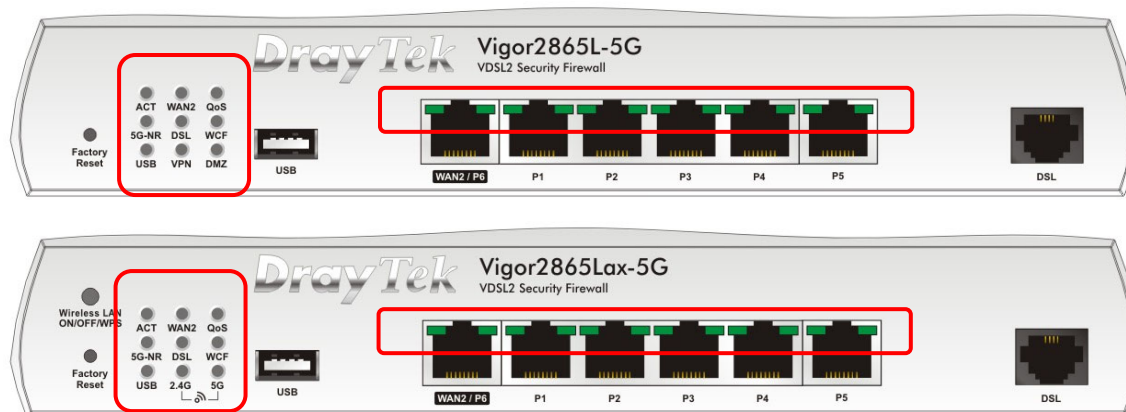

LED	Status	Explanation
ACT	Off	The router is powered off.
	Blinking	The router is powered on and running normally.
WAN2	On	Internet connection is ready.
	Off	Internet connection is not ready.
	Blinking	The data is transmitting.
QoS	On	The QoS function is active.
	Off	The QoS function is inactive.
5G-NR	On	5G-NR device is connected and ready for use.
	Off	5G-NR device is not detected, or has serious problem (e.g., no SIM card, SIM pin error, SIM deactivated, and etc.).
	Blinking	Slowly: 5G-NR device is in dialing up. Quickly: The data is transmitting.
DSL	On	The router is ready to access Internet through DSL link.
	Blinking	Slowly: The DSL connection is ready. Quickly: The connection is training.
WCF	On	The Web Content Filter is active. (It is enabled from <b>Firewall &gt;&gt; General Setup</b> ).
	Off	WCF is disabled.
USB	On	USB device is connected and ready for use.
	Off	No USB device is connected.
	Blinking	The data is transmitting.
VPN	On	The VPN tunnel is active.
	Off	VPN services are disabled
	Blinking	Traffic is passing through VPN tunnel.
DMZ	On	The DMZ function is enabled.
	Off	The DMZ function is disabled.
	Blinking	The data is transmitting.
2.4G/5G	On	2.4G/5G: Wireless access point with bandwidth of 2.4GHz/5GHz is ready.

		WLAN: Wireless access point is ready.
	Off	Wireless function is disabled.
	Blinking	It will blink slowly while wireless traffic goes through. ACT and WLAN LEDs blink quickly and simultaneously when WPS is working, and will return to normal condition after two minutes. (You need to setup WPS within 2 minutes.)



**LED on Connector**

WAN2 / P6	Left LED	On	The port is connected.
		Off	The port is disconnected.
		Blinking	The data is transmitting.
	Right LED	On	The port is connected with 1000Mbps.
		Off	The port is connected with 10/100Mbps.
		Blinking	The data is transmitting.
LAN P1~P5	Left LED	On	The port is connected.
		Off	The port is disconnected.
		Blinking	The data is transmitting.
	Right LED	On	The port is connected with 1000Mbps.
		Off	The port is connected with 10/100Mbps
		Blinking	The data is transmitting.

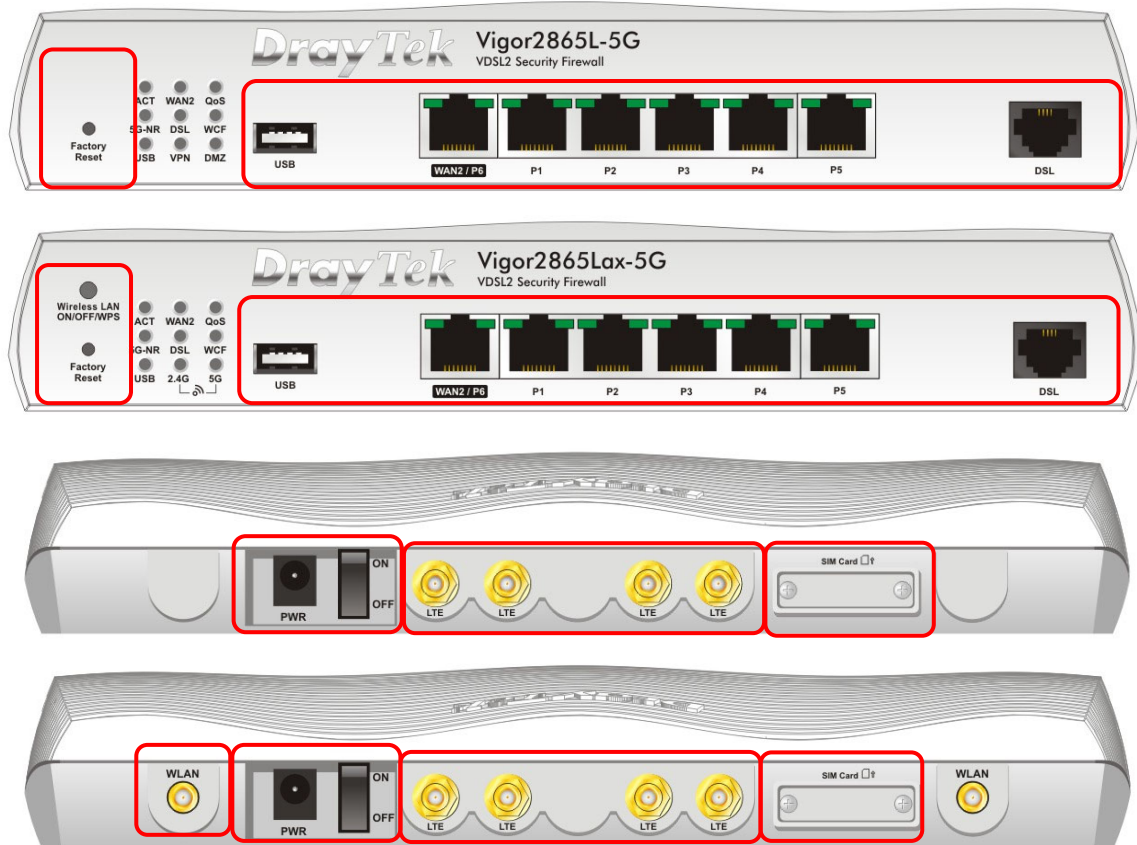
The port “WAN2 / P6” is switchable. It can be used for LAN connection or WAN connection according to the settings configured in WUI.



Interface	Description
Wireless LAN ON/OFF/WPS	<p>Wireless band will be switched /changed according to the button pressed and released. For example,</p> <ul style="list-style-type: none"> <li>● 2.4G (On) and 5G (On) - in default.</li> <li>● 2.4G (Off) and 5G (On) - pressed and released the button once.</li> <li>● 2.4G (On) and 5G (Off) - pressed and released the button twice.</li> <li>● 2.4G (Off) and 5G (Off) - pressed and released the button three times.</li> </ul> <p>When WPS function is enabled by web user interface, press this button for more than 2 seconds to wait for client's device making network connection through WPS.</p>
Factory Reset	<p>Restore the default settings. Usage: Turn on the router (ACT LED is blinking). Press the hole and keep for more than 5 seconds. When you see the ACT LED begins to blink rapidly than usual, release the button. Then the router will restart with the factory default configuration.</p>
USB1~2 / USB	<p>Connector for a USB device (for 3G/4G USB Modem or printer or thermometer).</p>
WAN2 / P6	<p>Connector for local network devices or modem for accessing Internet.</p>
LAN P1-P5	<p>Connecters for local network devices.</p>

DSL	Connector for accessing the Internet.
	Connector for installing WLAN antennas. (For ac/ax model).
PWR	Connector for a power adapter.
ON/OFF	Power Switch.
	Connector for installing LTE antennas.
SIM Card	Slots for installing SIM card(s).

### 3. Hardware Installation

This section will guide you to install the router through hardware connection and configure the router's settings through web browser.

Before starting to configure the router, you have to connect your devices correctly. (For the hardware connection, we take "ac" model as an example.)

#### 3.1 Network Connection

1. Connect the DSL interface to the land line jack with a DSL line cable, or Connect the cable Modem/DSL Modem/Media Converter to the WAN port of router with Ethernet cable (RJ-45).
2. Connect one end of an Ethernet cable (RJ-45) to one of the LAN ports of the router and the other end of the cable (RJ-45) into the Ethernet port on your computer.
3. Connect one end of the power adapter to the router's power port on the rear panel, and the other side into a wall outlet.
4. Power on the device by pressing down the power switch on the rear panel.
5. The system starts to initiate. After completing the system test, the **ACT** LED will light up and start blinking. (For the detailed information of LED status, please refer to section 2. Panel Explanation)

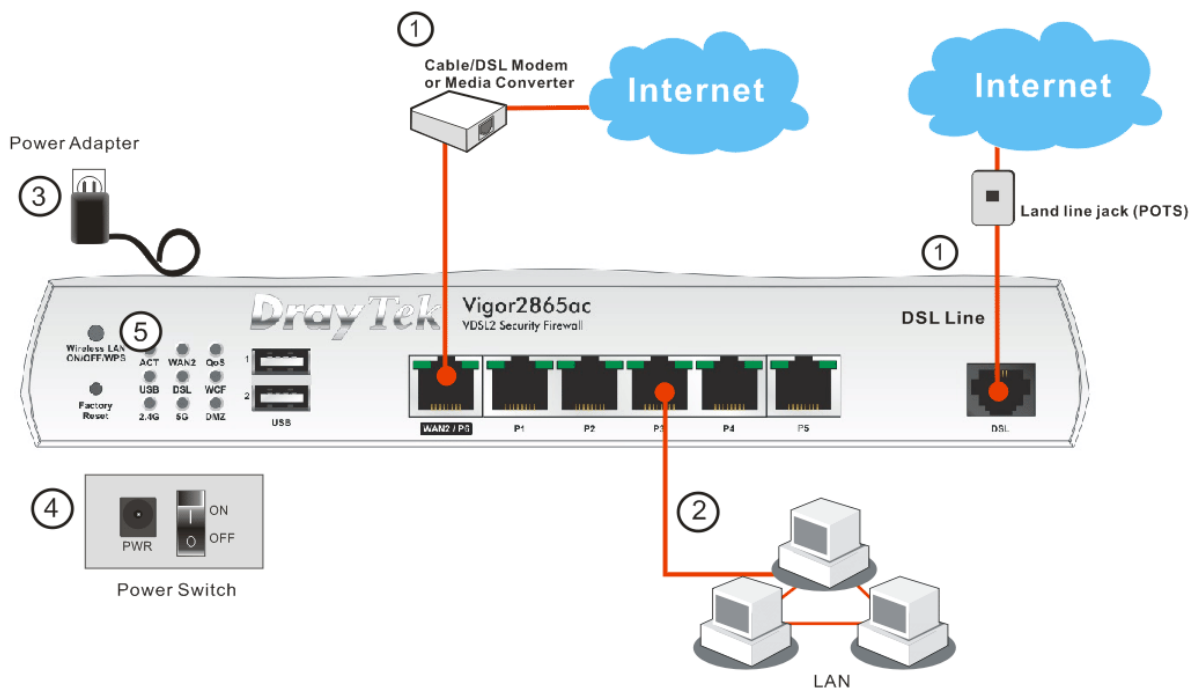

### 3.2 Wall-Mounted Installation

Vigor router has keyhole type mounting slots on the underside.

1. Drill two holes on the wall. The distance between the holes shall be 168mm.
2. Fit screws into the wall using the appropriate type of wall plug.

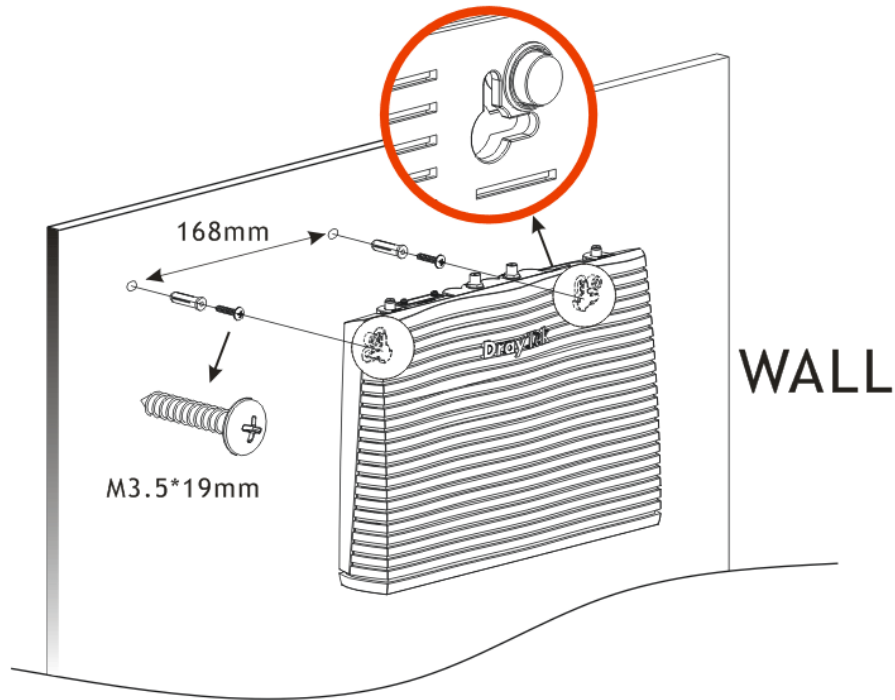

**Note**

The recommended drill diameter shall be 6.5mm (1/4").

3. When you finished about procedure, the router has been mounted on the wall firmly.

### 3.3 Antenna Installation (for “L” model)

Antenna must be installed on the extension base before connecting to Vigor router.

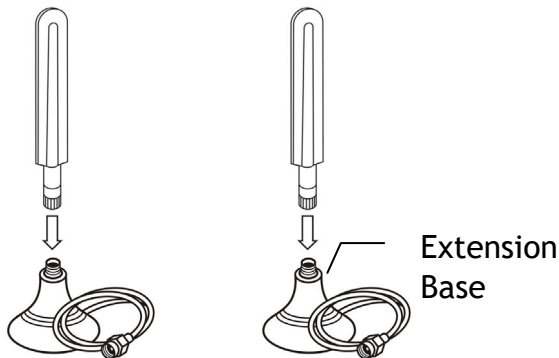

The number of antenna used for LTE and 5G-NR models are different.

LTE Model

2 sets (Antenna + Extension Base)

5G-NR Model

4 sets (Antenna + Extension Base)



The antenna with an extension base on the Vigor router must be installed correctly. If only one antenna shall be installed, please use the connector (main signal connector) near the power switch.

LTE Model

5G-NR Model

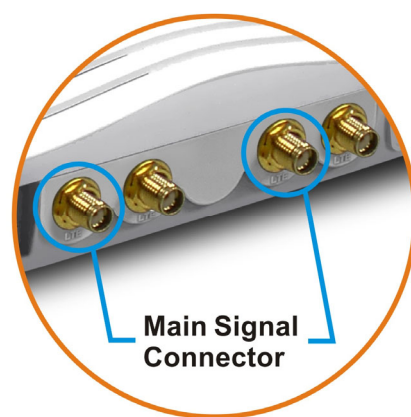



For installing the SIM card into the card slot, here, we take Vigor2865Lac as an example.

- (1) Assemble the extension base with the antenna.
- (2) While installing the SIM card into the card slot, note that the back plate of the SIM card slot must be removed first.
- (3) Assemble the SIM1 and SIM2 with the card cassette. Later insert the cassette into the SIM card slot and the direction of card notch must be on the left side.

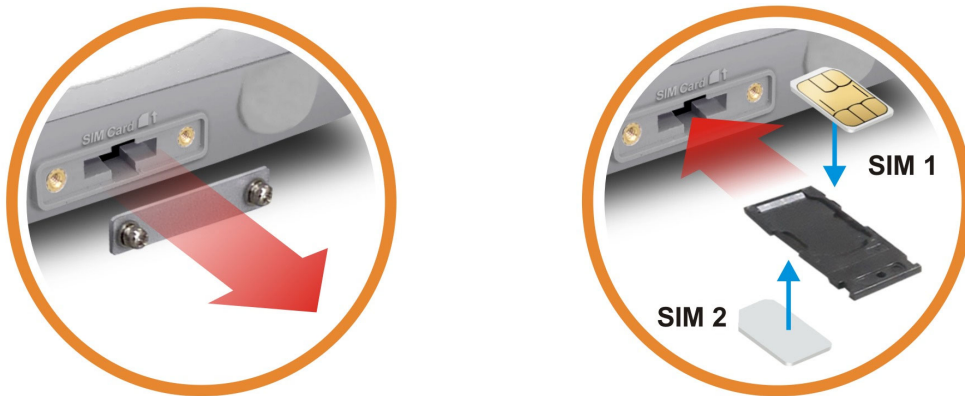

### Warning

There are two types of antennas provided for Vigor2865Lac, which must be installed in different locations carefully and correctly. Wrong installation might cause bad signal of wireless connection. Therefore, pay attention to the installation of antennas by referring to the following illustration.

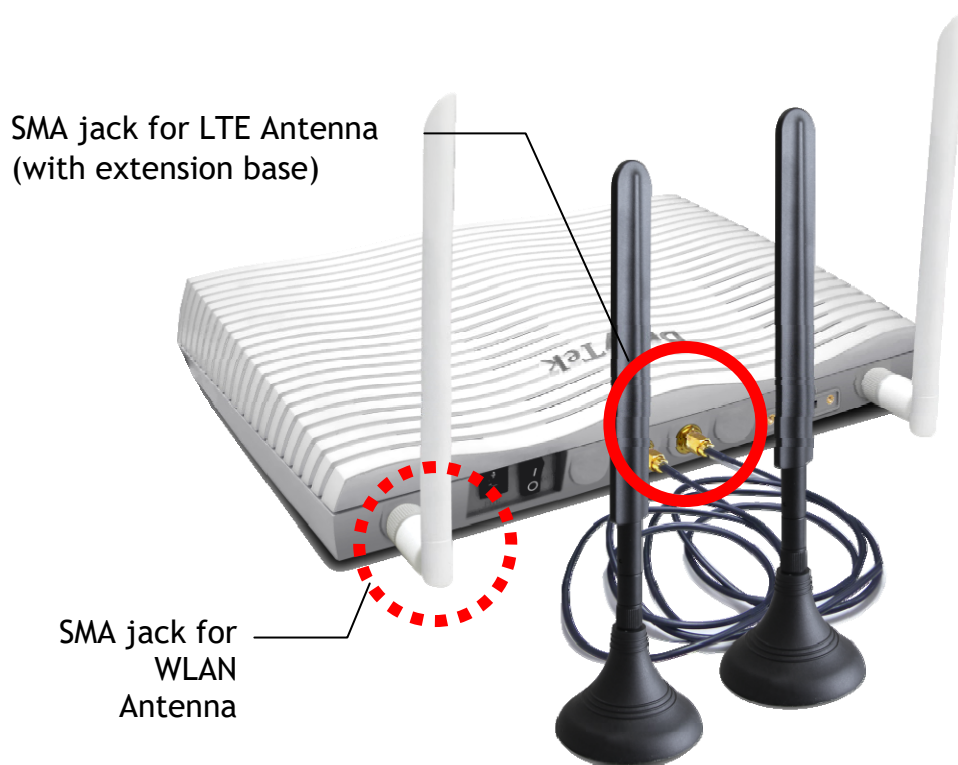

## 4. Software Configuration

To access Internet, please finish basic configuration after completing the hardware installation.

### 4.1 Quick Start Wizard for Network Connection

The **Quick Start Wizard** is designed for you to easily set up your router for Internet access. You can directly access the **Quick Start Wizard** via Web Configurator. Make sure your PC connects to the router correctly.



#### Note

You may either simply set up your computer to get IP dynamically from the router or set up the IP address of the computer to be the same subnet as the **default IP address of Vigor router 192.168.1.1**. For the detailed information, please refer to - Trouble Shooting of the user's guide.

Open a web browser on your PC and type <http://192.168.1.1>. A pop-up window will open to ask for username and password.

Please enter “admin/admin” as the Username/Password and click **Login**.

Next, the following page will appear. You must change the login password before accessing the web user interface. Please set a password with the highest level of strength for network security.

For security reason, you must change the password before proceeding to the router webpage

#### New Password

Password	*****
Confirm Password	*****

Password Strength:

Weak Medium **Strong**

Strong password requirements:

1. Minimal length is 8 characters.
2. Must use at least 1 Upper and 1 lower character.
3. Must use at least 1 numeric or special character.
4. The Password cannot contain only the character "\*".

OK



### Note

If you fail to access to the web configuration, please go to “Trouble Shooting” on User’s Guide for detecting and solving your problem.

Now, the Main Screen will pop up. Click **Wizards>>Quick Start Wizard**.

**System Information**

Model Name	Vigor2865Lax-5G	System Uptime	2 days 17:47:05
Router Name	DrayTek	Current Time	Mon Jan 03 2000 17:47:01
Firmware Version	4.4.5_STD	Build Date/Time	Mar 26 2024 10:02:15
DSL Version	8B0F07_A/B/C HW: A	LAN MAC Address	14-49-BC-6D-A0-68

**IPv4 LAN Information**

Line	IP Address	DHCP	Line	IP Address	DHCP
LAN1	192.168.1.1/24	v	LAN2	192.168.2.1/24	v
LAN3	192.168.3.1/24	v	LAN4	192.168.4.1/24	v
LAN5	192.168.5.1/24	v	LAN6	192.168.6.1/24	v
LAN7	192.168.7.1/24	v	LAN8	192.168.8.1/24	v
DMZ PORT	192.168.254.1/24	v	IP Routed Subnet	192.168.0.1/24	v

**IPv4 Internet Access**

Line / Mode	IP Address	MAC Address	Up Time
WAN1	VDSL2 / PPPoE	Disconnected	14-49-BC-6D-A0-69 00:00:00
WAN2	Ethernet / Static IP	Disconnected	14-49-BC-6D-A0-6A 00:00:00
5G-NR	USB / ---	Disconnected	08-A8-C6-00-00-55 00:00:00
WAN6	USB / ---	Disconnected	14-49-BC-6D-A0-6E 00:00:00

**Interface**

DSL	Connected	Down Stream: 0Kbps/Up Stream: 0Kbps
WAN	Connected	0
LAN	Connected	0
WLAN2 4G	Connected	0
WLAN5G	Connected	0
USB	Connected	0



### Note

The home page will change slightly in accordance with the router you have. Here we take Vigor2865Lac as an example.

If your router can be under an environment with high speed NAT, the configuration provide here can help you to deploy and use the router quickly. The first screen of **Quick Start Wizard** is entering login password. After typing the password, please click **Next**.

#### Quick Start Wizard

##### Enter login password

Please enter an alpha-numeric string as your **Password** (Max 83 characters)

Old Password

New Password

Confirm Password

Password Strength: Weak Medium Strong

Strong password requirements:

1. Have at least one upper-case letter and one lower-case letter.
2. Including non-alphanumeric characters is a plus.

Hint: If you want to keep the password unchanged, leave the password blank and press "Next" button to skip this process.

      >

On the next page as shown below, please select the WAN interface that you use. If DSL interface is used, please choose WAN1; if Ethernet interface is used, please choose WAN2; if wireless 2.4G/5G connection is used, please choose WAN3 or WAN4; if 3G USB modem is used, please choose WAN5 or WAN6. Then click **Next** for next step. Each WAN interface will bring up specific configuration page. Here, we take **WAN1** as an example.

Wizards >> Quick Start Wizard

**Select WAN Interface**

Select WAN Interface:	WAN1
Display Name:	
Physical Mode:	ADSL / VDSL2
DSL Mode:	Auto
Physical Type:	Auto negotiation
VLAN Tag insertion(ADSL):	Disable
Tag value	(0-4095)
Priority	(0-7)
VLAN Tag insertion (VDSL2) :	Disable
Tag value	(0-4095)
Priority	(0-7)

Click **Next** to go to the following page. You have to select the appropriate Internet access type **according to the information from your ISP**. For example, you should select PPPoE mode if the ISP provides you PPPoE interface. In addition, the field of **For ADSL Only** will be available only when ADSL is detected. Then click **Next** for next step.

Quick Start Wizard

**Connect to Internet**

**WAN 1**

Protocol	PPPoE / PPPoA
<b>For ADSL Only:</b>	
Encapsulation	PPPoE LLC/SNAP
VPI	0 <input type="button" value=" Auto detect"/>
VCI	38
Fixed IP	<input type="radio"/> Yes <input checked="" type="radio"/> No(Dynamic IP)
IP Address	
Subnet Mask	
Default Gateway	
Primary DNS	8.8.8.8
Second DNS	8.8.4.4

## PPPoE/PPPoA

1. Choose **WAN1** as WAN Interface and click the **Next** button; you will get the following page.

### Quick Start Wizard

---

#### Connect to Internet

<b>WAN 1</b>	
Protocol	PPPoE / PPPoA
<b>For ADSL Only:</b>	
Encapsulation	PPPoE LLC/SNAP
VPI	0 <input type="button" value="Auto detect"/>
VCI	38
Fixed IP	<input type="radio"/> Yes <input checked="" type="radio"/> No(Dynamic IP)
IP Address	<input type="text"/>
Subnet Mask	<input type="text"/>
Default Gateway	<input type="text"/>
Primary DNS	8.8.8.8
Second DNS	8.8.4.4

2. After finished the above settings, simply click **Next**.

### Quick Start Wizard

---

#### Set PPPoE / PPPoA

<b>WAN 1</b>	
Service Name (optional)	CHTI
Username	77494727@hinet.net
Password	*****
Confirm Password	*****

3. Please manually enter the Username/Password provided by your ISP. Then click **Next** for viewing summary of such connection.

Quick Start Wizard

---

Please confirm your settings:

WAN Interface:	WAN1
Physical Mode:	ADSL / VDSL2
VPI:	0
VCI:	38
Protocol / Encapsulation:	PPPoE / LLC
Fixed IP:	No
Primary DNS:	8.8.8.8
Secondary DNS:	8.8.4.4

4. Click **Finish**. A page of **Quick Start Wizard Setup OK!!!** will appear. Then, the system status of this protocol will be shown.
5. Now, you can enjoy surfing on the Internet.

## MPoA / Static or Dynamic IP

1. Choose **WAN1** as WAN Interface and click the **Next** button; you will get the following page.

Quick Start Wizard

---

Connect to Internet

**WAN 1**

Protocol MPoA / Static or Dynamic IP ▼

**For ADSL Only:**

Encapsulation 1483 Bridged IP LLC ▼

VPI  Auto detect

VCI

Fixed IP  Yes  No(Dynamic IP)

IP Address

Subnet Mask

Default Gateway

Primary DNS

Second DNS

2. Please type in the IP address/mask/gateway information originally provided by your ISP. Then click **Next** for viewing summary of such connection.

Quick Start Wizard

---

Please confirm your settings:

WAN Interface:	WAN1
Physical Mode:	ADSL / VDSL2
VPI:	0
VCI:	38
Protocol / Encapsulation:	1483 Bridge LLC
Fixed IP:	No
Primary DNS:	8.8.8.8
Secondary DNS:	8.8.4.4

3. Click **Finish**. A page of **Quick Start Wizard Setup OK!!!** will appear. Then, the system status of this protocol will be shown.
4. Now, you can enjoy surfing on the Internet.

## **5. Customer Service**

If the router cannot work correctly after trying many efforts, please contact your dealer for further help right away. For any questions, please feel free to send e-mail to [support@draytek.com](mailto:support@draytek.com).

### **Be a Registered Owner**

Web registration is preferred. You can register your Vigor router via <https://myvigor.draytek.com>.

### **Firmware & Tools Updates**

Due to the continuous evolution of DrayTek technology, all routers will be regularly upgraded. Please consult the DrayTek web site for more information on newest firmware, tools and documents.

<https://www.draytek.com>