

# DrayTek

## Vigor2927 Series

Dual-WAN Security Router



## USER'S GUIDE

V1.6

# **Vigor2927 Series Dual-WAN Security Router**

## **User's Guide**

Version: 1.6

Firmware Version: V4.4.2.2

(For future update, please visit DrayTek web site)

Date: January 5, 2023

## Copyrights

© All rights reserved. This publication contains information that is protected by copyright. No part may be reproduced, transmitted, transcribed, stored in a retrieval system, or translated into any language without written permission from the copyright holders.

## Trademarks

The following trademarks are used in this document:

- Microsoft is a registered trademark of Microsoft Corp.
- Windows, Windows 7, 8, 10, 11 and Explorer are trademarks of Microsoft Corp.
- Apple and Mac OS are registered trademarks of Apple Inc.
- Other products may be trademarks or registered trademarks of their respective manufacturers.

## Safety Instructions

- Read the installation guide thoroughly before you set up the router.
- The router is a complicated electronic unit that may be repaired only by authorized and qualified personnel. Do not try to open or repair the router yourself.
- Do not place the router in a damp or humid place, e.g. a bathroom.
- The router should be used in a sheltered area, within a temperature range of +5 to +40 Celsius.
- Do not expose the router to direct sunlight or other heat sources. The housing and electronic components may be damaged by direct sunlight or heat sources.
- Do not deploy the cable for LAN connection outdoor to prevent electronic shock hazards.
- Keep the package out of reach of children.
- When you want to dispose of the router, please follow local regulations on conservation of the environment.

## Warranty

- We warrant to the original end user (purchaser) that the router will be free from any defects in workmanship or materials for a period of two (2) years from the date of purchase from the dealer. Please keep your purchase receipt in a safe place as it serves as proof of date of purchase. During the warranty period, and upon proof of purchase, should the product have indications of failure due to faulty workmanship and/or materials, we will, at our discretion, repair or replace the defective products or components, without charge for either parts or labor, to whatever extent we deem necessary to restore the product to proper operating condition. Any replacement will consist of a new or re-manufactured functionally equivalent product of equal value, and will be offered solely at our discretion. This warranty will not apply if the product is modified, misused, tampered with, damaged by an act of God, or subjected to abnormal working conditions. The warranty does not cover the bundled or licensed software of other vendors. Defects which do not significantly affect the usability of the product will not be covered by the warranty. We reserve the right to revise the manual and online documentation and to make changes from time to time in the contents hereof without obligation to notify any person of such revision or changes.

## Be a Registered Owner

- Web registration is preferred. You can register your Vigor router via <https://myvigor.draytek.com>.

## Firmware & Tools Updates

- Due to the continuous evolution of DrayTek technology, all routers will be regularly upgraded. Please consult the DrayTek web site for more information on newest firmware, tools and documents.

<https://www.draytek.com>

## Table of Contents

<b>Part I Installation</b> .....	<b>i</b>
I-1 Introduction .....	1
I-1-1 Indicators and Connectors .....	2
I-1-1-1 Vigor2927 .....	2
I-1-1-2 Vigor2927L .....	4
I-1-1-3 Vigor2927ac / Vigor2927ax / Vigor2927Lac .....	6
I-1-1-4 Vigor2927Vac .....	10
I-1-2 Notes for Antenna Installation (for “L” model) .....	12
I-2 Hardware Installation .....	14
I-2-1 Installing Vigor Router .....	14
I-2-2 Wall-Mounted Installation .....	15
I-2-3 Installing USB Printer to Vigor Router .....	16
I-3 Accessing Web Page .....	23
I-4 Changing Password .....	25
I-5 Dashboard .....	26
I-5-1 Virtual Panel .....	27
I-5-2 Name with a Link .....	28
I-5-3 Status for LTE .....	28
I-5-4 Quick Access for Common Used Menu .....	29
I-5-5 GUI Map .....	30
I-5-6 Web Console .....	31
I-5-7 Config Backup .....	32
I-5-8 Manual Download .....	32
I-5-9 Logout .....	32
I-5-10 Online Status .....	33
I-5-10-1 Physical Connection .....	33
I-5-10-2 Virtual WAN .....	35
I-6 Quick Start Wizard .....	36
I-6-1 For WAN1/WAN2 (Ethernet) .....	37
I-6-2 For WAN3/WAN4 (Wireless 2.4G/Wireless 5G) .....	46
I-6-3 For WAN5/WAN6 (USB) .....	52
I-7 Service Activation Wizard .....	54
I-8 Registering Vigor Router .....	56
<b>Part II Connectivity</b> .....	<b>59</b>
II-1 WAN .....	60
Web User Interface .....	62
II-1-1 General Setup .....	62
II-1-1-1 WAN1/WAN2 (Ethernet) .....	65
II-1-1-2 WAN3/WAN4 (Wireless 2.4G or 5G) .....	67
II-1-1-3 WAN5 / WAN6 (USB) or LTE .....	68
II-1-2 Internet Access .....	70

II-1-2-1 Details Page for PPPoE in WAN1/WAN2 (Physical Mode: Ethernet) .....	73
II-1-2-2 Details Page for Static or Dynamic IP in WAN1/WAN2 (Physical Mode: Ethernet) .....	76
II-1-2-3 Details Page for PPTP/L2TP in WAN1/WAN2 (Physical Mode: Ethernet) .....	80
II-1-2-4 Details Page for WAN3/WAN4 (Physical Mode: Wireless 2.4G/ Wireless 5G) ..	83
II-1-2-5 Details Page for 3G/4G USB Modem (PPP mode) in WAN5 / WAN6 .....	85
II-1-2-6 Details Page for 3G/4G USB Modem (DHCP mode) in WAN5 / WAN6 .....	87
II-1-2-7 Details Page for 3G/4G USB Modem (DHCP mode) in LTE WAN .....	90
II-1-2-8 Details Page for IPv6 - Offline in WAN1/WAN2/WAN5/WAN6 .....	93
II-1-2-9 Details Page for IPv6 - PPP in WAN1/WAN2 .....	94
II-1-2-10 Details Page for IPv6 - TSPC in WAN1/WAN2/WAN5/WAN6 .....	95
II-1-2-11 Details Page for IPv6 - AICCU in WAN1/WAN2/WAN5/WAN6 .....	97
II-1-2-12 Details Page for IPv6 - DHCPv6 Client in WAN1/WAN2 .....	98
II-1-2-13 Details Page for IPv6 - Static IPv6 in WAN1/WAN2 .....	100
II-1-2-14 Details Page for IPv6 - 6in4 Static Tunnel in WAN1/WAN2 .....	101
II-1-2-15 Details Page for IPv6 - 6rd in WAN1/WAN2 .....	103
II-1-3 Multi-VLAN .....	105
II-1-4 WAN Budget .....	110
II-1-4-1 General Setup .....	110
II-1-4-2 Status .....	113
Application Notes .....	114
A-1 How to set up Multi-PVC for triple play deployment? .....	114
II-2 LAN .....	119
Web User Interface .....	121
II-2-1 General Setup .....	121
II-2-1-1 Details Page for LAN1 - Ethernet TCP/IP and DHCP Setup .....	123
II-2-1-2 Details Page for LAN2 ~ LAN8 and DMZ .....	127
II-2-1-3 Details Page for IP Routed Subnet .....	129
II-2-1-4 Details Page for LAN IPv6 Setup .....	131
II-2-1-5 DHCP Server Options .....	134
II-2-2 VLAN .....	136
II-2-3 Bind IP to MAC .....	140
II-2-4 LAN Port Mirror .....	143
II-2-5 Wired 802.1x .....	144
II-2-6 Link Aggregation .....	145
II-3 Hardware Acceleration .....	146
II-4 NAT .....	148
Web User Interface .....	149
II-4-1 Port Redirection .....	149
II-4-2 DMZ Host .....	153
II-4-3 Open Ports .....	156
II-4-4 Port Triggering .....	158
II-4-5 ALG .....	160
II-5 Applications .....	161
Web User Interface .....	163
II-5-1 Dynamic DNS .....	163
II-5-2 LAN DNS / DNS Forwarding .....	169
II-5-3 DNS Security .....	172

II-5-3-1 General Setup .....	172
II-5-3-2 Domain Diagnose .....	173
II-5-4 Schedule.....	174
II-5-5 RADIUS/TACACS+ .....	177
II-5-5-1 External RADIUS.....	177
II-5-5-2 Internal RADIUS .....	179
II-5-5-3 External TACACS+.....	182
II-5-6 Active Directory/LDAP .....	183
II-5-6-1 General Setup .....	183
II-5-6-2 Active Directory / LDAP Profiles .....	184
II-5-7 UPnP .....	186
II-5-8 IGMP.....	187
II-5-8-1 General Setting .....	187
II-5-8-2 Working Status .....	188
II-5-9 Wake on LAN/WAN.....	189
II-5-10 SMS / Mail Alert Service.....	191
II-5-10-1 SMS Alert.....	191
II-5-10-2 Mail Alert .....	192
II-5-11 Bonjour .....	193
II-5-12 High Availability .....	196
II-5-12-1 General Setup.....	197
II-5-12-2 Config Sync .....	199
II-5-13 Local 802.1X General Setup .....	201
Application Notes .....	203
A-1 How to use DrayDDNS?.....	203
A-2 How to Configure Customized DDNS?.....	208
II-6 Routing.....	212
Web User Interface .....	213
II-6-1 Static Route .....	213
II-6-2 Load-Balance /Route Policy .....	218
Diagnose for Route Policy .....	224
II-6-3 BGP .....	228
II-6-3-1 Basic Settings.....	228
II-6-3-2 Static Network .....	229
Application Notes .....	230
A-1 How to set up Address Mapping with Route Policy? .....	230
A-2 How to use destination domain name in a route policy?.....	232
A-3 Introduction to Load Balance/Route Policy .....	234
II-7 LTE.....	236
Web User Interface .....	237
II-7-1 General Settings.....	237
II-7-1-1 SMS Quota .....	237
II-7-1-2 SMS Inbox/Outbox .....	238
II-7-2 SMS Inbox.....	239
II-7-3 Send SMS .....	242
II-7-4 SMS Gateway.....	243

II-7-5 Router Commands .....	247
II-7-6 Status .....	249
<b>Part III Wireless LAN.....</b>	<b>251</b>
III-1 Wireless LAN (2.4GHz/5GHz) .....	252
Web User Interface .....	255
III-1-1 Wireless Wizard.....	255
III-1-2 General Setup .....	259
III-1-3 Security.....	261
III-1-4 Access Control .....	263
III-1-5 WPS.....	265
III-1-6 WDS (for 5GHz) .....	268
III-1-7 Advanced Setting .....	270
III-1-8 Station Control.....	274
III-1-9 Bandwidth Management.....	275
III-1-10 AP Discovery .....	276
III-1-11 Airtime Fairness.....	277
III-1-12 Band Steering (2.4 GHz) .....	279
III-1-13 Roaming .....	283
III-1-14 Station List.....	284
III-2 Mesh Network .....	286
III-2-1 Mesh Wizard.....	287
III-2-2 Mesh Setup .....	291
III-2-3 Mesh Status.....	293
III-2-4 Mesh Discovery .....	294
III-2-5 Basic/Advanced Config Sync .....	295
III-2-6 Support List .....	297
<b>Part IV VoIP.....</b>	<b>299</b>
IV-1 VoIP .....	300
Web User Interface .....	302
IV-1-1 VoIP Wizard .....	302
IV-1-2 General Settings .....	304
IV-1-3 SIP Accounts.....	307
IV-1-3-1 Alias List.....	310
IV-1-4 DialPlan.....	313
IV-1-4-1 Phone Book.....	313
IV-1-4-2 Digit Map .....	314
IV-1-4-3 Call Barring .....	317
IV-1-4-4 Regional .....	319
IV-1-5 Phone Settings.....	321
IV-1-6 Status .....	325
IV-1-7 Diagnostics.....	327

<i>IV-1-7-1 Caller ID</i> .....	327
<i>IV-1-7-2 Tone</i> .....	327

**Part V VPN ..... 329**

V-1 VPN and Remote Access .....	330
Web User Interface .....	331
V-1-1 VPN Client Wizard .....	331
V-1-2 VPN Server Wizard .....	338
V-1-3 Remote Access Control .....	348
V-1-4 PPP General Setup .....	349
V-1-5 SSL General Setup .....	351
V-1-6 IPsec General Setup .....	353
V-1-7 IPsec Peer Identity .....	356
V-1-8 VPN Matcher Setup .....	358
V-1-9 OpenVPN .....	360
<i>V-1-9-1 OpenVPN Server Setup</i> .....	360
<i>V-1-9-2 Client Config</i> .....	362
<i>V-1-9-3 Import Certificate</i> .....	363
V-1-10 Remote Dial-in User .....	365
V-1-11 LAN to LAN .....	370
V-1-12 VPN Trunk Management .....	380
V-1-13 Connection Management .....	385
V-2 Certificate Management .....	387
Web User Interface .....	388
V-2-1 Local Certificate .....	388
V-2-2 Trusted CA Certificate .....	393
V-2-3 Certificate Backup .....	397
V-2-4 Self-Signed Certificate .....	398
V-2-5 Local Services List .....	399

**Part VI Security ..... 401**

VI-1 Firewall .....	402
Web User Interface .....	404
VI-1-1 General Setup .....	404
VI-1-2 Filter Setup .....	409
VI-1-3 Defense Setup .....	419
<i>VI-1-3-1 DoS Defense</i> .....	419
<i>VI-1-3-2 Spoofing Defense</i> .....	422
VI-1-4 Diagnose .....	423
VI-2 Central Security Management (CSM) .....	426
Web User Interface .....	427
VI-2-1 APP Enforcement Profile .....	427
VI-2-2 APPE Signature Upgrade .....	429



VI-2-3 URL Content Filter Profile .....	431
VI-2-4 Web Content Filter Profile .....	435
VI-2-5 DNS Filter Profile .....	439
Application Notes .....	441
<i>A-1 How to Create an Account for MyVigor</i> .....	441
<i>A-2 How to Block Facebook Service Accessed by the Users via Web Content Filter / URL Content Filter</i> .....	446

## **Part VII Management .....451**

VII-1 System Maintenance .....	452
Web User Interface .....	453
VII-1-1 System Status .....	453
VII-1-2 TR-069 .....	455
<i>VII-1-2-1 ACS and CPE Settings</i> .....	455
<i>VII-1-2-2 Reporting Configuration</i> .....	457
<i>VII-1-2-3 Export Parameters</i> .....	458
VII-1-3 NetFlow .....	458
VII-1-4 Administrator Password .....	459
VII-1-5 User Password.....	463
VII-1-6 Login Page Greeting .....	466
VII-1-7 Configuration Backup.....	468
VII-1-8 Webhook .....	471
VII-1-9 Syslog/Mail Alert .....	472
VII-1-10 Time and Date.....	475
VII-1-11 SNMP.....	476
VII-1-11 Management .....	478
VII-1-12 Panel Control .....	482
VII-1-13 Self-Signed Certificate .....	488
VII-1-14 Reboot System.....	490
VII-1-15 Firmware Upgrade .....	491
VII-1-16 Firmware Backup .....	492
VII-1-17 Internal Service User List.....	493
VII-1-18 Dashboard Control .....	494
VII-2 Bandwidth Management.....	495
Web User Interface .....	496
VII-2-1 Sessions Limit.....	496
VII-2-2 Bandwidth Limit.....	498
VII-2-3 Quality of Service .....	500
VII-2-4 APP QoS.....	506
VII-3 User Management .....	507
Web User Interface .....	508
VII-3-1 General Setup.....	508
VII-3-2 User Profile .....	509

VII-3-3 User Group.....	513
VII-3-4 User Online Status.....	514
Application Notes.....	516
<i>A-1 How to authenticate clients via User Management</i> .....	516
<i>A-2 How to use Landing Page Feature</i> .....	525
VII-4 Hotspot Web Portal.....	529
Web User Interface.....	529
VII-4-1 Profile Setup.....	529
<i>VII-4-1-1 Login Method</i> .....	530
<i>VII-4-1-2 Steps for Configuring a Web Portal Profile</i> .....	531
VII-4-2 User Information.....	550
<i>VII-4-2-1 User Info</i> .....	550
<i>VII-4-2-2 Database Setup</i> .....	551
VII-4-3 Quota Management.....	553
VII-4-4 PIN Generator.....	556
<i>VII-4-4-1 PIN Status</i> .....	556
<i>VII-4-4-2 PIN Generator</i> .....	557
<i>VII-4-4-3 JSON PIN Generator</i> .....	558
<i>VII-4-4-4 PIN Voucher</i> .....	559
Application Notes.....	561
<i>A-1 How to create Facebook APP for Web Portal Authentication?</i> .....	561
<i>A-2 How to create Google APP for Web Portal Authentication?</i> .....	567
VII-5 Central Management (VPN).....	569
Web User Interface.....	570
VII-5-1 General Setup.....	570
<i>VII-5-1-1 General Settings</i> .....	570
<i>VII-5-1-2 IPsec VPN Settings</i> .....	571
VII-5-2 CPE Management.....	572
<i>VII-5-2-1 Managed Device List</i> .....	572
<i>VII-5-2-2 CPE Maintenance</i> .....	575
<i>VII-5-2-3 Google Map</i> .....	577
VII-5-3 VPN Management.....	579
VII-5-4 Log & Alert.....	580
Application Notes.....	581
<i>A-1 CVM Application - How to manage the CPE (router) through Vigor2927 series?</i> .....	581
<i>A-2 CVM Application - How to upgrade CPE firmware through Vigor2927 series?</i> .....	585
VII-6 Central Management (AP).....	588
Web User Interface.....	589
VII-6-1 Dashboard.....	589
VII-6-2 Status.....	590
VII-6-3 WLAN Profile.....	591
VII-6-4 AP Maintenance.....	597
VII-6-5 Traffic Graph.....	598
VII-6-6 Event Log.....	599
VII-6-7 Total Traffic.....	600
VII-6-8 Station Number.....	600

VII-6-9 Load Balance .....	601
VII-7 Central Management (Switch) .....	603
Web User Interface .....	604
VII-7-1 Status .....	604
VII-7-1-1 Switch Status .....	604
VII-7-1-2 Switch Hierarchy .....	606
VII-7-1-3 Detailed Info .....	607
VII-7-1-4 TR069 Setting .....	608
VII-7-2 Profile .....	610
VII-7-3 Group .....	613
VII-7-4 Maintenance .....	615
VII-7-5 Alert and Log .....	616
VII-7-5-1 Alert Setup .....	616
VII-7-5-2 Switch and Port Setup .....	617
VII-7-5-3 Alert Logs .....	618
VII-7-6 Database Setup .....	619
VII-7-7 Support List .....	620
VII-8 Central Management (External Devices) .....	621

**Part VIII Others ..... 623**

VIII-1 Objects Settings .....	624
Web User Interface .....	625
VIII-1-1 IP Object .....	625
VIII-1-2 IP Group .....	628
VIII-1-3 IPv6 Object .....	630
VIII-1-4 IPv6 Group .....	632
VIII-1-5 Service Type Object .....	634
VIII-1-6 Service Type Group .....	636
VIII-1-7 Keyword Object .....	638
VIII-1-8 Keyword Group .....	640
VIII-1-9 File Extension Object .....	641
VIII-1-10 SMS/Mail Service Object .....	643
VIII-1-11 Notification Object .....	648
VIII-1-12 String Object .....	650
VIII-1-13 Country Object .....	651
VIII-1-14 Objects Backup/Restore .....	653
Application Notes .....	654
A-1 How to Send a Notification to Specified Phone Number via SMS Service in WAN Disconnection .....	654
VIII-2 USB Application .....	658
Web User Interface .....	659
VIII-2-1 USB General Settings .....	659
VIII-2-2 USB User Management .....	660
VIII-2-3 File Explorer .....	662

VIII-2-4 USB Device Status.....	663
VIII-2-5 Temperature Sensor .....	664
VIII-2-6 Modem Support List.....	667
VIII-2-7 SMB Client Support List.....	668
Application Notes .....	669
<i>A-1 How can I get the files from USB storage device connecting to Vigor router? ...</i>	<i>669</i>
<b>Part IX Troubleshooting .....</b>	<b>673</b>
IX-1 Diagnostics .....	674
Web User Interface .....	675
IX-1-1 Dial-out Triggering.....	675
IX-1-2 Routing Table.....	676
IX-1-3 ARP Cache Table .....	677
IX-1-4 IPv6 Neighbour Table .....	678
IX-1-5 DHCP Table .....	679
IX-1-6 NAT Sessions Table .....	680
IX-1-7 DNS Cache Table .....	681
IX-1-8 Ping Diagnosis .....	682
IX-1-9 Data Flow Monitor .....	683
IX-1-10 Traffic Graph .....	686
IX-1-11 VPN Graph.....	687
IX-1-12 Trace Route .....	688
IX-1-13 Syslog Explorer .....	689
IX-1-14 IPv6 TSPC Status .....	690
IX-1-15 High Availability Status .....	690
IX-1-16 Authentication Information .....	692
IX-1-17 DoS Flood Table .....	694
IX-1-18 Route Policy Diagnosis.....	695
IX-2 Checking If the Hardware Status Is OK or Not.....	697
IX-3 Checking If the Network Connection Settings on Your Computer Is OK or Not.....	698
IX-4 Pinging the Router from Your Computer .....	701
IX-5 Checking If the ISP Settings are OK or Not.....	703
IX-6 Problems for 3G/4G Network Connection.....	704
IX-7 Backing to Factory Default Setting If Necessary .....	705
IX-8 Contacting DrayTek .....	706
<b>Part X Telnet Commands.....</b>	<b>707</b>
Accessing Telnet of Vigor2927 .....	708

# Part I Installation



Installation

This part will introduce Vigor router and guide to install the device in hardware and software.



---

## I-1 Introduction

**This is a generic International version of the user guide. Specification, compatibility and features vary by region. For specific user guides suitable for your region or product, please contact local distributor.**

Vigor2927 series integrates IP layer QoS, NAT session/bandwidth management to help users control works well with large bandwidth.

By adopting hardware-based VPN platform and hardware encryption of AES/DES/3DES, the router increases the performance of VPN greatly, and offers several protocols (such as IPsec/PPTP/L2TP) with VPN tunnels.

The object-based design used in SPI (Stateful Packet Inspection) firewall allows users to set firewall policy with ease. CSM (Content Security Management) provides users control and management in IM (Instant Messenger) and P2P (Peer to Peer) more efficiency than before. By the way, DoS/DDoS prevention and URL/Web content filter strengthen the security outside and control inside. Object-based firewall is flexible and allows your network be safe.

User Management implemented on your router firmware can allow you to prevent any computer from accessing your Internet connection without a username or password. You can also allocate time budgets to your employees within office network.

With the 4-port Gigabit switch on the LAN side provides extremely high speed connectivity for the highest speed local data transfer of any server or local PCs. The tagged VLANs (IEEE802.1Q) can mark data with a VLAN identifier. This identifier can be carried through an onward Ethernet switch to specific ports. The specific VLAN clients can also pick up this identifier as it is just passed to the LAN. You can set the priorities for LAN-side QoS. You can assign each of VLANs to each of the different IP subnets that the router may also be operating, to provide even more isolation. The said functionality is tag-based Multi-subnet (Multiple-Private LAN Subnets).

On the Wireless-equipped models (e.g., Vigor2927lac) each of the wireless SSIDs can also be grouped within one of the VLANs.

In addition, Vigor2927 series supports USB interface for connecting USB printer to share printing function or 3G USB modem for network connection.

Vigor2927 series provides two-level management to simplify the configuration of network connection. The user mode allows user accessing into WEB interface via simple configuration. However, if users want to have advanced configurations, they can access into WEB interface through admin mode.

## I-1-1 Indicators and Connectors

Before you use the Vigor router, please get acquainted with the LED indicators and connectors first.

### I-1-1-1 Vigor2927



No.	LED	Status	Explanation
(1)	ACT	Off	The router is powered off.
		Blinking	The router is powered on and running normally.
	WAN2/WAN1	On	Internet connection is ready.
		Off	Internet connection is not ready.
		Blinking	The data is transmitting.
	USB1/USB2	On	USB device is connected and ready for use.
		Off	No USB device is connected.
		Blinking	The data is transmitting.
	DMZ	On	The DMZ function is enabled.
		Off	The DMZ function is disabled.
		Blinking	The data is transmitting.
	QoS	On	The QoS function is active.
		Off	The QoS function is inactive.
	VPN	On	The VPN tunnel is active.
		Off	VPN services are disabled
Blinking		Traffic is passing through VPN tunnel.	
WCF	On	The Web Content Filter is active. (It is enabled from Firewall >> General Setup).	
	Off	WCF is disabled.	
(2)	WAN1, WAN2 / P6		
	Left LED	On	The port is connected.
		Off	The port is disconnected.
		Blinking	The data is transmitting.
	Right LED	On	The port is connected with 1000Mbps.
		Off	The port is connected with 10/100Mbps.
	LAN P1-P5		
	Left LED	On	The port is connected.
		Off	The port is disconnected.
		Blinking	The data is transmitting.
	Right LED	On	The port is connected with 1000Mbps.
		Off	The port is connected with 10/100Mbps





No.	Interface	Description
(3)	Factory Reset	Restore the default settings. Usage: Turn on the router (ACT LED is blinking). Press the hole and keep for more than 5 seconds. When you see the ACT LED begins to blink rapidly than usual, release the button. Then the router will restart with the factory default configuration.
(4)	USB	Connector for a USB device (for 3G/4G USB Modem or printer or thermometer).
(5)	WAN1	Connector for a modem for accessing Internet.
	WAN2 / P6	Connector for local network devices or modem for accessing Internet. It is a switchable port. It can be used for LAN connection or WAN connection according to the settings configured in WUI.
	LAN P1-P5	Connectors for local network devices.
(6)	PWR	Connector for a power adapter.
	ON/OFF	Power Switch.

## I-1-1-2 Vigor2927L

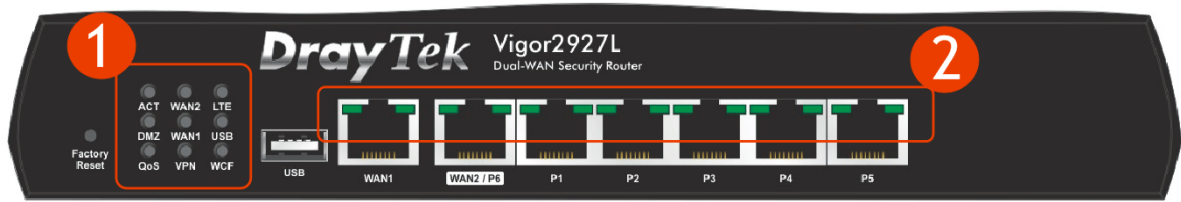

No.	LED	Status	Explanation
(1)	ACT	Off	The router is powered off.
		Blinking	The router is powered on and running normally.
	WAN2/WAN1	On	Internet connection is ready.
		Off	Internet connection is not ready.
		Blinking	The data is transmitting.
	LTE	On	LTE device is connected and ready for use.
		Off	LTE device is not detected, or has serious problem (e.g., no SIM card, SIM pin error, SIM deactivated, and etc.).
		Blinking	Slowly: LTE device is in dialing up. Quickly: The data is transmitting.
	DMZ	On	The DMZ function is enabled.
		Off	The DMZ function is disabled.
		Blinking	The data is transmitting.
	USB	On	USB device is connected and ready for use.
		Off	No USB device is connected.
		Blinking	The data is transmitting.
	QoS	On	The QoS function is active.
Off		The QoS function is inactive.	
VPN	On	The VPN tunnel is active.	
	Off	VPN services are disabled	
	Blinking	Traffic is passing through VPN tunnel.	
WCF	On	The Web Content Filter is active. (It is enabled from Firewall >> General Setup).	
	Off	WCF is disabled.	
(2)	WAN1,WAN2 / P6		
	Left LED	On	The port is connected.
		Off	The port is disconnected.
		Blinking	The data is transmitting.
	Right LED	On	The port is connected with 1000Mbps.
		Off	The port is connected with 10/100Mbps.
	LAN P1-P5		
	Left LED	On	The port is connected.
		Off	The port is disconnected.
		Blinking	The data is transmitting.
	Right LED	On	The port is connected with 1000Mbps.
		Off	The port is connected with 10/100Mbps



No.	Interface	Description
(3)	Factory Reset	Restore the default settings. Usage: Turn on the router (ACT LED is blinking). Press the hole and keep for more than 5 seconds. When you see the ACT LED begins to blink rapidly than usual, release the button. Then the router will restart with the factory default configuration.
(4)	USB	Connector for a USB device (for 3G/4G USB Modem or printer or thermometer).
(5)	WAN1	Connector for a modem for accessing Internet.
	WAN2 / P6	Connector for local network devices or modem for accessing Internet. It is a switchable port. It can be used for LAN connection or WAN connection according to the settings configured in WUI.
	LAN P1-P5	Connectors for local network devices.
(6)	PWR	Connector for a power adapter.
	ON/OFF	Power Switch.
(7)		Connector for installing LTE antennas.
(8)	SIM 2 / 1	Slots for installing SIM card.

### I-1-1-3 Vigor2927ac / Vigor2927ax / Vigor2927Lac

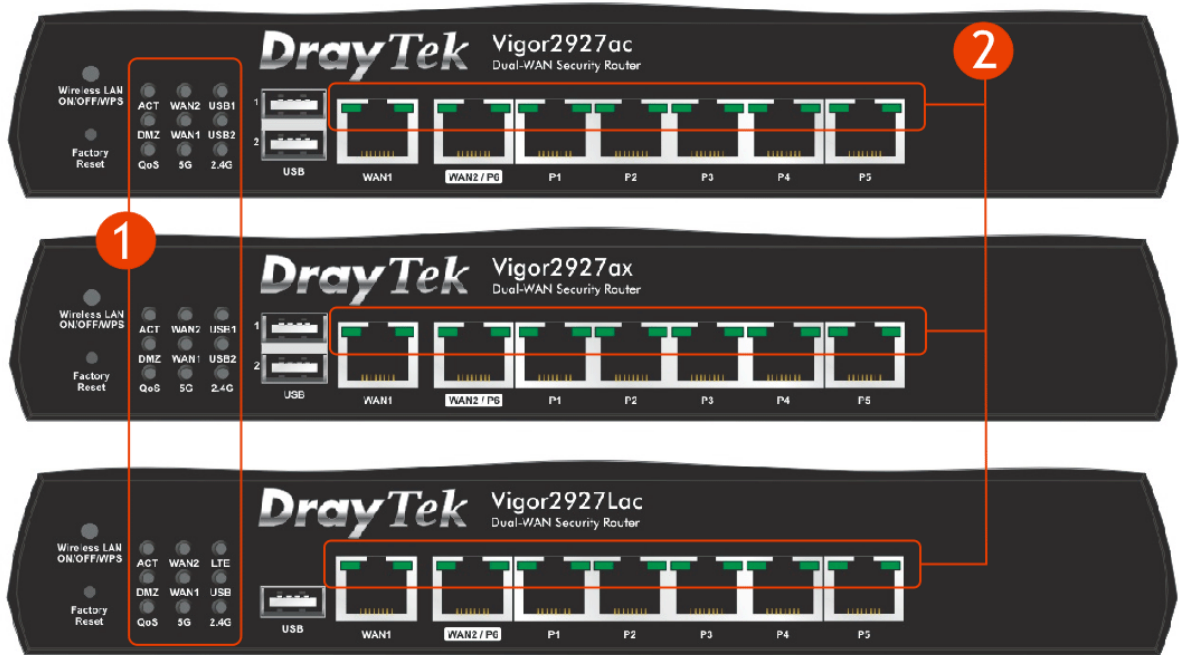

No.	LED	Status	Explanation
(1)	ACT	Off	The router is powered off.
		Blinking	The router is powered on and running normally.
	WAN2/WAN1	On	Internet connection is ready.
		Off	Internet connection is not ready.
		Blinking	The data is transmitting.
	USB1/USB2	On	USB device is connected and ready for use.
		Off	No USB device is connected.
		Blinking	The data is transmitting.
	LTE	On	LTE device is connected and ready for use.
		Off	LTE device is not detected, or has serious problem (e.g., no SIM card, SIM pin error, SIM deactivated, and etc.).
		Blinking	Slowly: LTE device is in dialing up. Quickly: The data is transmitting.
	DMZ	On	The DMZ function is enabled.
Off		The DMZ function is disabled.	
Blinking		The data is transmitting.	

(1)	QoS	On	The QoS function is active.
		Off	The QoS function is inactive.
	5G / 2.4G	On	5G / 2.4G: Wireless access point with bandwidth of 5GHz/2.4GHz is ready. WLAN: Wireless access point is ready.
		Off	Wireless function is disabled.
		Blinking	It will blink slowly while wireless traffic goes through. ACT and WLAN LEDs blink quickly and simultaneously when WPS is working, and will return to normal condition after two minutes. (You need to setup WPS within 2 minutes.)
(2)	WAN1,WAN2 / P6		
	Left LED	On	The port is connected.
		Off	The port is disconnected.
		Blinking	The data is transmitting.
	Right LED	On	The port is connected with 1000Mbps.
		Off	The port is connected with 10/100Mbps.
	LAN P1-P5		
	Left LED	On	The port is connected.
		Off	The port is disconnected.
		Blinking	The data is transmitting.
	Right LED	On	The port is connected with 1000Mbps.
		Off	The port is connected with 10/100Mbps

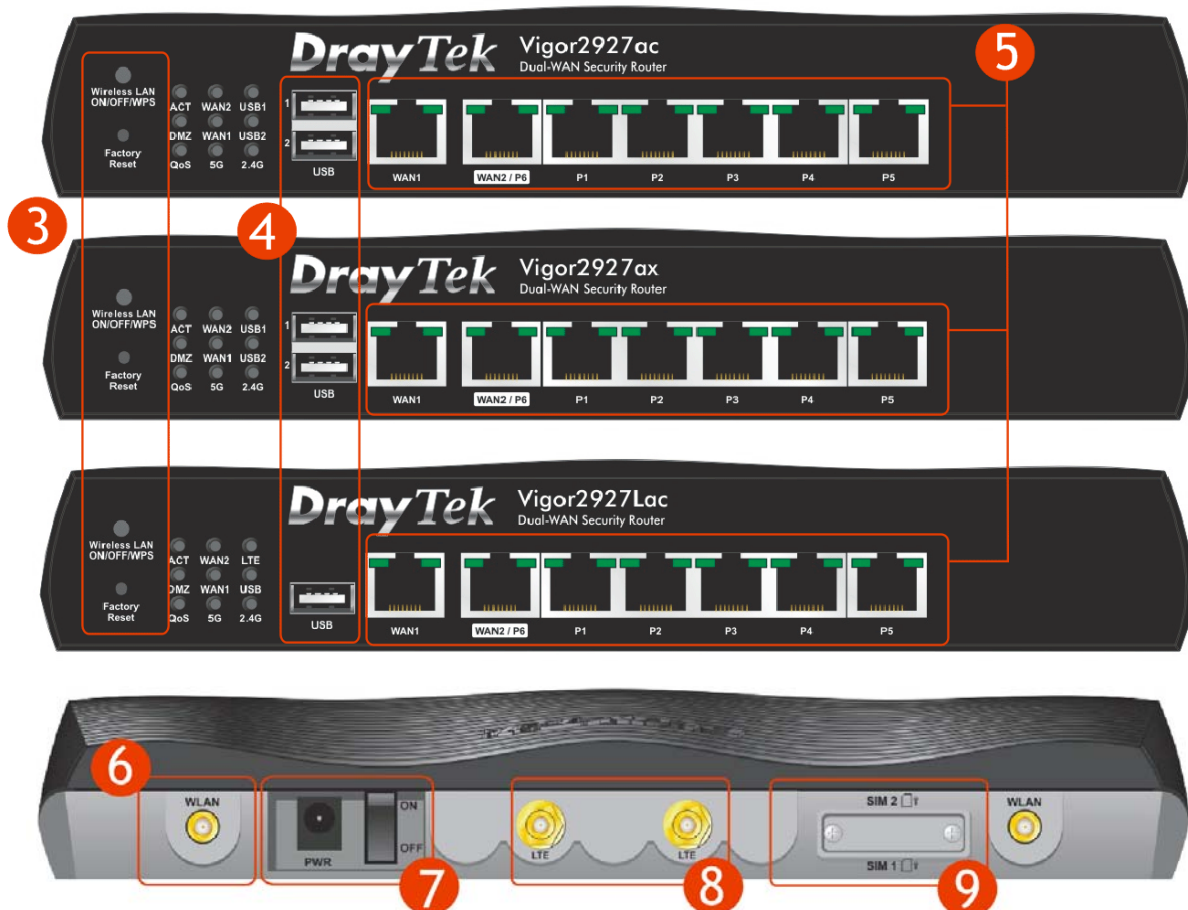

No.	Interface	Description
(3)	Wireless LAN ON/OFF/WPS	Wireless band will be switched /changed according to the button pressed and released. For example, <ul style="list-style-type: none"> <li>● 2.4G (On) and 5G (On) - in default.</li> <li>● 2.4G (Off) and 5G (On) - pressed and released the button once.</li> <li>● 2.4G (On) and 5G (Off) - pressed and released the button twice.</li> <li>● 2.4G (Off) and 5G (Off) - pressed and released the button three times.</li> </ul> When WPS function is enabled by web user interface, press this button for more than 2 seconds to wait for client's device making network connection through WPS.
	Factory Reset	Restore the default settings. Usage: Turn on the router (ACT LED is blinking). Press the hole and keep for more than 5 seconds. When you see the ACT LED begins to blink rapidly than usual, release the button. Then the router will restart with the factory default configuration.
(4)	USB1~2 / USB	Connector for a USB device (for 3G/4G USB Modem or printer or thermometer).
(5)	WAN1	Connector for a modem for accessing Internet.
	WAN2 / P6	Connector for local network devices or modem for accessing Internet. It is a switchable port. It can be used for LAN connection or WAN connection according to the settings configured in WUI.
	LAN P1-P5	Connectors for local network devices.
(6)	WLAN	Connector for installing WLAN antennas. (For ac model)
(7)	PWR	Connector for a power adapter.

	ON/OFF	Power Switch.
(8)		Connector for installing LTE antennas. (For L model).
(9)	SIM 2/1	Slots for installing SIM card. (For L model).

### I-1-1-4 Vigor2927Vac

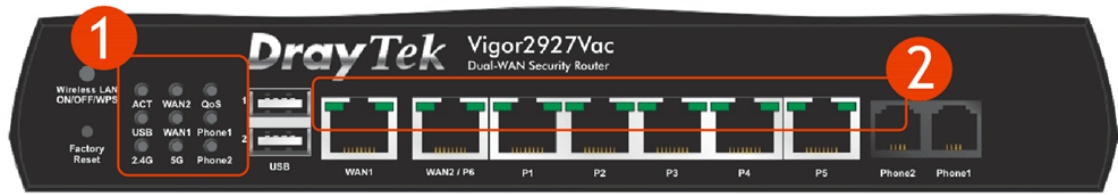

No.	LED	Status	Explanation
(1)	ACT	Off	The router is powered off.
		Blinking	The router is powered on and running normally.
	WAN2/WAN1	On	Internet connection is ready.
		Off	Internet connection is not ready.
		Blinking	The data is transmitting.
	QoS	On	The QoS function is active.
		Off	The QoS function is inactive.
	USB	On	USB device is connected and ready for use.
		Off	No USB device is connected.
		Blinking	The data is transmitting.
	Phone1/Phone 2	On	The phone connected to this port is off-hook.
Off		The phone connected to this port is on-hook.	
Blinking		A phone call comes.	
2.4G/5G	On	5G / 2.4G: Wireless access point with bandwidth of 5GHz/2.4GHz is ready. WLAN: Wireless access point is ready.	
	Off	Wireless function is disabled.	
	Blinking	It will blink slowly while wireless traffic goes through. ACT and WLAN LEDs blink quickly and simultaneously when WPS is working, and will return to normal condition after two minutes. (You need to setup WPS within 2 minutes.)	
(2)	WAN1, WAN2 / P6		
	Left LED	On	The port is connected.
		Off	The port is disconnected.
		Blinking	The data is transmitting.
	Right LED	On	The port is connected with 1000Mbps.
		Off	The port is connected with 10/100Mbps.
	LAN P1-P5		
	Left LED	On	The port is connected.
		Off	The port is disconnected.
		Blinking	The data is transmitting.
	Right LED	On	The port is connected with 1000Mbps.
Off		The port is connected with 10/100Mbps	





No.	Interface	Description
(3)	Wireless LAN ON/OFF/WPS	<p>Wireless band will be switched /changed according to the button pressed and released. For example,</p> <ul style="list-style-type: none"> <li>● 2.4G (On) and 5G (On) - in default.</li> <li>● 2.4G (Off) and 5G (On) - pressed and released the button once.</li> <li>● 2.4G (On) and 5G (Off) - pressed and released the button twice.</li> <li>● 2.4G (Off) and 5G (Off) - pressed and released the button three times.</li> </ul> <p>When WPS function is enabled by web user interface, press this button for more than 2 seconds to wait for client's device making network connection through WPS.</p>
	Factory Reset	Restore the default settings. Usage: Turn on the router (ACT LED is blinking). Press the hole and keep for more than 5 seconds. When you see the ACT LED begins to blink rapidly than usual, release the button. Then the router will restart with the factory default configuration.
(4)	USB1-2 / USB	Connector for a USB device (for 3G/4G USB Modem or printer or thermometer).
(5)	WAN1	Connector for a modem for accessing Internet.
	WAN2 / P6	Connector for local network devices or modem for accessing Internet. It is a switchable port. It can be used for LAN connection or WAN connection according to the settings configured in WUI.
	LAN P1-P5	Connectors for local network devices.
(6)	 WLAN	Connector for installing WLAN antennas. (For ac model)
(7)	PWR	Connector for a power adapter.
	ON/OFF	Power Switch.

---

## I-1-2 Notes for Antenna Installation (for "L" model)

Magnetic antenna must be installed on the extension base before connecting to Vigor router.

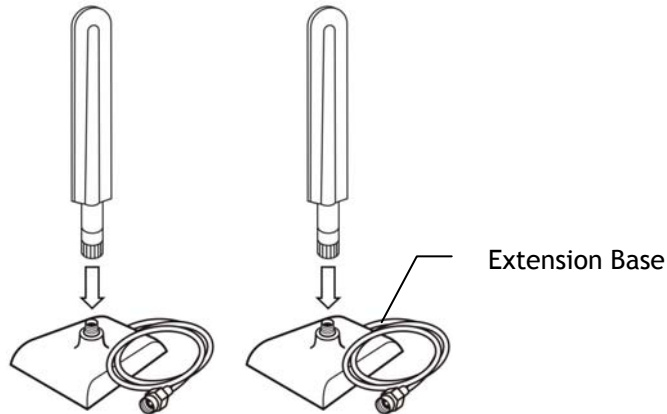

There are two mounting holes for installing antennas with extension base on Vigor router. Please install them as shown below.



Note, if only one antenna shall be installed, please use the mounting hole (major signal transmitted hole) near to the power switch.

While installing the SIM card into the card slot, note that back plate of the SIM card slot must be removed first and the direction of card notch must be on the left side.



There are two types of antennas provided for Vigor2927Lac, which must be installed in different locations carefully and correctly. Wrong installation might cause bad signal of wireless connection. Therefore, pay attention to the installation of antennas by referring to the following illustration.

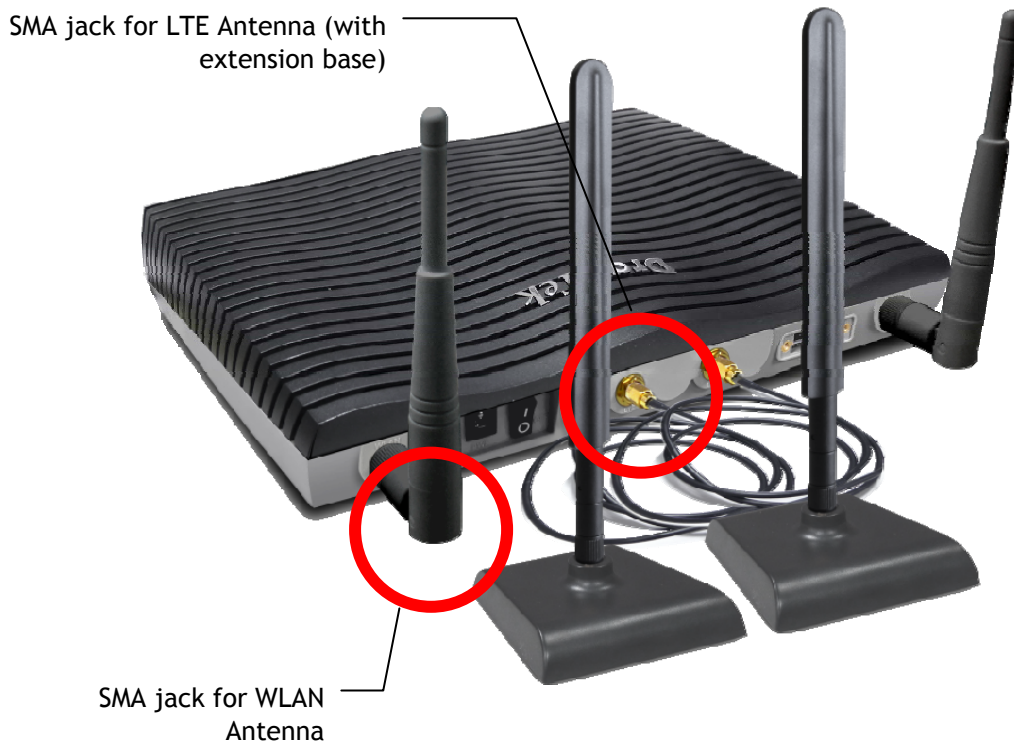

---

## I-2 Hardware Installation

---

### I-2-1 Installing Vigor Router

Before starting to configure the router, you have to connect your devices correctly. (For the hardware connection, we take "ac" model as an example.)

1. Connect the DSL interface to the land line jack with a DSL line cable.  
Connect the cable Modem/DSL Modem/Media Converter to the WAN port of router with Ethernet cable (RJ-45).
2. Connect one end of an Ethernet cable (RJ-45) to one of the LAN ports of the router and the other end of the cable (RJ-45) into the Ethernet port on your computer.
3. Connect one end of the power adapter to the router's power port on the rear panel, and the other side into a wall outlet.
4. Power on the device by pressing down the power switch on the rear panel.
5. The system starts to initiate. After completing the system test, the ACT LED will light up and start blinking.

(For the hardware connection, we take "ac" model as an example.)

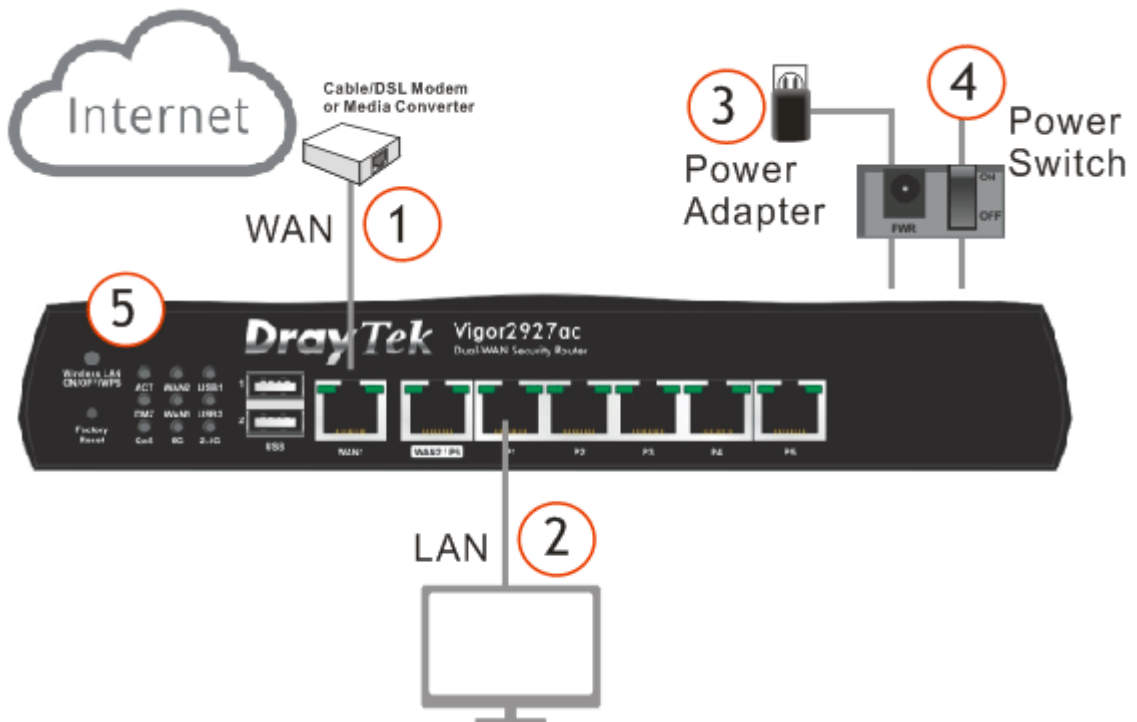

---

## I-2-2 Wall-Mounted Installation

Vigor router has keyhole type mounting slots on the underside.

1. Drill two holes on the wall. The distance between the holes shall be 168mm.
2. Fit screws into the wall using the appropriate type of wall plug.

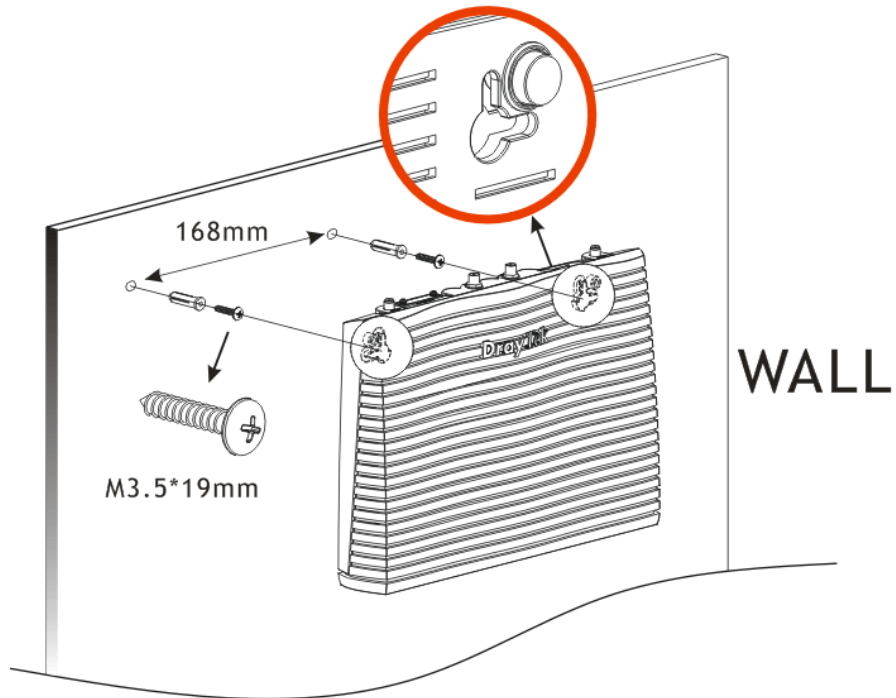

Info

The recommended drill diameter shall be 6.5mm (1/4").

---

3. When you finished about procedure, the router has been mounted on the wall firmly.

## I-2-3 Installing USB Printer to Vigor Router

You can install a printer onto the router for sharing printing. All the PCs connected this router can print documents via the router. The example provided here is made based on Windows 7. For other Windows system, please visit [www.DrayTek.com](http://www.DrayTek.com).

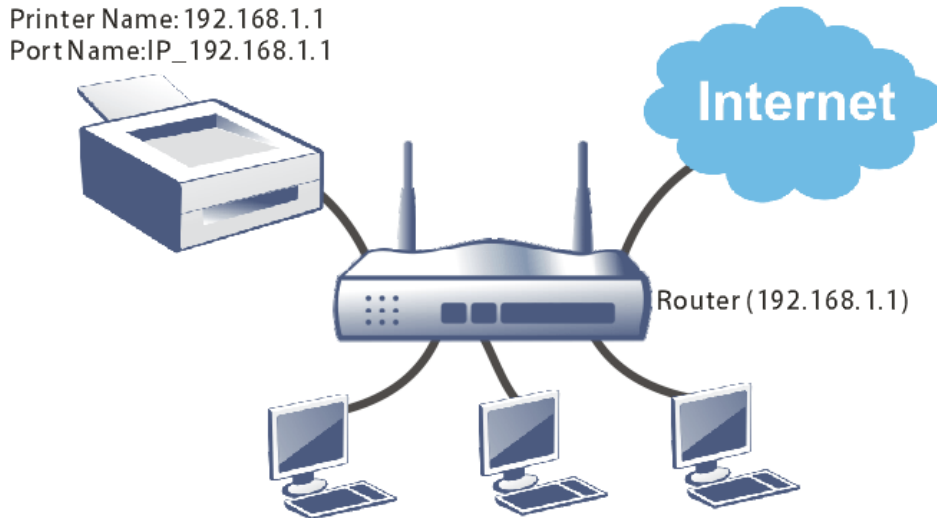

Before using it, please follow the steps below to configure settings for connected computers (or wireless clients).

1. Connect the printer with the router through USB/parallel port.
2. Open All Programs>>Getting Started>>Devices and Printers.

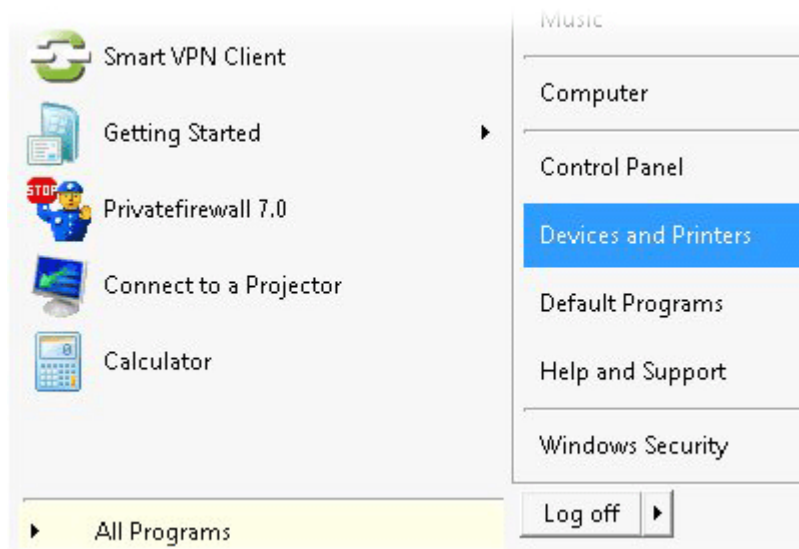

3. Click Add a printer.

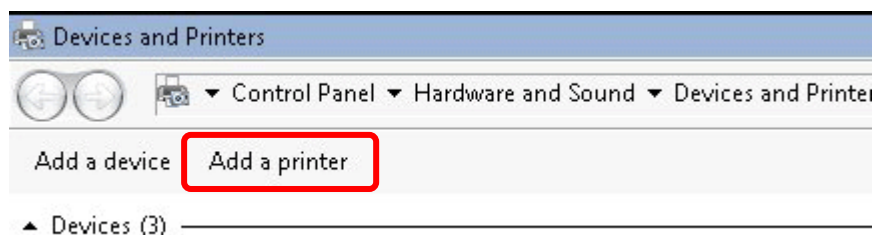

4. A dialog will appear. Click Add a local printer and click Next.

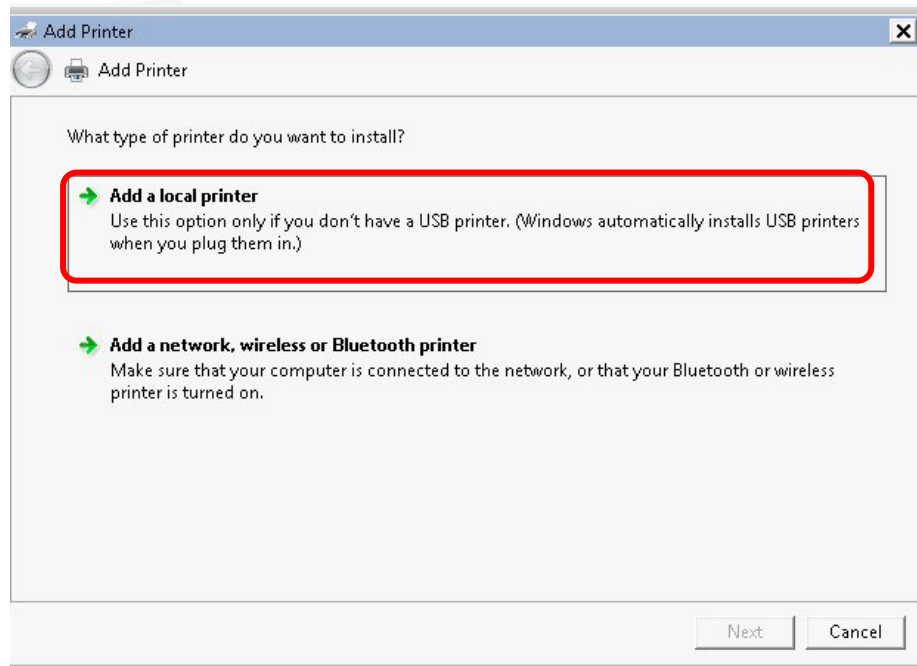

5. In this dialog, choose Create a new port. In the field of Type of port, use the drop down list to select Standard TCP/IP Port. Then, click Next.

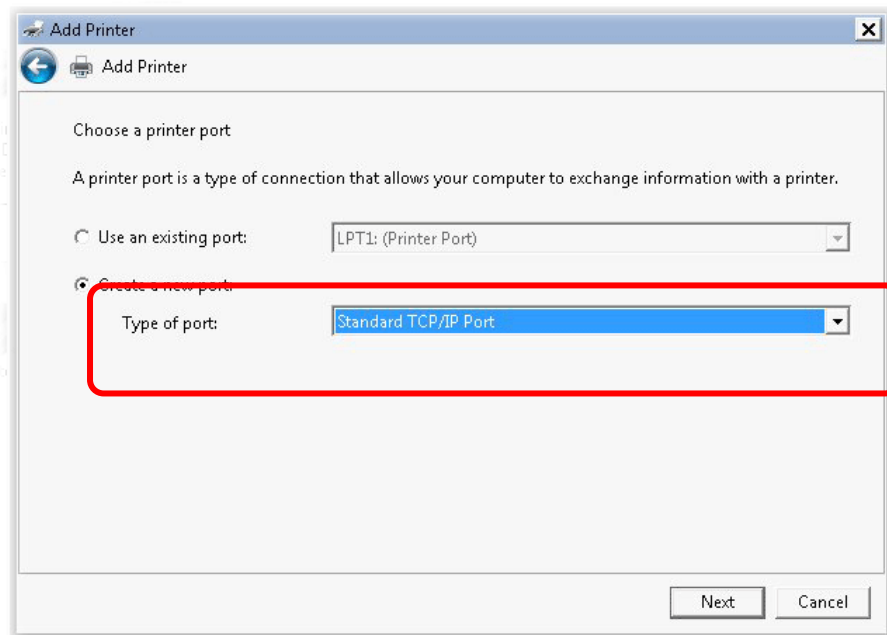

6. In the following dialog, type 192.168.1.1 (router's LAN IP) in the field of Hostname or IP Address and type 192.168.1.1 as the Port name. Then, click Next.

The screenshot shows the 'Add Printer' dialog box with the following fields and options:

- Device type: TCP/IP Device
- Hostname or IP address: 192.168.1.1
- Port name: 192.168.1.1
- Query the printer and automatically select the driver to use

Buttons: Next, Cancel

7. Click Standard and choose Generic Network Card.

The screenshot shows the 'Add Printer' dialog box with the following content:

Additional port information required

The device is not found on the network. Be sure that:

1. The device is turned on.
2. The network is connected.
3. The device is properly configured.
4. The address on the previous page is correct.

If you think the address is not correct, click Back to return to the previous page. Then correct the address and perform another search on the network. If you are sure the address is correct, select the device type below.

Device Type

- Standard: Generic Network Card
- Custom: Settings...

Buttons: Next, Cancel



- Now, your system will ask you to choose right name of the printer that you installed onto the router. Such step can make correct driver loaded onto your PC. When you finish the selection, click Next.

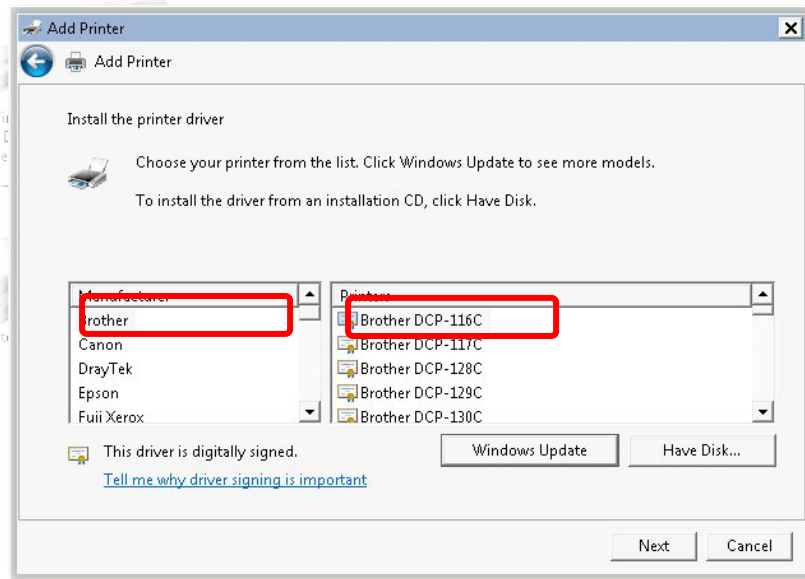

- Type a name for the chosen printer. Click Next.

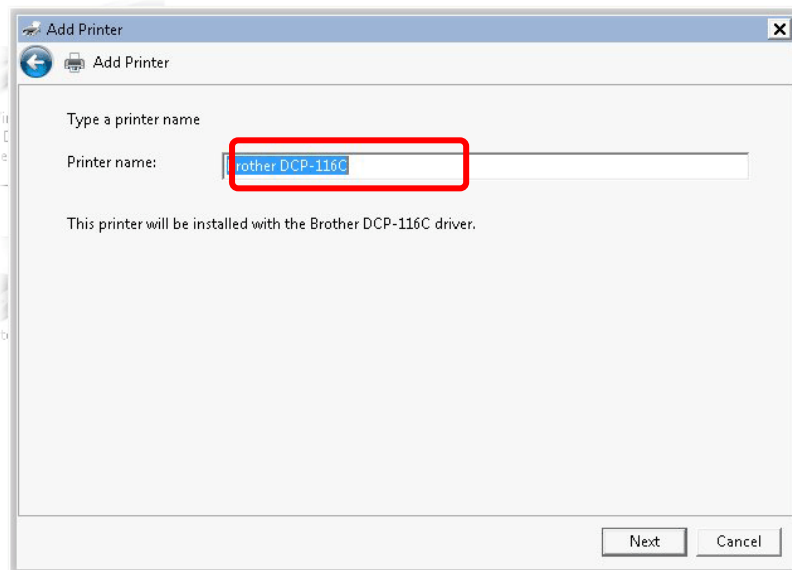

10. Choose Do not share this printer and click Next.

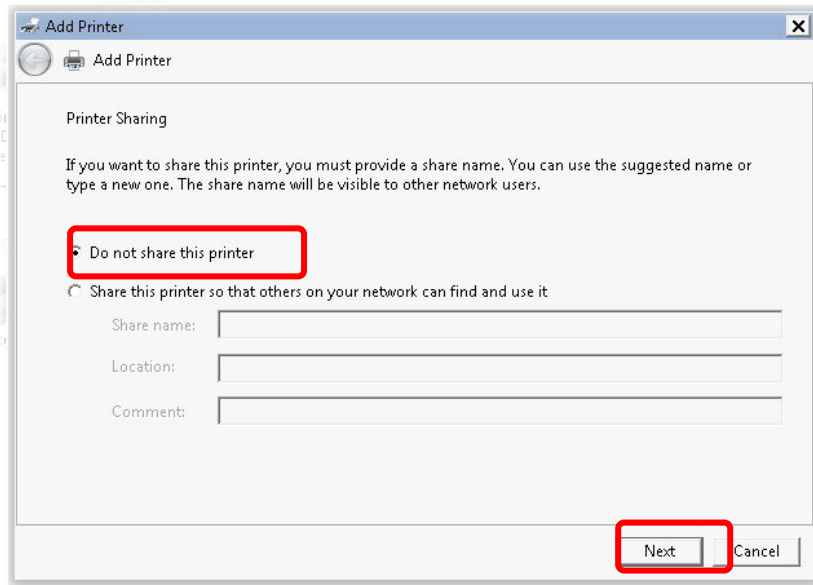

11. Then, in the following dialog, click Finish.

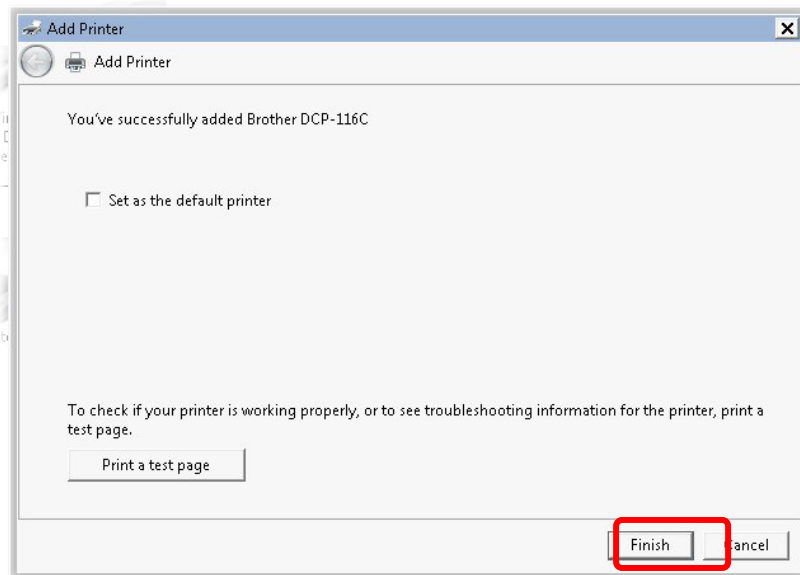

12. The new printer has been added and displayed under Printers and Faxes. Click the new printer icon and click Printer server properties.

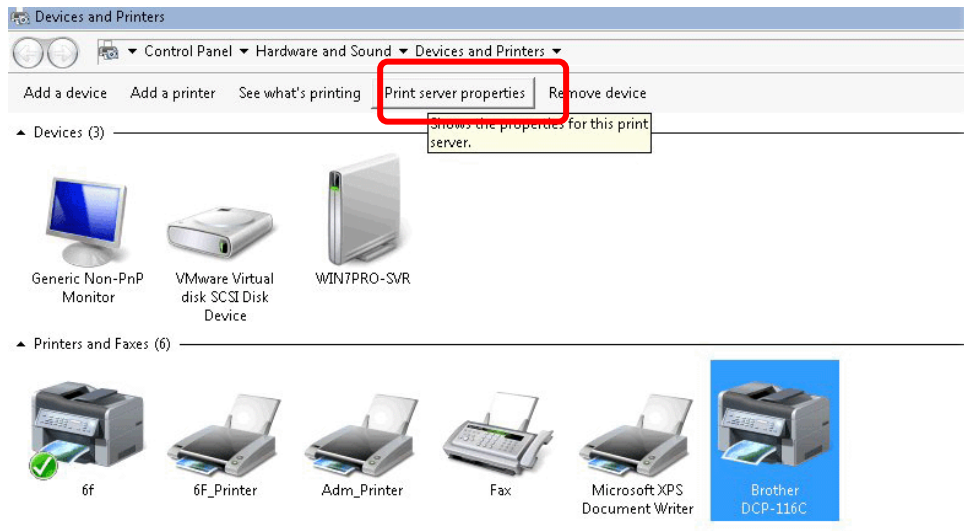

13. Edit the property of the new printer you have added by clicking Configure Port.

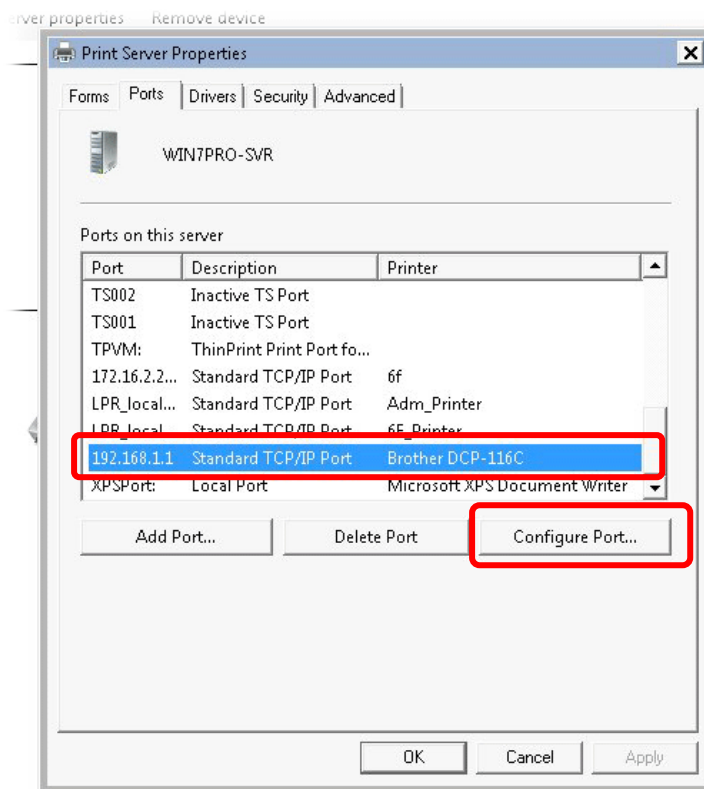

14. Select "LPR" on Protocol, type p1 (number 1) as Queue Name. Then click OK. Next please refer to the red rectangle for choosing the correct protocol and LPR name.

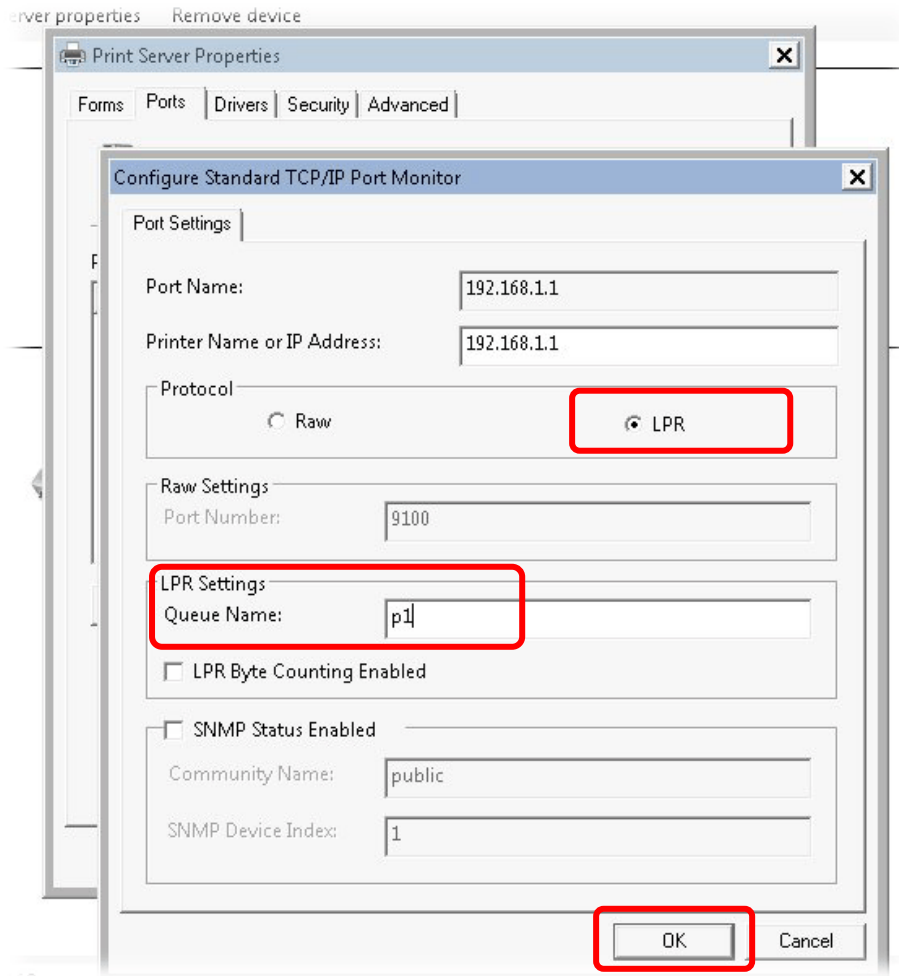

The printer can be used for printing now. Most of the printers with different manufacturers are compatible with vigor router.



**Info**

Some printers with the fax/scanning or other additional functions are not supported.

Vigor router supports printing request from computers via LAN ports but not WAN port.

---

## I-3 Accessing Web Page

1. Make sure your PC connects to the router correctly.

You may either simply set up your computer to get IP dynamically from the router or set up the IP address of the computer to be the same subnet as the default IP address of Vigor router 192.168.1.1. For the detailed information, please refer to the later section - Trouble Shooting of the guide.

2. Open a web browser on your PC and type <http://192.168.1.1>. The following window will be open to ask for username and password.



**DrayTek** **Vigor2927 Series**

**Login**

**Username**

**Password**

**Language**  ▼

**Login**

**Security Warning: You are logging in without encryption which is not recommended. To login securely [click here](#).**

Copyright© 2000-2022 DrayTek Corp. All Rights Reserved.

3. Please type “admin/admin” as the Username/Password and click Login.



---

### Info

If you fail to access to the web configuration, please go to “Trouble Shooting” for detecting and solving your problem.

---

- Now, the Main Screen will appear. Take Vigor2927ac as an example.

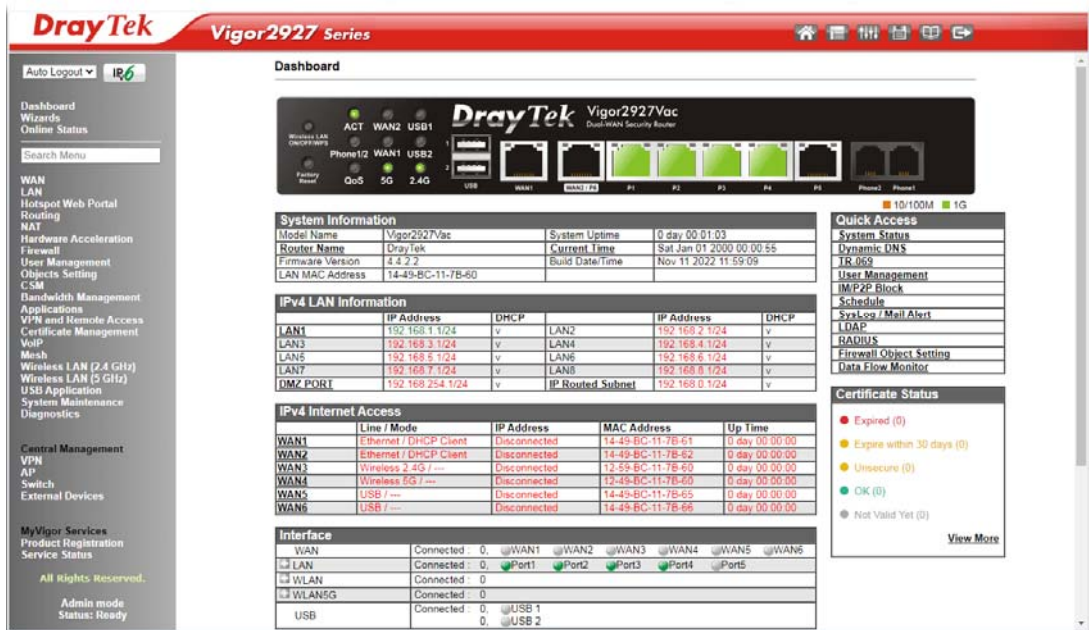

#### Info

The home page will be different slightly in accordance with the type of the router you have.

- The web page can be logged out according to the chosen condition. The default setting is Auto Logout, which means the web configuration system will logout after 5 minutes without any operation. Change the setting for your necessity.

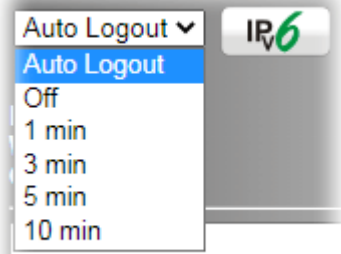

---

## I-4 Changing Password

Please change the password for the original security of the router.

1. Open a web browser on your PC and type <http://192.168.1.1>. A pop-up window will open to ask for username and password.
2. Please type “admin/admin” as Username/Password for accessing into the web user interface with admin mode.
3. Go to System Maintenance page and choose Administrator Password.

System Maintenance >> Administrator Password Setup

### Administrator Password

Old Password	<input type="text"/>	Max: 83 characters
New Password	<input type="text"/>	Max: 83 characters
Confirm Password	<input type="text"/>	Max: 83 characters
Password Strength:	<input type="button" value="Weak"/> <input type="button" value="Medium"/> <input type="button" value="Strong"/>	
Strong password requirements:		
1. Have at least one upper-case letter and one lower-case letter.		
2. Including non-alphanumeric characters is a plus.		
<input checked="" type="checkbox"/>	Enable 'admin' account login to Web UI from the Internet	
<input type="checkbox"/>	Enable Advanced Authentication method when login from "WAN"	
<input type="radio"/>	Time-based One-time Password (TOTP)	
<input checked="" type="radio"/>	Mobile one-Time Passwords(mOTP)	
PIN Code	<input type="text"/>	Secret <input type="text"/>

4. Enter the login password (the default is “admin”) on the field of Old Password. Type New Password and Confirm Password. Then click OK to continue.



Info

The maximum length of the password you can set is 23 characters.

5. Now, the password has been changed. Next time, use the new password to access the Web user interface for this router.



The image shows the login page for a DrayTek Vigor2927 Series router. The page has a red header with the DrayTek logo and 'Vigor2927 Series'. Below the header is a 'Login' section with three input fields: 'Username' (containing 'admin'), 'Password' (containing six dots), and 'Language' (a dropdown menu set to 'English'). A 'Login' button is located below the fields. At the bottom of the login section, there is a 'Security Warning' message: 'Security Warning: You are logging in without encryption which is not recommended. To login securely [click here](#).' Below the warning is the copyright notice: 'Copyright© 2000-2022 DrayTek Corp. All Rights Reserved.'



Info

Even the password is changed, the Username for logging onto the web user interface is still “admin”.

## I-5 Dashboard

Dashboard shows the connection status including System Information, IPv4 Internet Access, IPv6 Internet Access, Interface (physical connection), Security and Quick Access.

Click Dashboard from the main menu on the left side of the main page.

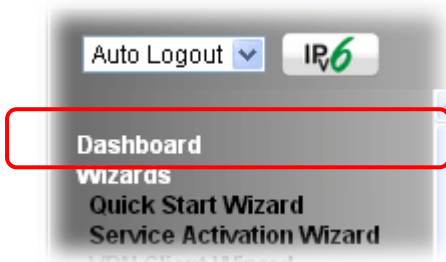

A web page with default selections will be displayed on the screen. Refer to the following figure:

Dashboard

The dashboard displays the router's status and configuration. At the top, there's a hardware status bar with indicators for ACT, WAN2, USB1, Phone1/2, WAN1, USB2, QoS, 5G, 2.4G, and various ports (WAN1, WAN2/P0, P1-P5, Phone2, Phone1). Below this are several data tables and a quick access menu.

System Information			
Model Name	Vigor2927Vac	System Uptime	0 day 00:01:03
Router Name	DrayTek	Current Time	Sat Jan 01 2000 00:00:55
Firmware Version	4.4.2.2	Build Date/Time	Nov 11 2022 11:59:09
LAN MAC Address	14-49-BC-11-7B-60		

IPv4 LAN Information					
LAN	IP Address	DHCP	LAN	IP Address	DHCP
LAN1	192.168.1.1/24	v	LAN2	192.168.2.1/24	v
LAN3	192.168.3.1/24	v	LAN4	192.168.4.1/24	v
LAN5	192.168.5.1/24	v	LAN6	192.168.6.1/24	v
LAN7	192.168.7.1/24	v	LAN8	192.168.8.1/24	v
DMZ PORT	192.168.254.1/24	v	IP Routed Subnet	192.168.0.1/24	v

IPv4 Internet Access				
WAN	Line / Mode	IP Address	MAC Address	Up Time
WAN1	Ethernet / DHCP Client	Disconnected	14-49-BC-11-7B-61	0 day 00:00:00
WAN2	Ethernet / DHCP Client	Disconnected	14-49-BC-11-7B-62	0 day 00:00:00
WAN3	Wireless 2.4G / ---	Disconnected	12-59-BC-11-7B-60	0 day 00:00:00
WAN4	Wireless 5G / ---	Disconnected	12-49-BC-11-7B-60	0 day 00:00:00
WAN5	USB / ---	Disconnected	14-49-BC-11-7B-65	0 day 00:00:00
WAN6	USB / ---	Disconnected	14-49-BC-11-7B-66	0 day 00:00:00

Interface	
WAN	Connected : 0, WAN1 WAN2 WAN3 WAN4 WAN5 WAN6
LAN	Connected : 0, Port1 Port2 Port3 Port4 Port5
WLAN	Connected : 0
WLAN5G	Connected : 0
USB	Connected : 0, USB 1, USB 2

**Quick Access**

- System Status
- Dynamic DNS
- TR-069
- User Management
- IM/P2P Block
- Schedule
- SysLog / Mail Alert
- LDAP
- RADIUS
- Firewall Object Setting
- Data Flow Monitor

**Certificate Status**

- Expired (0)
- Expire within 30 days (0)
- Unsecure (0)
- OK (0)
- Not Valid Yet (0)

[View More](#)



## I-5-1 Virtual Panel

On the top of the Dashboard, a virtual panel (simulating the physical panel of the router) displays the physical interface connection. It will be refreshed every five seconds. When you move and click the mouse cursor on LEDs (except ACT), USB ports, WAN2/P6, or LAN1 - LAN5 (P1-P5), related web setting page will be open for you to configure if required.



Port	Color	Description
WAN2/P6	Black	WAN2 port is disconnected.
	Green	WAN2 port is connected at 1 Gbps.
	Orange	WAN2 port is connected at 10/100 Mbps.
P1 ~ P5	Black	LAN port is disconnected.
	Green	LAN port is connected at 1 Gbps.
	Orange	LAN port is connected at 10/100 Mbps.

For detailed information about the LED display, refer to I-1-1 LED Indicators and Connectors.

---

## I-5-2 Name with a Link

A name with a link (e.g., Router Name, Current Time, WAN1~6 and etc.) below means you can click it to open the configuration page for modification.

System Information			
Model Name	Vigor2927Vac	System Uptime	0 day 00:01:03
<a href="#">Router Name</a>	DrayTek	<a href="#">Current Time</a>	Sat Jan 01 2000 00:00:55
Firmware Version	4.4.2.2	Build Date/Time	Nov 11 2022 11:59:09
LAN MAC Address	14-49-BC-11-7B-60		

IPv4 LAN Information					
	IP Address	DHCP		IP Address	DHCP
<a href="#">LAN1</a>	192.168.1.1/24	v	LAN2	192.168.2.1/24	v
LAN3	192.168.3.1/24	v	LAN4	192.168.4.1/24	v
LAN5	192.168.5.1/24	v	LAN6	192.168.6.1/24	v
LAN7	192.168.7.1/24	v	LAN8	192.168.8.1/24	v
DMZ PORT	192.168.254.1/24	v	IP Routed Subnet	192.168.0.1/24	v

IPv4 Internet Access				
	Line / Mode	IP Address	MAC Address	Up Time
<a href="#">WAN1</a>	Ethernet / DHCP Client	Disconnected	14-49-BC-11-7B-61	0 day 00:00:00
<a href="#">WAN2</a>	Ethernet / DHCP Client	Disconnected	14-49-BC-11-7B-62	0 day 00:00:00
<a href="#">WAN3</a>	Wireless 2.4G / ---	Disconnected	12-59-BC-11-7B-60	0 day 00:00:00
<a href="#">WAN4</a>	Wireless 5G / ---	Disconnected	12-49-BC-11-7B-60	0 day 00:00:00
<a href="#">WAN5</a>	USB / ---	Disconnected	14-49-BC-11-7B-65	0 day 00:00:00
<a href="#">WAN6</a>	USB / ---	Disconnected	14-49-BC-11-7B-66	0 day 00:00:00

---

## I-5-3 Status for LTE

It is a short table which displays current status for Vigor2927L/Vigor2927Lac including access mode used, access tech adopted, band usage, operator, strength of signal and notification of new SMS received.

LTE Status	
Status	
LTE access mode	[None]
Access Tech	
---	
Band	
---	
Operator	
---	
Signal	
---	dBm
New SMS	
---	

## I-5-4 Quick Access for Common Used Menu

All the menu items can be accessed and arranged orderly on the left side of the main page for your request. However, some important and common used menu items which can be accessed in a quick way just for convenience.

Look at the right side of the Dashboard. You will find a group of common used functions grouped under Quick Access.

Quick Access
<a href="#">System Status</a>
<a href="#">Dynamic DNS</a>
<a href="#">TR-069</a>
<a href="#">User Management</a>
<a href="#">IM/P2P Block</a>
<a href="#">Schedule</a>
<a href="#">SysLog / Mail Alert</a>
<a href="#">LDAP</a>
<a href="#">RADIUS</a>
<a href="#">Firewall Object Setting</a>
<a href="#">Data Flow Monitor</a>

The function links of System Status, Dynamic DDNS, TR-069, User Management, IM/P2P Block, Schedule, Syslog/Mail Alert, LDAP, RADIUS, Firewall Object Setting and Data Flow Monitor are displayed here. Move your mouse cursor on any one of the links and click on it. The corresponding setting page will be open immediately.

In addition, quick access for VPN security settings such as Remote Dial-in User and LAN to LAN are located on the bottom of this page. Scroll down the page to find them and use them if required.

IPv4 LAN Information					
	IP Address	DHCP		IP Address	DHCP
LAN1	192.168.1.1/24	v	LAN2	192.168.2.1/24	v
LAN3	192.168.3.1/24	v	LAN4	192.168.4.1/24	v
LAN5	192.168.5.1/24	v	LAN6	192.168.6.1/24	v
LAN7	192.168.7.1/24	v	LAN8	192.168.8.1/24	v
DMZ PORT	192.168.254.1/24	v	IP Routed Subnet	192.168.0.1/24	v

IPv4 Internet Access				
	Line / Mode	IP Address	MAC Address	Up Time
WAN1	Ethernet / DHCP Client	Disconnected	14-49-BC-11-7B-61	0 day 00:00:00
WAN2	Ethernet / DHCP Client	Disconnected	14-49-BC-11-7B-62	0 day 00:00:00
WAN3	Wireless 2.4G / ---	Disconnected	12-59-BC-11-7B-60	0 day 00:00:00
WAN4	Wireless 5G / ---	Disconnected	12-49-BC-11-7B-60	0 day 00:00:00
WAN5	USB / ---	Disconnected	14-49-BC-11-7B-65	0 day 00:00:00
WAN6	USB / ---	Disconnected	14-49-BC-11-7B-66	0 day 00:00:00

Interface	
WAN	Connected : 0, <input type="radio"/> WAN1 <input type="radio"/> WAN2 <input type="radio"/> WAN3 <input type="radio"/> WAN4 <input type="radio"/> WAN5 <input type="radio"/> WAN6
LAN	Connected : 0, <input checked="" type="radio"/> Port1 <input type="radio"/> Port2 <input type="radio"/> Port3 <input type="radio"/> Port4 <input type="radio"/> Port5
VLAN	Connected : 0
WLAN5G	Connected : 0
USB	Connected : 0, <input type="radio"/> USB 1 0, <input type="radio"/> USB 2

Security	
<input checked="" type="checkbox"/> VPN	Connected : 0 <span style="float: right;"><a href="#">Remote Dial-in User / LAN to LAN</a></span>
<input checked="" type="checkbox"/> MyVigor	Activate : 0
<input checked="" type="checkbox"/> DoS	Attack Detected :
<input checked="" type="checkbox"/> RootCA	

System Resource		
Current Status	CPU Usage: <div style="width: 1%;"></div>	1%
	Memory Usage: <div style="width: 81%;"></div>	81%

Note that there is a plus (+) icon located on the left side of VPN/LAN. Click it to review the VPN connection(s) used presently.

Interface	
WAN	Connected : 0, <input type="radio"/> WAN1 <input type="radio"/> WAN2 <input type="radio"/> WAN3 <input type="radio"/> WAN4 <input type="radio"/> WAN5 <input type="radio"/> WAN6
+ LAN	Connected : 0, <input checked="" type="radio"/> Port1 <input checked="" type="radio"/> Port2 <input checked="" type="radio"/> Port3 <input checked="" type="radio"/> Port4 <input type="radio"/> Port5
WLAN	Connected : 0
+ WLAN5G	Connected : 0
USB	Connected : 0, <input type="radio"/> USB 1 0, <input type="radio"/> USB 2

Host connected physically to the router via LAN port(s) will be displayed with green circles in the field of Connected.

All of the hosts (including wireless clients) displayed with Host ID, IP Address and MAC address indicates that the traffic would be transmitted through LAN port(s) and then the WAN port. The purpose is to perform the traffic monitor of the host(s).

## I-5-5 GUI Map



All the functions the router supports are listed with table clearly in this page. Users can click the function link to access into the setting page of the function for detailed configuration. Click the icon on the top of the main screen to display all the functions.

System Maintenance >> Administrator Password

<a href="#">Dashboard</a>		<b>VoIP</b>	<a href="#">General Settings</a>
<b>Wizards</b>	<a href="#">Quick Start Wizard</a> <a href="#">Service Activation Wizard</a> <a href="#">VPN Client Wizard</a> <a href="#">VPN Server Wizard</a> <a href="#">Wireless Wizard</a> <a href="#">Mesh Wizard</a> <a href="#">VoIP Wizard</a>	<b>Mesh</b>	<a href="#">Mesh Setup</a> <a href="#">Mesh Status</a> <a href="#">Mesh Discovery</a> <a href="#">Basic Config Sync</a> <a href="#">Advanced Config Sync</a> <a href="#">Support List</a>
<b>Online Status</b>	<a href="#">Physical Connection</a> <a href="#">Virtual WAN</a>	<b>Wireless LAN (2.4 GHz)</b>	<a href="#">General Setup</a> <a href="#">Security</a> <a href="#">Access Control</a> <a href="#">WPS</a> <a href="#">Advanced Setting</a> <a href="#">Station Control</a> <a href="#">Bandwidth Management</a> <a href="#">AP Discovery</a> <a href="#">Airtime Fairness</a> <a href="#">Band Steering</a> <a href="#">Roaming</a> <a href="#">Station List</a>
<b>WAN</b>	<a href="#">General Setup</a> <a href="#">Internet Access</a> <a href="#">Multi-VLAN</a> <a href="#">WAN Budget</a>	<b>Wireless LAN (5 GHz)</b>	<a href="#">General Setup</a> <a href="#">Security</a> <a href="#">Access Control</a> <a href="#">WPS</a> <a href="#">WDS</a> <a href="#">Advanced Setting</a> <a href="#">Station Control</a> <a href="#">Bandwidth Management</a>
<b>LAN</b>	<a href="#">General Setup</a> <a href="#">VLAN</a> <a href="#">Bind IP to MAC</a> <a href="#">LAN Port Mirror</a> <a href="#">Wired 802.1X</a> <a href="#">Link Aggregation</a>		
<b>Hotspot Web Portal</b>	<a href="#">Profile Setup</a> <a href="#">Users Information</a> <a href="#">Quota Management</a> <a href="#">PIN Generator</a>		
<b>Routing</b>	<a href="#">Static Route</a>		

## I-5-6 Web Console



It is not necessary to use the telnet command via DOS prompt. The changes made by using web console have the same effects as modified through web user interface. The functions/settings modified under Web Console also can be reviewed on the web user interface.

Click the Web Console icon on the top of the main screen to open the following screen.

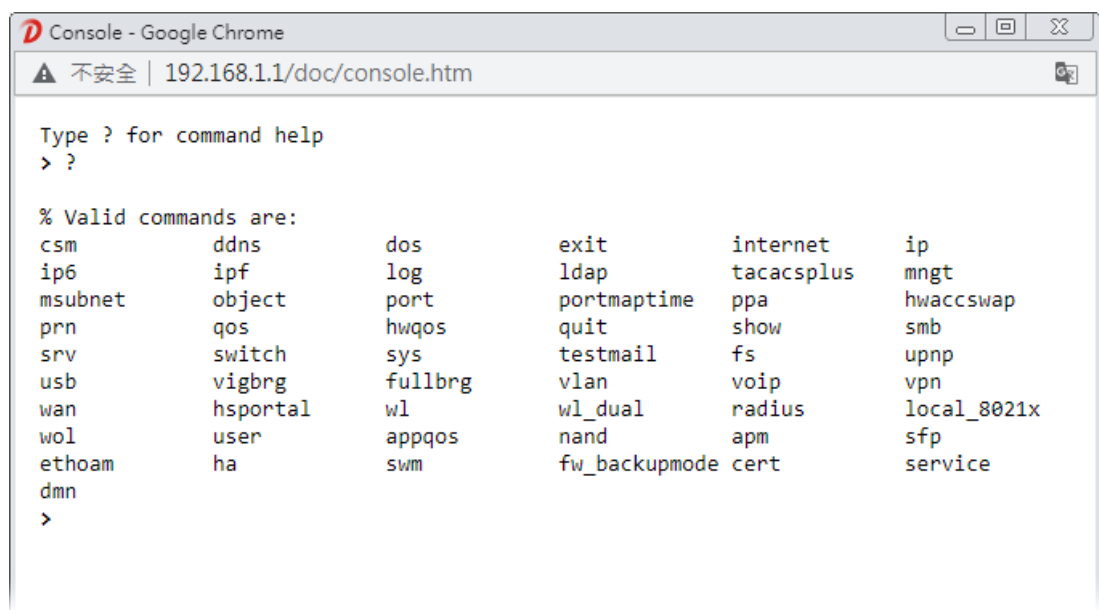

---

## I-5-7 Config Backup



There is one way to store current used settings quickly by clicking the Config Backup icon. It allows you to backup current settings as a file. Such configuration file can be restored by using System Maintenance>>Configuration Backup.

---

## I-5-8 Manual Download



Click this icon to open online user's guide of Vigor router. This document offers detailed information for the settings on web user interface.

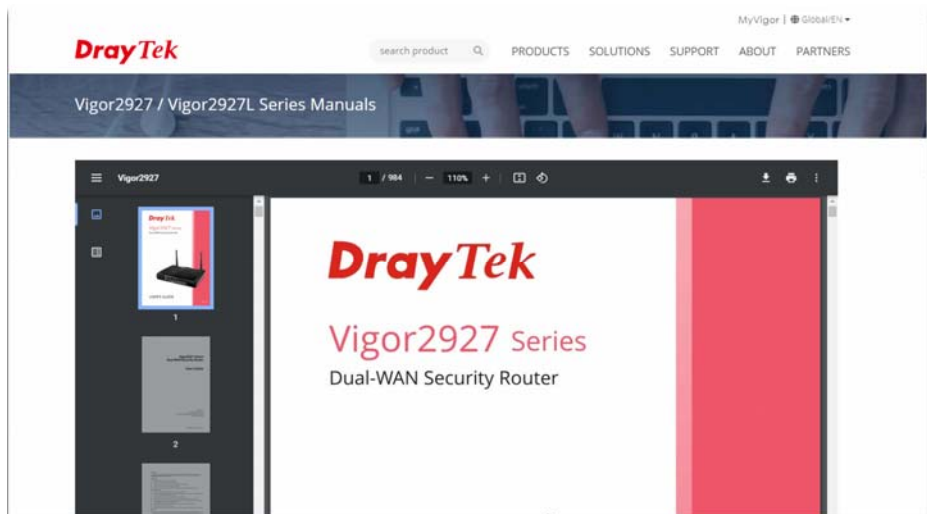

---

## I-5-9 Logout



Click this icon to exit the web user interface.

## I-5-10 Online Status

Online Status  
Physical Connection  
Virtual WAN

### I-5-10-1 Physical Connection

Such page displays the physical connection status such as LAN connection status, WAN connection status, and so on.

#### Physical Connection for IPv4 Protocol

Online Status

Physical Connection

System Uptime: 4days 23:49:54

IPv4		IPv6			
<b>LAN Status</b>					
IP Address	TX Packets	RX Packets	Router Primary DNS:	Router Secondary DNS:	
192.168.1.1	289,820	206,065	8.8.8.8	8.8.4.4	
<b>WAN 1 Status</b> >> <a href="#">Renew</a>					
Enable	Line	Name	Mode	Up Time	
Yes	Ethernet		DHCP Client	00:00:00	
IP	GW IP	TX Bytes	TX Rate(bps)	RX Bytes	RX Rate(bps)
---	---	0 (B)	0	0 (B)	0
<b>WAN 2 Status</b> >> <a href="#">Renew</a>					
Enable	Line	Name	Mode	Up Time	
Yes	Ethernet		DHCP Client	00:00:00	
IP	GW IP	TX Bytes	TX Rate(bps)	RX Bytes	RX Rate(bps)
---	---	0 (B)	0	0 (B)	0
<b>WAN 3 Status</b>					
Enable	Line	Name	Mode	Up Time	
No	Wireless 2.4G		---	00:00:00	
IP	GW IP	TX Bytes	TX Rate(bps)	RX Bytes	RX Rate(bps)
---	---	0 (B)	0	0 (B)	0
SSID	Channel	Security	PHY Mode	Rate	Signal Strength
	6	Disable	---	---	0%
<b>WAN 4 Status</b>					
Enable	Line	Name	Mode	Up Time	
No	Wireless 5G		---	00:00:00	
IP	GW IP	TX Bytes	TX Rate(bps)	RX Bytes	RX Rate(bps)
---	---	0	0	0	0
SSID	Channel	Security	PHY Mode	Rate	Signal Strength
	36	Disable	---	---	0%
<b>LTE Status</b>					
Enable	Line	Name	Mode	Up Time	Signal
Yes	USB		---	00:00:00	
IP	GW IP	TX Bytes	TX Rate(bps)	RX Bytes	RX Rate(bps)
---	---	0	0	0	0
<b>WAN 6 Status</b>					
Enable	Line	Name	Mode	Up Time	Signal
Yes	USB		---	00:00:00	
IP	GW IP	TX Bytes	TX Rate(bps)	RX Bytes	RX Rate(bps)
---	---	0	0	0	0

## Physical Connection for IPv6 Protocol

### Online Status

Physical Connection		System Uptime: 4days 23:50:56	
IPv4	IPv6		
<b>LAN Status</b>			
IP Address FE80::1649:BCFF:FE02:37E8/64 (Link)			
TX Packets 1,888	RX Packets 2,716	TX Bytes 147,336	RX Bytes 372,789
<b>WAN1 IPv6 Status</b>			
Enable No	Mode Offline	Up Time ---	Gateway IP ---
<b>WAN2 IPv6 Status</b>			
Enable No	Mode Offline	Up Time ---	Gateway IP ---
<b>WAN3 IPv6 Status</b>			
Enable No	Mode Offline	Up Time ---	Gateway IP ---
<b>WAN4 IPv6 Status</b>			
Enable No	Mode Offline	Up Time ---	Gateway IP ---
<b>LTE IPv6 Status</b>			
Enable No	Mode Offline	Up Time ---	Gateway IP ---
<b>WAN6 IPv6 Status</b>			
Enable No	Mode Offline	Up Time ---	Gateway IP ---

Detailed explanation (for IPv4) is shown below:

Item	Description
LAN Status	<p>Primary DNS-Displays the primary DNS server address for WAN interface.</p> <p>Secondary DNS -Displays the secondary DNS server address for WAN interface.</p> <p>IP Address-Displays the IP address of the LAN interface.</p> <p>TX Packets-Displays the total transmitted packets at the LAN interface.</p> <p>RX Packets-Displays the total received packets at the LAN interface.</p>
WAN1/WAN2/WAN3 /WAN4/WAN5/WAN6 Status	<p>Enable - Yes in red means such interface is available but not enabled. Yes in green means such interface is enabled.</p> <p>Mode - Displays the type of WAN connection (e.g., PPPoE).</p> <p>Up Time - Displays the total uptime of the interface.</p> <p>IP - Displays the IP address of the WAN interface.</p> <p>GW IP - Displays the IP address of the default gateway.</p> <p>TX Packets - Displays the total transmitted packets at the</p>



Item	Description
	WAN interface. TX Rate - Displays the speed of transmitted octets at the WAN interface. RX Packets - Displays the total number of received packets at the WAN interface. RX Rate - Displays the speed of received octets at the WAN interface.

Detailed explanation (for IPv6) is shown below:

Item	Description
LAN Status	IP Address- Displays the IPv6 address of the LAN interface.. TX Packets-Displays the total transmitted packets at the LAN interface. RX Packets-Displays the total received packets at the LAN interface. TX Bytes - Displays the speed of transmitted octets at the LAN interface. RX Bytes - Displays the speed of received octets at the LAN interface.
WAN IPv6 Status	Enable - No in red means such interface is available but not enabled. Yes in green means such interface is enabled. No in red means such interface is not available. Mode - Displays the type of WAN connection (e.g., TSPC). Up Time - Displays the total uptime of the interface. IP - Displays the IP address of the WAN interface. Gateway IP - Displays the IP address of the default gateway.



**Info**

The words in green mean that the WAN connection of that interface is ready for accessing Internet; the words in red mean that the WAN connection of that interface is not ready for accessing Internet.

### I-5-10-2 Virtual WAN

Such page displays the virtual WAN connection information.

Virtual WAN are used by TR-069 management, VoIP service and so on.

The field of Application will list the purpose of such WAN connection.

---

## I-6 Quick Start Wizard

Quick Start Wizard can help you to deploy and use the router easily and quickly.

Go to Wizards>>Quick Start Wizard. The first screen of Quick Start Wizard is entering login password. After typing the password, please click Next.

### Quick Start Wizard

---

#### Enter login password

Please enter an alpha-numeric string as your **Password** (Max 83 characters)

Old Password

New Password

Confirm Password

Password Strength: Weak Medium Strong

Strong password requirements:

1. Have at least one upper-case letter and one lower-case letter.
2. Including non-alphanumeric characters is a plus.

Hint: If you want to keep the password unchanged, leave the password blank and press "Next" button to skip this process.

On the next page as shown below, please select the WAN interface that you use. If Ethernet interface is used, please choose WAN1/WAN2; if 3G USB modem is used, please choose WAN3 or WAN4. Then click Next for next step.

### Wizards >> Quick Start Wizard

---

#### Select WAN Interface

Select WAN Interface:

Display Name:

Physical Mode: Ethernet

Physical Type:

VLAN Tag insertion:

Tag value  (0~4095)

Priority  (0~7)

WAN1, WAN2, WAN3, WAN4, WAN5 and WAN6 will bring up different configuration page. Refer to the following for detailed information.

## I-6-1 For WAN1/WAN2 (Ethernet)

WAN1/WAN2 can be configured for physical mode of Ethernet.

Wizards >> Quick Start Wizard

### Select WAN Interface

Select WAN Interface:	<input type="text" value="WAN1"/>
Display Name:	<input type="text"/>
Physical Mode:	Ethernet
Physical Type:	<input type="text" value="Auto negotiation"/>
VLAN Tag insertion:	<input type="text" value="Disable"/>
Tag value	<input type="text"/> (0~4095)
Priority	<input type="text"/> (0~7)

Available settings are explained as follows:

Item	Description
Display Name	Enter a name for the router.
Physical Type	This setting is available when Ethernet is selected as Physical Mode. In general, Auto negotiation is suggested.
VLAN Tag insertion	<p>The settings configured in this field are available when Ethernet is selected as Physical Mode.</p> <p>Disable - Disable the function of VLAN with tag. Enable - Enable the function of VLAN with tag.</p> <p>The router will add specific VLAN number to all packets on the WAN while sending them out.</p> <p>Please Enter the tag value and specify the priority for the packets sending by WAN.</p> <ul style="list-style-type: none"><li>● Tag value - Enter the value as the VLAN ID number. The range is form 0 to 4095.</li><li>● Priority - Enter the packet priority number for such VLAN. The range is from 0 to 7.</li></ul>

On the next page as shown below, please select the appropriate Internet access type according to the information from your ISP. For example, you should select PPPoE mode if the ISP provides you PPPoE interface. Then click Next for next step.

## Ethernet WAN1/2 - PPPoE

1. Choose WAN1 as the WAN Interface and choose Ethernet as the Physical Mode. Click the Next button. The following page will be open for you to specify Internet Access Type.

### Quick Start Wizard

#### Connect to Internet

**WAN 1**  
Select one of the following Internet Access types provided by your ISP.

PPPoE  
 PPTP  
 L2TP  
 Static IP  
 DHCP

< Back   Next >   Finish   Cancel

2. Click PPPoE as the Internet Access Type. Then click Next to continue.

### Quick Start Wizard

#### PPPoE Client Mode

**WAN 1**  
Enter the user name and password provided by your ISP.

Service Name (Optional)    CHT

Username    84005657@hinet.net

Password    .....

Confirm Password    .....

< Back   Next >   Finish   Cancel

Available settings are explained as follows:

Item	Description
Service Name (Optional)	Enter the description of the specific network service.
Username	Assign a specific valid user name provided by the ISP. Note: The maximum length of the user name you can set is 63 characters.
Password	Assign a valid password provided by the ISP. Note: The maximum length of the password you can set is 62 characters.

Item	Description
Confirm Password	Re-enter the password.
Back	Click it to return to previous setting page.
Next	Click it to get into the next setting page.
Cancel	Click it to give up the quick start wizard.

- Please manually enter the Username/Password provided by your ISP. Click Next for viewing summary of such connection.

Wizards >> Quick Start Wizard

Please confirm your settings:

WAN Interface:	WAN1
Physical Mode:	Ethernet
Physical Type:	Auto negotiation
Internet Access:	PPPoE

Click **Back** to modify changes if necessary. Otherwise, click **Finish** to save the current settings and restart the Vigor router.

- Click Finish. A page of Quick Start Wizard Setup OK!!! will appear. Then, the system status of this protocol will be shown.

**Quick Start Wizard Setup OK!**

- Now, you can enjoy surfing on the Internet.

## Ethernet WAN1/2 - PPTP/L2TP

1. Choose WAN1 as the WAN Interface and choose Ethernet as the Physical Mode. Click the Next button. The following page will be open for you to specify Internet Access Type.

### Quick Start Wizard

#### Connect to Internet

**WAN 1**  
Select one of the following Internet Access types provided by your ISP.

PPPoE  
 PPTP  
 L2TP  
 Static IP  
 DHCP

< Back   Next >   Finish   Cancel

2. Click PPTP/L2TP as the Internet Access Type. Then click Next to continue.

### Quick Start Wizard

#### PPTP Client Mode

**WAN 1**  
Enter the username, password, WAN IP configuration and PPTP server IP provided by your ISP.

Username   
Password   
Confirm Password

WAN IP Configuration  
 Obtain an IP address automatically  
 Specify an IP address

IP Address   
Subnet Mask   
Gateway   
Primary DNS   
Second DNS   
PPTP Server

< Back   Next >   Finish   Cancel

Available settings are explained as follows:

Item	Description
Username	Assign a specific valid user name provided by the ISP. Note: The maximum length of the user name you can set is 63 characters.
Password	Assign a valid password provided by the ISP. Note: The maximum length of the password you can set is 62 characters.

Confirm Password	ReEnter the password.
WAN IP Configuration	Obtain an IP address automatically - The router will get an IP address automatically from DHCP server. Specify an IP address - You have to type relational settings manually. IP Address - Enter the IP address. Subnet Mask - Enter the subnet mask. Gateway - Enter the IP address of the gateway. Primary DNS - Enter the primary IP address for the router. Second DNS - Enter secondary IP address for necessity in the future.
PPTP Server / L2TP Server	Enter the IP address of the server.
Back	Click it to return to previous setting page.
Next	Click it to get into the next setting page.
Cancel	Click it to give up the quick start wizard.

3. Please Enter the IP address/mask/gateway information originally provided by your ISP. Then click Next for viewing summary of such connection.

Wizards >> Quick Start Wizard

Please confirm your settings:

WAN Interface:	WAN1
Physical Mode:	Ethernet
Physical Type:	Auto negotiation
Internet Access:	PPTP
Click <b>Back</b> to modify changes if necessary. Otherwise, click <b>Finish</b> to save the current settings and restart the Vigor router.	

4. Click Finish. A page of Quick Start Wizard Setup OK!!! will appear. Then, the system status of this protocol will be shown.

**Quick Start Wizard Setup OK!**

5. Now, you can enjoy surfing on the Internet.

## Ethernet WAN1/2 - Static IP

1. Choose WAN1 as the WAN Interface and choose Ethernet as the Physical Mode. Click the Next button. The following page will be open for you to specify Internet Access Type.

Quick Start Wizard

---

Connect to Internet

**WAN 1**  
Select one of the following Internet Access types provided by your ISP.

PPPoE  
 PPTP  
 L2TP  
 Static IP  
 DHCP

2. Click Static IP as the Internet Access type. Simply click Next to continue.

Quick Start Wizard

---

Static IP Client Mode

**WAN 1**  
Enter the Static IP configuration provided by your ISP.

WAN IP	<input type="text" value="190.168.3.100"/>
Subnet Mask	<input type="text" value="255.255.255.0"/>
Gateway	<input type="text" value="192.168.3.1"/>
Primary DNS	<input type="text" value="8.8.8.8"/>
Secondary DNS	<input type="text" value="8.8.4.4"/> (optional)

Available settings are explained as follows:

Item	Description
WAN IP	Enter the IP address.
Subnet Mask	Enter the subnet mask.
Gateway	Enter the IP address of gateway.
Primary DNS	Enter the primary IP address for the router.
Secondary DNS	Enter the secondary IP address for necessity in the future.
Back	Click it to return to previous setting page.



Next	Click it to get into the next setting page.
Cancel	Click it to give up the quick start wizard.

3. Please Enter the IP address information originally provided by your ISP. Then click Next for next step.

Wizards >> Quick Start Wizard

Please confirm your settings:

WAN Interface:	WAN1
Physical Mode:	Ethernet
Physical Type:	Auto negotiation
Internet Access:	Static IP

Click **Back** to modify changes if necessary. Otherwise, click **Finish** to save the current settings and restart the Vigor router.

4. Click Finish. A page of Quick Start Wizard Setup OK!!! will appear. Then, the system status of this protocol will be shown.

**Quick Start Wizard Setup OK!**

5. Now, you can enjoy surfing on the Internet.

## Ethernet WAN1/2 - DHCP

1. Choose WAN1 as the WAN Interface and choose Ethernet as the Physical Mode. Click the Next button. The following page will be open for you to specify Internet Access Type.

### Quick Start Wizard

#### Connect to Internet

**WAN 1**  
Select one of the following Internet Access types provided by your ISP.

PPPoE  
 PPTP  
 L2TP  
 Static IP  
 DHCP

< Back   Next >   Finish   Cancel

2. Click DHCP as the Internet Access type. Simply click Next to continue.

### Quick Start Wizard

#### DHCP Client Mode

**WAN 1**  
If your ISP requires you to enter a specific host name or specific MAC address, please enter it in.

Host Name     (optional)  
MAC                (optional)

< Back   Next >   Finish   Cancel

Available settings are explained as follows:

Item	Description
Host Name	Enter the name of the host. Note: The maximum length of the host name you can set is 39 characters.
MAC	Some Cable service providers specify a specific MAC address for access authentication. In such cases you need to enter the MAC address.
Back	Click it to return to previous setting page.

Next	Click it to get into the next setting page.
Cancel	Click it to give up the quick start wizard.

- After finished the settings above, click Next for viewing summary of such connection.

Wizards >> Quick Start Wizard

Please confirm your settings:

WAN Interface:	WAN1
Physical Mode:	Ethernet
Physical Type:	Auto negotiation
Internet Access:	DHCP
<p>Click <b>Back</b> to modify changes if necessary. Otherwise, click <b>Finish</b> to save the current settings and restart the Vigor router.</p>	

- Click Finish. A page of Quick Start Wizard Setup OK!!! will appear. Then, the system status of this protocol will be shown.

**Quick Start Wizard Setup OK!**

- Now, you can enjoy surfing on the Internet.

---

## I-6-2 For WAN3/WAN4 (Wireless 2.4G/Wireless 5G)

WAN3/WAN4 shall be used for wireless (2.4G or 5G) connection.

### Wireless WAN3/WAN4 - Static IP

1. Choose WAN3/WAN4 as WAN Interface and choose Wireless 2.4G or Wireless 5G as the physical mode.

Quick Start Wizard

---

#### Select WAN Interface

Select WAN Interface:	WAN3 ▾
Display Name:	<input type="text"/>
Physical Mode:	Wireless 2.4G
Physical Type:	Auto negotiation ▾

or

Quick Start Wizard

---

#### Select WAN Interface

Select WAN Interface:	WAN4 ▾
Display Name:	<input type="text"/>
Physical Mode:	Wireless 5G
Physical Type:	Auto negotiation ▾

- Then, click Next for getting the following page.

Quick Start Wizard

---

Connect to Internet

**WAN 3**  
Select one of the following Internet Access types.

Static IP

DHCP

- After click Static IP as the Internet Access type, you will get the following page. Enter the required information and click Next to continue.

Quick Start Wizard

---

Static IP Client Mode

**WAN 3**  
Enter the Static IP configuration.

WAN IP

Subnet Mask

Gateway

Available settings are explained as follows:

Item	Description
WAN IP	Enter the IP address.
Subnet Mask	Enter the subnet mask.
Gateway	Enter the IP address of gateway.
Back	Click it to return to previous setting page.
Next	Click it to get into the next setting page.
Cancel	Click it to give up the quick start wizard.

- From the following page, enter the SSID of an existed AP as the wireless connection server for this WAN. Or click AP Discovery to find an access point as the server for this WAN interface. Click Next to continue.

Wizards >> Quick Start Wizard

Connect to Internet

**WAN 3**

Enter the AP configuration that router wants to connect.

SSID

MAC Address (Optional)

Channel :

Security Mode

- Then, a summary of the connection will be shown on the screen.

Quick Start Wizard

Please confirm your settings:

WAN Interface: WAN3

Physical Mode: Wireless 2.4G

Internet Access: Static IP

Click **Back** to modify changes if necessary. Otherwise, click **Finish** to save the current settings and restart the Vigor router.

- Click Finish. A page of Quick Start Wizard Setup OK!!! will appear. Then, the system status of this protocol will be shown.

**Quick Start Wizard Setup OK!**

- Now, you can enjoy surfing on the Internet.

## Wireless WAN3/WAN4 - DHCP

1. Choose WAN3/WAN4 as WAN Interface and choose Wireless 2.4G or Wireless 5G as the physical mode.

### Quick Start Wizard

---

#### Select WAN Interface

Select WAN Interface:	WAN3 ▾
Display Name:	<input type="text"/>
Physical Mode:	Wireless 2.4G
Physical Type:	Auto negotiation ▾

or

### Quick Start Wizard

---

#### Select WAN Interface

Select WAN Interface:	WAN4 ▾
Display Name:	<input type="text"/>
Physical Mode:	Wireless 5G
Physical Type:	Auto negotiation ▾

- Then, click Next for getting the following page.

Quick Start Wizard

---

Connect to Internet

**WAN 3**  
Select one of the following Internet Access types.

Static IP  
 DHCP

- After click DHCP as the Internet Access type, you will get the following page. Enter the SSID of an existed AP as the wireless connection server for this WAN. Or click AP Discovery to find an access point as the server for this WAN interface. Click Next to continue.

Quick Start Wizard

---

Connect to Internet

**WAN 3**  
Enter the AP configuration that router wants to connect.

SSID

MAC Address (Optional)

Channel :

Security Mode

Encryption Mode

Pass Phrase

Available settings are explained as follows:

Item	Description
SSID	Enter the SSID of an existed AP. Or click AP Discovery to find an access point as the server for this WAN interface.
MAC Address	Enter the MAC address of an existed AP.
Channel	Choose a channel of frequency of the Wireless AP.
Security Mode	The Router connects to the wireless AP as a WEP, WPA or WPA2 client. Select a mode to connect to the Wireless AP.
Encryption Mode	WPA/PSK uses TKIP as Encryption Mode. WPA2/PSK uses AES as Encryption Mode.



Pass Phrase	It is available when WPA/PSK or WPA2/PSK is enabled.
WEP Keys	It is available when WEP is enabled.
Back	Click it to return to previous setting page.
Next	Click it to get into the next setting page.
Cancel	Click it to give up the quick start wizard.

- Then, a summary of the connection will be shown on the screen.

Quick Start Wizard

Please confirm your settings:

WAN Interface:	WAN3
Physical Mode:	Wireless 2.4G
Internet Access:	DHCP

Click **Back** to modify changes if necessary. Otherwise, click **Finish** to save the current settings and restart the Vigor router.

- Click **Finish**. A page of Quick Start Wizard Setup OK!!! will appear. Then, the system status of this protocol will be shown.

**Quick Start Wizard Setup OK!**

- Now, you can enjoy surfing on the Internet.

## I-6-3 For WAN5/WAN6 (USB)

WAN3/WAN4 is dedicated to physical mode in USB.

1. Choose WAN5/WAN6 as WAN Interface. For "L" model, the WAN5 will be changed as LTE.

Quick Start Wizard

WAN Interface

WAN Interface:	WAN6 ▼
Display Name:	<input type="text"/>
Physical Mode:	<input type="text"/>

< Back    Next >    Finish    Cancel

2. Then, click Next for getting the following page.

Quick Start Wizard

Connect to Internet

<b>WAN 6</b>	
Internet Access :	3G/4G USB Modem(PPP mode) ▼
3G/4G USB Modem(PPP mode)	3G/4G USB Modem(PPP mode)
SIM PIN code	3G/4G USB Modem(DHCP mode)
Modem Initial String	<input type="text"/>
APN Name	AT&FE0V1X1&D2&C1S0=0
	(Default:AT&FE0V1X1&D2&C1S0=0)
	<input type="text"/>
	Apply

< Back    Next >    Finish    Cancel

Available settings are explained as follows:

Item	Description
Internet Access	Choose one of the selections as the protocol of accessing the internet.
3G/4G USB Modem (PPP mode)	SIM Pin code - Type PIN code of the SIM card that will be used to access Internet. The maximum length of the pin code you can set is 15 characters. Modem Initial String - Such value is used to initialize USB modem. Please use the default value. If you have any question, please contact to your ISP. The maximum length of the string you can set is 47 characters.

	APN Name - APN means Access Point Name which is provided and required by some ISPs. Enter the name and click <b>Apply</b> .
3G/4G USB Modem (DHCP mode)	SIM Pin code - Type PIN code of the SIM card that will be used to access Internet. Network Mode - Force Vigor router to connect Internet with the mode specified here. If you choose 4G/3G/2G as network mode, the router will choose a suitable one according to the actual wireless signal automatically. APN Name - APN means Access Point Name which is provided and required by some ISPs.
Back	Click it to return to previous setting page.
Next	Click it to get into the next setting page.
Cancel	Click it to give up the quick start wizard.

- Then, click Next for viewing summary of such connection.

Wizards >> Quick Start Wizard

Please confirm your settings:

WAN Interface:	WAN6
Physical Mode:	USB
Internet Access:	PPP
Click <b>Back</b> to modify changes if necessary. Otherwise, click <b>Finish</b> to save the current settings and restart the Vigor router.	

< Back    Next >    Finish    Cancel

- Click Finish. A page of Quick Start Wizard Setup OK!!! will appear. Then, the system status of this protocol will be shown.

**Quick Start Wizard Setup OK!**

- Now, you can enjoy surfing on the Internet.

# I-7 Service Activation Wizard

Service Activation Wizard can guide you to activate WCF service (Web Content Filter) with a quick and easy way. For the Service Activation Wizard is only available for admin operation, therefore, please type "admin/admin" on Username/Password while Logging into the web user interface.

Service Activation Wizard is a tool which allows you to use trial version of WCF directly without accessing into the server (**MyVigor**) located on <http://myvigor.draytek.com>. For using Web Content Filter Profile, please refer to later section Web Content Filter Profile for detailed information.

Now, follow the steps listed below to activate WCF feature for your router.



Info

Such function is available only for Admin Mode.

1. Open Wizards>>Service Activation Wizard.

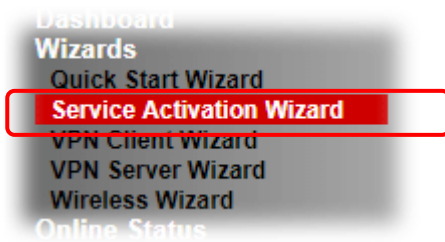

2. The screen of Service Activation Wizard will be shown as follows. You can activate the Web content filter services and/or APPE enforcement service and / or DDNS service at the same time or individually. When you finish the selection, please click Next.

### Service Activation Wizard

Select the service type that you want to activate

Activation Date : 2018-04-23

**Web Content Filter(WCF) Service :**

3PJM [License Agreement](#)  
This is a web content filter that is provided by the German government. It is a free service without any guarantee and will expire one year after activation. You may re-activate the service after expiry.

Cyren 30-Days Free Trial [License Agreement](#)  
This is a worldwide web content filter service. The free trail license can only be used once. At the end of the free trail period you may purchase the official one-year Cyren Web Content Filter from an authorized DrayTek reseller.

**APP Enforcement(APPE) Service :**

DT-APPE [License Agreement](#)  
Upgrade APPE Signature automatically.

**Dynamic DNS(DDNS) Service :**

DT-DDNS [License Agreement](#)  
This is a Dynamic Domain Name Service that is provided by DrayTek company. It is a free service will expire 1 year after activation.  
You may re-active the service after expiry.

Domain Name : .draydns.com

I have read and accept the above Agreement. (Please check this box).



**Info**

- BPjM is web content filter (WCF) for German Speaking users. It is ideal for your family to provide more Internet security for youngsters.
- Cryan 30-day trial is WCF which offers 30-day trial period.
- DT-APPE, developed by DrayTek, offers a mechanism to upgrade APPE signature automatically.
- DT-DDNS, developed by DrayTek, offers one year free charge service of dynamic DNS service for internal use.

3. Setting confirmation page will be displayed as follows, please click Activate.

**Service Activation Wizard**

**Please confirm your settings**

Service Type : Trial version  
Service Activated : Web Content Filter ( Cyren / Commtouch )  
APP Enforcement ( DT-APPE )  
Dynamic DNS ( 2018042313200201.drayddns.com )

Please click **Back** to re-select service type you to activate.



**Info**

The service will be activated and applied as the default rule configured in Firewall>>General Setup.

4. Now, the web page will display the service that you have activated according to your selection(s).

**Service Activation Wizard**

**Please confirm your settings**

Service Type : Trial version  
Service Activated : Web Content Filter ( Cyren / Commtouch )  
APP Enforcement ( DT-APPE )  
Dynamic DNS ( 2018042313200201.drayddns.com )

Please click **Back** to re-select service type you to activate.

---

## I-8 Registering Vigor Router

You have finished the configuration of Quick Start Wizard and you can surf the Internet at any time. Now it is the time to register your Vigor router to MyVigor website for getting more service. Please follow the steps below to finish the router registration.

- 1 Please login the web configuration interface of Vigor router by typing “admin/admin” as User Name / Password.

**DrayTek** Vigor2927 Series

**Login**

Username

Password

Language  ▼

**Login**

**Security Warning: You are logging in without encryption which is not recommended. To login securely [click here](#).**

Copyright© 2000-2022 DrayTek Corp. All Rights Reserved.

- 2 Click MyVigor Services>>Production Registration from the home page.

**MyVigor Services**  
**Product Registration**  
**Service Status**

- 3 A Login page will be shown on the screen. Please Enter the account and password that you created previously. And click Login.

The MyVigor website does not record any personal identifiable information with the exception of your IP Address which is recorded after login for security purposes.

ENGLISH

**DrayTek**  
MyVigor

Username  
carrieni

Password  
••••••

**Login**

[Create Account / Get Help](#)

Copyright@DrayTek Corp Terms of Service / Privacy Policy



### Info

If you haven't an accessing account, please refer to section Creating an Account for MyVigor to create your own one. Please read the articles on the Agreement regarding user rights carefully while creating a user account.

- The following page will be displayed after you logging in MyVigor. Type a nickname for the router, then click Submit.

Product register ( Add Device )

Device Name	Vigor2927Lac
Model	Vigor2927
MAC	1449BC0237E8
Serial Number	2019122611165901

Submit

- When the following page appears, your router information has been added to the database. Your router has been registered to *myvigor* website successfully.

MyVigor MY PRODUCT HIGH AVAILABILITY SETTINGS CUSTOMER SURVEY AGENT

WCF APPE DrayDDNS  
Cyren BPJM

License Status ●

License Action **Activate License** Force Sync

License History

Today  
2019-12-26

Product Registration  
2019-12-26

- 6 Clicking MYPRODUCT for viewing the general information of the registered router on MyVigor website.

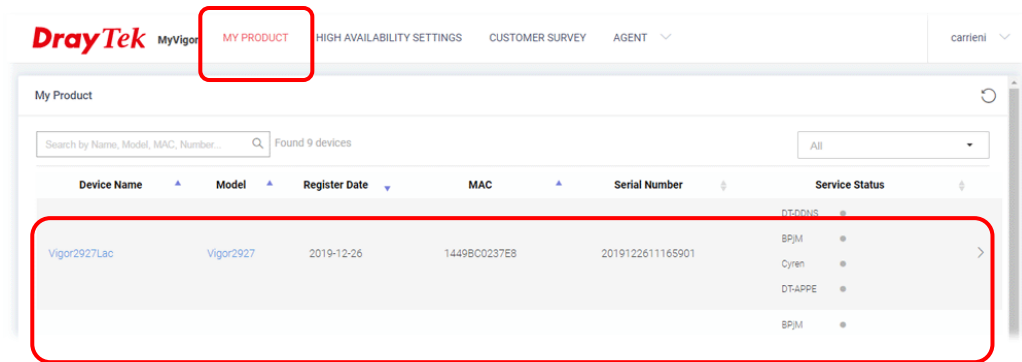



# Part II Connectivity



WAN

It means wide area network. Public IP will be used in WAN.



LAN

It means local area network. Private IP will be used in LAN. Local Area Network (LAN) is a group of subnets regulated and ruled by router. The design of network structure is related to what type of public IP addresses coming from your ISP.



NAT

When the data flow passing through, the Network Address Translation (NAT) function of the router will dedicate to translate public/private addresses, and the packets will be delivered to the correct host PC in the local area network.



Applications

DNS, LAN DNS, LDAP, UPnP, IGMP, Wake on LAN/WAN, RADIUS/TACACS+, SMS/Mail Alert, Bonjour, High Availability, Local 802.1x



Routing

Static Route, Load-Balance/Route Policy, BGP

---

## II-1 WAN

It allows users to access Internet.

### Basics of Internet Protocol (IP) Network

IP means Internet Protocol. Every device in an IP-based Network including routers, print server, and host PCs, needs an IP address to identify its location on the network. To avoid address conflicts, IP addresses are publicly registered with the Network Information Centre (NIC). Having a unique IP address is mandatory for those devices participated in the public network but not in the private TCP/IP local area networks (LANs), such as host PCs under the management of a router since they do not need to be accessed by the public. Hence, the NIC has reserved certain addresses that will never be registered publicly. These are known as *private* IP addresses, and are listed in the following ranges:

From 10.0.0.0 to 10.255.255.255  
From 172.16.0.0 to 172.31.255.255  
From 192.168.0.0 to 192.168.255.255

### What are Public IP Address and Private IP Address

As the router plays a role to manage and further protect its LAN, it interconnects groups of host PCs. Each of them has a private IP address assigned by the built-in DHCP server of the Vigor router. The router itself will also use the default private IP address: 192.168.1.1 to communicate with the local hosts. Meanwhile, Vigor router will communicate with other network devices through a public IP address. When the data flow passing through, the Network Address Translation (NAT) function of the router will dedicate to translate public/private addresses, and the packets will be delivered to the correct host PC in the local area network. Thus, all the host PCs can share a common Internet connection.

### Get Your Public IP Address from ISP

In ADSL deployment, the PPP (Point to Point)-style authentication and authorization is required for bridging customer premises equipment (CPE). Point to Point Protocol over Ethernet (PPPoE) connects a network of hosts via an access device to a remote access concentrator or aggregation concentrator. This implementation provides users with significant ease of use. Meanwhile it provides access control, billing, and type of service according to user requirement.

When a router begins to connect to your ISP, a serial of discovery process will occur to ask for a connection. Then a session will be created. Your user ID and password is authenticated via PAP or CHAP with RADIUS authentication system. And your IP address, DNS server, and other related information will usually be assigned by your ISP.

### Network Connection by 3G/4G USB Modem

For 3G/4G mobile communication through Access Point is popular more and more, Vigor2927 adds the function of 3G/4G network connection for such purpose. By connecting 3G/4G USB Modem to the USB port of Vigor2927, it can support LTE/HSDPA/UMTS/EDGE/GPRS/GSM and the future 3G/4G standard (HSUPA, etc). Vigor2927n with 3G/4G USB Modem allows you to receive 3G/4G signals at any place such as your car or certain location holding outdoor activity and share the bandwidth for using by more people. Users can use LAN ports on the router to access Internet. Also, they can access Internet via 802.11(a/b/g/n/ac) wireless standard, and enjoy the powerful firewall, bandwidth management, and VPN features of Vigor2927n series.

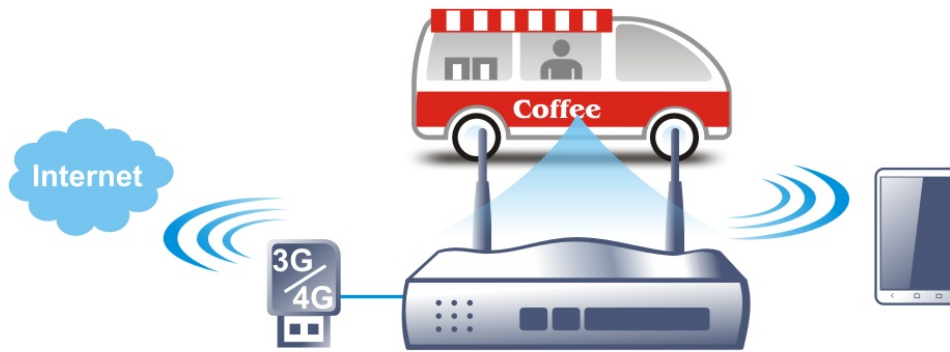

After connecting into the router, 3G/4G USB Modem will be regarded as the WAN3/WAN4 port. However, the original WAN1 and WAN2 still can be used and Load-Balance can be done in the router. Besides, 3G/4G USB Modem in WAN3/WAN4 also can be used as backup device. Therefore, when WAN1 and WAN2 are not available, the router will use 3.5G for supporting automatically. The supported 3G/4G USB Modem will be listed on DrayTek web site. Please visit [www.draytek.com](http://www.draytek.com) for more detailed information.

# Web User Interface

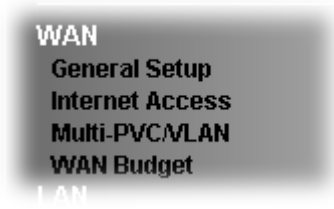

## II-1-1 General Setup

This section will introduce some general settings of Internet and explain the connection modes for WAN1, WAN2, WAN3, WAN4, WAN5/LTE and WAN6 in details.

This router supports multiple-WAN function. It allows users to access Internet and combine the bandwidth of the multiple WANs to speed up the transmission through the network. Each WAN port can connect to different ISPs, even if the ISPs use different technology to provide telecommunication service (such as DSL, Cable modem, etc.). If any connection problem occurred on one of the ISP connections, all the traffic will be guided and switched to the normal communication port for proper operation. Please configure WAN1, WAN2, WAN3, WAN4, WAN5/LTE and WAN6 settings.

This webpage allows you to set general setup for WAN1, WAN2, WAN3, WAN4, WAN5/LTE and WAN6 respectively.

WAN >> General Setup

General Setup

Index	Enable	Physical Mode/Type	Bandwidth(Kbps) DownLink/UpLink	Latency	Jitter	Pkt.Loss	Active Mode	Load Balance
WAN1	<input checked="" type="checkbox"/>	Ethernet/Auto negotiation	- / -	-	-	-	Always On	<input checked="" type="checkbox"/>
WAN2	<input checked="" type="checkbox"/>	Ethernet/Auto negotiation	- / -	-	-	-	Always On	<input checked="" type="checkbox"/>
WAN3	<input checked="" type="checkbox"/>	Wireless 2.4G/-	- / -	-	-	-	Always On	<input checked="" type="checkbox"/>
WAN4	<input type="checkbox"/>	Wireless 5G/-	- / -	-	-	-	Always On	<input checked="" type="checkbox"/>
LTE	<input checked="" type="checkbox"/>	USB/-	- / -	-	-	-	Always On	<input checked="" type="checkbox"/>
WAN6	<input checked="" type="checkbox"/>	USB/-	- / -	-	-	-	Always On	<input checked="" type="checkbox"/>

Load Balance Setup

Advance

Mode	IP Based
Line Speed	Auto Detect
Load Balance Weights	Bandwidth-Based

Note:

1. Latency,jitter,and packet-loss require setting Link Condition Detection in each WAN setting page.
2. When WAN2 is not Ethernet, P6 port will be used as LAN.

OK

Cancel

Available settings are explained as follows:

Item	Description
Index	Click the WAN interface link under Index to access into the WAN configuration page.
Enable	V means such WAN interface is enabled and ready to be used.
Physical Mode / Type	Display the physical mode and physical type of such WAN interface.
Bandwidth(Kbps) DownLink/UpLink	Display the downstream and upstream rate of such WAN interface.

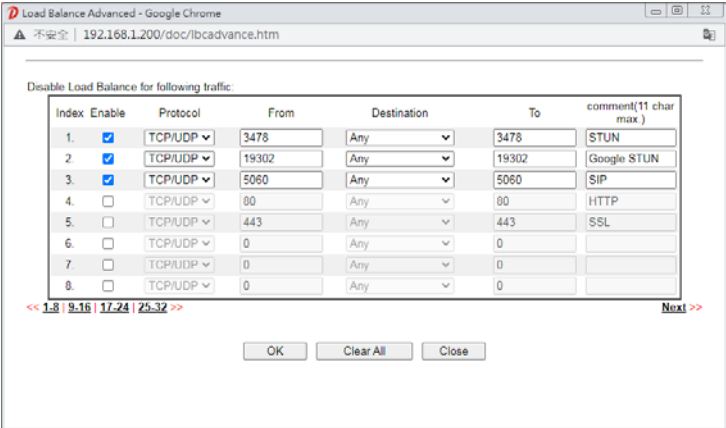
Active Mode	<p>Display whether such WAN interface is Active device or backup device.</p> <p>Backup (WAN#) - Display the backup WAN interface for such WAN when it is disabled.</p>
Load Balance	Select to enable the load balance function.
Load Balance Setup	<p>Advance - Load Balance for the traffic of STUN, google STUN, and SIP are disabled in default to prevent from conflict. The following dialog allows you to define protocol, port and name for the traffic not to be applied with load balance. That is, when an item is enabled (checked), it might not be affected by load balance.</p> 
Mode	<p>IP Based - The same source / destination IP pair will select the same WAN interface as policy. It is the default setting.</p> <p>Session Based- All of the WAN interfaces will be used (as out-going WAN) for passing through new sessions to get better transmission speed. Though good speed test result for throughput might be reached; however, some web site may not open smoothly, especially the site need authentication, e.g., FTP.</p> <p>If you have no strong demand about speed test result, keep default settings as IP based.</p>
Line Speed	This option is available for multiple-WAN for getting enough bandwidth for each WAN port. If you know the practical bandwidth for your WAN interface, please choose the setting of According to Line Speed. Otherwise, please choose Auto Detect to let the router reach the best load balance.
Load Balance Weights	<p>There are four weight types for choosing to meet your request.</p> <p>Custom - You can distribute the usage ratio for each WAN interface by setting weights for bandwidth, latency, jitter, and packet loss respectively.</p>

Load Balance Weights Custom

**Upload Bandwidth**  
Weight: Low High

**Download Bandwidth**  
Weight: Low High

**Low Latency**  
Weight: Low High

**Low Jitter**  
Weight: Low High

**Less Packet Loss**  
Weight: Low High

- **Upload / Download Bandwidth** - The higher the weight is, the WAN interface with higher bandwidth will get higher usage.
- **Low Latency** - It defines the time taken by Vigor router when sending the packets to the IP set in Link Condition Detection. The higher the weight is, the WAN interface with lower latency will get higher usage.
- **Low Jitter** - It defines the change rate of latency. For stable session, small jitter value will be better. The higher the weight is, the WAN interface with lower jitter will get higher usage.
- **Less Packet Loss** - It defines the proportion that packets will be discarded before arriving at the IP set in Link Condition Detection. The higher the weight is, the WAN interface with lower packet loss will get higher usage.

**Bandwidth-Based** - The load balance weight for each WAN will be executed according to line speed setting (DownLink/UpLink Rate). This is default setting.

**Quality-Based** - The load balance weight for each WAN will be executed according to the transmission rate, latency time and the jitter time.

**Reliability-Based** - The load balance weight for each WAN will be executed according to line speed and packet loss value. Usually, the WAN interface with low packet loss will have the higher ratio to be used.



Info

Wired router (e.g., Vigor2927) does not support WAN3 and WAN4.

After finished the above settings, click OK to save the settings.

## II-1-1-1 WAN1/WAN2 (Ethernet)

WAN1/WAN2 can be configured for physical mode of Ethernet.

WAN >> General Setup

### WAN 1

Enable:	Yes ▾	
Display Name:	<input type="text"/>	
Physical Mode:	Ethernet	
Physical Type (Ethernet):	Auto negotiation ▾	
Line Speed(Kbps):		
DownLink	<input type="text" value="0"/>	
UpLink	<input type="text" value="0"/>	
Link Condition Detection		
Mode	Ping Detect ▾	
Primary Ping IP	<input type="text" value="8.8.8.8"/>	
Secondary Ping IP	<input type="text" value="8.8.4.4"/>	
Ping Interval	<input type="text" value="1"/> Seconds(s)	
Active Mode:	Backup ▾	
Backup For	<input type="checkbox"/> WAN 1	
	<input type="checkbox"/> WAN 2	
	<input type="checkbox"/> WAN 3	
	<input type="checkbox"/> WAN 4	
	<input type="checkbox"/> LTE	
	<input type="checkbox"/> WAN 6	
Active When	Any ▾ of the WAN selected above	
	<input type="radio"/> Fails to connect: <input checked="" type="radio"/> Meet Any ▾ of the following conditions:	
	<input type="checkbox"/> Upload traffic reaches <input type="text" value="0"/> Kbps	
	<input type="checkbox"/> Download traffic reaches <input type="text" value="0"/> Kbps	
	<input type="checkbox"/> Latency over <input type="text" value="0"/> ms	
	<input type="checkbox"/> Jitter over <input type="text" value="0"/> ms	
	<input type="checkbox"/> Packet loss over <input type="text" value="0"/> %	
VLAN Tag insertion	Customer (TPID 0x8100)	Service (TPID 0x8100)
	<input type="text" value="Disable"/> ▾ Tag value    Priority <input type="text" value="0"/> <input type="text" value="0"/> (0~4095)    (0~7)	<input type="text" value="Disable"/> ▾ Tag value    Priority <input type="text" value="0"/> <input type="text" value="0"/> (0~4095)    (0~7)

Available settings are explained as follows:

Item	Description
Enable	Choose Yes to invoke the settings for this WAN interface. Choose No to disable the settings for this WAN interface.
Display Name	Enter the description for such WAN interface.
Physical Mode	Display the physical mode (Ethernet) of the interface.
Physical Type	You can change the physical type for WAN1/2 or choose Auto negotiation for determined by the system.
Line Speed (Kbps)	If you choose According to Line Speed as the Line Speed on WAN>>General Setup, please enter the line speed for downloading and uploading for such WAN interface. The unit is kbps.
Link Condition Detection	In order for the system to detect the latency, jitter, and packet-loss status for each WAN interface, you have to specify the IP transmitting data through the interface. Mode - Choose Ping Detect, Http Detect, or Disable as detection mode. If Ping Detect or Http Detect is selected,

	<p>you have to configure the following option.</p> <ul style="list-style-type: none"> <li>● Primary Ping IP - Enter an IP address.</li> <li>● Secondary Ping IP - Enter an IP address.</li> <li>● Ping Interval - Set a time interval (unit:second) for the system to ping the IP address specified above.</li> </ul>
Active Mode	<p>Always On - WAN is always enabled.</p> <p>Backup - WAN is enabled only when other WAN ports specified in Backup For (see below), have lost connection.</p> <ul style="list-style-type: none"> <li>● Backup For - Select the WANs for which this WAN is intended to serve as a backup.</li> <li>● Active When - Set the condition for backup connection. <ul style="list-style-type: none"> <li>- Any - The selected WAN(s) will be activated when any master WAN interface disconnects.</li> <li>- All - All of the backup WANs will be activated only when all master WAN interface disconnects.</li> <li>- Fails to connect - When the active WAN failed, the WAN selected above will be activated as the main network connection.</li> <li>- Meet All/Any of the following conditions - When the upload traffic, download traffic, latency, jitter and/or packet loss of active WAN reaches the traffic threshold (specified here), the backup WAN will be enabled automatically to share the overloaded data traffic.</li> </ul> </li> </ul>
VLAN Tag insertion	<p>Such feature is offered to the user with the environment supporting IEEE_802.1ad. In which, service is used for outer tag; customer is used for inner tag.</p> <p>It is available only when Ethernet is selected as Physical Mode.</p> <p>Disable - Disable the function of VLAN with tag.</p> <p>Enable -Enable the function of VLAN with tag.</p> <p>The router will add specific VLAN number to all packets on the WAN while sending them out.</p> <p>Please Enter the tag value and specify the priority for the packets sending by WAN1.</p> <ul style="list-style-type: none"> <li>● Tag value - Enter the value as the VLAN ID number. The range is form 0 to 4095.</li> <li>● Priority - Enter the packet priority number for such VLAN. The range is from 0 to 7.</li> </ul>

After finished the above settings, click OK to save the settings.



## II-1-1-2 WAN3/WAN4 (Wireless 2.4G or 5G)

WAN3/WAN4 can be configured for physical mode of Wireless 2.4G or Wireless 5G.

WAN >> General Setup

**WAN 3**

Enable:	Yes ▾
Display Name:	<input type="text"/>
Physical Mode:	Wireless 2.4G ▾
Line Speed(Kbps):	
DownLink	<input type="text" value="0"/>
UpLink	<input type="text" value="0"/>
Link Condition Detection	
Mode	Ping Detect ▾
Primary Ping IP	<input type="text" value="8.8.8.8"/>
Secondary Ping IP	<input type="text" value="8.8.4.4"/>
Ping Interval	<input type="text" value="10"/> Seconds(s)
Active Mode:	Backup ▾
Backup For	<input type="checkbox"/> WAN 1 <input type="checkbox"/> WAN 2 <input type="checkbox"/> WAN 3 <input type="checkbox"/> WAN 4 <input type="checkbox"/> LTE <input type="checkbox"/> WAN 6
Active When	Any ▾ of the WAN selected above
	<input type="radio"/> Fails to connect: <input checked="" type="radio"/> Meet Any ▾ of the following conditions: <ul style="list-style-type: none"> <li><input type="checkbox"/> Upload traffic reaches <input type="text" value="0"/> Kbps</li> <li><input type="checkbox"/> Download traffic reaches <input type="text" value="0"/> Kbps</li> <li><input type="checkbox"/> Latency over <input type="text" value="0"/> ms</li> <li><input type="checkbox"/> Jitter over <input type="text" value="0"/> ms</li> <li><input type="checkbox"/> Packet loss over <input type="text" value="0"/> %</li> </ul>

**Note:**

The line speed setting of WAN interface is available only when According to Line Speed is selected as the Load Balance Mode.

OK Cancel

Available settings are explained as follows:

Item	Description
Enable	Choose Yes to invoke the settings for this WAN interface. Choose No to disable the settings for this WAN interface.
Display Name	Enter the description for such WAN interface.
Physical Mode	Choose the physical mode (Wireless 2.4G / Wireless 5G) of the interface.
Line Speed (Kbps)	If you choose According to Line Speed as the Line Speed on WAN>>General Setup, please enter the line speed for downloading and uploading for such WAN interface. The unit is kbps.
Link Condition Detection	In order for the system to detect the latency, jitter, and packet-loss status for each WAN interface, you have to specify the IP transmitting data through the interface. Mode - Choose Ping Detect, Http Detect, or Disable as detection mode. If Ping Detect or Http Detect is selected, you have to configure the following option. <ul style="list-style-type: none"> <li>● Primary Ping IP - Enter an IP address.</li> <li>● Secondary Ping IP - Enter an IP address.</li> <li>● Ping Interval - Set a time interval (unit:second) for the system to ping the IP address specified above.</li> </ul>
Active Mode	Always On - WAN is always enabled. Backup - WAN is enabled only when other WAN ports

specified in Backup For (see below), have lost connection.

- Backup For - Select the WANs for which this WAN is intended to serve as a backup.
- Active When - Set the condition for backup connection.
  - Any - The selected WAN(s) will be activated when any master WAN interface disconnects.
  - All - All of the backup WANs will be activated only when all master WAN interface disconnects.
  - Fails to connect - When the active WAN failed, the WAN selected above will be activated as the main network connection.
  - Meet All/Any of the following conditions - When the upload traffic, download traffic, latency, jitter and/or packet loss of active WAN reaches the traffic threshold (specified here), the backup WAN will be enabled automatically to share the overloaded data traffic.

After finished the above settings, click OK to save the settings.

### II-1-1-3 WAN5 / WAN6 (USB) or LTE

To use 3G/4G network connection through 3G/4G USB Modem, please configure WAN5 or LTE / WAN6 interface.

WAN >> General Setup

#### WAN 6

Enable:	Yes ▾
Display Name:	<input type="text"/>
Physical Mode:	USB
Line Speed(Kbps):	
DownLink	<input type="text" value="0"/>
UpLink	<input type="text" value="0"/>
Link Condition Detection Mode	Ping Detect ▾
Primary Ping IP	<input type="text" value="8.8.8.8"/>
Secondary Ping IP	<input type="text" value="8.8.4.4"/>
Ping Interval	<input type="text" value="10"/> Seconds(s)
Active Mode:	Backup ▾
Backup For	<input type="checkbox"/> WAN 1 <input type="checkbox"/> WAN 2 <input type="checkbox"/> WAN 3 <input type="checkbox"/> WAN 4 <input type="checkbox"/> LTE <input type="checkbox"/> WAN 6
Active When	Any ▾ of the WAN selected above
	<input type="radio"/> Fails to connect: <input checked="" type="radio"/> Meet Any ▾ of the following conditions: <input type="checkbox"/> Upload traffic reaches <input type="text" value="0"/> Kbps <input type="checkbox"/> Download traffic reaches <input type="text" value="0"/> Kbps <input type="checkbox"/> Latency over <input type="text" value="0"/> ms <input type="checkbox"/> Jitter over <input type="text" value="0"/> ms <input type="checkbox"/> Packet loss over <input type="text" value="0"/> %

**Note:**

The line speed setting of WAN interface is available only when According to Line Speed is selected as the Load Balance Mode.

OK Cancel

Available settings are explained as follows:

Item	Description
Enable	Choose Yes to invoke the settings for this WAN interface. Choose No to disable the settings for this WAN interface.
Display Name	Enter the description for such WAN interface.

Physical Mode	Display the physical mode of such WAN interface.
Line Speed (Kbps)	If you choose According to Line Speed as the Line Speed on WAN>>General Setup, please enter the line speed for downloading and uploading for such WAN interface. The unit is kbps.
Link Condition Detection	<p>In order for the system to detect the latency, jitter, and packet-loss status for each WAN interface, you have to specify the IP transmitting data through the interface.</p> <p>Mode - Choose Ping Detect, Http Detect, or Disable as detection mode. If Ping Detect or Http Detect is selected, you have to configure the following option.</p> <ul style="list-style-type: none"> <li>● Primary Ping IP - Enter an IP address.</li> <li>● Secondary Ping IP - Enter an IP address.</li> <li>● Ping Interval - Set a time interval (unit:second) for the system to ping the IP address specified above.</li> </ul>
Active Mode	<p>Always On - WAN is always enabled.</p> <p>Backup - WAN is enabled only when other WAN ports specified in Backup For (see below), have lost connection.</p> <ul style="list-style-type: none"> <li>● Backup For - Select the WANs for which this WAN is intended to serve as a backup.</li> <li>● Active When - Set the condition for backup connection. <ul style="list-style-type: none"> <li>- Any - The selected WAN(s) will be activated when any master WAN interface disconnects.</li> <li>- All - All of the backup WANs will be activated only when all master WAN interface disconnects.</li> <li>- Fails to connect - When the active WAN failed, the WAN selected above will be activated as the main network connection.</li> <li>- Meet All/Any of the following conditions - When the upload traffic, download traffic, latency, jitter and/or packet loss of active WAN reaches the traffic threshold (specified here), the backup WAN will be enabled automatically to share the overloaded data traffic.</li> </ul> </li> </ul>

After finished the above settings, click OK to save the settings.

## II-1-2 Internet Access

For the router supports multi-WAN function, the users can set different WAN settings (for WAN1, WAN2, WAN3 or LTE, WAN4) for Internet Access. Due to different Physical Mode for WAN interface, the Access Mode for these connections also varies. Refer to the following figures for examples.

Access Mode for Ethernet,

WAN >> Internet Access

Internet Access					
Index	Display Name	Physical Mode	Access Mode	Details Page	IPv6
WAN1		Ethernet	Static or Dynamic IP	Details Page	IPv6
WAN2		Ethernet	Static or Dynamic IP	Details Page	IPv6
WAN3		Wireless 2.4G	None PPPoE	Details Page	IPv6
WAN4		Wireless 5G	Static or Dynamic IP PPTP/L2TP	Details Page	IPv6
WAN5		USB	None	Details Page	IPv6
WAN6		USB	None	Details Page	IPv6

Note:

1. Device on USB port 1 applies WAN5 configuration.
2. Device on USB port 2 applies WAN6 configuration.

DHCP Client Option

Access Mode for Wireless 2.4G/5G,

WAN >> Internet Access

Internet Access					
Index	Display Name	Physical Mode	Access Mode	Details Page	IPv6
WAN1		Ethernet	Static or Dynamic IP	Details Page	IPv6
WAN2		Ethernet	Static or Dynamic IP	Details Page	IPv6
WAN3		Wireless 2.4G	None	Details Page	IPv6
WAN4		Wireless 5G	None Static or Dynamic IP	Details Page	IPv6
LTE		USB	None	Details Page	IPv6
WAN6		USB	None	Details Page	IPv6

Note:

1. Device on USB port 2 applies WAN6 configuration.

DHCP Client Option

Access Mode for USB,

WAN >> Internet Access

Internet Access

Index	Display Name	Physical Mode	Access Mode	Details Page	IPv6
WAN1		Ethernet	Static or Dynamic IP	Details Page	IPv6
WAN2		Ethernet	Static or Dynamic IP	Details Page	IPv6
WAN3		Wireless 2.4G	None	Details Page	IPv6
WAN4		Wireless 5G	None	Details Page	IPv6
WAN5		USB	None	Details Page	IPv6
WAN6		USB	None	Details Page	IPv6

Note:

1. Device on USB port 1 applies WAN5 configuration
2. Device on USB port 2 applies WAN6 configuration.

DHCP Client Option

Available settings are explained as follows:

Item	Description
Index	Display the WAN interface.
Display Name	It shows the name of the WAN1/WAN2/WAN3/WAN4/WAN5 or LTE/WAN6 that entered in general setup.
Physical Mode	It shows the physical connection for WAN interfaces according to the real network connection.
Access Mode	Use the drop down list to choose a proper access mode. The details page of that mode will be popped up. If not, click Details Page for accessing the page to configure the settings.
Details Page	This button will open different web page (based on IPv4) according to the access mode that you choose in WAN interface. Note that Details Page will be changed slightly based on physical mode specified on WAN>>General Setup.
IPv6	This button will open different web page (based on Physical Mode) to setup IPv6 Internet Access Mode for WAN interface.
DHCP Client Option	This button allows you to configure DHCP client options. DHCP packets can be processed by adding option number and data information when such function is enabled and configured.

## DHCP Client Options Status

IPv4		IPv6		Set to Factory Default	
5 entries per page					
Options List					
Enable	Interface	Option	Type	Data	
Enable: <input checked="" type="checkbox"/>					
Interface: All <input type="checkbox"/> WAN1 <input type="checkbox"/> WAN2 <input type="checkbox"/> WAN3 <input type="checkbox"/> WAN4 <input type="checkbox"/> LTE <input type="checkbox"/> WAN6 <input type="checkbox"/> WAN7 <input type="checkbox"/> WAN8 <input type="checkbox"/> WAN9					
Option Number: <input type="text"/>					
DataType: <input checked="" type="radio"/> ASCII Character (EX: Option:18, Data:/path) <input type="radio"/> Hexadecimal Digit (Please check note 4.) <input type="radio"/> Address List (EX: Option:44, Data:172.16.2.10,172.16.2.20...)					
Data: <input type="text"/> (Max: 62 characters)					
<input type="button" value="Add"/>		<input type="button" value="Update"/>		<input type="button" value="Delete"/> <input type="button" value="Reset"/>	

## Note:

- Option 12 is reserved. You cannot configure it here, but you can configure it in "Router Name" field of "WAN >> Internet Access >> Details Page".
- Option 55 is reserved and configured with value 1, 3, 6, 15 and 212, also 33 and 121 for some models.
- Configuring option 61 here will override the setting in "WAN >> Internet Access" page's DHCP Client Identifier field.
- Hexadecimal Digit: Input the hexadecimal representation of ASCII Character data. EX: Option:18, Data:2f70617468 (/path)
- Address List: Data column supports maximum 239 characters or 15 IP addresses.

OK

**Enable/Disable** - Enable/Disable the function of DHCP Option. Each DHCP option is composed by an option number with data. For example,

Option number:100

Data: abcd

When such function is enabled, the specified values for DHCP option will be seen in DHCP reply packets.

**Interface** - Specify the WAN interface(s) that will be overwritten by such function. WAN7 ~ WAN9 can be located under WAN>>Multi-PVC/VLAN.

**Option Number** - Type a number for such function.

**DataType** - Choose the type (ASCII or Hex) for the data to be stored.

**Data** - Enter the content of the data to be processed by the function of DHCP option.



## Info

If you choose to configure option 61 here, the detailed settings in WAN>>Interface Access will be overwritten.

## II-1-2-1 Details Page for PPPoE in WAN1/WAN2 (Physical Mode: Ethernet)

To choose PPPoE as the accessing protocol of the Internet, please select PPPoE from the WAN>>Internet Access >>WAN1/2 page. The following web page will be shown.

WAN >> Internet Access

**WAN 1**

PPPoE	Static or Dynamic IP	PPTP/L2TP	IPv6
<input type="radio"/> Enable <input checked="" type="radio"/> Disable		<b>PPP/MP Setup</b> PPP Authentication: PAP/CHAP/MS-CHAP/MS-CHAPv2 ▾ Idle Timeout: -1 second(s)	
<b>ISP Access Setup</b> Service Name (Optional): <input type="text"/> (Max: 23 characters) Username: <input type="text"/> (Max: 63 characters) Password: <input type="text"/> (Max: 62 characters)		<b>IP Address Assignment Method (IPCP)</b> <input type="text"/> WAN IP Alias Fixed IP: <input type="radio"/> Yes <input checked="" type="radio"/> No (Dynamic IP) Fixed IP Address: <input type="text"/>	
Index(1-15) in <b>Schedule Setup</b> : => <input type="text"/> <input type="text"/> <input type="text"/> <input type="text"/>		<input checked="" type="radio"/> Default MAC Address <input type="radio"/> Specify a MAC Address MAC Address: <input type="text"/> <input type="text"/> <input type="text"/> <input type="text"/> <input type="text"/> <input type="text"/>	
<b>PPPoE Pass-through<sup>1</sup></b> <input type="checkbox"/> For Wired LAN <input type="checkbox"/> For Wireless LAN			
<b>WAN Connection Detection</b> Mode: <input type="text"/> PPP Detect ▾			
<b>MTU</b> <input type="text"/> 1500 (Max:1500) Path MTU Discovery: <input type="text"/> Detect			
<b>TTL</b> Change the TTL value: <input type="text"/> Enable ▾			

**Note:**

- (Optional) Required for some ISPs. Leave blank if in doubt because the connection request might be denied if "Service Name" is incorrect.
- VPN feature may be affected when the value of MTU is changed, please also check your value of VPN MSS in "[VPN and Remote Access >> PPP General Setup](#)" or "[VPN and Remote Access >> IPsec General Setup](#)" page. We recommend to put the same decreased value on VPN MSS. For example, reducing the MTU from 1500 -> 1400, then it will need to reduce 100 from MSS value.

OK  Cancel

Available settings are explained as follows:

Item	Description
Enable/Disable	Click Enable for activating this function. If you click Disable, this function will be closed and all the settings that you adjusted in this page will be invalid.
ISP Access Setup	Enter your allocated username, password and authentication parameters according to the information provided by your ISP.  Service Name (Optional) - Enter the description of the specific network service. Username - Enter the username provided by ISP in this field. The maximum length of the user name you can set is 63 characters. Password - Enter the password provided by ISP in this field. The maximum length of the password you can set is 62 characters. Index (1-15) in Schedule Setup - You can Enter four sets of time schedule for your request. All the schedules can be set previously in Applications >> Schedule web page and you

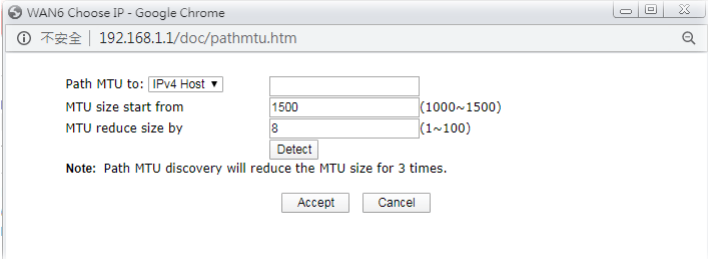
	can use the number that you have set in that web page.
PPPoE Pass-through	<p>The router offers PPPoE dial-up connection. Besides, you also can establish the PPPoE connection directly from local clients to your ISP via the Vigor router. When PPPoA protocol is selected, the PPPoE package transmitted by PC will be transformed into PPPoA package and sent to WAN server. Thus, the PC can access Internet through such direction.</p> <p>For Wired LAN - If you check this box, PCs on the same network can use another set of PPPoE session (different with the Host PC) to access into Internet.</p> <p>For Wireless LAN - It is available for <i>n</i> model. If you check this box, PCs on the same wireless network can use another set of PPPoE session (different with the Host PC) to access into Internet.</p> <p>Note: To have PPPoA Pass-through, please choose PPPoA protocol and check the box(es) here. The router will behave like a modem which only serves the PPPoE client on the LAN. That's, the router will offer PPPoA dial-up connection.</p>
WAN Connection Detection	<p>Such function allows you to verify whether network connection is alive or not through PPP Detect or Ping Detect. Mode - Choose PPP Detect or Ping Detect for the system to execute for WAN detection. If you choose Ping Detect as the detection mode, you have to type required settings for the following items.</p> <ul style="list-style-type: none"> <li>● Primary/Secondary Ping IP - If you choose Ping Detect as detection mode, you have to type Primary or Secondary IP address in this field for pinging.</li> <li>● Ping Gateway IP - If you choose Ping Detect as detection mode, you also can enable this setting to use current WAN gateway IP address for pinging.</li> <li>● With the IP address(es) pinging, Vigor router can check if the WAN connection is on or off.</li> <li>● TTL (Time to Live) - Set TTL value of PING operation.</li> <li>● Ping Interval - Enter the interval for the system to execute the PING operation.</li> <li>● Ping Retry - Enter the number of times that the system is allowed to execute the PING operation before WAN disconnection is judged.</li> </ul>
MTU	<p>It means Max Transmit Unit for packet.</p> <p>Path MTU Discovery - It is used to detect the maximum MTU size of a packet not to be segmented in specific transmit path.</p> <p>Click Detect to open the following dialog.</p>  <ul style="list-style-type: none"> <li>● Path MTU to - Enter the IP address as the specific transmit path.</li> <li>● MTU size start from - Determine the starting point value of the packet. Default setting is 1500.</li> <li>● MTU reduce size by - It determines the decreasing size</li> </ul>

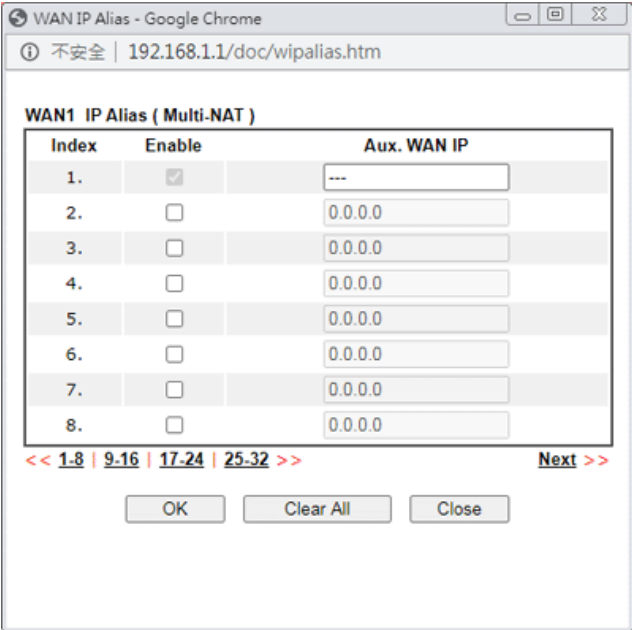

	<p>of MTU value. For example, the number specified in this field is “8”. The maximum MTU size is “1500”. After clicking the “detect” button, the system will calculate and get the suitable MTU value such as 1500, 1492, 1484 and etc., automatically.</p> <ul style="list-style-type: none"> <li>● Detect - Click it to detect a suitable MTU value</li> <li>● Accept - After clicking it, the detected value will be displayed in the field of MTU.</li> </ul>
TTL	<p>Change the TTL value - Enable or disable the TTL (Time to Live) for a packet transmitted through Vigor router.</p> <ul style="list-style-type: none"> <li>● Enable - TTL value will be reduced (-1) when it passes through Vigor router. It will cause the client, accessing Internet through Vigor router, be blocked by certain ISP when TTL value becomes “0”.</li> <li>● Disable - TTL value will not be reduced. Then, when a packet passes through Vigor router, it will not be cancelled. That is, the client who sends out the packet will not be blocked by ISP.</li> </ul>
PPP/MP Setup	<p>PPP Authentication - Select PAP only or PAP / CHAP / MS-CHAP / MS-CHAPv2 for PPP.</p> <p>Idle Timeout - Set the timeout for breaking down the Internet after passing through the time without any action.</p> <p>IP Address Assignment Method (IPCP)- Usually ISP dynamically assigns IP address to you each time you connect to it and request. In some case, your ISP provides service to always assign you the same IP address whenever you request. In this case, you can fill in this IP address in the Fixed IP field. Please contact your ISP before you want to use this function.</p> <p>WAN IP Alias - If you have multiple public IP addresses and would like to utilize them on the WAN interface, please use WAN IP Alias. You can set up to 32 public IP addresses other than the current one you are using. Enter the additional WAN IP address and check the Enable box. Then click OK to exit the dialog.</p>  <p>Fixed IP Address - Enter a fixed IP address.</p> <p>Default MAC Address - Enter MAC address for the router. You</p>

can use Default MAC Address or specify another MAC address for your necessity.  
Specify a MAC Address - Enter the MAC address for the router manually.

After finishing all the settings here, please click OK to activate them.

## II-1-2-2 Details Page for Static or Dynamic IP in WAN1/WAN2 (Physical Mode: Ethernet)

For static IP mode, you usually receive a fixed public IP address or a public subnet, namely multiple public IP addresses from your DSL or Cable ISP service providers. In most cases, a Cable service provider will offer a fixed public IP, while a DSL service provider will offer a public subnet. If you have a public subnet, you could assign an IP address or many IP address to the WAN interface.

To use Static or Dynamic IP as the accessing protocol of the internet, please click the Static or Dynamic IP tab. The following web page will be shown.

WAN >> Internet Access

**WAN 1**

PPPoE	Static or Dynamic IP	PPTP/L2TP	IPv6
<input checked="" type="radio"/> Enable <input type="radio"/> Disable			
<b>Keep WAN Connection</b> <input type="checkbox"/> Enable PING to keep alive PING to the IP: <input type="text"/> PING Interval: <input type="text"/> minute(s)			
<b>WAN Connection Detection</b> Mode: <input type="text" value="ARP Detect"/>			
<b>MTU</b> <input type="text" value="1500"/> (Max:1500) Path MTU Discovery: <input type="text" value="Detect"/>			
<b>RIP Protocol</b> <input type="checkbox"/> Enable RIP			
<b>Bridge Mode</b> <input type="checkbox"/> Enable Bridge Mode <input type="checkbox"/> Enable Full Bridge Mode Bridge Subnet: <input type="text" value="LAN 1"/>			
<b>TTL</b> Change the TTL value: <input type="text" value="Enable"/>			
<b>WAN IP Network Settings</b> <input type="text" value="WAN IP Alias"/>			
<input checked="" type="radio"/> Obtain an IP address automatically			
Router Name: <input type="text" value="Vigor"/>		Domain Name: <input type="text" value="Max: 39 characters"/>	
<input type="checkbox"/> DHCP Client Identifier *			
Username: <input type="text"/>		Password: <input type="text"/>	
<input type="radio"/> Specify an IP address			
IP Address: <input type="text" value="192.168.124.14"/>		Subnet Mask: <input type="text" value="255.255.255.0"/>	
Gateway IP Address: <input type="text" value="192.168.124.1"/>			
<input checked="" type="radio"/> Default MAC Address <input type="radio"/> Specify a MAC Address MAC Address: <input type="text" value="14"/> · <input type="text" value="49"/> · <input type="text" value="BC"/> : <input type="text" value="02"/> · <input type="text" value="37"/> · <input type="text" value="E9"/>			
<b>DNS Server IP Address</b> Primary IP Address: <input type="text" value="8.8.8.8"/> Secondary IP Address: <input type="text" value="8.8.4.4"/>			

\*: Required for some ISPs

**Note:**

1. If enable firewall in bridge mode, IPv6 connection type would be change to DHCPv6 mode.
2. Bridge Subnet cannot be selected by Multi-WAN Interface at the same time.
3. If both Bridge Mode and Firewall are enabled, the settings under User Management will be ignored.
4. Full Bridge Mode supports forwarding packets with VLAN tags.
5. Full Bridge Mode doesn't support wireless LAN.

Available settings are explained as follows:

Item	Description
Enable / Disable	Click Enable for activating this function. If you click Disable, this function will be closed and all the settings that you adjusted in this page will be invalid.

Keep WAN Connection	<p>Normally, this function is designed for Dynamic IP environments because some ISPs will drop connections if there is no traffic within certain periods of time. Check Enable PING to keep alive box to activate this function.</p> <p>PING to the IP - If you enable the PING function, please specify the IP address for the system to PING it for keeping alive.</p> <p>PING Interval - Enter the interval for the system to execute the PING operation.</p>
WAN Connection Detection	<p>Such function allows you to verify whether network connection is alive or not through ARP Detect or Ping Detect.</p> <p>Mode - Choose ARP Detect, Ping Detect or Always On for the system to execute for WAN detection. If you choose Ping Detect as the detection mode, you have to type required settings for the following items.</p> <ul style="list-style-type: none"> <li>● Primary/Secondary Ping IP - If you choose Ping Detect as detection mode, you have to type Primary or Secondary IP address in this field for pinging.</li> <li>● Ping Gateway IP - If you choose Ping Detect as detection mode, you also can enable this setting to use current WAN gateway IP address for pinging. With the IP address(es) pinging, Vigor router can check if the WAN connection is on or off.</li> <li>● TTL (Time to Live) - Set TTL value of PING operation.</li> <li>● Ping Interval - Enter the interval for the system to execute the PING operation.</li> <li>● Ping Retry - Enter the number of times that the system is allowed to execute the PING operation before WAN disconnection is judged.</li> </ul>
MTU	<p>It means Max Transmit Unit for packet.</p> <p>Path MTU Discovery - It is used to detect the maximum MTU size of a packet not to be segmented in specific transmit path.</p> <p>Click Detect to open the following dialog.</p>  <ul style="list-style-type: none"> <li>● Path MTU to - Enter the IP address as the specific transmit path.</li> <li>● MTU size start from - Determine the starting point value of the packet. Default setting is 1500.</li> <li>● MTU reduce size by - It determines the decreasing size of MTU value. For example, the number specified in this field is “8”. The maximum MTU size is “1500”. After clicking the “detect” button, the system will calculate and get the suitable MTU value such as 1500, 1492, 1484 and etc., automatically.</li> </ul>

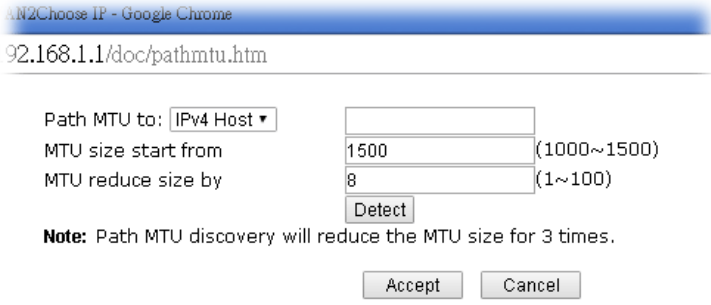
	<ul style="list-style-type: none"> <li>● Detect - Click it to detect a suitable MTU value</li> <li>● Accept - After clicking it, the detected value will be displayed in the field of MTU.</li> </ul>
RIP Protocol	Routing Information Protocol is abbreviated as RIP (RFC1058) specifying how routers exchange routing tables information. Click Enable RIP for activating this function.
Bridge Mode	<p>Enable Full Bridge Mode - If the function is enabled, the router will work as a bridge modem which is able to forward incoming packets with VLAN tags.</p> <p>Enable Bridge Mode - If the function is enabled, the router will work as a bridge modem. Yet, the incoming packets with VLAN tags will be discarded.</p> <p>Enable Firewall - It is available when Bridge Mode is enabled. When both Bridge Mode and Firewall check boxes are enabled, the settings configured (user profiles) under User Management will be ignored. And all of the filter rules defined and enabled in Firewall menu will be activated.</p> <p>Bridge Subnet - Make a bridge between the selected LAN subnet and such WAN interface.</p>
TTL	<p>Change the TTL value - Enable or disable the TTL (Time to Live) for a packet transmitted through Vigor router.</p> <ul style="list-style-type: none"> <li>● If enabled - TTL value will be reduced (-1) when it passes through Vigor router. It will cause the client, accessing Internet through Vigor router, to be blocked by certain ISP when TTL value becomes "0".</li> <li>● If disabled - TTL value will not be reduced. Then, when a packet passes through Vigor router, it will not be cancelled. That is, the client who sends out the packet will not be blocked by ISP.</li> </ul>
WAN IP Network Settings	<p>This group allows you to obtain an IP address automatically and allows you to enter IP address manually.</p> <p>WAN IP Alias - If you have multiple public IP addresses and would like to utilize them on the WAN interface, please use WAN IP Alias. You can set up to 32 public IP addresses other than the current one you are using.</p> <p>Obtain an IP address automatically - Click this button to obtain the IP address automatically if you want to use Dynamic IP mode.</p> <ul style="list-style-type: none"> <li>● Router Name: Enter the router name provided by ISP.</li> <li>● Domain Name: Enter the domain name that you have assigned.</li> </ul> <p>DHCP Client Identifier: Check the box to specify username and password as the DHCP client identifier for some ISP.</p> <ul style="list-style-type: none"> <li>● Username: Type a name as username. The maximum length of the user name you can set is 63 characters.</li> <li>● Password: Type a password. The maximum length of the password you can set is 62 characters.</li> </ul> <p>Specify an IP address - Click this radio button to specify some data if you want to use Static IP mode.</p> <ul style="list-style-type: none"> <li>● IP Address: Enter the IP address.</li> <li>● Subnet Mask: Enter the subnet mask.</li> <li>● Gateway IP Address: Enter the gateway IP address.</li> </ul> <p>Default MAC Address: Click this radio button to use default</p>

	MAC address for the router. Specify a MAC Address: Some Cable service providers specify a specific MAC address for access authentication. In such cases you need to click the Specify a MAC Address and enter the MAC address in the MAC Address field.
DNS Server IP Address	Enter the primary IP address for the router if you want to use Static IP mode. If necessary, Enter secondary IP address for necessity in the future.

After finishing all the settings here, please click OK to activate them.

### II-1-2-3 Details Page for PPTP/L2TP in WAN1/WAN2 (Physical Mode: Ethernet)

To use PPTP/L2TP as the accessing protocol of the internet, please click the PPTP/L2TP tab. The following web page will be shown.

WAN >> Internet Access

**WAN 1**

PPPoE	Static or Dynamic IP	PPTP/L2TP	IPv6
<input type="radio"/> Enable PPTP <input type="radio"/> Enable L2TP <input checked="" type="radio"/> Disable Server Address <input type="text" value="Max: 63 characters"/> Specify Gateway IP Address <input type="text" value="192.168.124.1"/>		<b>PPP Setup</b> PPP Authentication <input type="text" value="PAP/CHAP/MS-CHAP/MS-CHAPv2"/> Idle Timeout <input type="text" value="-1"/> second(s) <b>IP Address Assignment Method (IPCP)</b> <input type="text" value="WAN IP Alias"/> Fixed IP: <input type="radio"/> Yes <input checked="" type="radio"/> No (Dynamic IP) Fixed IP Address <input type="text"/> <b>WAN IP Network Settings</b> <input checked="" type="radio"/> Obtain an IP address automatically <input type="radio"/> Specify an IP address IP Address <input type="text" value="192.168.124.14"/> Subnet Mask <input type="text" value="255.255.255.0"/>	
<b>ISP Access Setup</b> Username <input type="text"/> Password <input type="text"/> Index(1-15) in <b>Schedule</b> Setup: => <input type="text"/> , <input type="text"/> , <input type="text"/> , <input type="text"/>			
MTU <input type="text" value="1460"/> (Max:1460) Path MTU Discovery <input type="text" value="Detect"/>			

Available settings are explained as follows:

Item	Description
PPTP/L2TP	Enable PPTP - Click this radio button to enable a PPTP client to establish a tunnel to a DSL modem on the WAN interface. Enable L2TP - Click this radio button to enable a L2TP client to establish a tunnel to a DSL modem on the WAN interface. Disable - Click this radio button to close the connection through PPTP or L2TP. Server Address - Specify the IP address of the PPTP/L2TP server if you enable PPTP/L2TP client mode. Specify Gateway IP Address - Specify the gateway IP address for DHCP server.
ISP Access Setup	Username - Enter the username provided by ISP in this field. The maximum length of the user name you can set is 63 characters. Password - Enter the password provided by ISP in this field. The maximum length of the password you can set is 62 characters. Index(1-15) in Schedule Setup - You can Enter four sets of time schedule for your request. All the schedules can be set previously in Applications >> Schedule web page and you can use the number that you have set in that web page.
MTU	It means Max Transmit Unit for packet. Path MTU Discovery - It is used to detect the maximum MTU size of a packet not to be segmented in specific transmit path. Click Detect to open the following dialog.

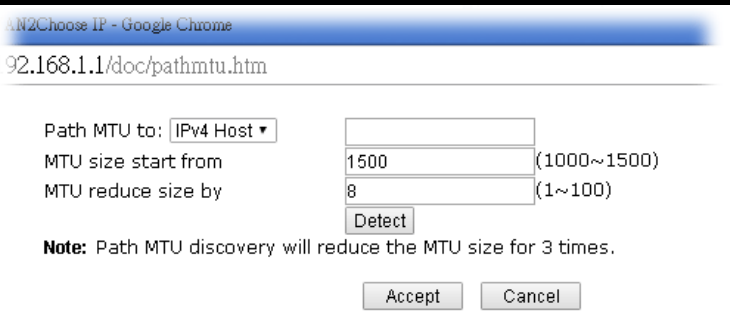
	 <ul style="list-style-type: none"> <li>● Path MTU to - Enter the IP address as the specific transmit path.</li> <li>● MTU size start from - Determine the starting point value of the packet. Default setting is 1500.</li> <li>● MTU reduce size by- It determines the decreasing size of MTU value. For example, the number specified in this field is “8”. The maximum MTU size is “1500”. After clicking the “detect” button, the system will calculate and get the suitable MTU value such as 1500, 1492, 1484 and etc., automatically.</li> <li>● Detect - Click it to detect a suitable MTU value</li> <li>● Accept - After clicking it, the detected value will be displayed in the field of MTU.</li> </ul>
PPP/MP Setup	<p>PPP Authentication - Select PAP only or PAP / CHAP / MS-CHAP / MS-CHAPv2 for PPP.</p> <p>Idle Timeout - Set the timeout for breaking down the Internet after passing through the time without any action.</p> <p>IP Address Assignment Method (IPCP)- Usually ISP dynamically assigns IP address to you each time you connect to it and request. In some case, your ISP provides service to always assign you the same IP address whenever you request. In this case, you can fill in this IP address in the Fixed IP field. Please contact your ISP before you want to use this function.</p> <p>WAN IP Alias - If you have multiple public IP addresses and would like to utilize them on the WAN interface, please use WAN IP Alias. You can set up to 32 public IP addresses other than the current one you are using. Enter the additional WAN IP address and check the Enable box. Then click OK to exit the dialog.</p>

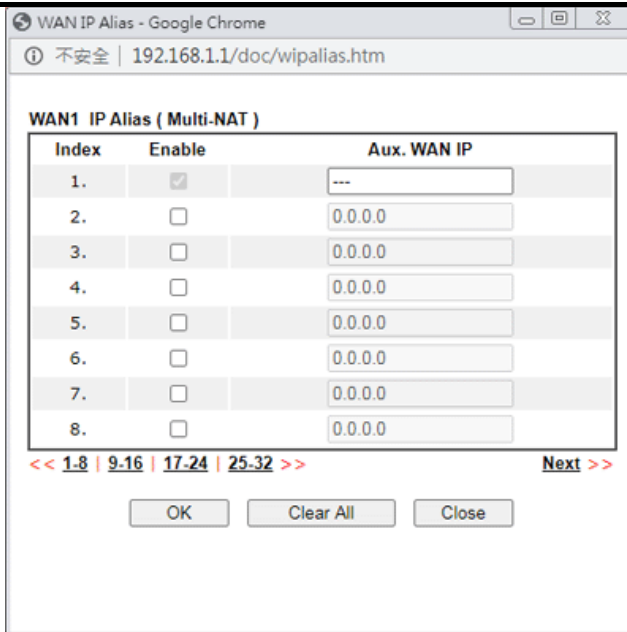

Fixed IP Address - Enter a fixed IP address.

**WAN IP Network Settings**

Obtain an IP address automatically - Click this button to obtain the IP address automatically.

Specify an IP address - Click this radio button to specify some data.

- IP Address - Enter the IP address.
- Subnet Mask - Enter the subnet mask.

After finishing all the settings here, please click OK to activate them.



## II-1-2-4 Details Page for WAN3/WAN4 (Physical Mode: Wireless 2.4G/ Wireless 5G)

When Wireless 2.4G is selected as Physical Mode, WAN uses wireless station mode to access Internet. The Router acts as a 2.4GHz wireless station and connects to the specific Wireless AP.



**Info** WAN3/WAN4 (Wireless WAN) is not available for "ax" model.

Open WAN>>Internet Access>>WAN3/4 page. The following web page will be shown.

WAN >> Internet Access

**WAN 3**

**Static or Dynamic IP**  
 Enable  Disable

---

Obtain an IP address automatically  
 Specify an IP address

IP Address   
 Subnet Mask   
 Gateway IP Address

---

**WAN Connection Detection**  
 Mode

---

**MTU**  (Max: 1500)

---

**Universal Repeater Parameters**

SSID    
 MAC Address (Optional)   
 Channel :   
 Security Mode   
 Encryption Mode   
 Pre-Shared Key(PSK)

Note: If Channel is modified, the Channel setting of wireless 2.4G would be also modified.

Available settings are explained as follows:

Item	Description
Enable/Disable	Click Enable for activating this function. If you click Disable, this function will be closed and all the settings that you adjusted in this page will be invalid.
Obtain an IP address automatically	Click this radio button to obtain the IP address automatically if you want to use Dynamic IP mode.
Specify an IP address	Click this radio button to specify some data if you want to use Static IP mode. IP address - Enter the IP address. Subnet Mask - Enter the subnet mask. Gateway IP Address - Enter the gateway IP address.
WAN Connection Detection	Such function allows you to verify whether network connection is alive or not through ARP Detect or Ping Detect.

	<p>Mode - Choose ARP Detect, Ping Detect or Always On for the system to execute for WAN detection. If you choose Ping Detect as the detection mode, you have to type required settings for the following items.</p> <ul style="list-style-type: none"> <li>● Ping IP - If you choose Ping Detect as detection mode, you also can enable this setting to use current WAN gateway IP address for ping. With the IP address(es) ping, Vigor router can check if the WAN connection is on or off.</li> <li>● TTL (Time to Live) - Set TTL value of PING operation.</li> </ul>																																																												
<p>MTU</p>	<p>It means Max Transmit Unit for packet.</p>																																																												
<p>Universal Repeater Parameters</p>	<p>AP Discovery - Click this button to open the Access Point Discovery window. Let wireless 2.4GHz do AP discovery and choose the Wireless AP you want to connect to.</p> <p>Wireless LAN &gt;&gt; Access Point Discovery</p> <hr/> <p>Access Point List</p> <table border="1"> <thead> <tr> <th>Index</th> <th>BSSID</th> <th>Channel</th> <th>RSSI</th> <th>SSID</th> <th>Authentication</th> </tr> </thead> <tbody> <tr> <td>1</td> <td>02:1D:AA:9F:E9:48</td> <td>11</td> <td>78%</td> <td>DrayTek-LAN-B</td> <td>Mixed(WPA+WPA2)/PSK</td> </tr> <tr> <td>2</td> <td>00:1D:AA:9F:E9:48</td> <td>11</td> <td>78%</td> <td>AP900-airtime</td> <td>WPA2/PSK</td> </tr> <tr> <td>3</td> <td>02:1D:AA:90:20:80</td> <td>11</td> <td>26%</td> <td>ap902_2.4G_114_2</td> <td>WPA2/PSK</td> </tr> <tr> <td>4</td> <td>00:1D:AA:90:20:80</td> <td>11</td> <td>26%</td> <td>ap902_Wifi_114_1</td> <td>WPA2/PSK</td> </tr> <tr> <td>5</td> <td>02:50:7F:22:33:88</td> <td>11</td> <td>23%</td> <td>AP900_110_Bandstee...</td> <td>WPA2/PSK</td> </tr> <tr> <td>6</td> <td>00:50:7F:22:33:88</td> <td>11</td> <td>23%</td> <td>AP900_110_2.4G-1</td> <td>WPA2/PSK</td> </tr> <tr> <td>7</td> <td>02:1D:AA:7E:41:80</td> <td>11</td> <td>13%</td> <td>TestRoaming2.4G-B</td> <td>Mixed(WPA+WPA2)/PSK</td> </tr> <tr> <td>8</td> <td>00:1D:AA:7E:41:80</td> <td>11</td> <td>18%</td> <td>TestRoaming2.4G-A</td> <td>Mixed(WPA+WPA2)/PSK</td> </tr> <tr> <td>9</td> <td>00:1D:AA:DD:75:00</td> <td>11</td> <td>63%</td> <td>v2860_lte_1</td> <td>Mixed(WPA+WPA2)/PSK</td> </tr> </tbody> </table> <p style="text-align: center;">Scan</p> <p>AP's MAC address <input type="text" value=" : : : : : :"/>  <input type="button" value="Add to"/> <input checked="" type="radio"/> Universal Repeater</p> <p>Note:</p> <ol style="list-style-type: none"> <li>1. During the scanning process (~5 seconds), no station is allowed to connect with the router.</li> <li>2. AP Discovery can only support up to 32 APs displayed on the screen.</li> </ol> <p>SSID - The identification of the Wireless AP.</p> <p>MAC Address (Optional)- The MAC Address of the Wireless AP.</p> <p>Channel - The channel of frequency of the Wireless AP.</p> <p>Security Mode - The mode to connect to the Wireless AP.</p> <ul style="list-style-type: none"> <li>● Disable - The Router connects to the wireless AP without any encryption mechanism.</li> <li>● WEP - The Router connects to the wireless AP as a WEP client and the encryption key should be entered in WEP Key. <ul style="list-style-type: none"> <li>- 64-Bit - For 64 bits WEP key, either 5 ASCII characters, such as 12345 (or 10 hexadecimal digitals leading by 0x, such as 0x4142434445.)</li> <li>- 128-Bit - For 128 bits WEP key, either 13 ASCII characters, such as ABCDEFGHIJKLM (or 26 hexadecimal digits leading by 0x, such as 0x4142434445464748494A4B4C4D).</li> <li>- WEP keys - Four keys can be entered here, but only one key can be selected at a time. The keys can be entered in ASCII or Hexadecimal. Check the key you wish to use.</li> </ul> </li> <li>● WPA/PSK - The Router connects to the wireless AP as a WPA client and the encryption key should be entered in PSK.</li> <li>● WPA2/PSK - The Router connects to the wireless AP as a WPA2 client and the encryption key should be entered in PSK. <ul style="list-style-type: none"> <li>- Encryption Mode - WPA/PSK uses TKIP as</li> </ul> </li> </ul>	Index	BSSID	Channel	RSSI	SSID	Authentication	1	02:1D:AA:9F:E9:48	11	78%	DrayTek-LAN-B	Mixed(WPA+WPA2)/PSK	2	00:1D:AA:9F:E9:48	11	78%	AP900-airtime	WPA2/PSK	3	02:1D:AA:90:20:80	11	26%	ap902_2.4G_114_2	WPA2/PSK	4	00:1D:AA:90:20:80	11	26%	ap902_Wifi_114_1	WPA2/PSK	5	02:50:7F:22:33:88	11	23%	AP900_110_Bandstee...	WPA2/PSK	6	00:50:7F:22:33:88	11	23%	AP900_110_2.4G-1	WPA2/PSK	7	02:1D:AA:7E:41:80	11	13%	TestRoaming2.4G-B	Mixed(WPA+WPA2)/PSK	8	00:1D:AA:7E:41:80	11	18%	TestRoaming2.4G-A	Mixed(WPA+WPA2)/PSK	9	00:1D:AA:DD:75:00	11	63%	v2860_lte_1	Mixed(WPA+WPA2)/PSK
Index	BSSID	Channel	RSSI	SSID	Authentication																																																								
1	02:1D:AA:9F:E9:48	11	78%	DrayTek-LAN-B	Mixed(WPA+WPA2)/PSK																																																								
2	00:1D:AA:9F:E9:48	11	78%	AP900-airtime	WPA2/PSK																																																								
3	02:1D:AA:90:20:80	11	26%	ap902_2.4G_114_2	WPA2/PSK																																																								
4	00:1D:AA:90:20:80	11	26%	ap902_Wifi_114_1	WPA2/PSK																																																								
5	02:50:7F:22:33:88	11	23%	AP900_110_Bandstee...	WPA2/PSK																																																								
6	00:50:7F:22:33:88	11	23%	AP900_110_2.4G-1	WPA2/PSK																																																								
7	02:1D:AA:7E:41:80	11	13%	TestRoaming2.4G-B	Mixed(WPA+WPA2)/PSK																																																								
8	00:1D:AA:7E:41:80	11	18%	TestRoaming2.4G-A	Mixed(WPA+WPA2)/PSK																																																								
9	00:1D:AA:DD:75:00	11	63%	v2860_lte_1	Mixed(WPA+WPA2)/PSK																																																								

	<p>Encryption Mode. WPA2/PSK uses AES as Encryption Mode.</p> <ul style="list-style-type: none"> <li>- Pre-Shared Key (PSK) - The PSK. Either 8-63 ASCII characters, such as 012345678..(or 64 Hexadecimal digits leading by 0x, such as "0x321253abcde...").</li> </ul>
--	--

After finishing all the settings here, please click OK to activate them.

### II-1-2-5 Details Page for 3G/4G USB Modem (PPP mode) in WAN5 / WAN6

To use 3G/4G USB Modem (PPP mode) as the accessing protocol of the internet, please choose Internet Access from WAN menu. Then, select 3G/4G USB Modem (PPP mode) for WAN5/WAN6. The following web page will be shown.

WAN >> Internet Access ?

---

**WAN 6**

3G/4G USB Modem(PPP mode) | 3G/4G USB Modem(DHCP mode) | IPv6 | [Modem Support List](#)

**3G/4G USB Modem(PPP mode)**  Enable  Disable

SIM PIN code

Modem Initial String   
(Default:AT&FE0V1X1&D2&C1S0=0)

APN Name  Apply

Modem Initial String2

Modem Dial String   
(Default:ATDT\*99#, CDMA:ATDT#777, TD-SCDMA:ATDT\*98\*1#)

Service Name  (Optional)

PPP Username  (Optional)

PPP Password  (Optional)

PPP Authentication

Index(1-15) in [Schedule Setup](#):  
=>  ,  ,  ,

---

**WAN Connection Detection**

Mode

Available settings are explained as follows:

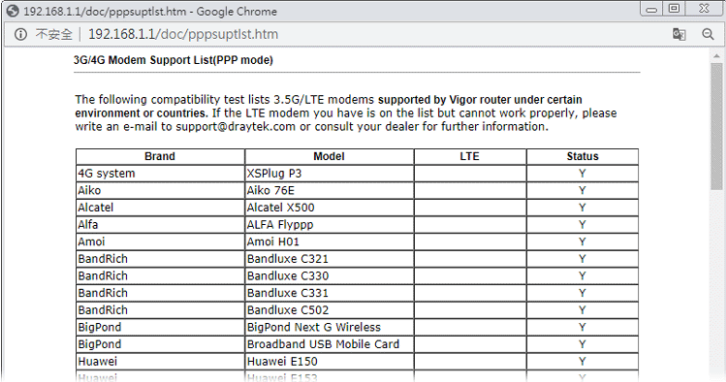
Item	Description																																																								
Modem Support List	<p>It lists all of the modems supported by such router.</p>  <table border="1" style="width: 100%; border-collapse: collapse;"> <thead> <tr> <th>Brand</th> <th>Model</th> <th>LTE</th> <th>Status</th> </tr> </thead> <tbody> <tr><td>4G system</td><td>XSPUG P3</td><td></td><td>Y</td></tr> <tr><td>Aiko</td><td>Aiko 76E</td><td></td><td>Y</td></tr> <tr><td>Alcatel</td><td>Alcatel X500</td><td></td><td>Y</td></tr> <tr><td>Alfa</td><td>ALFA Flyppp</td><td></td><td>Y</td></tr> <tr><td>Amoi</td><td>Amoi H01</td><td></td><td>Y</td></tr> <tr><td>BandRich</td><td>Bandlux C321</td><td></td><td>Y</td></tr> <tr><td>BandRich</td><td>Bandlux C330</td><td></td><td>Y</td></tr> <tr><td>BandRich</td><td>Bandlux C331</td><td></td><td>Y</td></tr> <tr><td>BandRich</td><td>Bandlux C502</td><td></td><td>Y</td></tr> <tr><td>BigPond</td><td>BigPond Next G Wireless</td><td></td><td>Y</td></tr> <tr><td>BigPond</td><td>Broadband USB Mobile Card</td><td></td><td>Y</td></tr> <tr><td>Huawei</td><td>Huawei E150</td><td></td><td>Y</td></tr> <tr><td>Huawei</td><td>Huawei E183</td><td></td><td>Y</td></tr> </tbody> </table>	Brand	Model	LTE	Status	4G system	XSPUG P3		Y	Aiko	Aiko 76E		Y	Alcatel	Alcatel X500		Y	Alfa	ALFA Flyppp		Y	Amoi	Amoi H01		Y	BandRich	Bandlux C321		Y	BandRich	Bandlux C330		Y	BandRich	Bandlux C331		Y	BandRich	Bandlux C502		Y	BigPond	BigPond Next G Wireless		Y	BigPond	Broadband USB Mobile Card		Y	Huawei	Huawei E150		Y	Huawei	Huawei E183		Y
Brand	Model	LTE	Status																																																						
4G system	XSPUG P3		Y																																																						
Aiko	Aiko 76E		Y																																																						
Alcatel	Alcatel X500		Y																																																						
Alfa	ALFA Flyppp		Y																																																						
Amoi	Amoi H01		Y																																																						
BandRich	Bandlux C321		Y																																																						
BandRich	Bandlux C330		Y																																																						
BandRich	Bandlux C331		Y																																																						
BandRich	Bandlux C502		Y																																																						
BigPond	BigPond Next G Wireless		Y																																																						
BigPond	Broadband USB Mobile Card		Y																																																						
Huawei	Huawei E150		Y																																																						
Huawei	Huawei E183		Y																																																						
3G /4G USB Modem (PPP)	Click Enable for activating this function. If you click Disable,																																																								

mode)	this function will be closed and all the settings that you adjusted in this page will be invalid.
SIM PIN code	Type PIN code of the SIM card that will be used to access Internet. The maximum length of the PIN code you can set is 15 characters.
Modem Initial String	Such value is used to initialize USB modem. Please use the default value. If you have any question, please contact to your ISP. The maximum length of the string you can set is 47 characters.
APN Name	APN means Access Point Name which is provided and required by some ISPs. Enter the name and click Apply. The maximum length of the name you can set is 43 characters.
Modem Initial String2	The initial string 1 is shared with APN. In some cases, user may need another initial AT command to restrict 3G band or do any special settings. The maximum length of the string you can set is 47 characters.
Modem Dial String	Such value is used to dial through USB mode. Please use the default value. If you have any question, please contact to your ISP. The maximum length of the string you can set is 31 characters.
Service Name	Enter the description of the specific network service.
PPP Username	Enter the PPP username (optional). The maximum length of the name you can set is 63 characters.
PPP Password	Enter the PPP password (optional). The maximum length of the password you can set is 62 characters.
PPP Authentication	Select PAP only or PAP or CHAP for PPP.
Index (1-15) in Schedule Setup	Set the wireless LAN to work at certain time interval only. You may choose up to 4 schedules out of the 15 schedules pre-defined in Applications >> Schedule setup. The default setting of this field is blank and the function will always work.
WAN Connection Detection	Such function allows you to verify whether network connection is alive or not through PPP Detect or Ping Detect. Mode - Choose PPP Detect or Ping Detect for the system to execute for WAN detection. If you choose Ping Detect as the detection mode, you have to type required settings for the following items. <ul style="list-style-type: none"> <li>● Primary/Secondary Ping IP - If you choose Ping Detect as detection mode, you have to type Primary or Secondary IP address in this field for ping.</li> <li>● Ping Gateway IP - If you choose Ping Detect as detection mode, you also can enable this setting to use current WAN gateway IP address for ping. With the IP address(es) ping, Vigor router can check if the WAN connection is on or off.</li> <li>● TTL (Time to Live) - Set TTL value of PING operation.</li> </ul>

- Ping Interval - Enter the interval for the system to execute the PING operation.
- Ping Retry - Enter the number of times that the system is allowed to execute the PING operation before WAN disconnection is judged.

After finishing all the settings here, please click OK to activate them.

## II-1-2-6 Details Page for 3G/4G USB Modem (DHCP mode) in WAN5 / WAN6

To use 3G/4G USB Modem (DHCP mode) as the accessing protocol of the internet, please choose Internet Access from WAN menu. Then, select 3G/4G USB Modem (DHCP mode) for WAN5/WAN6. The following web page will be shown.

WAN >> Internet Access ?

---

WAN 5

3G/4G USB Modem(PPP mode)
  3G/4G USB Modem(DHCP mode)
  IPv6
 [Modem Support List](#)

Enable
  Disable

SIM PIN code

Network Mode  (Default:4G/3G/2G)

APN Name 
  
 Disable Auto APN

LTE software version ---  
 LTE hardware version ---

**WAN Connection Detection**  
 Mode

**Schedule Profile:**  
 =>   
 =>  =>

MTU  (Default:1500)  
 Path MTU Discovery

Authentication

Username  (Optional)

Password  (Optional)

**Note:**

- Please note that in some case USB port connection will be terminated temporarily to activate the new configuration.
- VPN feature may be affected when the value of MTU is changed, please also check your value of VPN MSS in "[VPN and Remote Access >> PPP General Setup](#)" or "[VPN and Remote Access >> IPsec General Setup](#)" page.  
We recommend to put the same decreased value on VPN MSS. For example, reducing the MTU from 1500 -> 1400, then it will need to reduce 100 from MSS value.

Available settings are explained as follows:

Item	Description
Modem Support List	It lists all of the modems supported by such router.

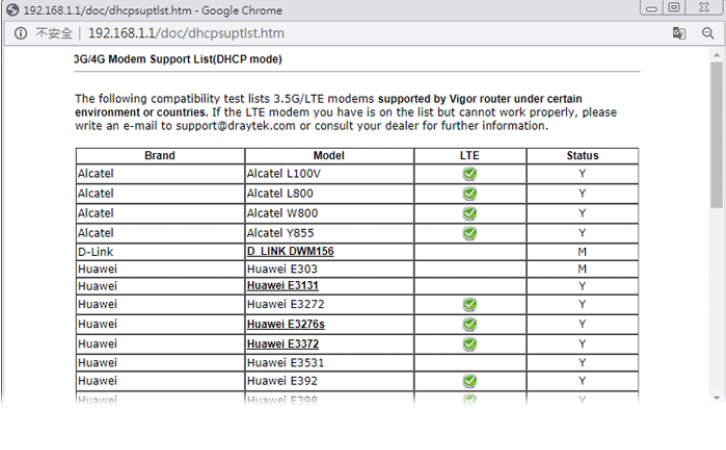
	 <p>The following compatibility test lists 3.5G/LTE modems supported by Vigor router under certain environment or countries. If the LTE modem you have is on the list but cannot work properly, please write an e-mail to support@draytek.com or consult your dealer for further information.</p> <table border="1"> <thead> <tr> <th>Brand</th> <th>Model</th> <th>LTE</th> <th>Status</th> </tr> </thead> <tbody> <tr><td>Alcatel</td><td>Alcatel L100v</td><td>✓</td><td>Y</td></tr> <tr><td>Alcatel</td><td>Alcatel L800</td><td>✓</td><td>Y</td></tr> <tr><td>Alcatel</td><td>Alcatel W800</td><td>✓</td><td>Y</td></tr> <tr><td>Alcatel</td><td>Alcatel Y855</td><td>✓</td><td>Y</td></tr> <tr><td>D-Link</td><td>D_LINK DWM156</td><td></td><td>M</td></tr> <tr><td>Huawei</td><td>Huawei E303</td><td></td><td>M</td></tr> <tr><td>Huawei</td><td>Huawei E3131</td><td></td><td>Y</td></tr> <tr><td>Huawei</td><td>Huawei E3272</td><td>✓</td><td>Y</td></tr> <tr><td>Huawei</td><td>Huawei E3276s</td><td>✓</td><td>Y</td></tr> <tr><td>Huawei</td><td>Huawei E3372</td><td>✓</td><td>Y</td></tr> <tr><td>Huawei</td><td>Huawei E3531</td><td>✓</td><td>Y</td></tr> <tr><td>Huawei</td><td>Huawei E392</td><td>✓</td><td>Y</td></tr> <tr><td>Huawei</td><td>Huawei E398</td><td>✓</td><td>Y</td></tr> </tbody> </table>	Brand	Model	LTE	Status	Alcatel	Alcatel L100v	✓	Y	Alcatel	Alcatel L800	✓	Y	Alcatel	Alcatel W800	✓	Y	Alcatel	Alcatel Y855	✓	Y	D-Link	D_LINK DWM156		M	Huawei	Huawei E303		M	Huawei	Huawei E3131		Y	Huawei	Huawei E3272	✓	Y	Huawei	Huawei E3276s	✓	Y	Huawei	Huawei E3372	✓	Y	Huawei	Huawei E3531	✓	Y	Huawei	Huawei E392	✓	Y	Huawei	Huawei E398	✓	Y
Brand	Model	LTE	Status																																																						
Alcatel	Alcatel L100v	✓	Y																																																						
Alcatel	Alcatel L800	✓	Y																																																						
Alcatel	Alcatel W800	✓	Y																																																						
Alcatel	Alcatel Y855	✓	Y																																																						
D-Link	D_LINK DWM156		M																																																						
Huawei	Huawei E303		M																																																						
Huawei	Huawei E3131		Y																																																						
Huawei	Huawei E3272	✓	Y																																																						
Huawei	Huawei E3276s	✓	Y																																																						
Huawei	Huawei E3372	✓	Y																																																						
Huawei	Huawei E3531	✓	Y																																																						
Huawei	Huawei E392	✓	Y																																																						
Huawei	Huawei E398	✓	Y																																																						
Enable / Disable	Click Enable for activating this function. If you click Disable, this function will be closed and all the settings that you adjusted in this page will be invalid.																																																								
SIM PIN code	Type PIN code of the SIM card that will be used to access Internet. The maximum length of the PIN code you can set is 19 characters.																																																								
Network Mode	Force Vigor router to connect Internet with the mode specified here. If you choose 4G/3G/2G as network mode, the router will choose a suitable one according to the actual wireless signal automatically.																																																								
APN Name	APN means Access Point Name which is provided and required by some ISPs. Enter the name and click Apply. The maximum length of the name you can set is 47 characters. Disable Auto APN - In default, the APN name will be given automatically (through pre-configured APN profile list) by Vigor router system. To specify an APN name, check this box and enter the APN name manually in the field of APN Name.																																																								
WAN Connection Detection	Such function allows you to verify whether network connection is alive or not through ARP Detect, Strict ARP Detect or Ping Detect. Mode - Choose ARP Detect, Strict ARP Detect or Ping Detect for the system to execute for WAN detection. If you choose Ping Detect as the detection mode, you have to type required settings for the following items. <ul style="list-style-type: none"> <li>● Primary/Secondary Ping IP - If you choose Ping Detect as detection mode, you have to type Primary or Secondary IP address in this field for pinging.</li> <li>● Ping Gateway IP - If you choose Ping Detect as detection mode, you also can enable this setting to use current WAN gateway IP address for pinging. With the IP address(es) pinging, Vigor router can check if the WAN connection is on or off.</li> <li>● TTL (Time to Live) - Set TTL value of PING operation.</li> <li>● Ping Interval - Enter the interval for the system to execute the PING operation.</li> <li>● Ping Retry - Enter the number of times that the system is allowed to execute the PING operation before WAN disconnection is judged.</li> </ul>																																																								

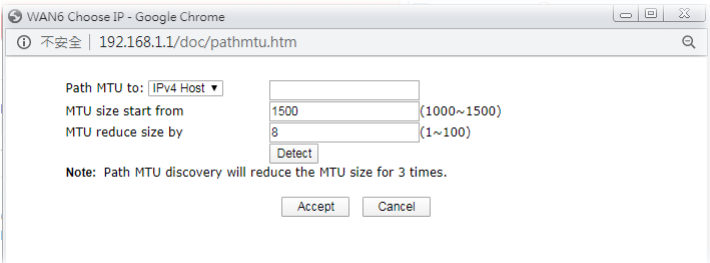
Schedule Profiles	Set the wireless LAN to work at certain time interval only. You may choose up to 4 schedules out of the 15 schedules pre-defined in Applications >> Schedule setup. The default setting of this field is blank and the function will always work.
MTU	<p>It means Max Transmit Unit for packet.</p> <p>Path MTU Discovery - It is used to detect the maximum MTU size of a packet not to be segmented in specific transmit path.</p> <p>Click Choose IP to open the following dialog.</p>  <ul style="list-style-type: none"> <li>● Path MTU to - Enter the IP address as the specific transmit path.</li> <li>● MTU size start from - Determine the starting point value of the packet. Default setting is 1500.</li> <li>● MTU reduce size by- It determines the decreasing size of MTU value. For example, the number specified in this field is “8”. The maximum MTU size is “1500”. After clicking the “detect” button, the system will calculate and get the suitable MTU value such as 1500, 1492, 1484 and etc., automatically.</li> <li>● Detect - Click it to detect a suitable MTU value</li> <li>● Accept - After clicking it, the detected value will be displayed in the field of MTU.</li> </ul>
Authentication	<p>Select PAP only or PAP or CHAP for PPP authentication.</p> <p>Username - Enter the username for authentication (optional).</p> <p>Password - Enter the password for authentication (optional).</p>

After finishing all the settings here, please click OK to activate them.

## II-1-2-7 Details Page for 3G/4G USB Modem (DHCP mode) in LTE WAN

It is available for “L” model only. LTE WAN uses the embedded LTE module to access internet.

To use 3G/4G USB Modem (DHCP mode) as the accessing protocol of the internet, please choose Internet Access from WAN menu. Then, select 3G/4G USB Modem (DHCP mode) for LTE. The following web page will be shown.

WAN >> Internet Access ?

---

LTE

3G/4G LTE Modem(DHCP mode)	IPv6
<input checked="" type="radio"/> Enable <input type="radio"/> Disable	
SIM PIN code <input type="text"/> Network Mode <span>4G/3G/2G</span> (Default:4G/3G/2G) APN Name <input type="text"/> <input type="checkbox"/> Disable Auto APN LTE hardware version 20000	
<b>Keep WAN Connection</b> <input checked="" type="checkbox"/> Enable PING to keep alive (Timeout: 10 secs.) PING to the IP <input type="text" value="8.8.8.8"/> <input type="checkbox"/> Connection Latency Check Latency <input type="text" value="800"/> ms Latency Duration <input type="text" value="60"/> seconds	
<b>WAN Connection Detection</b> Mode <span>ARP Detect</span>	
<b>Schedule Profile:</b> <input type="text" value="None"/> => <input type="text" value="None"/> => <input type="text" value="None"/> => <input type="text" value="None"/>	
MTU <input type="text" value="1500"/> (Default:1500) Path MTU Discovery <input type="button" value="Choose IP"/>	
<b>Authentication</b> <span>PAP or CHAP</span> Username <input type="text"/> (Optional) Password <input type="text"/> (Optional)	
<b>Preferred LTE Band Network Scan</b> <input type="checkbox"/> Enable Bridge Mode Bridge Subnet <span>LAN 1</span> <input type="checkbox"/> Bridge Specific MAC Address <input type="text" value="00:00:00:00:00:00"/>	

**Note:**

- Please note that in some case USB port connection will be terminated temporarily to activate the new configuration.
- Preferred LTE band setting will take effect until next LTE connection.
- VPN feature may be affected when the value of MTU is changed, please also check your value of VPN mss by using "VPN mss set" command.  
We recommend to put the same decreased value on VPN mss. For example, reducing the MTU from 1500 -> 1400, then it will need to reduce 100 from mss value.



 

Available settings are explained as follows:

Item	Description
Enable	Click Enable for activating this function. If you click Disable, this function will be closed and all the settings that you adjusted in this page will be invalid.
SIM PIN code	Enter PIN code of the SIM card that will be used to access Internet. The maximum length of the PIN code you can set is 15 characters.
Network Mode	Force Vigor router to connect Internet with the mode specified here. If you choose 4G/3G/2G as network mode, the router will choose a suitable one according to the actual wireless signal automatically.

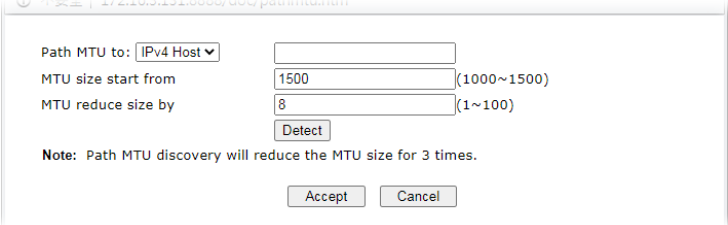

APN Name	<p>APN means Access Point Name which is provided and required by some ISPs. Enter the name and click Apply. The maximum length of the name you can set is 47 characters.</p> <p>Disable Auto APN - In default, the APN name will be given automatically (through pre-configured APN profile list) by Vigor router system. To specify an APN name, check this box and enter the APN name manually in the field of APN Name.</p>
LTE hardware version	The hardware version of the embedded LTE module.
Keep WAN Connection	<p>Normally, this function is designed for Dynamic IP environments because some ISPs will drop connections if there is no traffic within certain periods of time. Check Enable PING to keep alive box to activate this function.</p> <p>Enable PING to Keep alive - If you enable the PING function, please specify an IP address for the system to PING it for keeping alive. Vigor system will send a packet per second to the specified IP address. If the system does not receive any reply from that IP within 10 seconds, Vigor system will reboot LTE module until successfully set LTE connection.</p> <ul style="list-style-type: none"> <li>● PING to the IP - Enter an IP address.</li> </ul> <p>Connection Latency Check - Enable the latency time setting for packet reply. If it is enabled (checked), Vigor system will wait for the packet reply from the specified IP address. When the time of waiting packet reply reaches the time threshold (defined in Latency) and continues for a period of time (defined in Latency Duration), Vigor system will reboot LTE module until successfully set LTE connection.</p> <ul style="list-style-type: none"> <li>● Latency - Set a time threshold for packet reply. Default value is 800 (unit: micro-second).</li> <li>● Latency Duration - Set a time period. Default value is 60 (unit: second).</li> </ul>
WAN Connection Detection	<p>Such function allows you to verify whether network connection is alive or not through ARP Detect or Ping Detect. Mode - Choose ARP Detect or Ping Detect for the system to execute for WAN detection. If you choose Ping Detect as the detection mode, you have to type required settings for the following items.</p> <ul style="list-style-type: none"> <li>● Primary/Secondary Ping IP - If you choose Ping Detect as detection mode, you have to type Primary or Secondary IP address in this field for pinging.</li> <li>● Ping Gateway IP - If you choose Ping Detect as detection mode, you also can enable this setting to use current WAN gateway IP address for pinging.</li> <li>● With the IP address(es) pinging, Vigor router can check if the WAN connection is on or off.</li> <li>● TTL (Time to Live) - Set TTL value of PING operation.</li> <li>● Ping Interval - Enter the interval for the system to execute the PING operation.</li> <li>● Ping Retry - Enter the number of times that the system is allowed to execute the PING operation before WAN disconnection is judged.</li> </ul>
Schedule Profile	<p>Set the LTE WAN to work at certain time interval only. Specify up to 4 time schedule entries to enable or disable the WAN. All the schedules can be set previously in Applications &gt;&gt; Schedule web page and you can use the number that you</p>

	have set in that web page.
<p>MTU</p>	<p>Maximum Transmission Unit, the size of the largest packet, in bytes, that can be transmitted to the WAN. The maximum value is 1500.</p> <p>Path MTU Discovery - Use this feature to determine the optimal MTU size for the WAN.</p> <p>Click Choose IP to open the following dialog.</p>  <ul style="list-style-type: none"> <li>● Path MTU to - Select Host / IP, for an IPv4 address or Host / IPv6, for an IPv6 address, and then enter the IP address in the textbox.</li> <li>● MTU size start from - Determine the starting point value of the packet.</li> <li>● MTU reduce size by - Number of octets by which to decrease the 1500-byte MTU. Start with a 0 value for the reduce size and click the Detect button. If the message Fail is returned, increase the MTU reduce size and try again. Repeat until you see the message Success, indicating that the optimal MTU size has been reached.</li> <li>● Detect - Click it to detect a suitable MTU value</li> <li>● Accept - After clicking it, the detected value will be displayed in the field of MTU.</li> </ul>
<p>Authentication</p>	<p>The protocol used for PPP authentication.</p> <ul style="list-style-type: none"> <li>● PAP only - Only PAP (Password Authentication Protocol) is used.</li> <li>● PAP or CHAP - Both PAP and CHAP (Challenge-Handshake Authentication Protocol) can be used for PPP authentication. Router negotiates with the PPTP or L2TP server to determine which protocol to use.</li> </ul> <p>Username -Username provided by the ISP for authentication (optional).</p> <p>Password -Password provided by the ISP for authentication (optional).</p>
<p>Preferred LTE Band</p>	<p>Click the link to specify the preferred LTE band. A dialog will be open and list available LTE bands supported by the LTE module for the user to choose for establishing the network connection.</p> 
<p>Network Scan</p>	<p>Click it to search the nearby ISP for LTE connection. The following dialog lists available ISP services detected by Vigor router.</p>

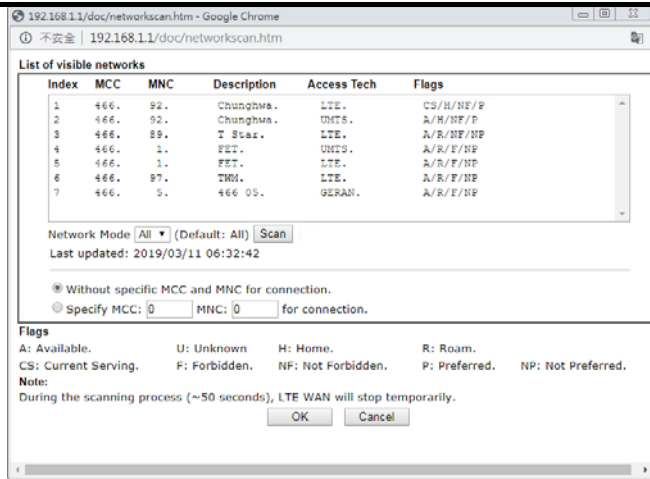

Enable Bridge Mode

If the function is enabled, the router will work as a LTE bridge modem.

Bridge Specific MAC Address - Enter the MAC address of the device (e.g., a computer, router or a WiFi router) which needs to be connected to the Internet through the LTE modem.

After finishing all the settings here, please click OK to activate them.

## II-1-2-8 Details Page for IPv6 – Offline in WAN1/WAN2/WAN5/WAN6

When Offline is selected, the IPv6 connection will be disabled.

WAN >> Internet Access



WAN 1

PPPoE	Static or Dynamic IP	PPTP/L2TP	IPv6
<b>Internet Access Mode</b>			
Connection Type		Offline ▼	

OK

Cancel

## II-1-2-9 Details Page for IPv6 – PPP in WAN1/WAN2

WAN >> Internet Access



### WAN 1

PPPoE	Static or Dynamic IP	PPTP/L2TP	IPv6
<b>Internet Access Mode</b> Connection Type: <input type="text" value="PPP"/>			
<b>WAN Connection Detection</b> Mode: <input type="text" value="Ping Detect"/> Ping IP/Hostname: <input type="text"/> TTL(1-255,0:Auto): <input type="text" value="0"/>			
<b>RIPng Protocol</b> <input type="checkbox"/> Enable			

**Note:**

IPv4 WAN setting should be PPPoE / PPPoA client.

Available settings are explained as follows:

Item	Description
WAN Connection Detection	<p>Such function allows you to verify whether network connection is alive or not through Ping Detect.</p> <p>Mode - Choose Always On or Ping Detect for the system to execute for WAN detection. Always On means no detection will be executed. The network connection will be on always.</p> <ul style="list-style-type: none"> <li>● Ping IP/Hostname - If you choose Ping Detect as detection mode, you have to type IP address in this field for pinging.</li> <li>● TTL (Time to Live) -If you choose Ping Detect as detection mode, you have to type TTL value.</li> </ul>
RIPng Protocol	RIPng (RIP next generation) offers the same functions and benefits as IPv4 RIP v2.

Below shows an example for successful IPv6 connection based on PPP mode.

## Online Status

Physical Connection		System Uptime: 0:2:32	
IPv4	IPv6		
<b>LAN Status</b>			
<b>IP Address</b>			
2001:B010:7300:201:21D:AFF:FEA6:2568/64 (Global)			
FE80::21D:AFF:FEA6:2568/64 (Link)			
<b>TX Packets</b>	<b>RX Packets</b>	<b>TX Bytes</b>	<b>RX Bytes</b>
7	4	690	328
<b>WAN2 IPv6 Status</b> <span style="float: right;">&gt;&gt; <u>Drop PPP</u></span>			
<b>Enable</b>	<b>Mode</b>	<b>Up Time</b>	
Yes	PPP	0:02:08	
<b>IP</b>		<b>Gateway IP</b>	
2001:B010:7300:201:21D:AFF:FEA6:256A/128 (Global)		FE80::90:1A00:242:AD52	
FE80::1D:AFF:FEA6:256A/128 (Link)			
<b>DNS IP</b>			
2001:B000:168::1			
2001:B000:168::2			
<b>TX Packets</b>	<b>RX Packets</b>	<b>TX Bytes</b>	<b>RX Bytes</b>
7	9	544	1126



### Info

At present, the IPv6 prefix can be acquired via the PPPoE mode connection which is available for the areas such as Taiwan (hinet), the Netherlands, Australia and UK.

## II-1-2-10 Details Page for IPv6 – TSPC in WAN1/WAN2/WAN5/WAN6

Tunnel setup protocol client (TSPC) is an application which could help you to connect to IPv6 network easily.

Please make sure your IPv4 WAN connection is OK and apply one free account from hexago (<http://gogonet.gogo6.com/page/freenet6-account>) before you try to use TSPC for network connection. TSPC would connect to tunnel broker and requests a tunnel according to the specifications inside the configuration file. It gets a public IPv6 IP address and an IPv6 prefix from the tunnel broker and then monitors the state of the tunnel in background.

After getting the IPv6 prefix and starting router advertisement daemon (RADVD), the PC behind this router can directly connect to IPv6 the Internet.



**WAN 1**

PPPoE	Static or Dynamic IP	PPTP/L2TP	IPv6
<b>Internet Access Mode</b>			
Connection Type		TSPC ▼	
<b>TSPC Configuration</b>			
Username		Max: 63 characters	
Password		Max: 63 characters	
Tunnel Broker			
<b>WAN Connection Detection</b>			
Mode		Ping Detect ▼	
Ping IP/Hostname			
TTL(1-255,0:Auto)		0	

Available settings are explained as follows:

Item	Description
Username	It is suggested for you to apply another username and password for <a href="http://gogonet.gogo6.com/page/freenet6-account">http://gogonet.gogo6.com/page/freenet6-account</a> . The maximum length of the name you can set is 63 characters.
Password	Enter the password assigned with the user name. The maximum length of the name you can set is 19 characters.
Tunnel Broker	Enter the address for the tunnel broker IP, FQDN or an optional port number.
WAN Connection Detection	Such function allows you to verify whether network connection is alive or not through Ping Detect. Mode - Choose Always On or Ping Detect for the system to execute for WAN detection. Always On means no detection will be executed. The network connection will be on always. <ul style="list-style-type: none"> <li>● Ping IP/Hostname - If you choose Ping Detect as detection mode, you have to type IP address in this field for pinging.</li> <li>● TTL (Time to Live) -If you choose Ping Detect as detection mode, you have to type TTL value.</li> </ul>

After finished the above settings, click OK to save the settings.

## II-1-2-11 Details Page for IPv6 – AICCU in WAN1/WAN2/WAN5/WAN6

WAN >> Internet Access



**WAN 1**

PPPoE	Static or Dynamic IP	PPTP/L2TP	IPv6
<b>Internet Access Mode</b> Connection Type: <span style="border: 1px solid black; padding: 2px;">AICCU</span>			
<b>AICCU Configuration</b> <input type="checkbox"/> Always On Username: <input type="text" value="Max: 63 characters"/> Password: <input type="text" value="Max: 63 characters"/> Tunnel Broker: <input type="text" value="tic.sixxs.net"/> Tunnel ID: <input type="text"/> Subnet Prefix: <input type="text"/> / <input type="text"/>			
<b>WAN Connection Detection</b> Mode: <span style="border: 1px solid black; padding: 2px;">Ping Detect</span> Ping IP/Hostname: <input type="text"/> TTL(1-255,0:Auto): <input type="text" value="0"/>			

**Note:**

If "Always On" is not enabled, AICCU connection would only retry three times.

Available settings are explained as follows:

Item	Description
Always On	Check this box to keep the network connection always.
Username	Enter the name obtained from the broker. Please apply new account at <a href="http://www.sixxs.net/">http://www.sixxs.net/</a> . It is suggested for you to apply another username and password. The maximum length of the name you can set is 19 characters.
Password	Enter the password assigned with the user name. The maximum length of the password you can set is 19 characters.
Tunnel Broker	It means a server of AICCU. The server can provide IPv6 tunnels to sites or end users over IPv4. Enter the address for the tunnel broker IP, FQDN or an optional port number.
Tunnel ID	One user account may have several tunnels. And, each tunnel shall have one specified tunnel ID (e.g., T115394). Enter the ID offered by Tunnel Broker.
Subnet Prefix	Enter the subnet prefix address obtained from service provider. The maximum length of the prefix you can set is 128 characters.
WAN Connection Detection	Such function allows you to verify whether network connection is alive or not through Ping Detect. Mode - Choose Always On or Ping Detect for the system to

	<p>execute for WAN detection.</p> <ul style="list-style-type: none"> <li>● Ping IP/Hostname - If you choose Ping Detect as detection mode, you have to type IP address in this field for pinging.</li> <li>● TTL (Time to Live) -If you choose Ping Detect as detection mode, you have to type TTL value.</li> </ul>
--	--

After finished the above settings, click OK to save the settings.

## II-1-2-12 Details Page for IPv6 – DHCPv6 Client in WAN1/WAN2

DHCPv6 client mode would use DHCPv6 protocol to obtain IPv6 address from server.

WAN >> Internet Access



**WAN 1**

PPPoE	Static or Dynamic IP	PPTP/L2TP	IPv6
<b>Internet Access Mode</b>			
Connection Type		DHCPv6 Client	
<b>DHCPv6 Client Configuration</b>			
IAID (Identity Association ID)		44176419	
DUID (DHCP Unique ID)		000300011449bc0237e9	
Authentication Protocol		None	
<b>WAN Connection Detection</b>			
Mode		Ping Detect	
Ping IP/Hostname			
TTL(1-255,0:Auto)		0	
<b>RIPng Protocol</b>			
<input type="checkbox"/> Enable			
<b>Bridge Mode</b>			
<input type="checkbox"/> Enable Bridge Mode			
Bridge Subnet		LAN 1	

Available settings are explained as follows:

Item	Description
DHCPv6 Client Configuration	<p>IAID - Type a number as IAID.</p> <p>DUID - Display the DHCP unique ID used by such WAN interface.</p> <p>Authentication Protocol - Such protocol will be used for the client to be authenticated by DHCPv6 server before accessing into Internet. There are three types can be specified, Reconfigure Key, Delayed and None. In general, the default setting is None.</p> <ul style="list-style-type: none"> <li>● Reconfigure Key - During the connection process, DHCPv6 server will authenticate the client automatically.</li> <li>● Delayed - During the connection process, DHCPv6 server will authenticate and identify the client based on the key ID, realm and secret information specified in these fields.</li> </ul> <p>Key ID - Type a value (range from 1 to 65535) which will</p>



	<p>be used to generate HMAC-MD5 value.</p> <p>Realm - The name (1 to 31 characters) typed here will identify the key which generates HMAC-MD5 value.</p> <p>Secret - Type a text (1 to 31 characters) as a unique identifier for each client on each DHCP server.</p>
WAN Connection Detection	<p>Such function allows you to verify whether network connection is alive or not through NS Detect or Ping Detect.</p> <p>Mode - Choose Always On, Ping Detect or NS Detect for the system to execute for WAN detection. With NS Detect mode, the system will check if network connection is established or not, like IPv4 ARP Detect. Always On means no detection will be executed. The network connection will be on always.</p> <ul style="list-style-type: none"> <li>● Ping IP/Hostname - If you choose Ping Detect as detection mode, you have to type IP address in this field for pinging.</li> <li>● TTL (Time to Live) -If you choose Ping Detect as detection mode, you have to type TTL value.</li> </ul>
RIPng Protocol	<p>RIPng (RIP next generation) offers the same functions and benefits as IPv4 RIP v2.</p>
Bridge Mode	<p>Enable Bridge Mode - If the function is enabled, the router will work as a bridge modem.</p> <p>Enable Firewall - It is available when Bridge Mode is enabled. When both Bridge Mode and Firewall check boxes are enabled, the settings configured (user profiles) under User Management will be ignored. And all of the filter rules defined and enabled in Firewall menu will be activated.</p> <p>Bridge Subnet - Make a bridge between the selected LAN subnet and such WAN interface.</p>

After finished the above settings, click OK to save the settings.

## II-1-2-13 Details Page for IPv6 – Static IPv6 in WAN1/WAN2

This type allows you to setup static IPv6 address for WAN interface.

WAN >> Internet Access ?

---

**WAN 1**

PPPoE	Static or Dynamic IP	PPTP/L2TP	IPv6						
<b>Internet Access Mode</b>									
Connection Type		Static IPv6 <span style="float: right;">▼</span>							
<b>Static IPv6 Address Configuration</b>									
IPv6 Address		/ Prefix Length							
<input type="text"/>		/ <input type="text"/> <input type="button" value="Add"/> <input type="button" value="Update"/> <input type="button" value="Delete"/>							
<b>Current IPv6 Address Table</b>									
Index	IPv6 Address/Prefix Length	Scope							
<table border="1" style="width: 100%; border-collapse: collapse;"> <thead> <tr> <th style="width: 5%;">Index</th> <th style="width: 70%;">IPv6 Address/Prefix Length</th> <th style="width: 25%;">Scope</th> </tr> </thead> <tbody> <tr> <td> </td> <td> </td> <td> </td> </tr> </tbody> </table>				Index	IPv6 Address/Prefix Length	Scope			
Index	IPv6 Address/Prefix Length	Scope							
<b>Static IPv6 Gateway configuration</b>									
IPv6 Gateway Address		<input type="text"/>							
<b>WAN Connection Detection</b>									
Mode		Ping Detect <span style="float: right;">▼</span>							
Ping IP/Hostname		<input type="text"/>							
TTL(1-255,0:Auto)		<input type="text" value="0"/>							
<b>RIPng Protocol</b>									
<input type="checkbox"/> Enable									
<b>Bridge Mode</b>									
<input type="checkbox"/> Enable Bridge Mode									
Bridge Subnet		LAN 1 <span style="float: right;">▼</span>							

Available settings are explained as follows:

Item	Description
Static IPv6 Address Configuration	IPv6 Address - Enter the IPv6 Static IP Address. Prefix Length - Enter the fixed value for prefix length. Add - Click it to add a new entry. Update - Click it to modify an existed entry. Delete - Click it to remove an existed entry.
Current IPv6 Address Table	Display current interface IPv6 address.
Static IPv6 Gateway Configuration	IPv6 Gateway Address - Type your IPv6 gateway address here.
WAN Connection Detection	Such function allows you to verify whether network connection is alive or not through Ping Detect. Mode - Choose Always On or Ping Detect for the system to execute for WAN detection. Always On means no detection will be executed. The network connection will be on always.

	<ul style="list-style-type: none"> <li>● Ping IP/Hostname - If you choose Ping Detect as detection mode, you have to type IP address in this field for pinging.</li> <li>● TTL (Time to Live) -If you choose Ping Detect as detection mode, you have to type TTL value.</li> </ul>
RIPng Protocol	RIPng (RIP next generation) offers the same functions and benefits as IPv4 RIP v2.
Bridge Mode	<p>Enable Bridge Mode - If the function is enabled, the router will work as a bridge modem.</p> <p>Enable Firewall - It is available when Bridge Mode is enabled. When both Bridge Mode and Firewall check boxes are enabled, the settings configured (user profiles) under User Management will be ignored. And all of the filter rules defined and enabled in Firewall menu will be activated.</p> <p>Bridge Subnet - Make a bridge between the selected LAN subnet and such WAN interface.</p>

After finished the above settings, click OK to save the settings.

## II-1-2-14 Details Page for IPv6 – 6in4 Static Tunnel in WAN1/WAN2

This type allows you to setup 6in4 Static Tunnel for WAN interface.

Such mode allows the router to access IPv6 network through IPv4 network.

However, 6in4 offers a prefix outside of 2002::0/16. So, you can use a fixed endpoint rather than anycast endpoint. The mode has more reliability.

WAN >> Internet Access ?

---

**WAN 1**

PPPoE	Static or Dynamic IP	PPTP/L2TP	IPv6
<b>Internet Access Mode</b>			
Connection Type: <span style="border: 1px solid gray; padding: 2px;">6in4 Static Tunnel</span>			
<b>6in4 Static Tunnel</b>			
Remote Endpoint IPv4 Address		<input style="width: 100%;" type="text"/>	
6in4 IPv6 Address		<input style="width: 80%;" type="text"/> / <span style="border: 1px solid gray; padding: 2px;">64</span> (default:64)	
LAN Routed Prefix		<input style="width: 80%;" type="text"/> / <span style="border: 1px solid gray; padding: 2px;">64</span> (default:64)	
Tunnel TTL		<input style="width: 40%;" type="text" value="255"/> (default:255)	
<b>WAN Connection Detection</b>			
Mode		<span style="border: 1px solid gray; padding: 2px;">Ping Detect</span>	
Ping IP/Hostname		<input style="width: 100%;" type="text"/>	
TTL(1-255,0:Auto)		<input style="width: 40%;" type="text" value="0"/>	

Available settings are explained as follows:

Item	Description
6in4 Static Tunnel	<p>Remote Endpoint IPv4 Address - Enter the static IPv4 address for the remote server.</p> <p>6in4 IPv6 Address - Enter the static IPv6 address for IPv4 tunnel with the value for prefix length.</p> <p>LAN Routed Prefix - Enter the static IPv6 address for LAN routing with the value for prefix length.</p>

	Tunnel TTL - Enter the number for the data lifetime in tunnel.
WAN Connection Detection	<p>Such function allows you to verify whether network connection is alive or not through Ping Detect.</p> <p>Mode - Choose Always On or Ping Detect for the system to execute for WAN detection. Always On means no detection will be executed. The network connection will be on always.</p> <ul style="list-style-type: none"> <li>● Ping IP/Hostname - If you choose Ping Detect as detection mode, you have to type IP address in this field for pinging.</li> <li>● TTL (Time to Live) -If you choose Ping Detect as detection mode, you have to type TTL value.</li> </ul>

After finished the above settings, click OK to save the settings.

Below shows an example for successful IPv6 connection based on 6in4 Static Tunnel mode.

**Online Status**

Physical Connection		System Uptime: 0day 0:4:16	
IPv4		IPv6	
<b>LAN Status</b>			
<b>IP Address</b>			
2001:4DD0:FF00:83E4:21D:AAFF:FE83:11B4/64 (Global)			
FE80::21D:AAFF:FE83:11B4/64 (Link)			
<b>TX Packets</b>	<b>RX Packets</b>	<b>TX Bytes</b>	<b>RX Bytes</b>
14	80	1244	6815
<b>WAN1 IPv6 Status</b>			
<b>Enable</b>	<b>Mode</b>	<b>Up Time</b>	
Yes	6in4 Static Tunnel	0:04:07	
<b>IP</b>		<b>Gateway IP</b>	
2001:4DD0:FF10:83E4::2131/64 (Global)		---	
FE80::C0A8:651D/128 (Link)			
<b>TX Packets</b>	<b>RX Packets</b>	<b>TX Bytes</b>	<b>RX Bytes</b>
3	26	211	2302

## II-1-2-15 Details Page for IPv6 – 6rd in WAN1/WAN2

This type allows you to setup 6rd for WAN interface.

WAN >> Internet Access



**WAN 1**

PPPoE	Static or Dynamic IP	PPTP/L2TP	IPv6
<b>Internet Access Mode</b>			
Connection Type			6rd
<b>6rd Settings</b>			
6rd Mode		<input type="radio"/> Auto 6rd <input checked="" type="radio"/> Static 6rd	
<b>Static 6rd Settings</b>			
IPv4 Border Relay:	<input type="text"/>		
IPv4 Mask Length:	<input type="text" value="0"/>		
6rd Prefix:	<input type="text"/>		
6rd Prefix Length:	<input type="text" value="0"/>		
<b>WAN Connection Detection</b>			
Mode	Ping Detect		
Ping IP/Hostname	<input type="text"/>		
TTL(1-255,0:Auto)	<input type="text" value="0"/>		

OK   Cancel

Available settings are explained as follows:

Item	Description
6rd Mode	Auto 6rd - Retrieve 6rd prefix automatically from 6rd service provider. The IPv4 WAN must be set as "DHCP". Static 6rd - Set 6rd options manually.
IPv4 Border Relay	Enter the IPv4 addresses of the 6rd Border Relay for a given 6rd domain.
IPv4 Mask Length	Type a number of high-order bits that are identical across all CE IPv4 addresses within a given 6rd domain. It may be any value between 0 and 32.
6rd Prefix	Enter the 6rd IPv6 address.
6rd Prefix Length	Enter the IPv6 prefix length for the 6rd IPv6 prefix in number of bits.
WAN Connection Detection	Such function allows you to verify whether network connection is alive or not through Ping Detect. Mode - Choose Always On or Ping Detect for the system to execute for WAN detection. Always On means no detection will be executed. The network connection will be on always. <ul style="list-style-type: none"> <li>● Ping IP/Hostname - If you choose Ping Detect as detection mode, you have to type IP address in this field for pinging.</li> <li>● TTL (Time to Live) -If you choose Ping Detect as detection mode, you have to type TTL value.</li> </ul>

After finished the above settings, click OK to save the settings.

Below shows an example for successful IPv6 connection based on 6rd mode.

Online Status

Physical Connection

System Uptime: 0day 0:9:15

IPv4	IPv6		
<b>LAN Status</b>			
<b>IP Address</b>			
2001:E41:A865:1D00:21D:AAFF:FE83:11B4/64 (Global)			
FE80::21D:AAFF:FE83:11B4/64 (Link)			
<b>TX Packets</b>	<b>RX Packets</b>	<b>TX Bytes</b>	<b>RX Bytes</b>
15	113	1354	18040
<b>WAN1 IPv6 Status</b>			
<b>Enable</b>	<b>Mode</b>	<b>Up Time</b>	
Yes	6rd	0:09:06	
<b>IP</b>			<b>Gateway IP</b>
2001:E41:A865:1D01:21D:AAFF:FE83:11B5/128 (Global)			---
FE80::C0A8:651D/128 (Link)			
<b>TX Packets</b>	<b>RX Packets</b>	<b>TX Bytes</b>	<b>RX Bytes</b>
13	29	967	2620

## II-1-3 Multi-VLAN

Multi-VLAN allows users to create profiles for specific WAN interface and bridge connections for user applications that require very high network throughput. Simply go to WAN and select Multi-VLAN.

- Channel 1/2: Ethernet on WAN1/WAN2.
- Channel 3: Wireless 2.4GHz on WAN3.
- Channel 4: Wireless 5GHz on WAN4.
- Channel 5/6: USB1/USB2 (WAN5/WAN6).

Channels 7 through 16 can be bridged to one or more of the 4 LAN ports P2 through P5. In addition, Channels 7 through 9 can be configured as virtual WANs (WAN7 through WAN9).

### General

WAN >> Multi-VLAN

Multi-VLAN

		General		Port-based Bridge					Wireless LAN(2.4GHz)				Wireless LAN(5GHz)				
Channel	Enable	WAN Type	VLAN Tag	Enable	P1	P2	P3	P4	P5	SSID1	SSID2	SSID3	SSID4	SSID1	SSID2	SSID3	SSID4
1	<input checked="" type="checkbox"/>	Ethernet(WAN1)	None														
2	<input checked="" type="checkbox"/>	Ethernet(WAN2)	None														
7	<input type="checkbox"/>	Ethernet(WAN1)	None	<input type="checkbox"/>	<input type="checkbox"/>	<input type="checkbox"/>	<input type="checkbox"/>	<input type="checkbox"/>	<input type="checkbox"/>	<input type="checkbox"/>	<input type="checkbox"/>	<input type="checkbox"/>	<input type="checkbox"/>	<input type="checkbox"/>	<input type="checkbox"/>	<input type="checkbox"/>	<input type="checkbox"/>
8	<input type="checkbox"/>	Ethernet(WAN1)	None	<input type="checkbox"/>	<input type="checkbox"/>	<input type="checkbox"/>	<input type="checkbox"/>	<input type="checkbox"/>	<input type="checkbox"/>	<input type="checkbox"/>	<input type="checkbox"/>	<input type="checkbox"/>	<input type="checkbox"/>	<input type="checkbox"/>	<input type="checkbox"/>	<input type="checkbox"/>	<input type="checkbox"/>
9	<input type="checkbox"/>	Ethernet(WAN1)	None	<input type="checkbox"/>	<input type="checkbox"/>	<input type="checkbox"/>	<input type="checkbox"/>	<input type="checkbox"/>	<input type="checkbox"/>	<input type="checkbox"/>	<input type="checkbox"/>	<input type="checkbox"/>	<input type="checkbox"/>	<input type="checkbox"/>	<input type="checkbox"/>	<input type="checkbox"/>	<input type="checkbox"/>
10	<input type="checkbox"/>	Ethernet(WAN1)	None	<input type="checkbox"/>	<input type="checkbox"/>	<input type="checkbox"/>	<input type="checkbox"/>	<input type="checkbox"/>	<input type="checkbox"/>	<input type="checkbox"/>	<input type="checkbox"/>	<input type="checkbox"/>	<input type="checkbox"/>	<input type="checkbox"/>	<input type="checkbox"/>	<input type="checkbox"/>	<input type="checkbox"/>
11	<input type="checkbox"/>	Ethernet(WAN1)	None	<input type="checkbox"/>	<input type="checkbox"/>	<input type="checkbox"/>	<input type="checkbox"/>	<input type="checkbox"/>	<input type="checkbox"/>	<input type="checkbox"/>	<input type="checkbox"/>	<input type="checkbox"/>	<input type="checkbox"/>	<input type="checkbox"/>	<input type="checkbox"/>	<input type="checkbox"/>	<input type="checkbox"/>
12	<input type="checkbox"/>	Ethernet(WAN1)	None	<input type="checkbox"/>	<input type="checkbox"/>	<input type="checkbox"/>	<input type="checkbox"/>	<input type="checkbox"/>	<input type="checkbox"/>	<input type="checkbox"/>	<input type="checkbox"/>	<input type="checkbox"/>	<input type="checkbox"/>	<input type="checkbox"/>	<input type="checkbox"/>	<input type="checkbox"/>	<input type="checkbox"/>
13	<input type="checkbox"/>	Ethernet(WAN1)	None	<input type="checkbox"/>	<input type="checkbox"/>	<input type="checkbox"/>	<input type="checkbox"/>	<input type="checkbox"/>	<input type="checkbox"/>	<input type="checkbox"/>	<input type="checkbox"/>	<input type="checkbox"/>	<input type="checkbox"/>	<input type="checkbox"/>	<input type="checkbox"/>	<input type="checkbox"/>	<input type="checkbox"/>
14	<input type="checkbox"/>	Ethernet(WAN1)	None	<input type="checkbox"/>	<input type="checkbox"/>	<input type="checkbox"/>	<input type="checkbox"/>	<input type="checkbox"/>	<input type="checkbox"/>	<input type="checkbox"/>	<input type="checkbox"/>	<input type="checkbox"/>	<input type="checkbox"/>	<input type="checkbox"/>	<input type="checkbox"/>	<input type="checkbox"/>	<input type="checkbox"/>
15	<input type="checkbox"/>	Ethernet(WAN1)	None	<input type="checkbox"/>	<input type="checkbox"/>	<input type="checkbox"/>	<input type="checkbox"/>	<input type="checkbox"/>	<input type="checkbox"/>	<input type="checkbox"/>	<input type="checkbox"/>	<input type="checkbox"/>	<input type="checkbox"/>	<input type="checkbox"/>	<input type="checkbox"/>	<input type="checkbox"/>	<input type="checkbox"/>
16	<input type="checkbox"/>	Ethernet(WAN1)	None	<input type="checkbox"/>	<input type="checkbox"/>	<input type="checkbox"/>	<input type="checkbox"/>	<input type="checkbox"/>	<input type="checkbox"/>	<input type="checkbox"/>	<input type="checkbox"/>	<input type="checkbox"/>	<input type="checkbox"/>	<input type="checkbox"/>	<input type="checkbox"/>	<input type="checkbox"/>	<input type="checkbox"/>

Note:

1. Greyed out or hidden WANs are reserved.
2. Ports configured for bridge mode cannot be selected in LAN >> VLAN Configuration.

OK

Cancel

Available settings are explained as follows:

Item	Description
Channel	Display the number of each channel. Channels 7 - 16 are configurable.
Enable	Display whether the settings in this channel are enabled (Yes) or not (No).
WAN Type	Displays the physical medium that the channel will use.
VLAN Tag	Displays the VLAN tag value that will be used for the packets traveling on this channel.
Port-based Bridge	The network traffic flowing on each channel will be identified by the system via their VLAN Tags. Channels using the same WAN type may not configure the same VLAN tag value. Enable - Check this box to enable the port-based bridge function on this channel. P1 ~ P5 - Check the box(es) to build bridge connection on LAN.

To configure a PVC channel, click its channel number.

WAN links for Channel 7, 8 and 9 are provided for router-borne application such as TR-069. The settings must be applied and obtained from your ISP. For your special request, please contact with your ISP and then click WAN link of Channel 7, 8 and 9 to configure your router.

Internet Access >> Multi-VLAN >> Channel 7

Enable Channel 7 :

WAN Type : Ethernet(WAN1) ▾

---

**General Settings**

VLAN Header

VLAN Tag: 0      Service Tag Value: Disable Modify

Priority: 0 ▾

**Note:**  
Tag value must be set between 1~4095 and unique for each channel.  
Only one channel can be untagged (equal to 0) at a time.

---

Open Port-based Bridge Connection for this Channel

Physical Members

P1    P2    P3    P4    P5

Wireless LAN(2.4GHz)

SSID1    SSID2    SSID3    SSID4

Wireless LAN(5GHz)

SSID1    SSID2    SSID3    SSID4

**Note:**  
1. P1 is reserved for NAT use, and cannot be configured for bridge mode.  
2. If the port be configured for bridge mode, the setting of the port in LAN >> VLAN Configuration will not work.

---

Open WAN Interface for this Channel

WAN Application:  VoIP    IPTV

WAN Setup: Static or Dynamic IP ▾

---

<p><b>ISP Access Setup</b></p> <p>ISP Name <span style="border: 1px solid black; display: inline-block; width: 100px; height: 15px;"></span></p> <p>Username <span style="border: 1px solid black; display: inline-block; width: 100px; height: 15px;"></span></p> <p>Password <span style="border: 1px solid black; display: inline-block; width: 100px; height: 15px;"></span></p> <p>PPP Authentication <span style="border: 1px solid black; padding: 2px;">PAP or CHAP ▾</span></p> <p><input checked="" type="checkbox"/> Always On</p> <p>Idle Timeout <span style="border: 1px solid black; padding: 2px;">-1</span> second(s)</p> <p><b>IP Address From ISP</b></p> <p>Fixed IP   <input type="radio"/> Yes   <input checked="" type="radio"/> No (Dynamic IP)</p> <p>Fixed IP Address <span style="border: 1px solid black; display: inline-block; width: 100px; height: 15px;"></span></p>	<p><b>WAN IP Network Settings</b></p> <p><input type="radio"/> Obtain an IP address automatically</p> <p>Router Name <span style="border: 1px solid black; padding: 2px;">Vigor</span> *</p> <p>Domain Name <span style="border: 1px solid black; display: inline-block; width: 100px; height: 15px;"></span> *</p> <p>*: Required for some ISPs</p> <p><input checked="" type="radio"/> Specify an IP address</p> <p>IP Address <span style="border: 1px solid black; display: inline-block; width: 100px; height: 15px;"></span></p> <p>Subnet Mask <span style="border: 1px solid black; display: inline-block; width: 100px; height: 15px;"></span></p> <p>Gateway IP Address <span style="border: 1px solid black; display: inline-block; width: 100px; height: 15px;"></span></p> <p><b>DNS Server IP Address</b></p> <p>Primary IP Address <span style="border: 1px solid black; padding: 2px;">8.8.8.8</span></p> <p>Secondary IP Address <span style="border: 1px solid black; padding: 2px;">8.8.4.4</span></p>
---	---

OK   Cancel

Available settings are explained as follows:

Item	Description
Enable Channel 7/8/9	Check it to enable this channel.
WAN Type	Specify a WAN type of the VLAN. Ethernet (WAN1/2) - A VLAN will be created on WAN1/2.
General Settings	VLAN Tag - Enter the value as the VLAN ID number. Valid settings are in the range from 1 to 4095. The network traffic flowing on each channel will be identified by the system via their VLAN Tags. Channels using the same WAN type may not



	<p>configure the same VLAN tag value.</p> <p>Priority - Choose the number to determine the packet priority for such VLAN. The range is from 0 to 7.</p> <p>Service Tag Value - Such value varies depending on the setting configured in WAN&gt;&gt;General Setup. If required, click Modify to open WAN&gt;&gt;General Setup. Then, enable VLAN Tag insertion for service (outer tag) and specify the value as the VLAN ID number. Or, disable it.</p>
Open Port-based Bridge Connection for this Channel	<p>The settings here will create a bridge between the LAN ports selected and the WAN. The WAN interface of the bridge connection will be built upon the WAN type selected using the VLAN tag configured.</p> <p>Physical Members - Group the physical ports by checking the corresponding check box(es) for applying the port-based bridge connection.</p> <p>Wireless LAN (2GHz/5GHz) - Group the SSIDs by checking the corresponding check box(es) for applying the port-based bridge connection.</p> <p>Note: LAN port P1 is reserved for NAT use and cannot be selected for bridging.</p>
Open WAN Interface for this Channel	<p>Check the box to enable relating function.</p> <p>WAN Application - The intended usage of this channel.</p> <ul style="list-style-type: none"> <li>● IPTV - IGMP packets can be sent to IPTV servers on this channel.</li> </ul> <p>WAN Setup - (Available when WAN type is VDSL or Ethernet(WAN2)) The WAN access method of this channel. Available options are PPPoE/PPPoA and Static or Dynamic IP.</p> <ul style="list-style-type: none"> <li>● PPPoE/PPPoA - When PPPoE/PPPoA is selected, the ISP Access Setup and IP Address From ISP settings are available for configuration, and will be used to establish the WAN connection.</li> <li>● Static or Dynamic IP - When Static or Dynamic IP is selected, the WAN IP Network Settings and DNS Server IP Address settings are available for configuration, and will be used to establish the WAN connection.</li> </ul>
ISP Access Setup	<p>Enter your allocated username, password and authentication parameters according to the information provided by your ISP.</p> <p>ISP Name - PPP Service Name. Enter if your ISP requires this setting; otherwise leave blank.</p> <p>Username - Name provided by the ISP for PPPoE/PPPoA authentication. Maximum length is 62 characters.</p> <p>Password - Password provided by the ISP for PPPoE/PPPoA authentication. Maximum length is 62 characters.</p> <p>PPP Authentication -The protocol used for PPP authentication.</p> <ul style="list-style-type: none"> <li>● PAP only- Only PAP (Password Authentication Protocol) is used.</li> <li>● PAP or CHAP- Both PAP and CHAP (Challenge-Handshake Authentication Protocol) can be used for PPP authentication. Router negotiates with the PPTP or L2TP server to determine which protocol to use.</li> </ul> <p>Always On - If selected, the router will maintain the</p>

	<p>PPPoE/PPPoA connection.</p> <p>Idle Timeout - Maximum length of time, in seconds, of idling allowed (no traffic) before the connection is dropped.</p> <p>IP Address From ISP - Specifies how the WAN IP address of the channel configured.</p> <ul style="list-style-type: none"> <li>● Fixed IP <ul style="list-style-type: none"> <li>Yes - IP address entered in the Fixed IP Address field will be used as the IP address of the virtual WAN.</li> <li>No - Virtual WAN IP address will be assigned by the ISP's PPPoE/PPPoA server.</li> </ul> </li> </ul>
WAN IP Network Settings	<p>Obtain an IP address automatically - Select this option if the router is to receive IP configuration information from a DHCP server.</p> <ul style="list-style-type: none"> <li>● Router Name - Sets the value of DHCP Option 12, which is used by some ISPs.</li> <li>● Domain Name - Sets the value of DHCP Option 15, which is used by some ISPs.</li> </ul> <p>Specify an IP address - Select this option to manually enter the IP address.</p> <ul style="list-style-type: none"> <li>● IP Address - Type in the IP address.</li> <li>● Subnet Mask - Type in the subnet mask.</li> <li>● Gateway IP Address - Type in gateway IP address.</li> </ul> <p>DNS Server IP Address - Type in the primary IP address for the router if you want to use Static IP mode. If necessary, type in secondary IP address for necessity in the future.</p>

After finished the above settings, click OK to save the settings and return to previous page.

Click any index (10-16) to get the following web page:

Internet Access >> Multi-VLAN >> Channel 10

Enable Channel 10 :

WAN Type : Ethernet(WAN1) ▾

---

**General Settings**

VLAN Header

VLAN Tag: 0      Service Tag Value: Disable Modify

Priority: 0 ▾

**Note:**  
Tag value must be set between 1~4095 and unique for each channel.  
Only one channel can be untagged (equal to 0) at a time.

---

**Bridge mode**

Enable

Physical Members

P1    P2    P3    P4    P5

Wireless LAN(2.4GHz)

SSID1    SSID2    SSID3    SSID4

Wireless LAN(5GHz)

SSID1    SSID2    SSID3    SSID4

**Note:**  
1. P1 is reserved for NAT use, and cannot be configured for bridge mode.  
2. If the port be configured for bridge mode, the setting of the port in LAN >> VLAN Configuration will not work.

OK   Cancel

Available settings are explained as follows:

Item	Description
Enable Channel 10~16	Click it to enable the configuration of this channel.
WAN Type	The connections and interfaces created in every channel may select a specific WAN type to be built upon. In the Multi-VLAN application, only the Ethernet WAN type is available. The user will be able to select the physical WAN interface the channel shall use here.
General Settings	VLAN Tag - Enter the value as the VLAN ID number. Valid settings are in the range from 1 to 4095. The network traffic flowing on each channel will be identified by the system via their VLAN Tags. Channels using the same WAN type may not configure the same VLAN tag value.  Priority - Choose the number to determine the packet priority for such VLAN. The range is from 0 to 7.
Bridge mode	Enable - Click it to enable Bridge mode for such channel.  Physical Members - Group the physical ports by checking the corresponding check box(es) for applying the bridge connection.  Wireless LAN (2GHz/5GHz) - Group the SSIDs by checking the corresponding check box(es) for applying the bridge connection.  Note: LAN port P1 is reserved for NAT use and cannot be selected for bridging.

After finished the above settings, click OK to save the settings.

## II-1-4 WAN Budget

This function is used to determine the data *traffic volume* for each WAN interface respectively to prevent from overcharges for data transmission by the ISP. Please note that the Quota Limit and Billing cycle day of month settings will need to be configured correctly first in order for some period calculations to be performed correctly.

### II-1-4-1 General Setup

WAN >> WAN Budget



General Setup		Status			
Index	Enable	Quota	When quota exceeded	Time cycle	Duration
<a href="#">WAN1</a>	<input type="checkbox"/>	0MB/0MB			0/00/00 00:00~0/00/00 00:00
<a href="#">WAN2</a>	<input type="checkbox"/>	0MB/0MB			0/00/00 00:00~0/00/00 00:00
<a href="#">WAN3</a>	<input type="checkbox"/>	0MB/0MB			0/00/00 00:00~0/00/00 00:00
<a href="#">WAN4</a>	<input type="checkbox"/>	0MB/0MB			0/00/00 00:00~0/00/00 00:00
<a href="#">WAN5</a>	<input type="checkbox"/>	0MB/0MB			0/00/00 00:00~0/00/00 00:00
<a href="#">WAN6</a>	<input type="checkbox"/>	0MB/0MB			0/00/00 00:00~0/00/00 00:00

Note:

1. The budget traffic information provided here is for reference only, please consult your ISP for the actual traffic usage and charges.
2. When hardware acceleration function is used, the monitored WAN traffic of Ethernet WAN interfaces may be slightly inaccurate.

OK

Cancel

or

WAN >> WAN Budget



General Setup		Status			
Index	Enable	Quota	When quota exceeded	Time cycle	Duration
<a href="#">WAN1</a>	<input type="checkbox"/>	0MB/0MB			0/00/00 00:00~0/00/00 00:00
<a href="#">WAN2</a>	<input type="checkbox"/>	0MB/0MB			0/00/00 00:00~0/00/00 00:00
<a href="#">WAN3</a>	<input type="checkbox"/>	0MB/0MB			0/00/00 00:00~0/00/00 00:00
<a href="#">WAN4</a>	<input type="checkbox"/>	0MB/0MB			0/00/00 00:00~0/00/00 00:00
<a href="#">LTE</a>	<input type="checkbox"/>	0MB/0MB			0/00/00 00:00~0/00/00 00:00
<a href="#">WAN6</a>	<input type="checkbox"/>	0MB/0MB			0/00/00 00:00~0/00/00 00:00

Note:

1. The budget traffic information provided here is for reference only, please consult your ISP for the actual traffic usage and charges.
2. When hardware acceleration function is used, the monitored WAN traffic of Ethernet WAN interfaces may be slightly inaccurate.

OK

Cancel

Item	Description
Index	The WAN port. Click to configure WAN Budget for a particular WAN.
Enable	v - WAN Budget is enabled on this WAN. x - WAN Budget is disabled on this WAN.
Quota	The current cycle's Internet usage is expressed as $x/y$ where $x$ is the cumulative usage and $y$ is the upper limit. For example, 100MB/200MB means the usage thus far in this cycle is 100MB, and the upper limit is 200MB.

When quota exceeded	Actions to be taken once the quota is reached. Shutdown - WAN will be disabled. Mail Alert - Email will be sent to the administrator.
Time cycle	Reset frequency of the usage data. Monthly - The Monthly option in the Criterion and Action tab was used to set up the usage quota. User Defined: The User Defined option in the Criterion and Action tab was used to set up the usage qota.
Duration	Start and end timestamps of the current cycle.

Click WAN1 (to WAN6) or LTE link to open the following web page.

WAN >> WAN Budget

**WAN 1**

Enable

Criterion and Action

---

Quota Limit:  MB

When quota exceeded :

Shutdown WAN interface

Using **Notification Object**

Set **Mail Alert** or **SMS message**.

**Monthly**      **Custom**

Select the day of a month when your (cellular) data resets.

Data quota resets on day  at

**Note:**

1. Please make sure the **Time and Date** of the router is configured.
2. SMS message and mail will be sent when the usage reaches 95% and 100% of quota.

Available settings are explained as follows:

Item	Description
Enable	Check the box to enable such function.
Quota Limit	Enter the data traffic quota allowed for such WAN interface. There are two unit (MB and GB) offered for you to specify.
When quota exceeded	Check the box(es) as the condition(s) for the system to perform when the traffic has exceeded the budget limit. Shutdown WAN interface - All the outgoing traffic through such WAN interface will be terminated. <ul style="list-style-type: none"> <li>● Using Notification Object - The system will send out a notification based on the content of the notification object.</li> <li>● Set Mail Alert - The system will send out a warning message to the administrator when the quota is running out. However, the connection charges will be calculated continuously.</li> <li>● Set SMS message - The system will send out SMS message to the administrator when the quota is running out.</li> </ul>
Monthly	Some ISP might apply for the network limitation based on the traffic limit per month. This setting is to offer a mechanism of resetting the traffic record every month.

	<div style="text-align: center;"> <span style="border: 1px solid gray; padding: 2px 10px; margin-right: 10px;">Monthly</span> <span style="border: 1px solid gray; padding: 2px 10px;">Custom</span> </div> <p>Select the day of a month when your (cellular) data resets. Data quota resets on day <span style="border: 1px solid gray; padding: 0 5px;">1</span> at <span style="border: 1px solid gray; padding: 0 5px;">00:00</span></p> <p>Data quota resets on day ... - You can determine the starting day in one month.</p>
Custom	<p>This setting allows the user to define the billing cycle according to his request. The WAN budget will be reset with an interval of billing cycle.</p> <p>Monthly is default setting. If long period or a short period is required, use Custom. The period of cycle duration is between 1 day and 60 days. You can determine the cycle duration by specifying the days and the hours. In addition, you can specify which day of today is in a cycle.</p> <p>Use Cycle in hours -</p> <div style="border: 1px solid gray; padding: 5px; margin-bottom: 10px;"> <p><b>WAN 1</b></p> <p><input type="checkbox"/> Enable</p> <p>Criterion and Action</p> <p>Quota Limit: <span style="border: 1px solid gray; padding: 0 5px;">0</span> MB</p> <p>When quota exceeded : <input type="checkbox"/> Shutdown WAN interface Using <b>Notification Object</b> ----- Set <b>Mail Alert</b> or <b>SMS message</b>.</p> <div style="text-align: center;"> <span style="border: 1px solid gray; padding: 2px 10px; margin-right: 10px;">Monthly</span> <span style="border: 1px solid gray; padding: 2px 10px;">Custom</span> </div> <p><input checked="" type="radio"/> Use Cycle in hours <input type="radio"/> Use Cycle in days</p> <p>Usage counter resets at the beginning of each cycle. Cycle duration : <span style="border: 1px solid gray; padding: 0 5px;">1</span> days and <span style="border: 1px solid gray; padding: 0 5px;">0</span> hours Today is day <span style="border: 1px solid gray; padding: 0 5px;">1</span> in the cycle.</p> </div> <p><b>Note:</b></p> <ol style="list-style-type: none"> <li>Please make sure the <b>Time and Date</b> of the router is configured.</li> <li>SMS message and mail will be sent when the usage reaches 95% and 100% of quota.</li> </ol> <ul style="list-style-type: none"> <li>● <b>Cycle duration:</b> Specify the days and hours to reset the traffic record. For example, 7 means the whole cycle is 7 days; 20 means the whole cycle is 20 days. When the time is up, the router will reset the traffic record automatically.</li> <li>● <b>Today is day -</b> Specify the day in the cycle as the starting point which Vigor router will reset the traffic record. For example, "3" means the third day of the cycle duration.</li> </ul> <p>Use Cycle in days -</p> <div style="border: 1px solid gray; padding: 5px; margin-bottom: 10px;"> <p><b>WAN &gt;&gt; WAN Budget</b></p> <hr/> <p><b>WAN 1</b></p> <p><input type="checkbox"/> Enable</p> <p>Criterion and Action</p> <p>Quota Limit: <span style="border: 1px solid gray; padding: 0 5px;">0</span> MB</p> <p>When quota exceeded : <input type="checkbox"/> Shutdown WAN interface Using <b>Notification Object</b> ----- Set <b>Mail Alert</b> or <b>SMS message</b>.</p> <div style="text-align: center;"> <span style="border: 1px solid gray; padding: 2px 10px; margin-right: 10px;">Monthly</span> <span style="border: 1px solid gray; padding: 2px 10px;">Custom</span> </div> <p><input type="radio"/> Use Cycle in hours <input checked="" type="radio"/> Use Cycle in days</p> <p>Usage counter resets at the beginning of each cycle. Cycle duration : <span style="border: 1px solid gray; padding: 0 5px;">1</span> days. Today is day <span style="border: 1px solid gray; padding: 0 5px;">1</span> in the cycle and data quota resets at <span style="border: 1px solid gray; padding: 0 5px;">00:00</span></p> </div> <ul style="list-style-type: none"> <li>● <b>Cycle duration:</b> Specify the days to reset the traffic record. For example, 7 means the whole cycle is 7 days; 20 means the whole cycle is 20 days. When the time is up, the router will reset the traffic record automatically.</li> <li>● <b>Today is day -</b> Specify the day and time for data quota rest in the cycle as the starting point which Vigor router</li> </ul>

will reset the traffic record. For example, “3” means the third day of the cycle duration.

After finished the above settings, click OK to save the settings.

## II-1-4-2 Status

The status page displays the status WAN budget, including the duration and the usage.

WAN >> WAN Budget

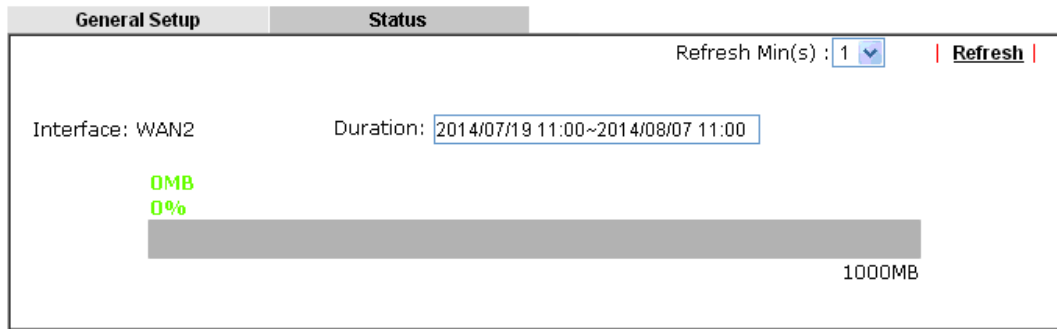

If the WAN budget is exhausted, a lock will be displayed on the page if Shutdown WAN interface is selected. Which means no data transmission will be carried out. Moreover, the system will send out a warning message to the administrator if Mail Alert is selected. Or, the system will send out SMS message to the administrator if SMS message is selected.

WAN >> WAN Budget

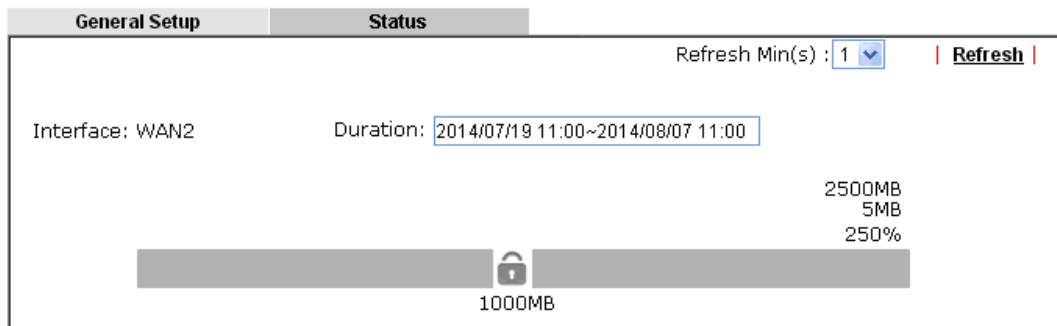

# Application Notes

## A-1 How to set up Multi-PVC for triple play deployment?

By adding VLAN tags to differentiate the traffic, the service provider is able to deliver video, voice, and data to the subscribers over a single connection, which is also known as the triple play service. This document is going to demonstrate how to configure the Multi-PVC feature for triple play deployment. There are two types of setup, one is doing port-based bridge that will connect the media, such as the set-top box (STB), directly to the service provider via a specific LAN port; the other is opening a virtual WAN interface and doing NAT for the application.

### Bridge the Virtual WAN to a LAN port

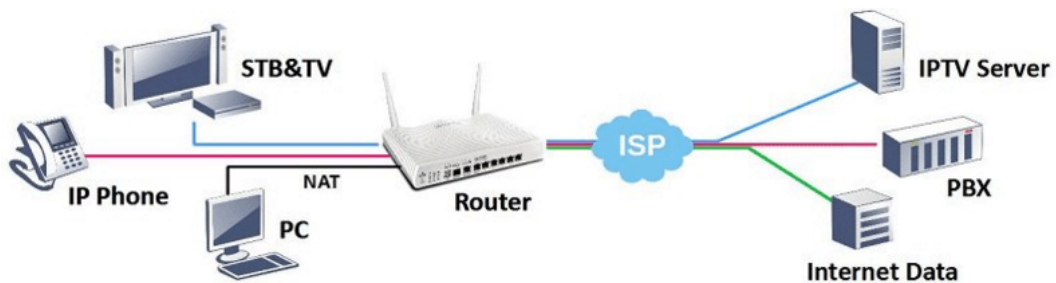

1. Go to WAN >> Multi-VLAN, click on a channel to configure.

WAN >> Multi-VLAN



#### Multi-VLAN

##### General

Channel	Enable	WAN Type	VLAN Tag	Port-based Bridge
1	<input checked="" type="checkbox"/>	Ethernet(WAN1)	None	
2	<input checked="" type="checkbox"/>	Ethernet(WAN2)	None	
7. WAN7	<input type="checkbox"/>	Ethernet(WAN1)	None	<input type="checkbox"/> Enable <input type="checkbox"/> P1 <input type="checkbox"/> P2 <input type="checkbox"/> P3 <input type="checkbox"/> P4 <input type="checkbox"/> P5
8. WAN8	<input type="checkbox"/>	Ethernet(WAN1)	None	<input type="checkbox"/> Enable <input type="checkbox"/> P1 <input type="checkbox"/> P2 <input type="checkbox"/> P3 <input type="checkbox"/> P4 <input type="checkbox"/> P5
9. WAN9	<input type="checkbox"/>	Ethernet(WAN1)	None	<input type="checkbox"/> Enable <input type="checkbox"/> P1 <input type="checkbox"/> P2 <input type="checkbox"/> P3 <input type="checkbox"/> P4 <input type="checkbox"/> P5
10.	<input type="checkbox"/>	Ethernet(WAN1)	None	<input type="checkbox"/> Enable <input type="checkbox"/> P1 <input type="checkbox"/> P2 <input type="checkbox"/> P3 <input type="checkbox"/> P4 <input type="checkbox"/> P5
11.	<input type="checkbox"/>	Ethernet(WAN1)	None	<input type="checkbox"/> Enable <input type="checkbox"/> P1 <input type="checkbox"/> P2 <input type="checkbox"/> P3 <input type="checkbox"/> P4 <input type="checkbox"/> P5
12.	<input type="checkbox"/>	Ethernet(WAN1)	None	<input type="checkbox"/> Enable <input type="checkbox"/> P1 <input type="checkbox"/> P2 <input type="checkbox"/> P3 <input type="checkbox"/> P4 <input type="checkbox"/> P5
13.	<input type="checkbox"/>	Ethernet(WAN1)	None	<input type="checkbox"/> Enable <input type="checkbox"/> P1 <input type="checkbox"/> P2 <input type="checkbox"/> P3 <input type="checkbox"/> P4 <input type="checkbox"/> P5
14.	<input type="checkbox"/>	Ethernet(WAN1)	None	<input type="checkbox"/> Enable <input type="checkbox"/> P1 <input type="checkbox"/> P2 <input type="checkbox"/> P3 <input type="checkbox"/> P4 <input type="checkbox"/> P5
15.	<input type="checkbox"/>	Ethernet(WAN1)	None	<input type="checkbox"/> Enable <input type="checkbox"/> P1 <input type="checkbox"/> P2 <input type="checkbox"/> P3 <input type="checkbox"/> P4 <input type="checkbox"/> P5
16.	<input type="checkbox"/>	Ethernet(WAN1)	None	<input type="checkbox"/> Enable <input type="checkbox"/> P1 <input type="checkbox"/> P2 <input type="checkbox"/> P3 <input type="checkbox"/> P4 <input type="checkbox"/> P5

**Note:**

Channel 5 and channel 6 are reserved for USB WAN.

OK Cancel



- Configure the channel as follows,

WAN >> Multi-VLAN >> Channel 10

Enable Channel 10:  
 WAN Type : Ethernet(WAN1) ▾

**General Settings**

VLAN Header

VLAN Tag:  Service Tag Value: Disable Modify

Priority: 0 ▾

**Note:**  
 Tag value must be set between 1~4095 and unique for each channel.  
 Only one channel can be untagged (equal to 0) at a time.

---

**Bridge mode**

Enable

Physical Members

P1  P2  P3  P4  P5

**Note:**  
 P1 is reserved for NAT use, and cannot be configured for bridge mode.

OK Cancel

- enable this channel.
  - set WAN Type to the WAN interface that the service provider is on.
  - enable Add VLAN Header and enter the VLAN Tag and Priority as the service provider requires.
  - check Enable for Bridge Mode, and select the physical port member to which you're going to connect the STB.
- Click OK to save the configuration, the configuration will be displayed on the main page. And now you may connect the STB to the Bridged port to use the IPTV service.

WAN >> Multi-VLAN



Multi-VLAN

General				
Channel	Enable	WAN Type	VLAN Tag	Port-based Bridge
1	<input checked="" type="checkbox"/>	Ethernet(WAN1)	None	
2	<input checked="" type="checkbox"/>	Ethernet(WAN2)	None	
7. WAN7	<input type="checkbox"/>	Ethernet(WAN1)	None	<input type="checkbox"/> Enable <input type="checkbox"/> P1 <input type="checkbox"/> P2 <input type="checkbox"/> P3 <input type="checkbox"/> P4 <input type="checkbox"/> P5
8. WAN8	<input type="checkbox"/>	Ethernet(WAN1)	None	<input type="checkbox"/> Enable <input type="checkbox"/> P1 <input type="checkbox"/> P2 <input type="checkbox"/> P3 <input type="checkbox"/> P4 <input type="checkbox"/> P5
9. WAN9	<input type="checkbox"/>	Ethernet(WAN1)	None	<input type="checkbox"/> Enable <input type="checkbox"/> P1 <input type="checkbox"/> P2 <input type="checkbox"/> P3 <input type="checkbox"/> P4 <input type="checkbox"/> P5
10.	<input checked="" type="checkbox"/>	Ethernet(WAN1)	832	<input checked="" type="checkbox"/> Enable <input type="checkbox"/> P1 <input type="checkbox"/> P2 <input type="checkbox"/> P3 <input checked="" type="checkbox"/> P4 <input type="checkbox"/> P5
11.	<input type="checkbox"/>	Ethernet(WAN1)	None	<input type="checkbox"/> Enable <input type="checkbox"/> P1 <input type="checkbox"/> P2 <input type="checkbox"/> P3 <input type="checkbox"/> P4 <input type="checkbox"/> P5
12.	<input type="checkbox"/>	Ethernet(WAN1)	None	<input type="checkbox"/> Enable <input type="checkbox"/> P1 <input type="checkbox"/> P2 <input type="checkbox"/> P3 <input type="checkbox"/> P4 <input type="checkbox"/> P5
13.	<input type="checkbox"/>	Ethernet(WAN1)	None	<input type="checkbox"/> Enable <input type="checkbox"/> P1 <input type="checkbox"/> P2 <input type="checkbox"/> P3 <input type="checkbox"/> P4 <input type="checkbox"/> P5
14.	<input type="checkbox"/>	Ethernet(WAN1)	None	<input type="checkbox"/> Enable <input type="checkbox"/> P1 <input type="checkbox"/> P2 <input type="checkbox"/> P3 <input type="checkbox"/> P4 <input type="checkbox"/> P5
15.	<input type="checkbox"/>	Ethernet(WAN1)	None	<input type="checkbox"/> Enable <input type="checkbox"/> P1 <input type="checkbox"/> P2 <input type="checkbox"/> P3 <input type="checkbox"/> P4 <input type="checkbox"/> P5
16.	<input type="checkbox"/>	Ethernet(WAN1)	None	<input type="checkbox"/> Enable <input type="checkbox"/> P1 <input type="checkbox"/> P2 <input type="checkbox"/> P3 <input type="checkbox"/> P4 <input type="checkbox"/> P5

- Note:**
- Channel 3 and channel 4 and channel 5 and channel 6 are reserved for USB WAN.
  - If the port be configured for bridge mode, the setting of the port in LAN >> VLAN Configuration will not work.

OK Cancel

## Open a Virtual WAN Interface



1. Go to WAN >> Multi-PVC/VLAN, click on channel 7, 8 or 9 to configure.

WAN >> Multi-VLAN



### Multi-VLAN

#### General

Channel	Enable	WAN Type	VLAN Tag	Port-based Bridge
1	<input checked="" type="checkbox"/>	Ethernet(WAN1)	None	
2	<input checked="" type="checkbox"/>	Ethernet(WAN2)	None	
7. WAN7	<input type="checkbox"/>	Ethernet(WAN1)	None	<input type="checkbox"/> Enable <input type="checkbox"/> P1 <input type="checkbox"/> P2 <input type="checkbox"/> P3 <input type="checkbox"/> P4 <input type="checkbox"/> P5
8. WAN8	<input type="checkbox"/>	Ethernet(WAN1)	None	<input type="checkbox"/> Enable <input type="checkbox"/> P1 <input type="checkbox"/> P2 <input type="checkbox"/> P3 <input type="checkbox"/> P4 <input type="checkbox"/> P5
9. WAN9	<input type="checkbox"/>	Ethernet(WAN1)	None	<input type="checkbox"/> Enable <input type="checkbox"/> P1 <input type="checkbox"/> P2 <input type="checkbox"/> P3 <input type="checkbox"/> P4 <input type="checkbox"/> P5
10.	<input type="checkbox"/>	Ethernet(WAN1)	None	<input type="checkbox"/> Enable <input type="checkbox"/> P1 <input type="checkbox"/> P2 <input type="checkbox"/> P3 <input type="checkbox"/> P4 <input type="checkbox"/> P5
11.	<input type="checkbox"/>	Ethernet(WAN1)	None	<input type="checkbox"/> Enable <input type="checkbox"/> P1 <input type="checkbox"/> P2 <input type="checkbox"/> P3 <input type="checkbox"/> P4 <input type="checkbox"/> P5
12.	<input type="checkbox"/>	Ethernet(WAN1)	None	<input type="checkbox"/> Enable <input type="checkbox"/> P1 <input type="checkbox"/> P2 <input type="checkbox"/> P3 <input type="checkbox"/> P4 <input type="checkbox"/> P5
13.	<input type="checkbox"/>	Ethernet(WAN1)	None	<input type="checkbox"/> Enable <input type="checkbox"/> P1 <input type="checkbox"/> P2 <input type="checkbox"/> P3 <input type="checkbox"/> P4 <input type="checkbox"/> P5
14.	<input type="checkbox"/>	Ethernet(WAN1)	None	<input type="checkbox"/> Enable <input type="checkbox"/> P1 <input type="checkbox"/> P2 <input type="checkbox"/> P3 <input type="checkbox"/> P4 <input type="checkbox"/> P5
15.	<input type="checkbox"/>	Ethernet(WAN1)	None	<input type="checkbox"/> Enable <input type="checkbox"/> P1 <input type="checkbox"/> P2 <input type="checkbox"/> P3 <input type="checkbox"/> P4 <input type="checkbox"/> P5
16.	<input type="checkbox"/>	Ethernet(WAN1)	None	<input type="checkbox"/> Enable <input type="checkbox"/> P1 <input type="checkbox"/> P2 <input type="checkbox"/> P3 <input type="checkbox"/> P4 <input type="checkbox"/> P5

#### Note:

Channel 5 and channel 6 are reserved for USB WAN.

OK

Cancel

2. Configure the channel as follows,

WAN >> Multi-VLAN >> Channel 7

Enable Channel 7:  
WAN Type :

**General Settings**  
VLAN Header  
VLAN Tag:  Service Tag Value:    
Priority:

**Note:**  
Tag value must be set between 1~4095 and unique for each channel.  
Only one channel can be untagged (equal to 0) at a time.

Open Port-based Bridge Connection for this Channel  
Physical Members  
 P1  P2  P3  P4  P5  
**Note:**  
P1 is reserved for NAT use, and cannot be configured for bridge mode.

Open WAN Interface for this Channel  
WAN Application:  Management  IPTV  
WAN Setup:

**ISP Access Setup**  
ISP Name   
Username   
Password   
PPP Authentication:   
 Always On  
Idle Timeout:  second(s)  
**IP Address From ISP**  
Fixed IP  Yes  No (Dynamic IP)  
Fixed IP Address

**WAN IP Network Settings**  
 Obtain an IP address automatically  
Router Name  \*  
Domain Name  \*  
\*: Required for some ISPs  
 Specify an IP address  
IP Address   
Subnet Mask   
Gateway IP Address   
**DNS Server IP Address**  
Primary IP Address   
Secondary IP Address

- (a) enable this channel.
  - (b) set WAN Type to the WAN interface that the service provider is on.
  - (c) enter the VLAN Tag and Priority as the service provider requires.
  - (d) enable "Open WAN Interface for this Channel", and select the kind of Application will be used on this channel. (Note: this option is only available on channel 7-9)
  - (e) set up the Internet Access type as the ISP requires.
3. Click OK to save the profile and reboot the router to apply the settings. After the router restart, go to Online Status >> Virtual WAN to make sure the WAN interface is up and has obtained an IP address.

Online Status

Virtual WAN						System Uptime: 0day 0:1:23
<b>WAN 5 Status</b>						<a href="#">&gt;&gt; Release</a>
<b>Enable</b>	<b>Line</b>	<b>Name</b>	<b>Mode</b>	<b>Up Time</b>	<b>Application</b>	
Yes	Ethernet(WAN2)		DHCP Client	0:00:10	IPTV	
<b>IP</b>	<b>GW IP</b>	<b>TX Packets</b>	<b>TX Rate(Bps)</b>	<b>RX Packets</b>	<b>RX Rate(Bps)</b>	
10.15.15.20	10.15.15.1	0	0	2	27	
<b>WAN 6 Status</b>						
<b>Enable</b>	<b>Line</b>	<b>Name</b>	<b>Mode</b>	<b>Up Time</b>	<b>Application</b>	
No	ADSL		---	00:00:00	Management	
<b>IP</b>	<b>GW IP</b>	<b>TX Packets</b>	<b>TX Rate(Bps)</b>	<b>RX Packets</b>	<b>RX Rate(Bps)</b>	
---	---	0	0	0	0	
<b>WAN 7 Status</b>						
<b>Enable</b>	<b>Line</b>	<b>Name</b>	<b>Mode</b>	<b>Up Time</b>	<b>Application</b>	
No	ADSL		---	00:00:00	Management	
<b>IP</b>	<b>GW IP</b>	<b>TX Packets</b>	<b>TX Rate(Bps)</b>	<b>RX Packets</b>	<b>RX Rate(Bps)</b>	
---	---	0	0	0	0	

- Now, you may use the virtual WAN interface for applications such as IGMP Proxy, this can be done by selecting the WAN interface as "PVC/VLAN".

Applications >> IGMP

**General setting**      **Working status**

**IGMP Proxy**  
 IGMP Proxy acts as a multicast proxy for hosts on the LAN side. Enable IGMP proxy to access any multicast group. This function takes no effect when Bridge Mode is enabled.

Interface: PVC/VLAN

IGMP version: Auto

General Query Interval: 125 (seconds)

Add PPP header:

(Encapsulate IGMP in PPPoE)

Enable IGMP syslog:

**IGMP Snooping**  
 Enable: Forwards multicast traffic only to ports that are members of that group.  
 Disable: Treats multicast traffic the same as broadcast traffic.

**IGMP Fast Leave**  
 The router stops forwarding multicast traffic to a LAN port as soon as it receives a leave message from that port. Each LAN port should have no more than one IGMP host connected.

IGMP Accept List: Any

Only allow the IP of the LAN device to be included in the specified object/group to use IGMP.

## II-2 LAN

Local Area Network (LAN) is a group of subnets regulated and ruled by router. The design of network structure is related to what type of public IP addresses coming from your ISP.

The most generic function of Vigor router is NAT. It creates a private subnet of your own. As mentioned previously, the router will talk to other public hosts on the Internet by using public IP address and talking to local hosts by using its private IP address. What NAT does is to translate the packets from public IP address to private IP address to forward the right packets to the right host and vice versa. Besides, Vigor router has a built-in DHCP server that assigns private IP address to each local host. See the following diagram for a briefly understanding.

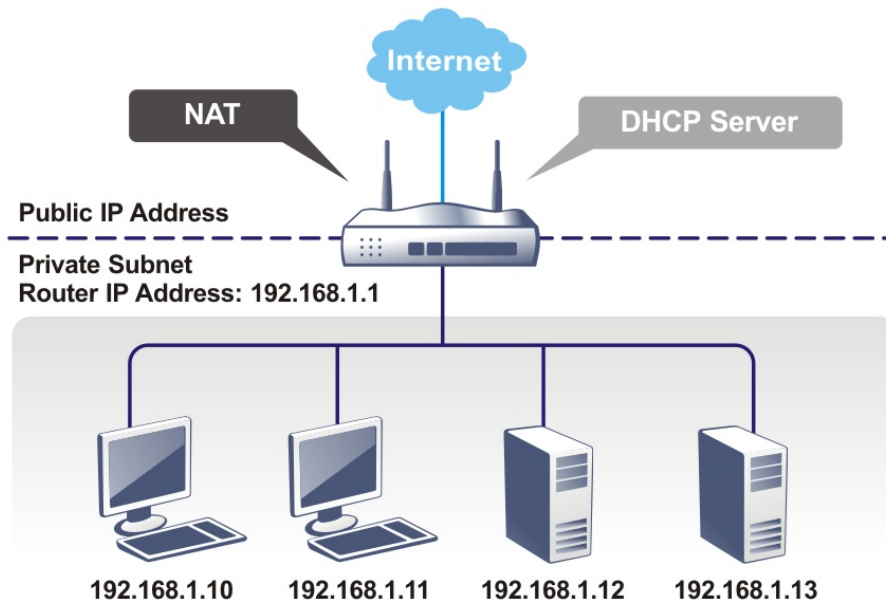

In some special case, you may have a public IP subnet from your ISP such as 220.135.240.0/24. This means that you can set up a public subnet or call second subnet that each host is equipped with a public IP address. As a part of the public subnet, the Vigor router will serve for IP routing to help hosts in the public subnet to communicate with other public hosts or servers outside. Therefore, the router should be set as the gateway for public hosts.

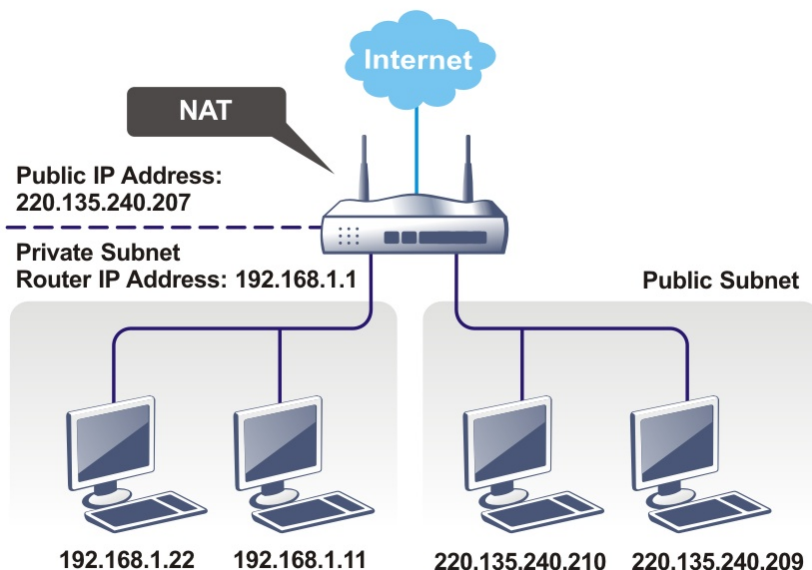

## What is Routing Information Protocol (RIP)

Vigor router will exchange routing information with neighboring routers using the RIP to accomplish IP routing. This allows users to change the information of the router such as IP address and the routers will automatically inform for each other.

## What is Static Route

When you have several subnets in your LAN, sometimes a more effective and quicker way for connection is the Static routes function rather than other method. You may simply set rules to forward data from one specified subnet to another specified subnet without the presence of RIP.

## What are Virtual LANs and Rate Control

You can group local hosts by physical ports and create up to 8 virtual LANs. To manage the communication between different groups, please set up rules in Virtual LAN (VLAN) function and the rate of each.

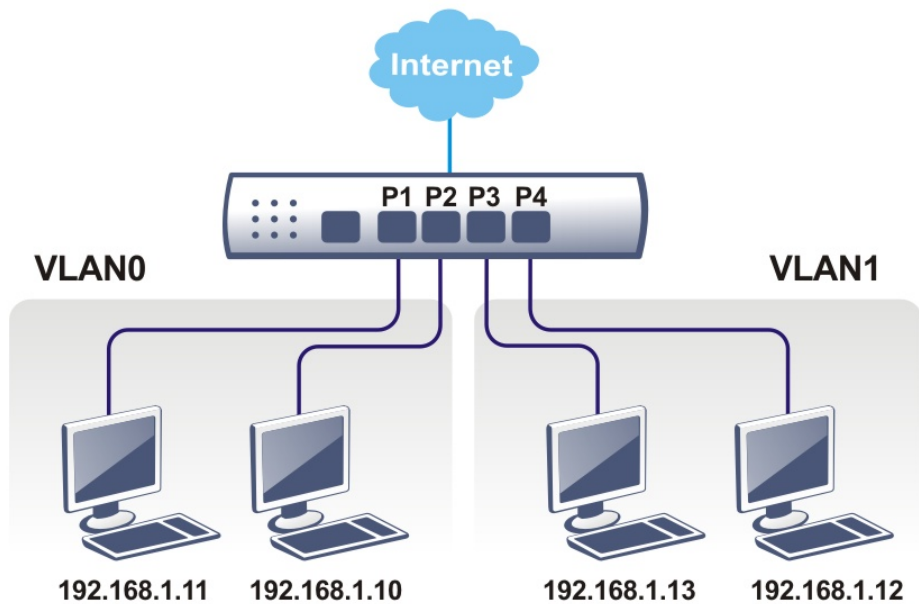

---

## Web User Interface

A LAN comprises a collection of LAN clients, which are networked devices on your premises. A LAN client can be a computer, a printer, a Voice-over-IP (VoIP) phone, a mobile phone, a gaming console, an Internet Protocol Television (IPTV), etc, and can have either a wired (using Ethernet cabling) or wireless (using Wi-Fi) network connection.

LAN clients within the same LAN are normally able to communicate with one another directly, as they are peers to one another, unless measures, such as firewalls or VLANs, have been put in place to restrict such access. Nowadays the most common LAN firewalls are implemented on the LAN client itself. For example, Microsoft Windows since Windows XP and Apple OS X have built-in firewalls that can be configured to restrict traffic coming in and going out of the computer. VLANs, on the other hand, are usually set up using network switches or routers, such as the Vigor2927.

To communicate with the hosts outside of the LAN, LAN clients have to go through a network gateway, which in most cases is a router (such as the Vigor 2862) that sits between the LAN and the ISP network, which is the WAN. The router acts as a director to ensure traffic between the LAN and the WAN reach their intended destinations.



---

### II-2-1 General Setup

This page provides you the general settings for LAN. Click LAN to open the LAN settings page and choose General Setup.

There are eight subnets provided by the router which allow users to divide groups into different subnets (LAN1 - LAN8). In addition, different subnets can link for each other by configuring Inter-LAN Routing. At present, LAN1 setting is fixed with NAT mode only. LAN2 - LAN8 can be operated under NAT or Route mode. IP Routed Subnet can be operated under Route mode.

LAN >> General Setup

General Setup

Index	Enable	DHCP	DHCPv6	IP Address		
LAN 1	V	V	V	192.168.1.1	Details Page	IPv6
LAN 2	<input type="checkbox"/>	<input checked="" type="checkbox"/>	<input checked="" type="checkbox"/>	192.168.2.1	Details Page	IPv6
LAN 3	<input type="checkbox"/>	<input checked="" type="checkbox"/>	<input checked="" type="checkbox"/>	192.168.3.1	Details Page	IPv6
LAN 4	<input type="checkbox"/>	<input checked="" type="checkbox"/>	<input checked="" type="checkbox"/>	192.168.4.1	Details Page	IPv6
LAN 5	<input type="checkbox"/>	<input checked="" type="checkbox"/>	<input checked="" type="checkbox"/>	192.168.5.1	Details Page	IPv6
LAN 6	<input type="checkbox"/>	<input checked="" type="checkbox"/>	<input checked="" type="checkbox"/>	192.168.6.1	Details Page	IPv6
LAN 7	<input type="checkbox"/>	<input checked="" type="checkbox"/>	<input checked="" type="checkbox"/>	192.168.7.1	Details Page	IPv6
LAN 8	<input type="checkbox"/>	<input checked="" type="checkbox"/>	<input checked="" type="checkbox"/>	192.168.8.1	Details Page	IPv6
DMZ Port	<input type="checkbox"/>	<input checked="" type="checkbox"/>	<input checked="" type="checkbox"/>	192.168.254.1	Details Page	IPv6
IP Routed Subnet	<input type="checkbox"/>	<input checked="" type="checkbox"/>		192.168.0.1	Details Page	

DHCP Server Option

Note:

Please enable LAN 2 - 8 on **LAN >> VLAN** page before configure them.  
 Enable DMZ port will make the LAN Port 5 neglect the setting on VLAN page, LAN Port 5 will become the DMZ Port.

Force router to use "DNS server IP address" settings specified in LAN1 LAN1 v

Inter-LAN Routing

Subnet	LAN 1	LAN 2	LAN 3	LAN 4	LAN 5	LAN 6	LAN 7	LAN 8	DMZ Port
LAN 1	<input checked="" type="checkbox"/>	<input type="checkbox"/>	<input type="checkbox"/>	<input type="checkbox"/>	<input type="checkbox"/>	<input type="checkbox"/>	<input type="checkbox"/>	<input type="checkbox"/>	<input type="checkbox"/>
LAN 2	<input type="checkbox"/>	<input checked="" type="checkbox"/>	<input type="checkbox"/>	<input type="checkbox"/>	<input type="checkbox"/>	<input type="checkbox"/>	<input type="checkbox"/>	<input type="checkbox"/>	<input type="checkbox"/>
LAN 3	<input type="checkbox"/>	<input type="checkbox"/>	<input checked="" type="checkbox"/>	<input type="checkbox"/>	<input type="checkbox"/>	<input type="checkbox"/>	<input type="checkbox"/>	<input type="checkbox"/>	<input type="checkbox"/>
LAN 4	<input type="checkbox"/>	<input type="checkbox"/>	<input type="checkbox"/>	<input checked="" type="checkbox"/>	<input type="checkbox"/>	<input type="checkbox"/>	<input type="checkbox"/>	<input type="checkbox"/>	<input type="checkbox"/>
LAN 5	<input type="checkbox"/>	<input type="checkbox"/>	<input type="checkbox"/>	<input type="checkbox"/>	<input checked="" type="checkbox"/>	<input type="checkbox"/>	<input type="checkbox"/>	<input type="checkbox"/>	<input type="checkbox"/>
LAN 6	<input type="checkbox"/>	<input type="checkbox"/>	<input type="checkbox"/>	<input type="checkbox"/>	<input type="checkbox"/>	<input checked="" type="checkbox"/>	<input type="checkbox"/>	<input type="checkbox"/>	<input type="checkbox"/>
LAN 7	<input type="checkbox"/>	<input type="checkbox"/>	<input type="checkbox"/>	<input type="checkbox"/>	<input type="checkbox"/>	<input type="checkbox"/>	<input checked="" type="checkbox"/>	<input type="checkbox"/>	<input type="checkbox"/>
LAN 8	<input type="checkbox"/>	<input type="checkbox"/>	<input type="checkbox"/>	<input type="checkbox"/>	<input type="checkbox"/>	<input type="checkbox"/>	<input type="checkbox"/>	<input checked="" type="checkbox"/>	<input type="checkbox"/>
DMZ Port	<input type="checkbox"/>	<input type="checkbox"/>	<input type="checkbox"/>	<input type="checkbox"/>	<input type="checkbox"/>	<input type="checkbox"/>	<input type="checkbox"/>	<input type="checkbox"/>	<input checked="" type="checkbox"/>

OK

Available settings are explained as follows:

Item	Description
General Setup	<p>Allow to configure settings for each subnet respectively.</p> <p>Index - Display all of the LAN items.</p> <p>Enable- Basically, LAN1 status is enabled in default. LAN2 -LAN8 and IP Routed Subnet can be observed by checking the box of Enable.</p> <p>DHCP/DHCPv6- LAN1 is configured with DHCP/DHCPv6 in default. If required, please check the DHCP box for each LAN.</p> <p>IP Address - Display the IP address for each LAN item. Such information is set in default and you can not modify it.</p> <p>Details Page - Click it to access into the setting page. Each LAN will have different LAN configuration page. Each LAN must be configured in different subnet.</p> <p>IPv6 - Click it to access into the settings page of IPv6.</p>
DHCP Server Option	<p>DHCP packets can be processed by adding option number and data information when such function is enabled.</p> <p>For detailed information, refer to later section.</p>



Force router to use “DNS server IP address ....”	Force Vigor router to use DNS servers configured in LAN1/LAN2/LAN3/LAN4/LAN5/LAN6/LAN7/LAN8/DMZ Port instead of DNS servers given by the Internet Access server (PPPoE, PPTP, L2TP or DHCP server).
Inter-LAN Routing	<p>Check the box to link two or more different subnets (LAN and LAN).</p> <p>Inter-LAN Routing allows different LAN subnets to be interconnected or isolated.</p> <p>It is only available when the VLAN functionality is enabled. Refer to section II-2-2 VLAN on how to set up VLANs.</p> <p>In the Inter-LAN Routing matrix, a selected checkbox means that the 2 intersecting LANs can communicate with each other.</p>

When you finish the configuration, please click OK to save and exit this page.



**Info**

To configure a subnet, select its Details Page button to bring up the LAN Details Page.

### II-2-1-1 Details Page for LAN1 – Ethernet TCP/IP and DHCP Setup

There are two configuration pages for LAN1, Ethernet TCP/IP and DHCP Setup (based on IPv4) and IPv6 Setup. Click the tab for each type and refer to the following explanations for detailed information.

LAN >> General Setup

LAN 1 Ethernet TCP / IP and DHCP Setup	LAN 1 IPv6 Setup
<p><b>Network Configuration</b> For NAT Usage</p> <p>IP Address <input type="text" value="192.168.1.1"/></p> <p>Subnet Mask <input type="text" value="255.255.255.0 / 24"/> ▼</p> <p><input type="button" value="LAN IP Alias"/></p> <hr/> <p>RIP Protocol Control <input type="text" value="Disable"/> ▼</p>	<p><b>DHCP Server Configuration</b></p> <p><input type="radio"/> Disable <input checked="" type="radio"/> Enable Server <input type="radio"/> Enable Relay Agent</p> <p>Start IP Address <input type="text" value="192.168.1.10"/></p> <p>IP Pool Counts <input type="text" value="200"/> (max. 1021)</p> <p>Gateway IP Address <input type="text" value="192.168.1.1"/></p> <p>Lease Time <input type="text" value="86400"/> (s)</p> <p><input checked="" type="checkbox"/> Clear DHCP lease for inactive clients periodically</p> <hr/> <p><b>DNS Server IP Address</b></p> <p>Primary IP Address <input type="text"/></p> <p>Secondary IP Address <input type="text"/></p>

**Note:** Change IP Address or Subnet Mask in Network Configuration will also change [HA](#) LAN1 Virtual IP to the same domain IP.

Available settings are explained as follows:

Item	Description
Network Configuration	<p>For NAT Usage,</p> <p>IP Address - This is the IP address of the router. (Default: 192.168.1.1).</p> <p>Subnet Mask - The subnet mask, together with the IP Address</p>

field, indicates the maximum number of clients allowed on the subnet. (Default: 255.255.255.0/ 24).

LAN IP Alias -Such feature allows specifying multiple gateways (under a switch) with different WAN interfaces for accessing the Internet via the Vigor router.

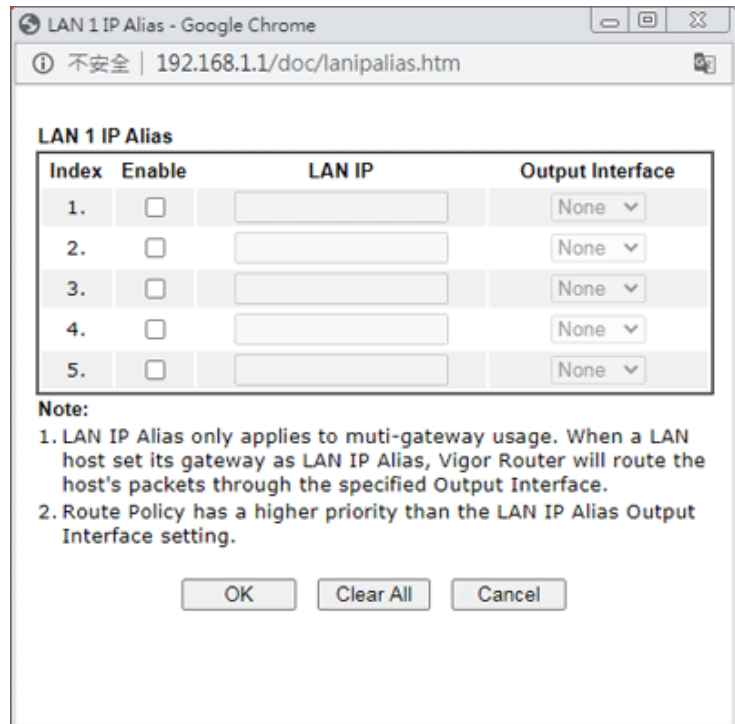

RIP Protocol Control,

Enable - When Enabled, the router will attempt to exchange routing information with neighbouring routers using the Routing Information Protocol.

### DHCP Server Configuration

DHCP stands for Dynamic Host Configuration Protocol. The router by factory default acts a DHCP server for your network so it automatically dispatches related IP settings to any local user configured as a DHCP client. It is highly recommended that you leave the router enabled as a DHCP server if you do not have a DHCP server for your network.

If you want to use another DHCP server in the network other than the Vigor Router's, you can let Relay Agent help you to redirect the DHCP request to the specified location.

Disable - Let you manually assign IP address to every host in the LAN.

Enable Server - Let the router assign IP address to every host in the LAN.

- Start IP Address - The beginning LAN IP address that is given out to LAN DHCP clients.
- IP Pool Counts - The maximum number of IP addresses to be handed out by DHCP. The default value is 200. Valid range is between 1 and 1021. The actual number of IP addresses available for assignment is the IP Pool Counts, or 1021 minus the last octet of the Start IP Address, whichever is smaller.
- Gateway IP Address - The IP address of the gateway, which is the host on the LAN that relays all traffic coming into and going out of the LAN. The gateway is normally the router, and therefore the Gateway IP

	<p>Address should be identical to the IP Address in the Network Configuration section above.</p> <ul style="list-style-type: none"> <li>● Lease Time - The maximum duration DHCP-issued IP addresses can be used before they have to be renewed.</li> <li>● Clear DHCP lease for inactive clients periodically - If selected, the router sends ARP requests recycles IP addresses previously assigned to inactive DHCP clients to prevent exhaustion of the IP address pool.</li> </ul> <p>Note: When Clear DHCP lease for inactive clients periodically is enabled, router will do the following:</p> <ul style="list-style-type: none"> <li>■ Check activities of DHCP clients by ARP requests every minute when the available DHCP IP addresses are less than 30</li> <li>■ Clear DHCP lease when the client is not responding ARP replies.</li> </ul> <p>Enable Relay Agent - When selected, all DHCP requests are forwarded to a DHCP server outside of the LAN subnet, and whose address is specified in the DHCP Server IP Address field.</p> <ul style="list-style-type: none"> <li>● DHCP Server IP Address - It is available when Enable Relay Agent is checked. Set the IP address of the DHCP server you are going to use so the Relay Agent can help to forward the DHCP request to the DHCP server.</li> </ul>																				
DNS Server IP Address	<p>DNS stands for Domain Name System. Every Internet host must have a unique IP address, also they may have a human-friendly, easy to remember name such as www.yahoo.com. The DNS server converts the user-friendly name into its equivalent IP address.</p> <p>Primary IP Address -You must specify a DNS server IP address here because your ISP should provide you with usually more than one DNS Server.</p> <p>Secondary IP Address - You can specify secondary DNS server IP address here because your ISP often provides you more than one DNS Server.</p> <p>The default DNS Server IP address can be found via Online Status:</p> <p>Online Status</p> <hr/> <p>Physical Connection <span style="float: right;">System Uptime: 22:22:45</span></p> <table border="1" style="width: 100%; border-collapse: collapse;"> <thead> <tr> <th colspan="2">IPv4</th> <th colspan="2">IPv6</th> <th>Secondary DNS: 8.8.4.4</th> </tr> </thead> <tbody> <tr> <td>LAN Status</td> <td>Primary DNS: 8.8.8.8</td> <td></td> <td></td> <td></td> </tr> <tr> <td>IP Address</td> <td>TX Packets</td> <td>RX Packets</td> <td></td> <td></td> </tr> <tr> <td>192.168.1.1</td> <td>0</td> <td>41533</td> <td></td> <td></td> </tr> </tbody> </table> <p>If both the Primary IP and Secondary IP Address fields are left empty, the router will assign DNS servers obtained from WAN interface to local users as a DNS proxy server and maintain a DNS cache. If there is no DNS servers available, router will use its own IP address instead.</p> <p>If the IP address of a domain name is already in the DNS cache, the router will resolve the domain name immediately. Otherwise, the router forwards the DNS query packet to the external DNS server by establishing a WAN (e.g. DSL/Cable) connection.</p>	IPv4		IPv6		Secondary DNS: 8.8.4.4	LAN Status	Primary DNS: 8.8.8.8				IP Address	TX Packets	RX Packets			192.168.1.1	0	41533		
IPv4		IPv6		Secondary DNS: 8.8.4.4																	
LAN Status	Primary DNS: 8.8.8.8																				
IP Address	TX Packets	RX Packets																			
192.168.1.1	0	41533																			

When you finish the configuration, please click OK to save and exit this page.

Private IP addresses can be assigned automatically to LAN clients using Dynamic Host Configuration Protocol (DHCP), or manually assigned. The DHCP server can either be the

router (the most common case), or a separate server, that hands out IP addresses to DHCP clients.

Alternatively, static IP addresses can be manually configured on LAN clients as part of their network settings. No matter how IP addresses are configured, it is important that no two devices get the same IP address. If both DHCP and static assignment are used on a network, it is important to exclude the static IP addresses from the DHCP IP pool. For example, if your LAN uses the 192.168.1.x subnet and you have 20 DHCP clients and 20 static IP clients, you could configure 192.168.1.10 as the Start IP Address, 50 as the IP Pool Counts (enough for the current number of DHCP clients, plus room for future expansion), and use addresses greater than 192.168.1.100 for static assignment.

## II-2-1-2 Details Page for LAN2 ~ LAN8 and DMZ

LAN >> General Setup

DMZ Ethernet TCP / IP and DHCP Setup	DMZ IPv6 Setup
<b>Network Configuration</b> <input type="radio"/> Enable <input checked="" type="radio"/> Disable <input checked="" type="radio"/> For NAT Usage <input type="radio"/> For Routing Usage IP Address <input type="text" value="192.168.254.1"/> Subnet Mask <input type="text" value="255.255.255.0"/>	<b>DHCP Server Configuration</b> <input type="radio"/> Disable <input checked="" type="radio"/> Enable Server <input type="radio"/> Enable Relay Agent Start IP Address <input type="text" value="192.168.254.10"/> IP Pool Counts <input type="text" value="100"/> (max. 253) Gateway IP Address <input type="text" value="192.168.254.1"/> Lease Time <input type="text" value="259200"/> (s) <input checked="" type="checkbox"/> Clear DHCP lease for inactive clients periodically.
<b>DNS Server IP Address</b> Primary IP Address <input type="text"/> Secondary IP Address <input type="text"/>	

**Note:** Change IP Address or Subnet Mask in Network Configuration will also change **HA** DMZ Virtual IP to the same domain IP.

OK

Available settings are explained as follows:

Item	Description
Network Configuration	<p>Enable/Disable - Click Enable to enable such configuration; click Disable to disable such configuration.</p> <p>For NAT Usage - Click this radio button to invoke NAT function.</p> <p>For Routing Usage - Click this radio button to invoke this function.</p> <p>IP Address - This is the IP address of the router. (Default: 192.168.1.1).</p> <p>Subnet Mask - The subnet mask, together with the IP Address field, indicates the maximum number of clients allowed on the subnet. (Default: 255.255.255.0/ 24).</p>
DHCP Server Configuration	<p>Disable - Let you manually assign IP address to every host in the LAN.</p> <p>Enable Server - Let the router assign IP address to every host in the LAN.</p> <ul style="list-style-type: none"> <li>Start IP Address - The beginning LAN IP address that is given out to LAN DHCP clients.</li> <li>IP Pool Counts - The maximum number of IP addresses to be handed out by DHCP. The default value is 100. Valid range is between 1 and 1021. The actual number of IP addresses available for assignment is the IP Pool Counts, or 1021 minus the last octet of the Start IP Address, whichever is smaller.</li> <li>Gateway IP Address - The IP address of the gateway, which is the host on the LAN that relays all traffic coming into and going out of the LAN. The gateway is normally the router, and therefore the Gateway IP Address should be identical to the IP Address in the Network Configuration section above.</li> </ul>

	<ul style="list-style-type: none"> <li>● Lease Time - The maximum duration DHCP-issued IP addresses can be used before they have to be renewed.</li> <li>● Clear DHCP lease for inactive clients periodically - If selected, the router sends ARP requests recycles IP addresses previously assigned to inactive DHCP clients to prevent exhaustion of the IP address pool.</li> </ul> <p>Note: When Clear DHCP lease for inactive clients periodically is enabled, router will do the following:</p> <ul style="list-style-type: none"> <li>- Check activities of DHCP clients by ARP requests every minute when the available DHCP IP addresses are less than 30</li> <li>- Clear DHCP lease when the client is not responding ARP replies.</li> </ul> <p>Enable Relay Agent - When selected, all DHCP requests are forwarded to a DHCP server outside of the LAN subnet, and whose address is specified in the DHCP Server IP Address field.</p> <ul style="list-style-type: none"> <li>● DHCP Server IP Address - It is available when Enable Relay Agent is checked. Set the IP address of the DHCP server you are going to use so the Relay Agent can help to forward the DHCP request to the DHCP server.</li> </ul>																				
DNS Server IP Address	<p>DNS stands for Domain Name System. Every Internet host must have a unique IP address, also they may have a human-friendly, easy to remember name such as www.yahoo.com. The DNS server converts the user-friendly name into its equivalent IP address.</p> <p>Primary IP Address -You must specify a DNS server IP address here because your ISP should provide you with usually more than one DNS Server.</p> <p>Secondary IP Address - You can specify secondary DNS server IP address here because your ISP often provides you more than one DNS Server.</p> <p>The default DNS Server IP address can be found via Online Status:</p> <div data-bbox="699 1350 1396 1512" style="border: 1px solid #ccc; padding: 5px;"> <p>Online Status</p> <hr/> <p>Physical Connection <span style="float: right;">System Uptime: 22:22:45</span></p> <table border="1" style="width: 100%; border-collapse: collapse;"> <thead> <tr> <th colspan="2">IPv4</th> <th colspan="2">IPv6</th> </tr> </thead> <tbody> <tr> <td colspan="2">LAN Status</td> <td colspan="2">Primary DNS: 8.8.8.8</td> </tr> <tr> <td colspan="2"></td> <td colspan="2">Secondary DNS: 8.8.4.4</td> </tr> <tr> <td>IP Address</td> <td>TX Packets</td> <td colspan="2">RX Packets</td> </tr> <tr> <td>192.168.1.1</td> <td>0</td> <td colspan="2">41533</td> </tr> </tbody> </table> </div> <p>If both the Primary IP and Secondary IP Address fields are left empty, the router will assign its own IP address to local users as a DNS proxy server and maintain a DNS cache.</p> <p>If the IP address of a domain name is already in the DNS cache, the router will resolve the domain name immediately. Otherwise, the router forwards the DNS query packet to the external DNS server by establishing a WAN (e.g. DSL/Cable) connection.</p>	IPv4		IPv6		LAN Status		Primary DNS: 8.8.8.8				Secondary DNS: 8.8.4.4		IP Address	TX Packets	RX Packets		192.168.1.1	0	41533	
IPv4		IPv6																			
LAN Status		Primary DNS: 8.8.8.8																			
		Secondary DNS: 8.8.4.4																			
IP Address	TX Packets	RX Packets																			
192.168.1.1	0	41533																			

When you finish the configuration, please click OK to save and exit this page.

## II-2-1-3 Details Page for IP Routed Subnet

LAN >> General Setup

**TCP/IP and DHCP Setup for IP Routed Subnet**

<p><b>Network Configuration</b></p> <p><input type="radio"/> Enable      <input checked="" type="radio"/> Disable</p> <p>For Routing Usage</p> <p>IP Address: <input type="text" value="192.168.0.1"/></p> <p>Subnet Mask: <input type="text" value="255.255.255.0 / 24"/></p> <hr/> <p>RIP Protocol Control: <input type="text" value="Disable"/></p>	<p><b>DHCP Server Configuration</b></p> <p>Start IP Address: <input type="text"/></p> <p>IP Pool Counts: <input type="text" value="0"/> (max. 32)</p> <p>Lease Time: <input type="text" value="259200"/> (s)</p> <p><input type="checkbox"/> Use LAN Port      <input checked="" type="checkbox"/> P1    <input checked="" type="checkbox"/> P2</p> <p><input checked="" type="checkbox"/> Use MAC Address</p> <hr/> <table border="1"> <thead> <tr> <th>Index</th> <th>Matched MAC Address</th> <th>given IP Address</th> </tr> </thead> <tbody> <tr> <td colspan="3" style="height: 50px;"> </td> </tr> </tbody> </table> <p>MAC Address: <input type="text" value="FF:FF:FF:FF:FF:FF"/></p> <p><input type="button" value="Add"/>   <input type="button" value="Delete"/>   <input type="button" value="Edit"/>   <input type="button" value="Cancel"/></p>	Index	Matched MAC Address	given IP Address			
Index	Matched MAC Address	given IP Address					

Available settings are explained as follows:

Item	Description
Network Configuration	<p>Enable/Disable - Click Enable to enable such configuration; click Disable to disable such configuration.</p> <p>For Routing Usage,</p> <p>IP Address - This is the IP address of the router. (Default: 192.168.1.1).</p> <p>Subnet Mask - The subnet mask, together with the IP Address field, indicates the maximum number of clients allowed on the subnet. (Default: 255.255.255.0/ 24).</p> <p>RIP Protocol Control,</p> <p>Enable - When Enabled, the router will attempt to exchange routing information with neighbouring routers using the Routing Information Protocol.</p>
DHCP Server Configuration	<p>DHCP stands for Dynamic Host Configuration Protocol. The router by factory default acts a DHCP server for your network so it automatically dispatch related IP settings to any local user configured as a DHCP client. It is highly recommended that you leave the router enabled as a DHCP server if you do not have a DHCP server for your network.</p> <p>Start IP Address - Enter a value of the IP address pool for the DHCP server to start with when issuing IP addresses. If the 1st IP address of your router is 192.168.1.1, the starting IP address must be 192.168.1.2 or greater, but smaller than 192.168.1.254.</p> <p>IP Pool Counts - Enter the maximum number of PCs that you want the DHCP server to assign IP addresses to. The default is 50 and the maximum is 253.</p> <p>Lease Time - Enter the time to determine how long the IP</p>

---

address assigned by DHCP server can be used.

Use LAN Port - Specify an IP for IP Route Subnet. If it is enabled, DHCP server will assign IP address automatically for the clients coming from P1 and/or P2. Please check the box of P1 and P2.

Use MAC Address - Check such box to specify MAC address.

- MAC Address - Enter the MAC Address of the host one by one and click Add to create a list of hosts which can be assigned, deleted or edited from above pool. Set a list of MAC Address for 2<sup>nd</sup> DHCP server will help router to assign the correct IP address of the correct subnet to the correct host. So those hosts in 2<sup>nd</sup> subnet won't get an IP address belonging to 1<sup>st</sup> subnet.

Add - Enter the MAC address in the boxes and click this button to add.

Delete - Click it to delete the selected MAC address.

Edit - Click it to edit the selected MAC address.

Cancel - Click it to cancel the job of adding, deleting and editing.

---

When you finish the configuration, please click OK to save and exit this page.



## II-2-1-4 Details Page for LAN IPv6 Setup

There are two configuration pages for LAN1/LAN2/LAN3/LAN4/LAN5/LAN6/LAN7/LAN8/DMZ Port, Ethernet TCP/IP and DHCP Setup (based on IPv4) and IPv6 Setup. Click the tab for each type and refer to the following explanations for detailed information. Below shows the settings page for IPv6.

LAN >> General Setup

LAN1 Ethernet TCP / IP and DHCP Setup
LAN 1 IPv6 Setup

Enable IPv6

WAN Primary Interface WAN1

**Static IPv6 Address**

IPv6 Address  / Prefix Length

**Unique Local Address(ULA) configuration**

Off :: / 64

**Current IPv6 Address Table**

Index	IPv6 Address/Prefix Length	Scope
1	FE80::1649:BCFF:FE11:7B60/64	Link

**DNS Server IPv6 Address** Deploy when WAN is up

Use DNS Server (WAN/Custom) Both

Primary DNS Server 2001:4860:4860::8888

Secondary DNS Server 2001:4860:4860::8844

**Management** SLAAC(stateless)

Other Option(O-bit)

**DHCPv6 Server**

Enable Server  Disable Server

IPv6 Address Random Allocation

Auto IPv6 range

Start IPv6 Address ::

End IPv6 Address ::

Advance setting

Advance setting

It provides 2 daemons for LAN side IPv6 address configuration. One is SLAAC(stateless) and the other is DHCPv6 (Stateful) server.

Available settings are explained as follows:

Item	Description
Enable	Check the box to enable the configuration of LAN 1 IPv6 Setup.
WAN Primary Interface	Use the drop down list to specify a WAN interface for IPv6.
Static IPv6 Address configuration	IPv6 Address -Type static IPv6 address for LAN. Prefix Length - Enter the fixed value for prefix length. Add - Click it to add a new entry.

	Delete - Click it to remove an existed entry.
Unique Local Address (ULA) configuration	<p>Unique Local Addresses (ULAs) are private IPv6 addresses assigned to LAN clients.</p> <p>Off - ULA is disabled.</p> <p>Manually ULA Prefix - LAN clients will be assigned ULAs generated based on the prefix manually entered.</p> <p>Auto ULA Prefix - LAN clients will be assigned ULAs using an automatically-determined prefix.</p>
Current IPv6 Address Table	Display current used IPv6 addresses.
DNS Server IPv6 Address	<p>Deploy when WAN is up - The RA (router advertisement) packets will be sent to LAN PC with DNS server information only when network connection by any one of WAN interfaces is up.</p> <p>Enable - The RA (router advertisement) packets will be sent to LAN PC with DNS server information no matter WAN connection is up or not.</p> <p>Use DNS Server (WAN/Custom) - Determines the DNS server for sending the packets through WAN DNS Server, Customized DNS Server or both servers. The default setting is Both.</p> <p>If WAN DNS Server is selected, LAN client can visit the Internet through the dynamic DNS server offered by the ISP for data transmission. However,</p> <p>if Customized DNS Server is selected, LAN client can visit the Internet via the primary/secondary DNS server. Please specify settings for primary/secondary DNS server or use the default values.</p> <p>When Both is chosen, LAN client can visit the Internet either via the dynamic DNS server or the customized DNS servers.</p> <ul style="list-style-type: none"> <li>● Primary DNS Server - Enter the IPv6 address for Primary DNS server.</li> <li>● Secondary DNS Server - Enter another IPv6 address for DNS server if required.</li> </ul> <p>Disable - DNS server will not be used.</p>
Management	<p>Configures the Managed Address Configuration flag (M-bit) in Route Advertisements.</p> <ul style="list-style-type: none"> <li>● Off - No configuration information is sent using Route Advertisements.</li> <li>● SLAAC(stateless) - M-bit is unset.</li> <li>● DHCPv6(stateful) - M-bit is set, which indicates to LAN clients that they should acquire all IPv6 configuration information from a DHCPv6 server. The DHCPv6 server can either be the one built into the Vigor2927, or a separate DHCPv6 server.</li> </ul> <p>Other Option (O-bit) - Check this box to enable the O-bit for obtaining additional information (e.g., DNS) from DHCPv6.</p>
DHCPv6 Server	<p>Enable Server -Click it to enable DHCPv6 server. DHCPv6 Server could assign IPv6 address to PC according to the Start/End IPv6 address configuration.</p> <p>Disable Server -Click it to disable DHCPv6 server.</p> <p>Auto IPv6 range - After check the box, Vigor router will assign the IPv6 range automatically.</p> <p>Start IPv6 Address / End IPv6 Address -Enter the start and</p>

end address for IPv6 server.

Advance setting - Click the Edit button to configure advanced IPv6 settings for DHCPv6 server.

LAN >> General Setup

**DHCPv6 Server**

Authentication Protocol: None

Prefix Delegation:  Enable  Disable

Prefix: /

**DHCPv6 Prefix Delegation**

New Prefix: [ ]:[ ]:[ ]:[ ]::/64

Suffix: [ ]:[ ]:[ ]:[ ]

New Prefix Length: [ ] (0~64)

Client Link Local Address: [ ]

Client DUID(option): [ ]

Add

Prefix	Prefix Length	Link Local	DUID
--------	---------------	------------	------

OK Cancel

Advance setting

The Advanced Settings page has additional settings for Router Advertisement and enabling multiple WANs for IPv6 traffic.

192.168.1.1/doc/enetedit.htm - Google Chrome

Router Advertisement Configuration

Enable  Disable

Hop Limit: 64

Min Interval Time(sec): 200

Max Interval Time(sec): 600

Default Lifetime(sec): 1800 (High Availability secondary is 0)

Default Preference: Medium

MTU: 0

RIPng Protocol

Enable

Extension WAN

Available WAN

Selected WAN

WAN2  
WAN3  
WAN4  
LTE  
WAN6

>> <<

Router Advertisement Configuration - Click Enable to enable router advertisement server. The router advertisement daemon sends Router Advertisement messages, specified by RFC 2461, to a local Ethernet LAN periodically and when requested by a node sending a Router Solicitation message. These messages are required for IPv6 stateless auto-configuration.

Disable - Click it to disable router advertisement server.

Hop Limit - The value is required for the device behind the router when IPv6 is in use.

Min/Max Interval Time (sec) - It defines the interval (between minimum time and maximum time) for sending RA (Router Advertisement) packets.

Default Lifetime (sec) - Within such period of time, Vigor router can be treated as the default gateway.

Default Preference - It determines the priority of the host

behind the router when RA (Router Advertisement) packets are transmitted.

MTU - It means Max Transmit Unit for packet. If Auto is selected, the router will determine the MTU value for LAN.

RIPng Protocol -RIPng (RIP next generation) offers the same functions and benefits as IPv4 RIP v2.

Extension WAN - In addition to the default WAN used for IPv6 traffic specified in the WAN Primary Interface in the LAN IPv6 Setup page, additional WANs can be selected to carry IPv6 traffic by enabling them in the Extension WAN section.

Available WAN - Additional WANs available but not currently selected to carry IPv6 traffic.

Selected WAN - Additional WANs selected to carry IPv6 traffic.

After making changes on the Advance setting page, click the OK button to retain the changes and return to the LAN IPv6 Setup page. Be sure to click OK on the LAN IPv6 Setup page or else changes made on the Advance setting page will not be saved.

### II-2-1-5 DHCP Server Options

DHCP Options can be configured by clicking the DHCP Server Option button on the LAN>> General Setup screen.

LAN >> General Setup

---

DHCP Server Customized Status

**IPv4**      **IPv6**      [Set to Factory Default](#)

5 entries per page

**Customized List**

Enable	Interface	Option	Type	Data
Enable: <input checked="" type="checkbox"/>	All <input type="checkbox"/> LAN1 <input type="checkbox"/> LAN2 <input type="checkbox"/> LAN3 <input type="checkbox"/> LAN4 <input type="checkbox"/> LAN5 <input type="checkbox"/> LAN6 <input type="checkbox"/> LAN7 <input type="checkbox"/> LAN8 <input type="checkbox"/> DMZ <input type="checkbox"/> IP Routed Subnet <input type="checkbox"/>	Next Server IP Address/SlAddr: <input type="text"/>	Option Number: <input type="text"/>	DataType: <input checked="" type="radio"/> ASCII Character (EX :Option:18, Data:/path) <input type="radio"/> Hexadecimal Digit (Please check note 4.) <input type="radio"/> Address List (EX :Option:44, Data:172.16.2.10,172.16.2.20...)
Data: <input type="text" value="Max 127 characters"/>				
<input type="button" value="Add"/> <input type="button" value="Update"/> <input type="button" value="Delete"/> <input type="button" value="Reset"/>				

**Note:**

1. Configuring options 44, 46 or 66 here will overwrite the settings by telnet command msubnet.
2. Configuring option 3 here will overwrite the setting in "LAN >> General Setup" Details Page's "Gateway IP Address" field.
3. Configuring option 15 here will overwrite the setting in "WAN >> Internet Access >> Static or Dynamic IP" Detail Page's "Domain Name" field.
4. Hexadecimal Digit: Input the hexadecimal representation of ASCII Character data. EX: Option:18, Data:2f70617468 (/path)

Available settings are explained as follows:

Item	Description
Customized List	Shows all the DHCP options that have been configured in the system.

Enable	If selected, DHCP option entry is enabled. If unselected, DHCP option entry is disabled.
Interface	LAN interface(s) to which this entry is applicable.
Next Server IP Address/SIAddr	Overrides the DHCP Next Server IP address (DHCP Option 66) supplied by the DHCP server.
Option Number	DHCP option number (e.g., 100).
Data Type	Type of data in the Data field: ASCII Character - A text string. Example: /path. Hexadecimal Digit - A hexadecimal string. Valid characters are from 0 to 9 and from a to f. Example: 2f70617468. Address List - One or more IPv4 addresses, delimited by commas.
Data	Data of this DHCP option.

To add a DHCP option entry from scratch, clear the data entry fields (Enable, Interface, Option Number, Data Type and Data) by clicking Reset. After filling in the values, click Add to create the new entry.

To add a DHCP option entry modeled after an existing entry, click the model entry in Customized List. The data entry fields will be populated with values from the model entry. After making all necessary changes for the new entry, click Add to create it.

To modify an existing DHCP option entry, click on it in Customized List. The data entry fields will be populated with the current values from the entry. After making all necessary changes, click Update to save the changes.

To delete a DHCP option entry, click on it in Customized List, and then click Delete.

## II-2-2 VLAN

Virtual Local Area Networks (VLANs) allow you to subdivide your LAN to facilitate management or to improve network security.

Select LAN>>VLAN from the menu bar of the Web UI to bring up the VLAN Configuration page.

### Tagged VLAN

The tagged VLANs (802.1q) can mark data with a VLAN identifier. This identifier can be carried through an onward Ethernet switch to specific ports. The specific VLAN clients can also pick up this identifier as it is just passed to the LAN. You can set the priorities for LAN-side QoS. You can assign each of VLANs to each of the different IP subnets that the router may also be operating, to provide even more isolation. The said functionality is tag-based multi-subnet.

### Port-Based VLAN

Relative to tag-based VLAN which groups clients with an identifier, port-based VLAN uses physical ports (P1 ~ P4) to separate the clients into different VLAN group.

Virtual LAN function provides you a very convenient way to manage hosts by grouping them based on the physical port. The multi-subnet can let a small businesses have much better isolation for multi-occupancy applications. Go to LAN page and select VLAN. The following page will appear. Click Enable to invoke VLAN function.

Below is an example page in Vigor2927ac:

LAN >> VLAN Configuration ?

---

**VLAN Configuration**

Enable

	LAN					Wireless LAN(2.4GHz)				Wireless LAN(5GHz)				Subnet	VLAN Tag		
	P1	P2	P3	P4	P5	SSID1	SSID2	SSID3	SSID4	SSID1	SSID2	SSID3	SSID4		Enable	VID	Priority
VLAN0	<input type="checkbox"/>	<input type="checkbox"/>	<input type="checkbox"/>	<input type="checkbox"/>	<input type="checkbox"/>	<input type="checkbox"/>	<input type="checkbox"/>	<input type="checkbox"/>	<input type="checkbox"/>	<input type="checkbox"/>	<input type="checkbox"/>	<input type="checkbox"/>	<input type="checkbox"/>	LAN 1 ▾	<input type="checkbox"/>	0	0 ▾
VLAN1	<input type="checkbox"/>	<input type="checkbox"/>	<input type="checkbox"/>	<input type="checkbox"/>	<input type="checkbox"/>	<input type="checkbox"/>	<input type="checkbox"/>	<input type="checkbox"/>	<input type="checkbox"/>	<input type="checkbox"/>	<input type="checkbox"/>	<input type="checkbox"/>	<input type="checkbox"/>	LAN 1 ▾	<input type="checkbox"/>	0	0 ▾
VLAN2	<input type="checkbox"/>	<input type="checkbox"/>	<input type="checkbox"/>	<input type="checkbox"/>	<input type="checkbox"/>	<input type="checkbox"/>	<input type="checkbox"/>	<input type="checkbox"/>	<input type="checkbox"/>	<input type="checkbox"/>	<input type="checkbox"/>	<input type="checkbox"/>	<input type="checkbox"/>	LAN 1 ▾	<input type="checkbox"/>	0	0 ▾
VLAN3	<input type="checkbox"/>	<input type="checkbox"/>	<input type="checkbox"/>	<input type="checkbox"/>	<input type="checkbox"/>	<input type="checkbox"/>	<input type="checkbox"/>	<input type="checkbox"/>	<input type="checkbox"/>	<input type="checkbox"/>	<input type="checkbox"/>	<input type="checkbox"/>	<input type="checkbox"/>	LAN 1 ▾	<input type="checkbox"/>	0	0 ▾
VLAN4	<input type="checkbox"/>	<input type="checkbox"/>	<input type="checkbox"/>	<input type="checkbox"/>	<input type="checkbox"/>	<input type="checkbox"/>	<input type="checkbox"/>	<input type="checkbox"/>	<input type="checkbox"/>	<input type="checkbox"/>	<input type="checkbox"/>	<input type="checkbox"/>	<input type="checkbox"/>	LAN 1 ▾	<input type="checkbox"/>	0	0 ▾
VLAN5	<input type="checkbox"/>	<input type="checkbox"/>	<input type="checkbox"/>	<input type="checkbox"/>	<input type="checkbox"/>	<input type="checkbox"/>	<input type="checkbox"/>	<input type="checkbox"/>	<input type="checkbox"/>	<input type="checkbox"/>	<input type="checkbox"/>	<input type="checkbox"/>	<input type="checkbox"/>	LAN 1 ▾	<input type="checkbox"/>	0	0 ▾
VLAN6	<input type="checkbox"/>	<input type="checkbox"/>	<input type="checkbox"/>	<input type="checkbox"/>	<input type="checkbox"/>	<input type="checkbox"/>	<input type="checkbox"/>	<input type="checkbox"/>	<input type="checkbox"/>	<input type="checkbox"/>	<input type="checkbox"/>	<input type="checkbox"/>	<input type="checkbox"/>	LAN 1 ▾	<input type="checkbox"/>	0	0 ▾
VLAN7	<input type="checkbox"/>	<input type="checkbox"/>	<input type="checkbox"/>	<input type="checkbox"/>	<input type="checkbox"/>	<input type="checkbox"/>	<input type="checkbox"/>	<input type="checkbox"/>	<input type="checkbox"/>	<input type="checkbox"/>	<input type="checkbox"/>	<input type="checkbox"/>	<input type="checkbox"/>	LAN 1 ▾	<input type="checkbox"/>	0	0 ▾
VLAN8	<input type="checkbox"/>	<input type="checkbox"/>	<input type="checkbox"/>	<input type="checkbox"/>	<input type="checkbox"/>	<input type="checkbox"/>	<input type="checkbox"/>	<input type="checkbox"/>	<input type="checkbox"/>	<input type="checkbox"/>	<input type="checkbox"/>	<input type="checkbox"/>	<input type="checkbox"/>	LAN 1 ▾	<input type="checkbox"/>	0	0 ▾
VLAN9	<input type="checkbox"/>	<input type="checkbox"/>	<input type="checkbox"/>	<input type="checkbox"/>	<input type="checkbox"/>	<input type="checkbox"/>	<input type="checkbox"/>	<input type="checkbox"/>	<input type="checkbox"/>	<input type="checkbox"/>	<input type="checkbox"/>	<input type="checkbox"/>	<input type="checkbox"/>	LAN 1 ▾	<input type="checkbox"/>	0	0 ▾
VLAN10	<input type="checkbox"/>	<input type="checkbox"/>	<input type="checkbox"/>	<input type="checkbox"/>	<input type="checkbox"/>	<input type="checkbox"/>	<input type="checkbox"/>	<input type="checkbox"/>	<input type="checkbox"/>	<input type="checkbox"/>	<input type="checkbox"/>	<input type="checkbox"/>	<input type="checkbox"/>	LAN 1 ▾	<input type="checkbox"/>	0	0 ▾
VLAN11	<input type="checkbox"/>	<input type="checkbox"/>	<input type="checkbox"/>	<input type="checkbox"/>	<input type="checkbox"/>	<input type="checkbox"/>	<input type="checkbox"/>	<input type="checkbox"/>	<input type="checkbox"/>	<input type="checkbox"/>	<input type="checkbox"/>	<input type="checkbox"/>	<input type="checkbox"/>	LAN 1 ▾	<input type="checkbox"/>	0	0 ▾
VLAN12	<input type="checkbox"/>	<input type="checkbox"/>	<input type="checkbox"/>	<input type="checkbox"/>	<input type="checkbox"/>	<input type="checkbox"/>	<input type="checkbox"/>	<input type="checkbox"/>	<input type="checkbox"/>	<input type="checkbox"/>	<input type="checkbox"/>	<input type="checkbox"/>	<input type="checkbox"/>	LAN 1 ▾	<input type="checkbox"/>	0	0 ▾
VLAN13	<input type="checkbox"/>	<input type="checkbox"/>	<input type="checkbox"/>	<input type="checkbox"/>	<input type="checkbox"/>	<input type="checkbox"/>	<input type="checkbox"/>	<input type="checkbox"/>	<input type="checkbox"/>	<input type="checkbox"/>	<input type="checkbox"/>	<input type="checkbox"/>	<input type="checkbox"/>	LAN 1 ▾	<input type="checkbox"/>	0	0 ▾
VLAN14	<input type="checkbox"/>	<input type="checkbox"/>	<input type="checkbox"/>	<input type="checkbox"/>	<input type="checkbox"/>	<input type="checkbox"/>	<input type="checkbox"/>	<input type="checkbox"/>	<input type="checkbox"/>	<input type="checkbox"/>	<input type="checkbox"/>	<input type="checkbox"/>	<input type="checkbox"/>	LAN 1 ▾	<input type="checkbox"/>	0	0 ▾
VLAN15	<input type="checkbox"/>	<input type="checkbox"/>	<input type="checkbox"/>	<input type="checkbox"/>	<input type="checkbox"/>	<input type="checkbox"/>	<input type="checkbox"/>	<input type="checkbox"/>	<input type="checkbox"/>	<input type="checkbox"/>	<input type="checkbox"/>	<input type="checkbox"/>	<input type="checkbox"/>	LAN 1 ▾	<input type="checkbox"/>	0	0 ▾

Permit untagged device in P1 to access router

**Note:**

1. For each VLAN row, selecting Enable VLAN Tag will apply the associated VID to the selected wired LAN port.
2. Wireless LAN traffic is always untagged, but the SSID is still a member of the selected VLAN (group).
3. Each VID must be unique.



---

**Info** Settings in this page only applied to LAN port but not WAN port.

---

Available settings are explained as follows:

Item	Description
Enable	Click it to enable VLAN configuration.
LAN	P1 - P5 - Check the LAN port(s) to group them under the selected VLAN.
Wireless LAN (2.4GHz)	SSID1 - SSID4 - Check the SSID boxes to group them under the selected VLAN.
Wireless LAN (5GHz)	SSID1 - SSID4 - Check the SSID boxes to group them under the selected VLAN.
Subnet	Choose one of them to make the selected VLAN mapping to the specified subnet only. For example, LAN1 is specified for VLAN0. It means that PCs grouped under VLAN0 can get the IP address(es) that specified by the subnet.
VLAN Tag	Enable - Check the box to enable the function of VLAN with tag.  The router will add specific VLAN number to all packets on the LAN while sending them out.  Please Enter the tag value and specify the priority for the packets sending by LAN.  VID - Enter the value as the VLAN ID number. The range is form 0 to 4095. VIDs must be unique.  Priority - Valid values are from 0 to 7, where 1 has the lowest priority, followed by 0, and finally from 2 to 7 in increasing order of priority.
Permit untagged device in P1 to access router	Select to allow untagged hosts connected to LAN port P1 to access the router. In case you have incorrectly configured VLAN functionality, you will still be able to access the router via the Web UI, and telnet and SSH shells to adjust the configuration.



---

**Info** Leave one VLAN untagged at least to prevent from not connecting to Vigor router due to unexpected error.

---

### Inter-LAN Routing

The Vigor router supports up to 15 VLANs. Each VLAN can be set up to use one or more of the Ethernet ports and wireless LAN Service Set Identifiers (SSIDs). Within the grid of VLANs (horizontal rows) and LAN interfaces (vertical columns),

- all hosts within the same VLAN (horizontal row) are visible to one another
- all hosts connected to the same LAN or WLAN interface (vertical column) are visible to one another if
  - they belong to the same VLAN, or
  - they belong to different VLANs, and inter-LAN routing (LAN>>General Setup) between them is enabled (see below).

### Inter-LAN Routing

Subnet	LAN 1	LAN 2	LAN 3	LAN 4	LAN 5	LAN 6	LAN 7	LAN 8	DMZ Port
LAN 1	<input checked="" type="checkbox"/>	<input type="checkbox"/>	<input type="checkbox"/>	<input type="checkbox"/>	<input type="checkbox"/>	<input type="checkbox"/>	<input type="checkbox"/>	<input type="checkbox"/>	<input type="checkbox"/>
LAN 2	<input checked="" type="checkbox"/>	<input checked="" type="checkbox"/>	<input type="checkbox"/>	<input type="checkbox"/>	<input type="checkbox"/>	<input type="checkbox"/>	<input type="checkbox"/>	<input type="checkbox"/>	<input type="checkbox"/>
LAN 3	<input checked="" type="checkbox"/>	<input type="checkbox"/>	<input checked="" type="checkbox"/>	<input type="checkbox"/>	<input type="checkbox"/>	<input type="checkbox"/>	<input type="checkbox"/>	<input type="checkbox"/>	<input type="checkbox"/>
LAN 4	<input checked="" type="checkbox"/>	<input type="checkbox"/>	<input type="checkbox"/>	<input checked="" type="checkbox"/>	<input type="checkbox"/>	<input type="checkbox"/>	<input type="checkbox"/>	<input type="checkbox"/>	<input type="checkbox"/>
LAN 5	<input type="checkbox"/>	<input type="checkbox"/>	<input type="checkbox"/>	<input type="checkbox"/>	<input checked="" type="checkbox"/>	<input type="checkbox"/>	<input type="checkbox"/>	<input type="checkbox"/>	<input type="checkbox"/>
LAN 6	<input type="checkbox"/>	<input type="checkbox"/>	<input type="checkbox"/>	<input type="checkbox"/>	<input type="checkbox"/>	<input checked="" type="checkbox"/>	<input type="checkbox"/>	<input type="checkbox"/>	<input type="checkbox"/>
LAN 7	<input type="checkbox"/>	<input type="checkbox"/>	<input type="checkbox"/>	<input type="checkbox"/>	<input type="checkbox"/>	<input type="checkbox"/>	<input checked="" type="checkbox"/>	<input type="checkbox"/>	<input type="checkbox"/>
LAN 8	<input type="checkbox"/>	<input type="checkbox"/>	<input type="checkbox"/>	<input type="checkbox"/>	<input type="checkbox"/>	<input type="checkbox"/>	<input type="checkbox"/>	<input checked="" type="checkbox"/>	<input type="checkbox"/>
DMZ Port	<input type="checkbox"/>	<input type="checkbox"/>	<input type="checkbox"/>	<input type="checkbox"/>	<input type="checkbox"/>	<input type="checkbox"/>	<input type="checkbox"/>	<input type="checkbox"/>	<input checked="" type="checkbox"/>

Inter-LAN Routing allows different LAN subnets to be interconnected or isolated. It is only available when the VLAN functionality is enabled. In the Inter-LAN Routing matrix, a selected checkbox means that the 2 intersecting LANs can communicate with each other.

Vigor2927 series features a hugely flexible VLAN system. In its simplest form, each of the Gigabit LAN ports can be isolated from each other, for example to feed different companies or departments but keeping their local traffic completely separated.

### Configuring port-based VLAN for wireless and non-wireless clients

1. All the wire network clients are categorized to group VLAN0 in subnet 192.168.1.0/24 (LAN1).
2. All the wireless network clients are categorized to group VLAN1 in subnet 192.168.2.0/24 (LAN2).
3. Open LAN>>VLAN Configuration. Check the boxes according to the statement in step 1 and Step 2.

LAN >> VLAN Configuration ?

#### VLAN Configuration

	LAN					Wireless LAN(2.4GHz)				Wireless LAN(5GHz)				VLAN Tag			
	P1	P2	P3	P4	P5	SSID1	SSID2	SSID3	SSID4	SSID1	SSID2	SSID3	SSID4	Subnet	Enable	VID	Priority
VLAN0	<input checked="" type="checkbox"/>	<input checked="" type="checkbox"/>	<input checked="" type="checkbox"/>	<input checked="" type="checkbox"/>	<input checked="" type="checkbox"/>	<input type="checkbox"/>	<input type="checkbox"/>	<input type="checkbox"/>	<input type="checkbox"/>	<input type="checkbox"/>	<input type="checkbox"/>	<input type="checkbox"/>	<input type="checkbox"/>	LAN1	<input type="checkbox"/>	0	0
VLAN1	<input type="checkbox"/>	<input type="checkbox"/>	<input type="checkbox"/>	<input type="checkbox"/>	<input type="checkbox"/>	<input checked="" type="checkbox"/>	<input checked="" type="checkbox"/>	<input checked="" type="checkbox"/>	<input checked="" type="checkbox"/>	<input checked="" type="checkbox"/>	<input checked="" type="checkbox"/>	<input checked="" type="checkbox"/>	<input checked="" type="checkbox"/>	LAN2	<input checked="" type="checkbox"/>	20	0
VLAN2	<input type="checkbox"/>	<input type="checkbox"/>	<input type="checkbox"/>	<input type="checkbox"/>	<input type="checkbox"/>	<input type="checkbox"/>	<input type="checkbox"/>	<input type="checkbox"/>	<input type="checkbox"/>	<input type="checkbox"/>	<input type="checkbox"/>	<input type="checkbox"/>	<input type="checkbox"/>	LAN3	<input type="checkbox"/>	0	0
VLAN3	<input type="checkbox"/>	<input type="checkbox"/>	<input type="checkbox"/>	<input type="checkbox"/>	<input type="checkbox"/>	<input type="checkbox"/>	<input type="checkbox"/>	<input type="checkbox"/>	<input type="checkbox"/>	<input type="checkbox"/>	<input type="checkbox"/>	<input type="checkbox"/>	<input type="checkbox"/>	LAN4	<input type="checkbox"/>	0	0
VLAN4	<input type="checkbox"/>	<input type="checkbox"/>	<input type="checkbox"/>	<input type="checkbox"/>	<input type="checkbox"/>	<input type="checkbox"/>	<input type="checkbox"/>	<input type="checkbox"/>	<input type="checkbox"/>	<input type="checkbox"/>	<input type="checkbox"/>	<input type="checkbox"/>	<input type="checkbox"/>	LAN1	<input type="checkbox"/>	0	0
VLAN5	<input type="checkbox"/>	<input type="checkbox"/>	<input type="checkbox"/>	<input type="checkbox"/>	<input type="checkbox"/>	<input type="checkbox"/>	<input type="checkbox"/>	<input type="checkbox"/>	<input type="checkbox"/>	<input type="checkbox"/>	<input type="checkbox"/>	<input type="checkbox"/>	<input type="checkbox"/>	LAN1	<input type="checkbox"/>	0	0

4. Click OK.
5. Open LAN>>General Setup. If you want to let the clients in both groups communicate with each other, simply activate Inter-LAN Routing by checking the box between LAN1 and LAN2.



LAN >> General Setup

General Setup

Index	Enable	DHCP	DHCPv6	IP Address	Details Page	IPv6
LAN 1	V	V	V	192.168.27.1	Details Page	IPv6
LAN 2	<input checked="" type="checkbox"/>	<input checked="" type="checkbox"/>	<input checked="" type="checkbox"/>	192.168.20.1	Details Page	IPv6
LAN 3	<input type="checkbox"/>	<input checked="" type="checkbox"/>	<input checked="" type="checkbox"/>	192.168.3.1	Details Page	IPv6
LAN 4	<input type="checkbox"/>	<input checked="" type="checkbox"/>	<input checked="" type="checkbox"/>	192.168.4.1	Details Page	IPv6
LAN 5	<input type="checkbox"/>	<input checked="" type="checkbox"/>	<input checked="" type="checkbox"/>	192.168.5.1	Details Page	IPv6
LAN 6	<input type="checkbox"/>	<input checked="" type="checkbox"/>	<input checked="" type="checkbox"/>	192.168.6.1	Details Page	IPv6
LAN 7	<input type="checkbox"/>	<input checked="" type="checkbox"/>	<input checked="" type="checkbox"/>	192.168.7.1	Details Page	IPv6
LAN 8	<input type="checkbox"/>	<input checked="" type="checkbox"/>	<input checked="" type="checkbox"/>	192.168.8.1	Details Page	IPv6
DMZ Port	<input type="checkbox"/>	<input checked="" type="checkbox"/>	<input checked="" type="checkbox"/>	192.168.254.1	Details Page	IPv6
IP Routed Subnet	<input type="checkbox"/>	<input checked="" type="checkbox"/>		192.168.0.1	Details Page	

DHCP Server Option

Note:

1. Please enable LAN 2 - 8 on [LAN >> VLAN](#) page before configure them.
2. Enable DMZ port will make the LAN Port 5 neglect the setting on VLAN page, LAN Port 5 will become the DMZ Port.

Force router to use "DNS server IP address" settings specified in LAN1

Inter-LAN Routing

Subnet	LAN 1	LAN 2	LAN 3	LAN 4	LAN 5	LAN 6	LAN 7	LAN 8	DMZ Port
LAN 1	<input checked="" type="checkbox"/>	<input type="checkbox"/>	<input type="checkbox"/>	<input type="checkbox"/>	<input type="checkbox"/>	<input type="checkbox"/>	<input type="checkbox"/>	<input type="checkbox"/>	<input type="checkbox"/>
LAN 2	<input checked="" type="checkbox"/>	<input checked="" type="checkbox"/>	<input type="checkbox"/>	<input type="checkbox"/>	<input type="checkbox"/>	<input type="checkbox"/>	<input type="checkbox"/>	<input type="checkbox"/>	<input type="checkbox"/>
LAN 3	<input checked="" type="checkbox"/>	<input type="checkbox"/>	<input checked="" type="checkbox"/>	<input type="checkbox"/>	<input type="checkbox"/>	<input type="checkbox"/>	<input type="checkbox"/>	<input type="checkbox"/>	<input type="checkbox"/>
LAN 4	<input checked="" type="checkbox"/>	<input type="checkbox"/>	<input type="checkbox"/>	<input checked="" type="checkbox"/>	<input type="checkbox"/>	<input type="checkbox"/>	<input type="checkbox"/>	<input type="checkbox"/>	<input type="checkbox"/>
LAN 5	<input type="checkbox"/>	<input type="checkbox"/>	<input type="checkbox"/>	<input type="checkbox"/>	<input checked="" type="checkbox"/>	<input type="checkbox"/>	<input type="checkbox"/>	<input type="checkbox"/>	<input type="checkbox"/>
LAN 6	<input type="checkbox"/>	<input type="checkbox"/>	<input type="checkbox"/>	<input type="checkbox"/>	<input type="checkbox"/>	<input checked="" type="checkbox"/>	<input type="checkbox"/>	<input type="checkbox"/>	<input type="checkbox"/>
LAN 7	<input type="checkbox"/>	<input type="checkbox"/>	<input type="checkbox"/>	<input type="checkbox"/>	<input type="checkbox"/>	<input type="checkbox"/>	<input checked="" type="checkbox"/>	<input type="checkbox"/>	<input type="checkbox"/>
LAN 8	<input type="checkbox"/>	<input type="checkbox"/>	<input type="checkbox"/>	<input type="checkbox"/>	<input type="checkbox"/>	<input type="checkbox"/>	<input type="checkbox"/>	<input checked="" type="checkbox"/>	<input type="checkbox"/>
DMZ Port	<input type="checkbox"/>	<input type="checkbox"/>	<input type="checkbox"/>	<input type="checkbox"/>	<input type="checkbox"/>	<input type="checkbox"/>	<input type="checkbox"/>	<input type="checkbox"/>	<input checked="" type="checkbox"/>

OK

Vigor router supports up to six private IP subnets on LAN. Each can be independent (isolated) or common (able to communicate with each other). This is ideal for departmental or multi-occupancy applications.

## II-2-3 Bind IP to MAC

This function is used to bind the IP and MAC address in LAN to have a strengthening control in network. With the Bind IP to MAC feature you can reserve LAN IP addresses for LAN clients. Each reserved IP address is associated with a Media Access Control (MAC) address.

Click LAN and click Bind IP to MAC to open the setup page.

LAN >> Bind IP to MAC

**Bind IP to MAC**

Enable    Disable  
 Strict Bind  
 Apply Strict Bind to Subnet:

**ARP Table**      | [Select All](#) | [Sort](#) | [Refresh](#) | [Add/Update to IP Bind List](#)

IP Address	MAC Address	HOST ID
192.168.1.10	60-A4-4C-E6-5A-4F	A1000381
192.168.1.11	14-49-BC-42-6E-1E	
192.168.1.12	00-50-7F-F1-91-BC	
192.168.1.101	14-49-BC-14-C4-48	

Add/Update to IP Bind List:  
 IP Address:   
 MAC Address:  FF-FF-FF-FF-FF-FF  
 Comment:  Max: 12 characters  
     

---

**IP Bind List (Limit: 1024 entries)**      | [Select All](#) | [Sort](#)

Index	IP Address	MAC Address	HOST ID	Comment

---

Backup IP Bind List:      
 Upload From File:  未選擇任何檔案

**Note:**

1. IP-MAC binding presets DHCP Allocations.
2. If Strict Bind is enabled, unspecified LAN clients in the selected subnets cannot access the Internet.
3. Comment can not contain characters " and '.
4. MAC address can be separated by : or -. E.g., FF:FF:FF:FF:FF:FF or FF-FF-FF-FF-FF-FF

Available settings are explained as follows:

Item	Description
Enable	Click this radio button to invoke this function. However, IP/MAC which is not listed in IP Bind List also can connect to Internet.
Disable	Click this radio button to disable this function. All the settings on this page will be invalid.
Strict Bind	Check the box to block the connection of the IP/MAC which is not listed in IP Bind List. LAN clients will be assigned IP addresses according to the

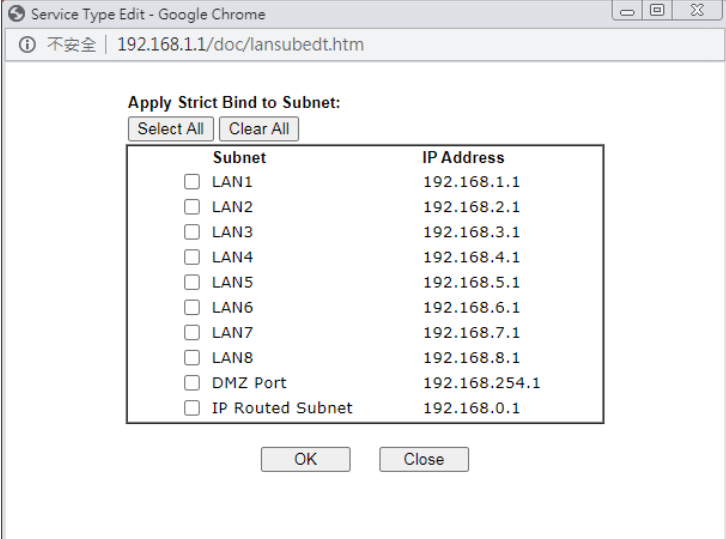
	<p>MAC-to-IP address associations on this page. LAN client whose MAC address has not been bound to an IP address will be denied network access.</p> <p>Note: Before selecting Strict Bind, make sure at least one valid MAC address has been bound to an IP address. Otherwise no LAN clients will have network access, and it will not be possible to connect to the router to make changes to its configuration.</p> <p>Apply Strict Bind to Subnet – Choose the subnet(s) for applying the rules of Bind IP to MAC.</p> 
ARP Table	This table is the LAN ARP table of this router. The information for IP and MAC will be displayed in this field. Each pair of IP and MAC address listed in ARP table can be selected and added to IP Bind List by clicking Add below.
Select All	Select all entries in the ARP Table for manipulation.
Sort	Reorder the entry based on the IP address.
Refresh	Refresh the ARP table listed below to obtain the newest ARP table information.
Add or Update to IP Bind List	<p>IP Address – Enter the IP address to be associated with a MAC address.</p> <p>Mac Address – Enter the MAC address of the LAN client’s network interface.</p> <p>Comment – Type a brief description for the entry.</p>
Add	It allows you to add the one you choose from the ARP table or the IP/MAC address typed in Add and Edit to the table of IP Bind List.
Update	It allows you to edit and modify the selected IP address and MAC address that you create before.
Delete	You can remove any item listed in IP Bind List. Simply click and select the one, and click Delete. The selected item will be removed from the IP Bind List.
IP Bind List	It displays a list for the IP bind to MAC information.
Backup IP Bind List	Click Backup and enter a filename to back up IP Bind List to a file.
Upload From File	Click Browse... to select an IP Bind List backup file. Click

---

	Restore to restore the backup and overwrite the existing list.
--	--

---



---

**Info**

Before you select Strict Bind, you have to bind one set of IP/MAC address for one PC. If not, no one of the PCs can access into Internet. And the web user interface of the router might not be accessed.

---

When you finish the configuration, click OK to save the settings.

## II-2-4 LAN Port Mirror

The LAN Port Mirror function allows network traffic of select LAN ports to be forwarded to another LAN port for analysis. This is useful for enforcing policies, detecting unauthorized access, monitoring network performance, etc.

Select LAN>>LAN Port Mirror from the menu bar of the Web UI to bring up the LAN Port Mirror configuration page.

LAN >> LAN Port Mirror

### LAN Port Mirror

Port Mirror: <input type="radio"/> Enable <input checked="" type="radio"/> Disable							
	<b>Port1</b>	<b>Port2</b>	<b>Port3</b>	<b>Port4</b>	<b>Port5</b>	<b>WAN1</b>	<b>WAN2</b>
<b>Mirror Port</b>	<input type="radio"/>	<input type="radio"/>	<input type="radio"/>	<input type="radio"/>	<input type="radio"/>	<input type="radio"/>	<input type="radio"/>
<b>Mirrored Tx Port</b>	<input type="checkbox"/>	<input type="checkbox"/>	<input type="checkbox"/>	<input type="checkbox"/>	<input type="checkbox"/>	<input type="checkbox"/>	<input type="checkbox"/>
<b>Mirrored Rx Port</b>	<input type="checkbox"/>	<input type="checkbox"/>	<input type="checkbox"/>	<input type="checkbox"/>	<input type="checkbox"/>	<input type="checkbox"/>	<input type="checkbox"/>

**Note:** The mirrored WAN1 is a software mirror, it will lead to a substantial decline in performance.

OK

Available settings are explained as follows:

Item	Description
Port Mirror	Enables or disables LAN Port Mirroring.
Mirror Port	One and only one port is selected as the mirror port, to which traffic is to be forwarded.
Mirrored Tx Port	Port(s) whose outbound traffic will be forwarded to the mirror port.
Mirrored Rx Port	Port(s) whose inbound traffic will be forwarded to the mirror port.

After finishing all the settings here, please click OK to save the configuration.

---

## II-2-5 Wired 802.1x

Wired 802.1X provides authentication for clients wishing to connect to the LAN by Ethernet. Only one client can be authenticated on each LAN port.

Select LAN>>Wired 802.1X from the menu bar of the Web UI to bring up the Wired 802.1X configuration page.

LAN >> Wired 802.1X

---

### Wired 802.1X

LAN 802.1X: <input type="checkbox"/> Enable Authentication Type: External RADIUS ▾ 802.1X ports: <input type="checkbox"/> P1 <input type="checkbox"/> P2 <input type="checkbox"/> P3 <input type="checkbox"/> P4 <input type="checkbox"/> P5
--

**Note:**

1. 802.1X enabled LAN ports only support a single attached device using EAPOL authentication. To authenticate multiple devices through a LAN port you need an 802.1X-capable switch. Then configure 802.1X on the attached switch instead.
2. Please configure [External RADIUS](#) or [Local 802.1X](#) for authentication.
3. Authentication by External RADIUS supports PEAP, EAP-TLS and EAP-TTLS.

OK

Available settings are explained as follows:

Item	Description
Enable	Check the box to enable LAN 802.1x function.
Authentication Type	External RADIUS - An external RADIUS server is to be used for 802.1X authentication. Go to Applications >> RADIUS / TACACS+>>External RADIUS to specify the RADIUS server. Local 802.1X - Use the user database on the router to authenticate clients. Go to User Management >> User Profile to set up users by entering user names, passwords and ensure that Local 802.1X service is enabled for the profiles.
802.1X ports	802.1X authentication will be available for the selected LAN ports.



After finishing all the settings here, please click OK to save the configuration.

## II-2-6 Link Aggregation

LAG means Link Aggregation Group which groups some physical ports together to make a single high-bandwidth data path. Thus it can implement traffic load sharing among the member ports in a group to enhance the connection reliability.

LAN >> Link Aggregation

### Link Aggregation

	Aggregation Ports				Link Status		
	Enable	P2	P3	P4	P5		
LAG1	<input type="checkbox"/>	<input type="checkbox"/>	<input type="checkbox"/>				

#### Notes:

1. Only Support Static (Balance-xor) mode
2. Ports in LAG can not be mirror port
3. LAG uses Hash Algorithm to decide the port, and the calculated port might be the same. When LAG doesn't work as expected, please change the device IP for a try.

OK

Available settings are explained as follows:

Item	Description
Enable	Check the box to enable LAN 802.1x function.
Aggregation Ports	Select the port number (at least two ports) to make a high-bandwidth data path. At present, the available ports to be selected include P2 and P3.
Link Status	Green light means the LAG port is connected by Ethernet cable(s).

After finishing all the settings here, please click OK to save the configuration.

## II-3 Hardware Acceleration

Hardware Acceleration is also called PPA in DrayTek for it is based on Protocol Processing Engine (PPE) of Infineon. It can only support 4096 sessions for network traffic (IN & OUT).

When the data traffic is heavy and data transmission is getting slowly and slowly, you can configure this page to accelerate the data streaming by hardware itself. Open Hardware Acceleration to access into the following page:

Hardware Acceleration >> Setup

Acceleration:  ▾

NAT

Protocol:  TCP  UDP

IPsec

Protocol:  TCP  UDP

Exception List

Max. 128 entries | [Refresh](#) |

Index	MAC Address	NAT	IPsec	Description

MAC Address :  :  :  :  :  :

Exception Type :  NAT  IPsec

Description :

**Note:**

Hardware Acceleration does not support PPTP/L2TP.

Available settings are explained as follows:

Item	Description
Acceleration	Disable - The default setting. Enable - Choose to enable the hardware acceleration function.
NAT	Select TCP and/or UDP.
IPsec	Select TCP and/or UDP.
Exception List	If you want to restrict some users/clients from transmitting data through the router by using the hardware acceleration function, check this box to create an exclusion list. MAC Address - Enter the MAC address of the client. ARP Table - Click to select the client listed on the ARP table.



Then, the MAC address of the selected client will be shown on the MAC Address field.  
 Exception Type - Select NAT and / or IPsec.  
 Description - Enter a brief explanation for the selected client.

### Checking the PPA status

For checking whether the rule of PPA is working or not, a user can login to Vigor2927 series by using telnet. User can view how many sessions are transferring in each direction of PPA table after entering “ppa -v”.

```

> ppa -v
% PPA mode is Auto
% PPA mode is Manual <traffic>
% PPA time is 10
% PPA range is 255
*****
WAN Acceleration session
Session - Src_ip:Src_port ----- Dest_ip:Dest_port --- Nat_ip:Nat_port
*****
⏳
*****
LAN Acceleration session
Session - Src_ip:Src_port ----- Dest_ip:Dest_port --- Nat_ip:Nat_port
*****
  0 - 192.168. 1. 10: 2938 - 119.236.154.122: 5590 - 192.168. 3. 10:52524
    Src_mac:00:22:15:8f:85:59 ---- Dest_mac:00:50:7f:37:c8:4c
  1 - 192.168. 1. 10: 2952 - 193. 88. 6. 13:33033 - 192.168. 3. 10:52538
    Src_mac:00:22:15:8f:85:59 ---- Dest_mac:00:50:7f:37:c8:4c
  
```

---

## II-4 NAT

Usually, the router serves as an NAT (Network Address Translation) router. NAT is a mechanism that one or more private IP addresses can be mapped into a single public one. Public IP address is usually assigned by your ISP, for which you may get charged. Private IP addresses are recognized only among internal hosts.

When the outgoing packets destined to some public server on the Internet reach the NAT router, the router will change its source address into the public IP address of the router, select the available public port, and then forward it. At the same time, the router shall list an entry in a table to memorize this address/port-mapping relationship. When the public server response, the incoming traffic, of course, is destined to the router's public IP address and the router will do the inversion based on its table. Therefore, the internal host can communicate with external host smoothly.

The benefit of the NAT includes:

- Save cost on applying public IP address and apply efficient usage of IP address. NAT allows the internal IP addresses of local hosts to be translated into one public IP address, thus you can have only one IP address on behalf of the entire internal hosts.
- Enhance security of the internal network by obscuring the IP address. There are many attacks aiming victims based on the IP address. Since the attacker cannot be aware of any private IP addresses, the NAT function can protect the internal network.



---

### Info

On NAT page, you will see the private IP address defined in RFC-1918. Usually we use the 192.168.1.0/24 subnet for the router. As stated before, the NAT facility can map one or more IP addresses and/or service ports into different specified services. In other words, the NAT function can be achieved by using port mapping methods.

---

---

## Web User Interface



---

### II-4-1 Port Redirection

Port Redirection is usually set up for server related service inside the local network (LAN), such as web servers, FTP servers, E-mail servers etc. Most of the case, you need a public IP address for each server and this public IP address/domain name are recognized by all users. Since the server is actually located inside the LAN, the network well protected by NAT of the router, and identified by its private IP address/port, the goal of Port Redirection function is to forward all access request with public IP address from external users to the mapping private IP address/port of the server.

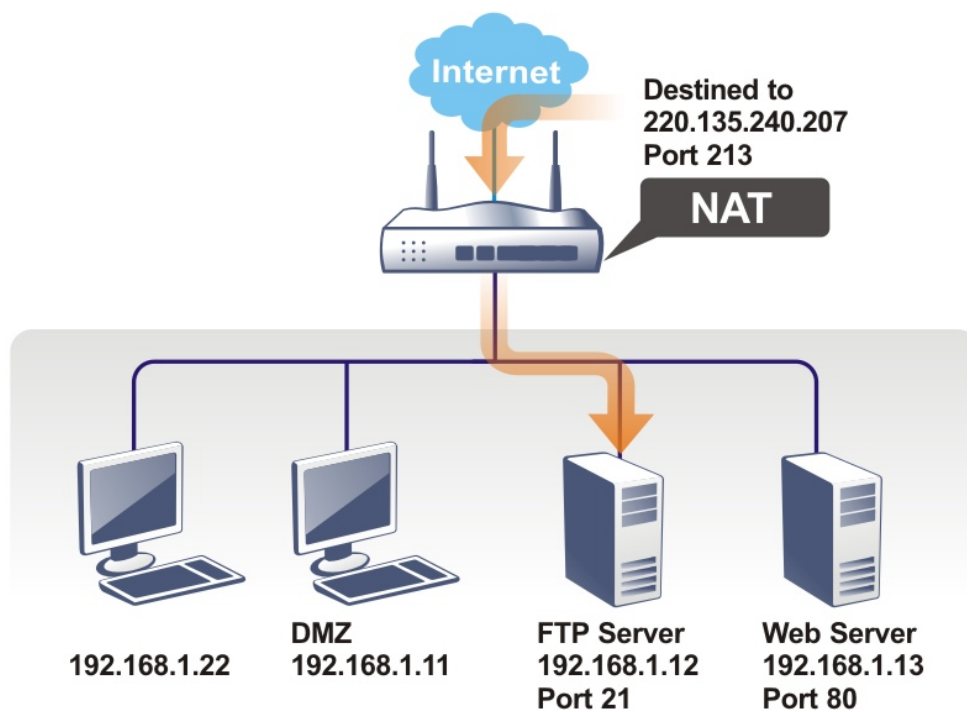

The port redirection can only apply to incoming traffic.

To use this function, please go to NAT page and choose Port Redirection web page. The Port Redirection Table provides 40 port-mapping entries for the internal hosts.

Port Redirection | [Set to Factory Default](#) |

Index	Enable	Service Name	WAN Interface	Protocol	Public Port	Source IP	Private IP
<u>1.</u>	<input type="checkbox"/>		All			Any	
<u>2.</u>	<input type="checkbox"/>		All			Any	
<u>3.</u>	<input type="checkbox"/>		All			Any	
<u>4.</u>	<input type="checkbox"/>		All			Any	
<u>5.</u>	<input type="checkbox"/>		All			Any	
<u>6.</u>	<input type="checkbox"/>		All			Any	
<u>7.</u>	<input type="checkbox"/>		All			Any	
<u>8.</u>	<input type="checkbox"/>		All			Any	
<u>9.</u>	<input type="checkbox"/>		All			Any	
<u>10.</u>	<input type="checkbox"/>		All			Any	
<u>11.</u>	<input type="checkbox"/>		All			Any	
<u>12.</u>	<input type="checkbox"/>		All			Any	
<u>13.</u>	<input type="checkbox"/>		All			Any	
<u>14.</u>	<input type="checkbox"/>		All			Any	
<u>15.</u>	<input type="checkbox"/>		All			Any	
<u>16.</u>	<input type="checkbox"/>		All			Any	
<u>17.</u>	<input type="checkbox"/>		All			Any	
<u>18.</u>	<input type="checkbox"/>		All			Any	
<u>19.</u>	<input type="checkbox"/>		All			Any	
<u>20.</u>	<input type="checkbox"/>		All			Any	
<u>21.</u>	<input type="checkbox"/>		All			Any	
<u>22.</u>	<input type="checkbox"/>		All			Any	
<u>23.</u>	<input type="checkbox"/>		All			Any	
<u>24.</u>	<input type="checkbox"/>		All			Any	
<u>25.</u>	<input type="checkbox"/>		All			Any	
<u>26.</u>	<input type="checkbox"/>		All			Any	
<u>27.</u>	<input type="checkbox"/>		All			Any	
<u>28.</u>	<input type="checkbox"/>		All			Any	
<u>29.</u>	<input type="checkbox"/>		All			Any	
<u>30.</u>	<input type="checkbox"/>		All			Any	
<u>31.</u>	<input type="checkbox"/>		All			Any	
<u>32.</u>	<input type="checkbox"/>		All			Any	
<u>33.</u>	<input type="checkbox"/>		All			Any	
<u>34.</u>	<input type="checkbox"/>		All			Any	
<u>35.</u>	<input type="checkbox"/>		All			Any	
<u>36.</u>	<input type="checkbox"/>		All			Any	
<u>37.</u>	<input type="checkbox"/>		All			Any	
<u>38.</u>	<input type="checkbox"/>		All			Any	
<u>39.</u>	<input type="checkbox"/>		All			Any	
<u>40.</u>	<input type="checkbox"/>		All			Any	

Backup settings: <input type="button" value="Backup"/>	Upload From File: <input type="button" value="選擇檔案"/> 未選擇任何檔案 <input type="button" value="Restore"/>
---	---

**Note:**  
 The port number values set in this page might be invalid due to the same values configured for Management Port Setup in [System Maintenance>>Management, Open VPN](#) and [SSL VPN](#).

Each item is explained as follows:

Item	Description
Index	Display the number of the profile.
Enable	Check the box to enable the port redirection profile.
Service Name	Display the description of the specific network service.
WAN Interface	Display the WAN IP address used by the profile.
Protocol	Display the transport layer protocol (TCP or UDP).
Public Port	Display the port number which will be redirected to the specified Private IP and Port of the internal host.
Source IP	Display the IP object of the source IP.
Private IP	Display the IP address of the internal host providing the service.
Backup	Click it to backup the configuration of port redirection settings.
Restore	Click it to restore the configuration of port redirection settings. Before clicking, make sure upload the configuration file onto Vigor router.

Press any number under Index to access into next page for configuring port redirection.

## NAT >> Port Redirection

### Index No. 1

<input type="checkbox"/> Enable	
Mode	Single ▾
Service Name	<input type="text"/>
Protocol	TCP ▾
WAN Interface	ALL ▾
Public Port	<input type="text" value="0"/>
Source IP	IP Object ▾ None ▾
Private IP	<input type="text"/>
Private Port	<input type="text" value="0"/>

#### Note:

In "Range" Mode the End IP will be calculated automatically once the Public Port and Start IP have been entered.

OK Clear Cancel

Available settings are explained as follows:

Item	Description
Enable	Check this box to enable such port redirection setting.
Mode	Two options (Single and Range) are provided here for you to choose. To set a range for the specific service, select Range. In Range mode, if the public port (start port and end port) and the starting IP of private IP had been entered, the system will calculate and display the ending IP of private IP automatically.
Service Name	Enter the description of the specific network service.
Protocol	Select the transport layer protocol (TCP or UDP).
WAN Interface	Select the WAN interface used for port redirection. There are eight WAN IP alias that can be selected and used for port redirection. The default setting is All which means all the incoming data from any port will be redirected to specified range of IP address and port.
Public Port	Specify which port can be redirected to the specified Private IP and Port of the internal host. If you choose Range as the port redirection mode, you will see two boxes on this field. Enter the required number on the first box (as the starting port) and the second box (as the ending port).
Source IP	IP Object - Use the drop down list to specify an IP object profile. IP Group - Use the drop down list to specify an IP group profile.
Private IP	Specify the private IP address of the internal host providing the service. If you choose Range as the port redirection mode, you will see two boxes on this field. Type a complete IP address in the first box (as the starting point). The second one will be assigned automatically later.
Private Port	Specify the private port number of the service offered by the internal host.

After finishing all the settings here, please click OK to save the configuration.

Note that the router has its own built-in services (servers) such as Telnet, HTTP and FTP etc. Since the common port numbers of these services (servers) are all the same, you may need to reset the router in order to avoid confliction.

For example, the built-in web user interface in the router is with default port 80, which may conflict with the web server in the local network, http://192.168.1.13:80. Therefore, you need to change the router's http port to any one other than the default port 80 to avoid conflict, such as 8080. This can be set in the System Maintenance >>Management Setup. You then will access the admin screen of by suffixing the IP address with 8080, e.g., http://192.168.1.1:8080 instead of port 80.

System Maintenance >> Management



IPv4 Management Setup	IPv6 Management Setup	LAN Access Setup												
Router Name <input type="text" value="DrayTek"/>														
<input type="checkbox"/> Default:Disable Auto-Logout <input type="checkbox"/> Enable Validation Code in Internet/LAN Access <b>Note:</b> IE8 and below version does NOT support DrayOS CAPTCHA auth code.	<b>Management Port Setup</b> <input checked="" type="radio"/> User Define Ports <input type="radio"/> Default Ports Telnet Port <input type="text" value="23"/> (Default: 23) HTTP Port <input type="text" value="80"/> (Default: 80) HTTPS Port <input type="text" value="443"/> (Default: 443) FTP Port <input type="text" value="21"/> (Default: 21) TR069 Port <input type="text" value="8069"/> (Default: 8069) SSH Port <input type="text" value="22"/> (Default: 22) <b>Note:</b> Ports 8001 and 8043 are used for Hotspot Web Portal.													
<b>Internet Access Control</b> <input type="checkbox"/> Allow management from the Internet Domain name allowed <input type="text"/> <input type="checkbox"/> FTP Server <input type="checkbox"/> HTTP Server <input checked="" type="checkbox"/> Enforce HTTPS Access <input checked="" type="checkbox"/> HTTPS Server <input type="checkbox"/> Telnet Server <input type="checkbox"/> TR069 Server <input type="checkbox"/> SSH Server <input type="checkbox"/> SNMP Server <input checked="" type="checkbox"/> Disable PING from the Internet	<b>Brute Force Protection</b> <input type="checkbox"/> Enable brute force login protection <input type="checkbox"/> FTP Server <input type="checkbox"/> HTTP Server <input type="checkbox"/> HTTPS Server <input type="checkbox"/> Telnet Server <input type="checkbox"/> TR069 Server <input type="checkbox"/> SSH Server <input type="checkbox"/> VPN Server Maximum login failures <input type="text" value="0"/> times Penalty period <input type="text" value="0"/> seconds													
<b>Access List from the Internet</b> <input type="checkbox"/> Apply Access List to PING List <table border="1"> <thead> <tr> <th></th> <th>IP Object</th> <th>IP / Mask</th> </tr> </thead> <tbody> <tr> <td>1</td> <td><input type="text" value="None"/></td> <td><input type="text"/></td> </tr> <tr> <td>2</td> <td><input type="text" value="None"/></td> <td><input type="text"/></td> </tr> <tr> <td>3</td> <td><input type="text" value="None"/></td> <td><input type="text"/></td> </tr> </tbody> </table>		IP Object	IP / Mask	1	<input type="text" value="None"/>	<input type="text"/>	2	<input type="text" value="None"/>	<input type="text"/>	3	<input type="text" value="None"/>	<input type="text"/>		
	IP Object	IP / Mask												
1	<input type="text" value="None"/>	<input type="text"/>												
2	<input type="text" value="None"/>	<input type="text"/>												
3	<input type="text" value="None"/>	<input type="text"/>												

## II-4-2 DMZ Host

As mentioned above, Port Redirection can redirect incoming TCP/UDP or other traffic on particular ports to the specific private IP address/port of host in the LAN. However, other IP protocols, for example Protocols 50 (ESP) and 51 (AH), do not travel on a fixed port. Vigor router provides a facility DMZ Host that maps ALL unsolicited data on any protocol to a single host in the LAN. Regular web surfing and other such Internet activities from other clients will continue to work without inappropriate interruption. DMZ Host allows a defined internal user to be totally exposed to the Internet, which usually helps some special applications such as Netmeeting or Internet Games etc.

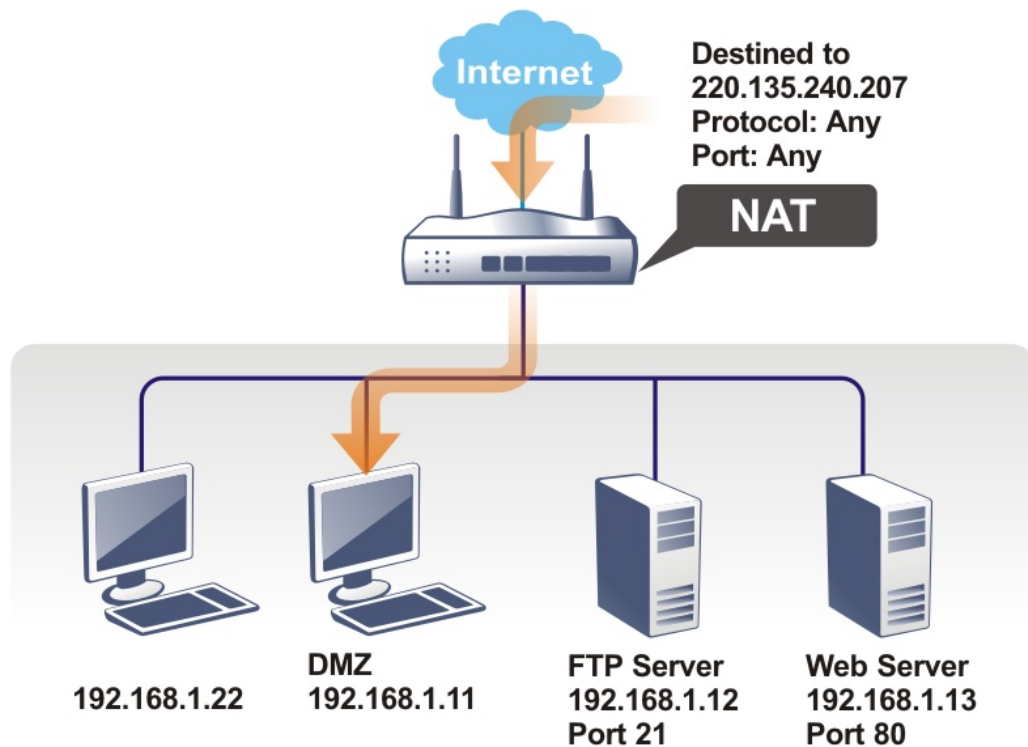

The security properties of NAT are somewhat bypassed if you set up DMZ host. We suggest you to add additional filter rules or a secondary firewall.

Click DMZ Host to open the following page. You can set different DMZ host for each WAN interface. Click the WAN tab to switch into the configuration page for that WAN.

NAT >> DMZ Host Setup

DMZ Host Setup

WAN1	WAN2	WAN3	WAN4	LTE	WAN6
WAN 1					
None					
Private IP					
<input type="text"/>					
<input type="button" value="Choose IP"/>					

Available settings are explained as follows:

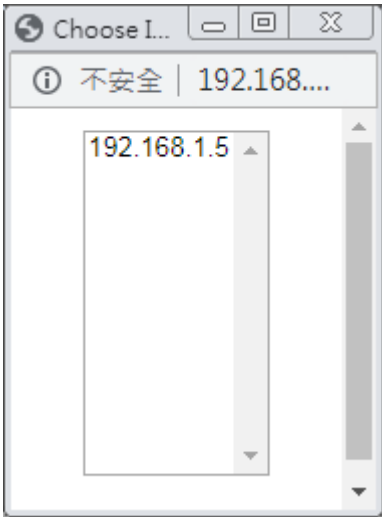
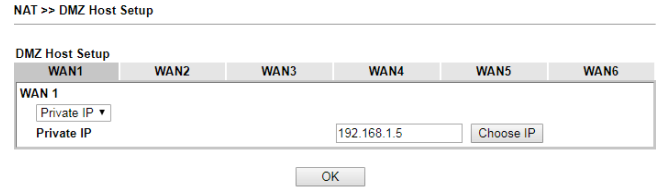
Item	Description
WAN 1	Choose Private IP or None first.
Private IP	Enter the private IP address of the DMZ host, or click Choose PC to select one.
Choose IP	<p>Click this button and then a window will automatically pop up, as depicted below. The window consists of a list of private IP addresses of all hosts in your LAN network. Select one private IP address in the list to be the DMZ host.</p>  <p>When you have selected one private IP from the above dialog, the IP address will be shown on the following screen. Click OK to save the setting.</p> 

DMZ Host for WAN2, WAN3, LTE or WAN4 is slightly different with WAN1. Active True IP selection is available for WAN1 only.

See the following figure.

NAT >> DMZ Host Setup



OK

If you previously have set up WAN Alias for PPPoE or Static or Dynamic IP mode in WAN2 interface, you will find them in Aux. WAN IP for your selection.



## NAT >> DMZ Host Setup

DMZ Host Setup				WAN1	WAN2	WAN3	WAN4	WAN5	WAN6
WAN 2									
Index	Enable	Aux. WAN IP	Private IP						
1.	<input type="checkbox"/>	10.39.0.10	0.0.0.0						Choose IP
2.	<input type="checkbox"/>	10.39.0.150	0.0.0.0						Choose IP

Available settings are explained as follows:

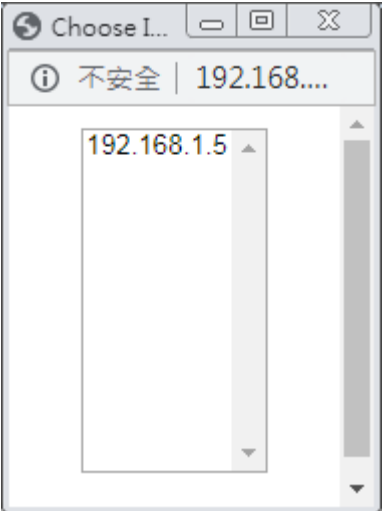
Item	Description
Enable	Check to enable the DMZ Host function.
Private IP	Enter the private IP address of the DMZ host, or click Choose PC to select one.
Choose IP	<p>Click this button and then a window will automatically pop up, as depicted below. The window consists of a list of private IP addresses of all hosts in your LAN network. Select one private IP address in the list to be the DMZ host.</p>  <p>When you have selected one private IP from the above dialog, the IP address will be shown on the screen. Click OK to save the setting.</p>

After finishing all the settings here, please click OK to save the configuration.

## II-4-3 Open Ports

Open Ports allows you to open a range of ports for the traffic of special applications.

Common application of Open Ports includes P2P application (e.g., BT, KaZaA, Gnutella, WinMX, eMule and others), Internet Camera etc. Ensure that you keep the application involved up-to-date to avoid falling victim to any security exploits.

Click Open Ports to open the following page:

NAT >> Open Ports

Open Ports Setup

[Set to Factory Default](#)

Index	Enable	Comment	WAN Interface	Source IP	Local IP Address
1.	<input type="checkbox"/>			Any	
2.	<input type="checkbox"/>			Any	
3.	<input type="checkbox"/>			Any	
4.	<input type="checkbox"/>			Any	
5.	<input type="checkbox"/>			Any	
6.	<input type="checkbox"/>			Any	
7.	<input type="checkbox"/>			Any	
8.	<input type="checkbox"/>			Any	
...					
38.	<input type="checkbox"/>			Any	
39.	<input type="checkbox"/>			Any	
40.	<input type="checkbox"/>			Any	

OK Cancel

Backup settings: <input type="button" value="Backup"/>	Upload From File: <input type="button" value="選擇檔案"/> 未選擇任何檔案 <input type="button" value="Restore"/>
---	---

Note:

The port number values set in this page might be invalid due to the same values configured for Management Port Setup in [System Maintenance>>Management, Open VPN](#) and [SSL VPN](#).

Available settings are explained as follows:

Item	Description
Index	Indicate the relative number for the particular entry that you want to offer service in a local host. You should click the appropriate index number to edit or clear the corresponding entry.
Enable	Check the box to enable the open port profile.
Comment	Specify the name for the defined network service.
WAN Interface	Display the WAN interface used by such index.
Aux. WAN IP	Display the IP alias setting used by such index. If no IP alias setting exists, such field will not appear.
Source IP	Display the name of the IP object.
Local IP Address	Display the private IP address of the local host offering the service.

Backup	Click it to backup the configuration of open ports settings.
Restore	Click it to restore the configuration of open ports settings. Before clicking, make sure upload the configuration file onto Vigor router.

To add or edit port settings, click one index number on the page. The index entry setup page will pop up. In each index entry, you can specify 10 port ranges for diverse services.

NAT >> Open Ports >> Edit Open Ports

Index No. 1

Enable Open Ports

Comment

WAN Interface

Source IP

Private IP

	Protocol	Start Port	End Port		Protocol	Start Port	End Port
1.	<input type="text" value="TCP/UDP"/>	<input type="text" value="0"/>	<input type="text" value="0"/>	2.	<input type="text" value="TCP/UDP"/>	<input type="text" value="0"/>	<input type="text" value="0"/>
3.	<input type="text" value="TCP/UDP"/>	<input type="text" value="0"/>	<input type="text" value="0"/>	4.	<input type="text" value="TCP/UDP"/>	<input type="text" value="0"/>	<input type="text" value="0"/>
5.	<input type="text" value="TCP/UDP"/>	<input type="text" value="0"/>	<input type="text" value="0"/>	6.	<input type="text" value="TCP/UDP"/>	<input type="text" value="0"/>	<input type="text" value="0"/>
7.	<input type="text" value="TCP/UDP"/>	<input type="text" value="0"/>	<input type="text" value="0"/>	8.	<input type="text" value="TCP/UDP"/>	<input type="text" value="0"/>	<input type="text" value="0"/>
9.	<input type="text" value="TCP/UDP"/>	<input type="text" value="0"/>	<input type="text" value="0"/>	10.	<input type="text" value="TCP/UDP"/>	<input type="text" value="0"/>	<input type="text" value="0"/>

Available settings are explained as follows:

Item	Description
Enable Open Ports	Check to enable this entry.
Comment	Make a name for the defined network application/service.
WAN Interface	Specify the WAN interface that will be used for this entry.
Source IP	Any - Any IP can be used as the source IP. IP Object - Use the drop down list to specify an IP object profile. IP Group - Use the drop down list to specify an IP group profile.
WAN IP	Specify the WAN IP address that will be used for this entry. This setting is available when WAN IP Alias is configured.
Private IP	Enter the private IP address of the local host or click Choose PC to select one. Choose IP - Click this button and, subsequently, a window having a list of private IP addresses of local hosts will automatically pop up. Select the appropriate IP address of the local host in the list.
Protocol	Specify the transport layer protocol. It could be TCP, UDP, or ----- (none) for selection.
Start Port	Specify the starting port number of the service offered by the local host.
End Port	Specify the ending port number of the service offered by the local host.

After finishing all the settings here, please click OK to save the configuration.

NAT >> Open Ports

Open Ports Setup							<a href="#">Set to Factory Default</a>
Index	Enable	Comment	WAN Interface	Aux. WAN IP	Source IP	Local IP Address	
<u>1.</u>	<input checked="" type="checkbox"/>	first	WAN3		Any	192.168.1.13	
<u>2.</u>	<input type="checkbox"/>				Any		
<u>3.</u>	<input type="checkbox"/>				Any		

## II-4-4 Port Triggering

Port Triggering is a variation of open ports function.

The key difference between "open port" and "port triggering" is:

- Once the OK button is clicked and the configuration has taken effect, "open port" keeps the ports opened forever.
- Once the OK button is clicked and the configuration has taken effect, "port triggering" will only attempt to open the ports once the triggering conditions are met.
- The duration that these ports are opened depends on the type of protocol used. The "default" durations are shown below and these duration values can be modified via telnet commands.

TCP: 86400 sec.

UDP: 180 sec.

IGMP: 10 sec.

TCP WWW: 60 sec.

TCP SYN: 60 sec.

NAT >> Port Triggering

Port Triggering								<a href="#">Set to Factory Default</a>
Index	Enable	Comment	Triggering Protocol	Source IP	Triggering Port	Incoming Protocol	Incoming Port	
<u>1.</u>	<input type="checkbox"/>			Any				
<u>2.</u>	<input type="checkbox"/>			Any				
<u>3.</u>	<input type="checkbox"/>			Any				
<u>4.</u>	<input type="checkbox"/>			Any				
<u>5.</u>	<input type="checkbox"/>			Any				
<u>6.</u>	<input type="checkbox"/>			Any				
<u>7.</u>	<input type="checkbox"/>			Any				
<u>8.</u>	<input type="checkbox"/>			Any				
<u>9.</u>	<input type="checkbox"/>			Any				
<u>10.</u>	<input type="checkbox"/>			Any				

<< [1-10](#) | [11-20](#) >>

[Next](#) >>

OK

Cancel

Available settings are explained as follows:

Item	Description
Index	Indicate the relative number for the port triggering profile. You should click the appropriate index number to edit or

	clear the corresponding entry.
Enable	Check the box to enable the Port Triggering profile.
Comment	Display the text which memorizes the application of this rule.
Triggering Protocol	Display the protocol of the triggering packets.
Source IP	Display the name of the IP object.
Triggering Port	Display the port of the triggering packets.
Incoming Protocol	Display the protocol for the incoming data of such triggering profile.
Incoming Port	Display the port for the incoming data of such triggering profile.

Click the index number link to open the configuration page.

NAT >> Port Triggering

No. 1

Enable

Service User Defined ▾

Comment

Source IP Any ▾

Triggering Protocol Any ▾

Triggering Port IP Object  
IP Group

Incoming Protocol --- ▾

Incoming Port

**Note:**  
The Triggering Port and Incoming Port should be input like this :  
123-456,777-789 (legal),123-456,789 (legal), but 123-456-789 (illegal).

Available settings are explained as follows:

Item	Description
Enable	Check to enable this entry.
Service	Choose the service type to apply for such trigger profile.
Comment	Enter the text to memorize the application of this rule.
Source IP	Any - Any IP can be used as the source IP. IP Object - Use the drop down list to specify an IP object profile. IP Group - Use the drop down list to specify an IP group profile.
Triggering Protocol	Select the protocol (TCP, UDP or TCP/UDP) for such triggering profile.
Triggering Port	Enter the port or port range for such triggering profile.
Incoming Protocol	When the triggering packets received, it is expected the incoming packets will use the selected protocol. Select the protocol (TCP, UDP or TCP/UDP) for the incoming data of such triggering profile.
Incoming Port	Enter the port or port range for the incoming packets.

After finishing all the settings here, please click OK to save the configuration.

## II-4-5 ALG

ALG means Application Layer Gateway. There are two methods provided by Vigor router, RTSP (Real Time Streaming Protocol) ALG and SIP (Session Initiation Protocol) ALG, for processing the packets of voice and video.

RTSP ALG makes RTSP message, RTCP message, and RTP packets of voice and video be transmitted and received correctly via NAT by Vigor router.

However, SIP ALG makes SIP message and RTP packets of voice be transmitted and received correctly via NAT by Vigor router.

NAT >> ALG

ALG (Application Layer Gateway) [Set to Factory Default](#)

Enable ALG

<input type="checkbox"/> Enable	Protocol	Listen Port	TCP	UDP
<input type="checkbox"/>	SIP	5060 (1~65535)	<input checked="" type="checkbox"/>	<input checked="" type="checkbox"/>
<input type="checkbox"/>	RTSP	554 (1~65535)	<input checked="" type="checkbox"/>	<input checked="" type="checkbox"/>

OK

Available settings are explained as follows:

Item	Description
Enable ALG	Check to enable such function.
Listen Port	Type a port number for SIP or RTSP protocol.
TCP	Check the box to make correspond protocol message packet from TCP transmit and receive via NAT.
UDP	Check the box to make correspond protocol message packet from UDP transmit and receive via NAT.

---

## II-5 Applications

### Dynamic DNS

Most ISPs assigns dynamic WAN IP addresses to their customers. Dynamic IP addresses presents challenges to users who would like to accept remote connections to their LANs from the Internet, as service could be disrupted due to the IP address changing without notice. By setting up service with a Dynamic DNS (DDNS) provider, and configuring Dynamic DNS updates on the Vigor router, you can have reliable access to your network by means of an easy-to-remember domain address that resolves to the most current WAN IP address.

The Vigor router supports a wide range of DDNS providers, such as DynDNS, No-IP.com, DtDNS, and ChangeIP. Please contact the DDNS provider of your choice to set up service before configuring DDNS on the router.

### LAN DNS / DNS Forwarding

LAN DNS allows the network administrator to override standard DNS resolutions for selecting domain addresses. The router will respond to queries on matched domain addresses with custom IP addresses.

DNS Forwarding allows the network administrator to forward DNS queries to different DNS servers based on the domain name.

LAN DNS and DNS Forwarding only affect DNS queries that are sent to the WAN through the router. DNS queries that are directed to a DNS server on the LAN will not be intercepted by the router.

### Schedule

The Vigor router has a built-in clock which can update itself manually or automatically by means of Network Time Protocols (NTP). As a result, you can not only schedule the router to dialup to the Internet at a specified time, but also restrict Internet access to certain hours so that users can connect to the Internet only during certain hours, say, business hours. The schedule is also applicable to other functions.

### RADIUS/TACACS+

Remote Authentication Dial-In User Service (RADIUS) is a security authentication client/server protocol that supports authentication, authorization and accounting, which is widely used by Internet service providers. It is the most common method of authenticating and authorizing dial-up and tunneled network users.

The built-in RADIUS client feature enables the router to assist the remote dial-in user or a wireless station and the RADIUS server in performing mutual authentication. It enables centralized remote access authentication for network management.

### LDAP /Active Directory Setup

Lightweight Directory Access Protocol (LDAP) is a communication protocol for using in TCP/IP network. It defines the methods to access distributing directory server by clients, work on directory and share the information in the directory by clients. The LDAP standard is established by the work team of Internet Engineering Task Force (IETF).

As the name described, LDAP is designed as an effect way to access directory service without the complexity of other directory service protocols. For LDAP is defined to perform, inquire and modify the information within the directory, and acquire the data in the directory

securely, therefore users can apply LDAP to search or list the directory object, inquire or manage the active directory.

## UPnP

The Vigor supports UPnP (Universal Plug and Play), which is a suite of network protocols that simplifies network configuration. Applications and network devices on the LAN, that support UPnP, may request the router to modify its settings to allow NAT Traversal, so that WAN hosts can connect to them directly.

Examples of applications and devices that support UPnP include file-sharing applications such as uTorrent, Vuze and eMule, gaming consoles such as the Sony PlayStations 3 and 4 Xbox 360 and Xbox One, media streaming applications such as Plex and XBMC, and messaging and calling applications such as Skype. To find out if a certain application or network device supports or requires UPnP, please consult its user manual or check with its vendor.

## Wake on LAN

Using the Wake on LAN (WoL) feature, LAN clients that support WoL can be powered on or resume from sleep over the network, without the need for physical access to the device.

In order for LAN clients to be able to woken from sleep or off states, the network interface card must be configured to monitor Wake-on-LAN messages. Consult the documentation of the LAN client for details on setting up its network interface for Wake on LAN.



# Web User Interface

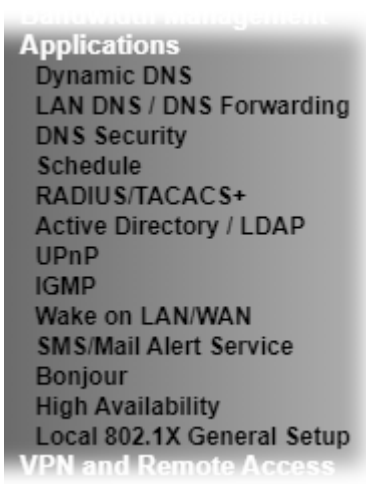

## II-5-1 Dynamic DNS

### Enable the Function and Add a Dynamic DNS Account

To begin configuring Dynamic DNS, from the main menu, navigate to Applications, and select Dynamic DNS. The Dynamic DNS main configuration screen appears:

Applications >> Dynamic DNS Setup

[Set to Factory Default](#)

Enable Dynamic DNS Setup [View Log](#) [Force Update](#)

Auto-Update interval  Min(s) (180~14400)

**Accounts:**

Index	Enable	WAN Interface	Domain Name
1.	<input type="checkbox"/>	WAN1 First	
2.	<input type="checkbox"/>	WAN1 First	
3.	<input type="checkbox"/>	WAN1 First	
4.	<input type="checkbox"/>	WAN1 First	
5.	<input type="checkbox"/>	WAN1 First	
6.	<input type="checkbox"/>	WAN1 First	

Available settings are explained as follows:

Item	Description
Enable Dynamic DNS Setup	Select to enable DDNS function.
Set to Factory Default	Click to clear all profiles to factory settings.
View Log	Select to display the most recent DDNS update messages.
Force Update	Click to connect immediately to DDNS servers to update IP address information.

Auto-Update interval	The frequency, in minutes, at which the router connects to DDNS servers to update IP address information.
Index	Click to bring up the configuration page of the DDNS profile.
Enable	Check the box to enable such account.
WAN Interface	Shows the WAN interface associated with the DDNS profile.
Domain Name	Shows the domain name with which the profile is associated.

After clicking on the index number, the detail configuration screen for the DDNS profile appears:

Applications >> Dynamic DNS Setup >> Dynamic DNS Account Setup

Index : 1

Enable Dynamic DNS Account

WAN Interface:

Service Provider:

Service Type:

Domain Name:  ,  ,

Login Name:

Password:

Wildcards

Backup MX

Mail Extender:

Determine WAN IP:

Let's Encrypt certificate

Status:

Auto Renew:

Note:

1. The Create function of Let's Encrypt certificate works only when the current profile has been stored.
2. WAN IP must be public IP when create Let's Encrypt certificate.

If User-Defined is specified as the service provider, the web page will be changed slightly as follows:

Applications >> Dynamic DNS Setup >> Dynamic DNS Account Setup

Index : 1

Enable Dynamic DNS Account  
 WAN Interface:   
 Service Provider:   
 Provider Host:   
 Service API:   
 Auth Type:   
 Connection Type:   
 Server Response:   
 Login Name:  (max. 64 characters)  
 Password:  (max. 23 characters)  
 Wildcards  
 Backup MX  
 Mail Extender:   
 Determine Real WAN IP:

Available settings are explained as follows:

Item	Description
Enable Dynamic DNS Account	Select to enable this DDNS profile.
WAN Interface	<p>Select the WAN interface to monitor for IP address changes.</p> <p><b>WANx First</b> - The specified WAN interface will be examined first. If it is online, its IP address will be used in the DDNS update.</p> <p><b>WANx Only</b> - Only the specified WAN interface will be examined. If the WAN interface is online, its IP address will be used in the DDNS update. Otherwise no update will be performed for this DDNS profile.</p>
Service Provider	<p>Select the DDNS provider. If your DDNS provider is not listed, select User-Defined and manually configure the profile.</p> <div style="border: 1px solid gray; padding: 5px; width: fit-content;"> <p>User-Defined</p> <p>User-Defined</p> <p>3322 DDNS (www.3322.org)</p> <p>ChangeIP.com (www.changeip.com)</p> <p>ddns.com.cn (www.ddns.com.cn)</p> <p>DrayDDNS (Global)</p> <p>DIDNS (www.dtdns.com)</p> <p>dyn.com (www.dyn.com)</p> <p>DynAccess (www.dynaccess.com)</p> <p>dynami.co.za (www.dynami.co.za)</p> <p>EntryDNS (entrydns.net)</p> <p>freedns.afraid.org (freedns.afraid.org)</p> <p>NO-IP.COM Free (www.no-ip.com)</p> </div> <ul style="list-style-type: none"> <li>● <b>Provider Host</b> - Enter the IP address or the domain name of the host which provides related service. Note that such option is available when Customized is selected as Service Provider.</li> <li>● <b>Service API</b> - Enter the API information obtained from DDNS server. Note that such option is available when Customized is</li> </ul>

	<p>selected as Service Provider.</p> <p>(e.g: /dynamic/dns/update.asp?u=jo***&amp;p=jo*****&amp;hostname=j****.changeip.org&amp;ip=###IP###&amp;cmd=update&amp;offline=0)</p> <ul style="list-style-type: none"> <li>● <b>Auth Type</b> - Two types can be used for authentication. Basic - Username and password defined later can be shown from the packets captured. URL - Username and password defined later can be shown in URL. (e.g., http://ns1.vigorddns.com/ddns.php?username=xxx&amp;password=xxx&amp;domain=xxx.vigorddns.com) Note that such option is available when Customized is selected as Service Provider.</li> <li>● <b>Connection Type</b> - There are two connection types (HTTP and HTTPS) to be specified. Note that such option is available when Customized is selected as Service Provider.</li> <li>● <b>Server Response</b> - Type any text that you want to receive from the DDNS server. Note that such option is available when Customized is selected as Service Provider.</li> </ul> <p>If other service provider is selected, you have to configure Service Type, Domain Name, Login Name and Password.</p> <ul style="list-style-type: none"> <li>● <b>Service Type</b> - Select the service type that matches that of your DynDNS account. If you are unsure which service type to select, try Dynamic first. This options is applicable to DynDNS only.</li> <li>● <b>Domain Name</b> - The domain and subdomain to be updated.</li> </ul>
Login Name	The login name of the DDNS account.
Password	The password of the DDNS account.
Wildcard and Backup MX	The Wildcard and Backup MX (Mail Exchange) features are not supported for all Dynamic DNS providers. You could get more detailed information from their websites.
Mail Extender	If the mail server is defined with another name, please enter the name in this area. Such mail server will be used as backup mail exchange.
Determine WAN IP	<p>If a Vigor router is installed behind any NAT router, you can enable such function to locate the real WAN IP.</p> <p>When the WAN IP used by Vigor router is private IP, this function can detect the public IP used by the NAT router and use the detected IP address for DDNS update.</p> <p>There are two methods offered for you to choose:</p> <ul style="list-style-type: none"> <li>● <b>WAN IP</b> - The IP address of the router's WAN interface will be used.</li> <li>● <b>Internet IP</b> - The real public IP address will be used. Select this option if the IP address assigned to the router's WAN interface is not the actual external IP address.</li> </ul>

Click OK to save changes, Clear to clear all settings, or Cancel to discard changes and return to the main DDNS screen.

## DrayDDNS Settings

DrayDDNS, a new DDNS service developed by DrayTek, can record multiple WAN IP (IPv4) on single domain name. It is convenient for users to use and easily to set up. Each Vigor Router is available to register one domain name.

Choose DrayDDNS (Global) as the service provider, the web page will be displayed as follows:

Applications >> Dynamic DNS Setup >> Dynamic DNS Account Setup

Index : 1

<input checked="" type="checkbox"/>	Enable Dynamic DNS Account		
	Service Provider	DrayDDNS (Global)	Wizard View Log
	Status	Inactivated	
	Domain Name	Max: 54 characters .drayddns.com	Sync domain
	Determine WAN IP	WAN IP <input checked="" type="checkbox"/> IPv4 <input type="checkbox"/> IPv6	
	WAN Interfaces	<input type="checkbox"/> WAN 1 <input type="checkbox"/> WAN 2 <input type="checkbox"/> WAN 3 <input type="checkbox"/> WAN 4 <input type="checkbox"/> LTE <input type="checkbox"/> WAN 6 <input type="checkbox"/> Alias IP in <a href="#">Service Status Setup</a>	
	Connection Type	Http	
	Let's Encrypt certificate		
	Status	Empty	Create
	Auto Renew	<input type="checkbox"/>	

Note:

1. The Create function of Let's Encrypt certificate works only when the current profile has been stored.

OK Clear Cancel

Available settings are explained as follows:

Item	Description
Enable Dynamic DNS Account	Check this box to enable the current account. If you did check the box, you will see a check mark appeared on the Active column of the previous web page in step 2).
Service Provider	Choose DrayDDNS (Global) as the service provider. Wizard - This button is available when DrayTek Global is selected as Service Provider. To activate the DrayTek's DDNS service, click it to enable license issued by DrayTek through Wizards>>Service Activation Wizard. Refer to section A-1 How to use DrayDDNS? for detailed information.
Status	Display if the license is actvtaed or not.
Determine WAN IP	If a Vigor router is installed behind any NAT router, you can enable such function to locate the real WAN IP. When the WAN IP used by Vigor router is private IP, this function can detect the public IP used by the NAT router and use the detected IP address for DDNS update. There are two methods offered for you to choose: <ul style="list-style-type: none"> <li>● WAN IP - If it is selected and the WAN IP of Vigor router is private, DDNS update will take place right away.</li> <li>● Internet IP - If it is selected and the WAN IP of Vigor router is private, it will be converted to public IP before DDNS update takes place.</li> </ul>

WAN Interfaces	WANx - While connecting, the router will use WANx as the channel for such account.
Let's Encrypt certificate	<p>Create - Click it to generate a certificate issued by Let's Encrypt for applying to such DDNS account.</p> <p>Auto Update - Check the box to make the system update the certificate automatically.</p>

### Disable the Function and Clear all Dynamic DNS Accounts

Uncheck Enable Dynamic DNS Setup, and click Clear All button to disable the function and clear all accounts from the router.

### Delete a Dynamic DNS Account

Click the Index number you want to delete and then click Clear All button to delete the account.

DDNS updates take place when:

- The router is powered on or rebooted.
- The public IP address of any WAN interface changes.
- The online status of a WAN interface changes (going from online to offline or vice versa).
- The DDNS function is changed from disabled to enabled.
- A DDNS entry is modified and enabled.
- The Auto-Update Interval has elapsed.

### Procedures for Setting up a Dynamic DNS Entry

1. Contact the dynamic DNS provider of your choice and have service set up. Most DDNS providers accept signups on their websites. Service could be provided free of charge or for a fee.
2. Create a DDNS entry on the router by selecting the appropriate DDNS provider and enter the account information.
3. Make sure that both the DDNS entry and the DDNS feature are enabled on the router.
4. Click the View Log button on the DDNS main page to bring up the update log.
5. Examine the update log to make sure the update was successful.
6. If the update was not successful, verify the DDNS entry to make sure the settings are entered correctly.

## II-5-2 LAN DNS / DNS Forwarding

LAN DNS lets the network administrators host servers with privacy and security. When the network administrators of your office set up FTP, Mail or Web server inside LAN, you can specify specific private IP address (es) to correspondent servers. Thus, even the remote PC is adopting public DNS as the DNS server, the LAN DNS resolution on Vigor2927 series will respond the specified private IP address.

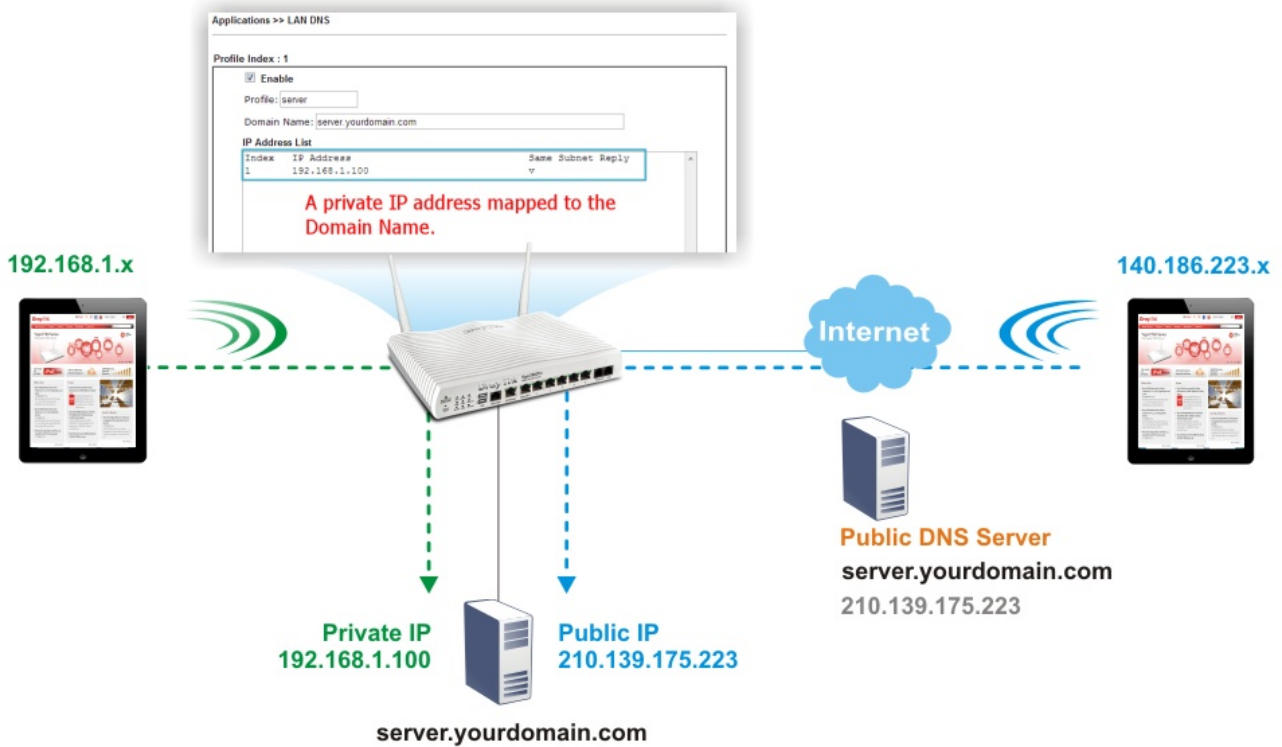

To start configuring LAN DNS or DNS Forwarding, from the main menu, click Applications, followed by LAN DNS / DNS Forwarding.

Applications >> LAN DNS / DNS Forwarding

?

LAN DNS Resolution / Conditional DNS Forwarding | [Set to Factory Default](#)

Index	Enable	Profile	Domain Name	Type	DNS Server
1.	<input type="checkbox"/>			-	
2.	<input type="checkbox"/>			-	
3.	<input type="checkbox"/>			-	
4.	<input type="checkbox"/>			-	
5.	<input type="checkbox"/>			-	
6.	<input type="checkbox"/>			-	
7.	<input type="checkbox"/>			-	
8.	<input type="checkbox"/>			-	
9.	<input type="checkbox"/>			-	
10.	<input type="checkbox"/>			-	

<< 1-10 | 11-20 | 21-30 | 31-40 | 41-50 | 51-60 | 61-70 | 71-80 | 81-90 | 91-100 | 101-110 | 111-120 >>

OK

Each item is explained as follows:

Item	Description
Set to Factory Default	Click to clear all profiles to factory settings.
Index	Click to bring up the configuration page for the profile.

Enable	Select to enable this profile.
Profile	Shows the name of the profile.
Domain Name	Shows the domain name configured for the profile.
Type	Display the type (LAN DNS or DNS Forwarding) of the profile.
DNS Server	DNS server to which DNS queries for the specified domain name will be forwarded.

To configure a LAN DNS profile, click on its index to bring up the configuration page.

Applications >> LAN DNS / DNS Forwarding

Profile Index : 1

**Enable**

Profile:

Type:  ▼

Domain Name:

**Note:**

1. Support wildcard subdomain, ex: \*.example.com
2. One domain Name has only one IPv4 address and IPv6 address in the same subnet.

CNAME(Alias Domain Name):

**IP Address List (Max. 40 entries)**

Index	IP Address	Same Subnet Reply

Available settings are explained as follows:

Item	Description
Enable	Select to enable this profile.
Profile	Enter a name to identify this profile. <b>Note:</b> If you type a name here for LAN DNS and click OK to save the configuration, the name also will be applied to conditional DNS forwarding automatically.
Type	Choose LAN DNS or LAN Forwarding.
If LAN DNS is selected	<p><b>Domain Name</b> - Enter the domain name for the router to look for in DNS queries to intercept and reply to. Wildcards in the form of asterisks (*) can be used to match a domain level. For example, *.draytek.com will match domain names such as www.draytek.com and ftp.draytek.com, whereas www.draytek.* will match domain names such as www.draytek.com and www.draytek.co.uk.</p> <p><b>CNAME</b> - Click Add to add an domain name alias for the domain name. Click Delete next to an alias entry to delete it.</p>

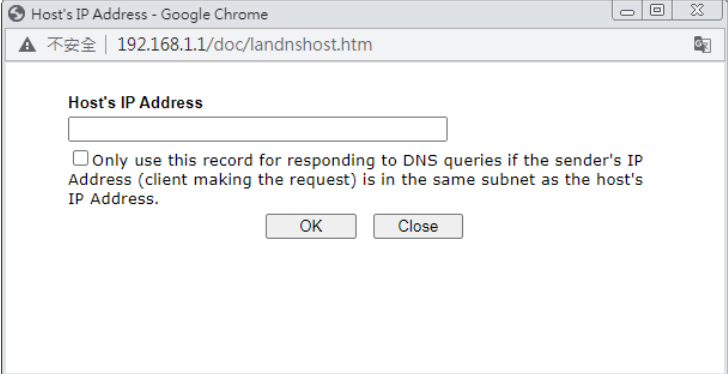

	<p>IP Address List - The IP address listed here will be used for mapping with the domain name specified above. In general, one domain name maps with one IP address. If required, you can configure two IP addresses mapping with the same domain name.</p> <p>Add -Click Add to bring up the Add IP Address dialog box:</p>  <ul style="list-style-type: none"> <li>● Host's IP Address - Enter the IP address to be returned in response to a DNS query for the configured domain names and aliases.</li> <li>● Only responds to the DNS.... - Select to use this IP address only if the IP address of the source of the DNS query belongs to the same subnet as the host IP address entered above.</li> </ul> <p>After changes have been made, click OK to save and dismiss the dialog box, or Close to discard the changes and dismiss the dialog box.</p> <p>Delete -To delete an IP address, click on it and then click Delete.</p>
<p>If DNS Forwarding is selected</p>	<p>Domain Name - Enter the domain name for the router to look for in DNS queries to intercept and reply to. Wildcards in the form of asterisks (*) can be used to match a domain level. For example, *.draytek.com will match domain names such as www.draytek.com and ftp.draytek.com, whereas www.draytek.* will match domain names such as www.draytek.com and www.draytek.co.uk.</p> <p>DNS Server IP Address - Enter the IP address of the DNS server you want to use for DNS forwarding.</p>

To save changes made to the LAN DNS profile, click OK. To clear the profile and restore the factory default blank values, click Clear.

## II-5-3 DNS Security

Domain Name System Security Extensions (DNSSEC) protects against DNS-based attacks by authenticating DNS responses from DNS resolvers.

The DNS servers must support DNS security validation for the feature to function properly.

To configure DNS security, from the main menu, click **Applications**, followed by **DNS Security**.

### II-5-3-1 General Setup

All of WAN interfaces of Vigor router can be configured with DNS Security enabled respectively.

Application >> DNS Security



#### DNS Security

General Setup		Domain Diagnosis		Refresh
Interface	Enable	Primary DNS	Secondary DNS	Bogus DNS Reply
WAN1	<input type="checkbox"/>	---	---	Pass ▼
WAN2	<input type="checkbox"/>	---	---	Pass ▼
WAN3	<input type="checkbox"/>	---	---	Pass ▼
WAN4	<input type="checkbox"/>	---	---	Pass ▼
LTE	<input type="checkbox"/>	---	---	Pass ▼
WAN6	<input type="checkbox"/>	---	---	Pass ▼

**Note:**



The DNS server supports DNSSEC



The DNS server does not support DNSSEC, function may not work as expected even if it is enabled

OK

Available settings are explained as follows:

Item	Description
Interface	The WAN interface name for which DNS security is to be configured.
Enable	Select to enable DNS security for this WAN Interface.
Primary DNS	Shows the primary DNS server IP address in effect for this WAN.
Secondary DNS	Shows the secondary DNS server IP address in effect for this WAN.
Bogus DNS Reply	Show action to be taken for DNS responses that fail authentication. Choose Pass or Drop. Pass - Pass DNS result. Drop - Do not pass DNS result.

Press OK to save changes.

## II-5-3-2 Domain Diagnose

While using the Domain Diagnose feature, you can check to see if the router's DNS security function is working properly, or whether a given domain is secured by DNS security. Note that DNS Security has to be first enabled or the test results would not be meaningful.

Application >> DNS Security



### DNS Security

General Setup	Domain Diagnosis	DNS Cache												
Domain: <input type="text"/> <input checked="" type="radio"/> IPv4 <input type="radio"/> IPv6 Interface: <input type="text" value="WAN1"/> <input type="button" value="Diagnose"/> DNS Server: <input type="text"/> <b>Note:</b> If the domain has not been queried before, it will take a few seconds to process.														
<b>Result</b> <span style="float: right;">  <a href="#">Clear</a>  </span> <table border="1"> <thead> <tr> <th>Domain Name</th> <th>IP Address</th> <th>Interface</th> <th>Verify Result</th> </tr> </thead> <tbody> <tr> <td colspan="4" style="text-align: center;">-----</td> </tr> <tr> <td> </td> <td> </td> <td> </td> <td> </td> </tr> </tbody> </table>			Domain Name	IP Address	Interface	Verify Result	-----							
Domain Name	IP Address	Interface	Verify Result											
-----														

Available settings are explained as follows:

Item	Description
Domain	Enter domain address to be diagnosed. Select the type of IP address to be looked up. IPv4 - looks up A records. IPv6 - looks up AAAA records.
Interface	Select the WAN port to be used for the lookup.
DNS Server	Enter the IPv4 address of the DNS server to be used for the lookup.
Diagnose	Click to begin DNS lookup.
Result	The history of domain diagnosis is shown in the Result panel.

## II-5-4 Schedule

Time schedules can be created and used with router features that support them, so that those features can be turned on and off automatically at preconfigured times.

Applications >> Schedule

Schedule : Current System Time  | [System time set](#) | [Set to Factory Default](#) |

Index	Enable	Comment	Time	Frequency
1	<input type="checkbox"/>			Sun.
2	<input type="checkbox"/>			Sun.
3	<input type="checkbox"/>			Sun.
4	<input type="checkbox"/>			Sun.
5	<input type="checkbox"/>			Sun.
6	<input type="checkbox"/>			Sun.
7	<input type="checkbox"/>			Sun.
8	<input type="checkbox"/>			Sun.
9	<input type="checkbox"/>			Sun.
10	<input type="checkbox"/>			Sun.
11	<input type="checkbox"/>			Sun.
12	<input type="checkbox"/>			Sun.
13	<input type="checkbox"/>			Sun.
14	<input type="checkbox"/>			Sun.
15	<input type="checkbox"/>			Sun.

Force on     Force down

Available settings are explained as follows:

Item	Description
Current System Time	Shows the current time of the router.
System time set	Click to navigate to System Maintenance >> Time and Date to set the system time and date.
Set to Factory Default	Reset all schedules to factory default values.
Index	Shows the index number of the schedule entry.
Enable	Select to enable the schedule; clear to disable it.
Comment	Shows the name given to the schedule.
Time	Shows the start and end times of the schedule. The time interval of the schedule is indicated in dark grey.

Frequency	Shows the days of the week configured for the schedule. Selected days are shown in dark grey. ● - If it lights in green, it means such schedule is active.
-----------	---

To configure a schedule, click on its index to bring up the settings page.

Applications >> Schedule

Index No. 1 Current System Time 2000 Jan 1 Sat 5 : 12 : 8 | System time set |

Enable Schedule Setup

Comment

Start Date (yyyy-mm-dd) 2000 ▾ 1 ▾ 1 ▾

Start Time (hh:mm) 0 ▾ : 0 ▾

Duration Time (hh:mm) 0 ▾ : 0 ▾

End Time (hh:mm) 00 : 00

Action Force On ▾

---

How Often

Once

Weekdays

Sun  Mon  Tue  Wed  Thu  Fri  Sat

Monthly, on date 1 ▾

Cycle duration: 1 ▾ days (Cycle will start on the Start Date.)

**Note:**

Comment can not contain characters ~ ! @ # \$ % ^ & \* ( ) ' " { } | ;

OK Clear Cancel

Available settings are explained as follows:

Item	Description
Enable Schedule Setup	Select to enable the schedule; clear to disable it.
Comment	Name to identify this schedule entry.
Start Date (yyyy-mm-dd)	The date when the entry comes into effect.
Start Time (hh:mm)	The time when the schedule is triggered. See the How Often setting below for details.
Duration Time (hh:mm)	How long the action lasts when the scheduled is triggered.
End Time (hh:mm)	It will be calculated automatically when Start Time and Duration Time are configured well.
Action	Action to take when the schedule is triggered. Force On - The feature with which this schedule is associated will be turned on. Force Down - The feature with which this schedule is associated will be turned off.
How Often	How frequently the schedule is triggered. <ul style="list-style-type: none"> <li>● Once - The schedule is triggered once, on the Start Date at the Start Time, for the Duration Time.</li> <li>● Weekdays - The schedule will be triggered repeatedly, starting on the Start Date at the Start Time, on the selected days of the week, at the Start Time, for the Duration Time.</li> </ul>

- Monthly, on date - The router will only execute the action applied such schedule on the date (1 to 28) of a month.
- Cycle duration - Type a number as cycle duration. Then, any action applied such schedule will be executed per several days. For example, "3" is selected as cycle duration. That means, the action applied such schedule will be executed every three days since the date defined on the Start Date.

To save changes made to the Schedule, click OK. To clear the schedule and restore the factory default blank values, click Clear. To cancel the changes and return to the main Schedule page, click Cancel.

#### Example

Suppose you want to control the PPPoE Internet access connection to be always on (Force On) from 9:00 to 18:00 for whole week. Other time the Internet access connection should be disconnected (Force Down).

Office  
Hour:  
(Force On)



Mon - Sun      9:00 am      to      6:00 pm

1. Make sure the PPPoE connection and Time Setup is working properly.
2. Configure the PPPoE always on from 9:00 to 18:00 for whole week.
3. Configure the Force Down from 18:00 to next day 9:00 for whole week.
4. Assign these two profiles to the PPPoE Internet access profile. Now, the PPPoE Internet connection will follow the schedule order to perform Force On or Force Down action according to the time plan that has been pre-defined in the schedule profiles.

---

## II-5-5 RADIUS/TACACS+

Remote Authentication Dial-In User Service (RADIUS) is a security authentication client/server protocol that supports authentication, authorization and accounting, which is widely used by Internet service providers. It is the most common method of authenticating and authorizing dial-up and tunneled network users.

The router supports external TACACS+ and internal and external RADIUS servers for user authentication. Services that require user authentication include WLAN and VPN.

To configure RADIUS or TACACS+ servers, from the Main Menu select Applications >> RADIUS/TACACS+.

### II-5-5-1 External RADIUS

The built-in RADIUS client feature enables the router to assist the remote dial-in user or a wireless station and the RADIUS server in performing mutual authentication. It enables centralized remote access authentication for network management.

Vigor router can be operated as a RADIUS client. This web page is used to configure settings for external RADIUS server. Then LAN users of Vigor router will be authenticated and accounted by such server for network application.

Select External RADIUS to configure the router to use an external RADIUS server for user authentication.

External RADIUS	Internal RADIUS	External TACACS+
<input checked="" type="checkbox"/> Enable <input checked="" type="checkbox"/> Enable Accounting Comments: <input type="text" value="Max: 23 characters"/> RADIUS Request Interval <input type="text" value="2"/> sec (2~30)		
<b>Primary Server</b>		
-----		
Primary Server	<input type="text" value="Max: 63 characters"/>	
Secret	<input type="text" value="Max: 63 characters"/>	
Authentication Port	<input type="text" value="1812"/>	
Accounting Port	<input type="text" value="1813"/>	
Disconnect Message Port	<input type="text" value="3799"/>	
Interim Update Interval	<input type="text" value="10"/> min(s)(10~1440)	
Retry	<input type="text" value="2"/> times(1~3)	
<b>Secondary Server</b>		
-----		
Secondary Server	<input type="text" value="Max: 63 characters"/>	
Secret	<input type="text" value="Max: 63 characters"/>	
Authentication Port	<input type="text" value="1812"/>	
Accounting Port	<input type="text" value="1813"/>	
Disconnect Message Port	<input type="text" value="3799"/>	
Interim Update Interval	<input type="text" value="10"/> min(s)(10~1440)	
Retry	<input type="text" value="2"/> times(1~3)	
<b>Note:</b> If RADIUS server has specified Interim Update Interval value(Acct-Interim-Interval), Vigor Router will follow the interval that the RADIUS server provides and ignore the Interim Update Interval setting here.		
<input type="button" value="OK"/> <input type="button" value="Clear"/> <input type="button" value="Cancel"/>		
RADIUS Server Status Log		
<input type="button" value="Refresh"/> <input type="button" value="Clear"/> <hr/>		

Available settings are explained as follows:

Item	Description
Enable	<p>Check to enable RADIUS client profile.</p> <p>Comments - Enter a brief description for this profile.</p> <p>RADIUS Request Interval - Set a timeout value for the router waiting for a response from the RADIUS server. If no response, Vigor router will send the authentication request again.</p> <p>Enable Accounting - RADIUS Accounting is a network customer billing mechanism for RADIUS server.</p> <p>If enabled, Vigor router will deliver accounting request (e.g., IP address, traffic from the client) to the specified RADIUS server periodically.</p> <ul style="list-style-type: none"> <li>Accounting Port - Set the UDP port number (1813 in default) as the accounting port.</li> <li>Disconnect Message Port - Set a UDP port number (3799 in default) for receiving the</li> </ul>



	<p>disconnected-request packets from the AAA server. Note that these packets have been accepted by the RADIUS server before being disconnected by the AAA server.</p> <ul style="list-style-type: none"> <li>● <b>Interim Update Interval</b> - Set a value (10 minutes in default). It indicates the time between each transmittal of an interim update for a specific session.</li> </ul>
Primary Server	<p><b>Primary Server</b> - Enter the IP address of RADIUS server.</p> <p><b>Secret</b> - The RADIUS server and client share a secret that is used to authenticate the messages sent between them. Both sides must be configured to use the same shared secret. The maximum length of the shared secret you can set is 36 characters.</p> <p><b>Authentication Port</b> - The UDP port number that the RADIUS server is using. The default value is 1812, based on RFC 2138.</p> <p><b>Retry</b> - Set the number of attempts to perform reconnection with RADIUS server. If the connection (with the Primary Server) still fails, stop the connection attempt and begin to make connection with the secondary server.</p>
Secondary Server	<p><b>Secondary Server</b> - Enter the IP address of RADIUS server.</p> <p><b>Secret</b> - The RADIUS server and client share a secret that is used to authenticate the messages sent between them. Both sides must be configured to use the same shared secret. The maximum length of the shared secret you can set is 36 characters.</p> <p><b>Authentication Port</b> - The UDP port number that the RADIUS server is using. The default value is 1812, based on RFC 2138.</p> <p><b>Retry</b> - Set the number of attempts to perform reconnection. If the connection (with the Secondary Server) still fails, stop the connection attempt. The client authentication would be determined as "failed".</p>
RADIUS Server Status Log	Display the record of current status of RADIUS server.

To save changes on the page, click OK. To discard changes, click Cancel. To reset all settings to blank, click Clear.

## II-5-5-2 Internal RADIUS

Except for being a built-in RADIUS client, Vigor router also can be operated as a RADIUS server which performs security authentication by itself. This page is used to configure settings for internal RADIUS server. Then LAN user of Vigor router will be authenticated by Vigor router directly.

Select Internal RADIUS to configure the router's built-in RADIUS server.

External RADIUS
Internal RADIUS
External TACACS+

Enable

Authentication Port

**RADIUS Client Access List**

Index	Enable	Shared Secret	IP Address	IP Mask	IPv6 Address	IPv6 Length
1	<input type="checkbox"/>	Max: 31 character	0.0.0.0	0.0.0.0	::	0
2	<input type="checkbox"/>	Max: 31 character	0.0.0.0	0.0.0.0	::	0
3	<input type="checkbox"/>	Max: 31 character	0.0.0.0	0.0.0.0	::	0
4	<input type="checkbox"/>	Max: 31 character	0.0.0.0	0.0.0.0	::	0
5	<input type="checkbox"/>	Max: 31 character	0.0.0.0	0.0.0.0	::	0
6	<input type="checkbox"/>	Max: 31 character	0.0.0.0	0.0.0.0	::	0
7	<input type="checkbox"/>	Max: 31 character	0.0.0.0	0.0.0.0	::	0
8	<input type="checkbox"/>	Max: 31 character	0.0.0.0	0.0.0.0	::	0
9	<input type="checkbox"/>	Max: 31 character	0.0.0.0	0.0.0.0	::	0
10	<input type="checkbox"/>	Max: 31 character	0.0.0.0	0.0.0.0	::	0

**Authentication**

**Method**

**802.1X Method**

Support 802.1X Method

EAP\_TTLS/PAP    EAP\_TTLS/MSCHAP    EAP\_TTLS/MSCHAPv2

EAP\_PEAP/MSCHAPv2

Certificate

**User Profile**

**Available List**

**Authentication List**

Synchronize Internal RADIUS user list to Local 802.1X user list.

**Note:**

- Only the user profiles which is enabled in **User Management >> User Profile** will be listed here, and it shows in the **System Maintenance >> Internal Service User List**.
- RADIUS Client Access List is first match.

Available settings are explained as follows:

Item	Description
Enable	Select to enable the router's internal RADIUS server.
Authentication Port	The UDP port for authentication messages.
RADIUS Client Access List	<p>Only clients that meet the criteria configured in the access list are allowed to access the RADIUS server.</p> <p>Enable - Select to enable this client entry.</p> <p>Shared Secret - A text string that is known to both the router's RADIUS server and the RADIUS client that is used to authenticate messages sent between them. Maximum length is 36 characters.</p> <p>IP Address - Base address of the IP block.</p> <p>IP Mask - Enter the IP mask to configure the size of the IP</p>

	<p>block.</p> <p>IPv6 Address - Base address of the IPv6 block.</p> <p>IPv6 Length - The prefix length of the IPv6 block.</p>
<b>Authentication</b>	<p>Configures the authentication settings.</p> <p>Specify the way to authenticate the wireless client.</p> <p>PAP - Only the Password Authentication Protocol will be used to validate users.</p> <p>PAP/CHAP/MS-CHAP/MS-CHAPv2 - PAP, CHAP (Challenge-Handshake Authentication Protocol), and Microsoft versions of CHAP can be used to validate users.</p> <p>Support 802.1X Method - The built in RADIUS server offered by Vigor router can act as the AAA server. Select to enable 802.1X support.</p>
<b>User Profile</b>	<p>During the process of security authentication, user account and user password will be required for identity authentication. Before configuring such page, create at least one user profile in User Management&gt;&gt;User Profile first.</p> <p>Select All - Click to move all user profiles under the Available List to the Authentication List.</p> <p>Clear All - Click to remove all user profiles from the Authentication List.</p> <p>Available List - The user profiles without RADIUS server enabled in User Management &gt;&gt; User Profile will be listed in this field.</p> <p>Authentication List -The user profiles with RADIUS server enabled in User Management &gt;&gt; User Profile will be listed in this field.</p>
<b>Synchronize Internal RADIUS user list to Local 802.1X user list</b>	<p>Users can be authenticated by RADIUS server and local 802.1X to get certain network service. It is not necessary to create new user profiles (containing user accounts and user passwords) for RADIUS and local 802.1X respectively.</p> <p>Simply select to update the 802.1X authentication list to match the RADIUS authentication list.</p>

To add a User Profile to the RADIUS server, select it under Available List, then click the >> button. To remove a User Profile from the RADIUS server, select it under Selected Authentication List, then click the << button.

To save changes on the page, click OK. To discard changes, click Cancel. To reset all settings to blank, click Clear.

## II-5-5-3 External TACACS+

It means Terminal Access Controller Access-Control System Plus. It works like RADIUS does. Click the External TACACS+ to open the following page:

Applications >> RADIUS/TACACS+

External RADIUS Internal RADIUS External TACACS+

Enable

**Primary Server**

Server IP Address  Max: 15 characters

Destination Port

Type  ▼

Shared Secret  Max: 36 characters

Confirm Shared Secret  Max: 36 characters

**Secondary Server**

Server IP Address  Max: 15 characters

Destination Port

Type  ▼

Shared Secret  Max: 36 characters

Confirm Shared Secret  Max: 36 characters

OK Clear Cancel

Available settings are explained as follows:

Item	Description
Enable	Select to enable the use of an external TACACS+ server.
Primary Server / Secondary Server	Two external TACACS+ servers are allowed to set in this page. The secondary TACACS+ server will be used as a backup server when the primary TACACS+ server is down.
Server IP Address	The IP address of the TACACS+ server.
Destination Port	The port used by the TACACS+ server. Port 49 is most common.
Shared Secret	A text string that is known to both the TACACS+ server and client (the router) that is used to authenticate messages sent between them. Maximum length is 36 characters.
Confirm Shared Secret	Enter the shared secret again for verification.

To save changes on the page, click OK. To discard changes, click Cancel. To reset all settings to blank, click Clear.

## II-5-6 Active Directory/LDAP

Lightweight Directory Access Protocol (LDAP) is an industry-standard protocol for maintaining and accessing directory information on a network. When used in conjunction with a Vigor router, LDAP can be used to authenticate VPN connection attempts.

Active Directory (AD) is a directory service from Microsoft that supports LDAP queries.

To configure Active Directory or LDAP settings, from the Main Menu select Applications >> Active Directory /LDAP.

### II-5-6-1 General Setup

To configure the settings for the LDAP server, select General Setup.

Applications >> Active Directory / LDAP

[Set to Factory Default](#)

Enable

Bind Type:

Server Address:

Destination Port:   Use SSL

Regular DN:

Regular Password:

Active Directory / LDAP Profiles

Index	Name	Distinguished Name
1.		
2.		
3.		
4.		
5.		
6.		
7.		
8.		

Available settings are explained as follows:

Item	Description
Enable	Select to enable LDAP client. If enabled, the LDAP profiles will be available for configuration.
Bind Type	Select from one of 3 bind types: <ul style="list-style-type: none"> <li>● Simple Mode - Initiate bind operation (authentication) without performing user search. This mode can be used when all users belong to the same branch in the LDAP structure.</li> <li>● Anonymous - Bind anonymously, without supplying the</li> </ul>

	<p>distinguished name (DN) and password, and perform user search. This mode can be used when not all users belong to the same branch and the server allows anonymous searches.</p> <ul style="list-style-type: none"> <li>● Regular Mode - Same as Anonymous mode, except that the DN and password are sent to the server. This mode can be used when not all users belong to the same branch and the server does not allow anonymous searches.</li> </ul> <p>For the regular mode, you'll need to Enter the Regular DN and Regular Password.</p>
Server Address	The network address of the LDAP server.
Destination Port	The network port that the LDAP server listens on. The default ports are 389 for unsecured connections and 636 for LDAPS (LDAP over SSL) connections.
Use SSL	Select to use Secure Sockets Layer (SSL) for LDAP traffic.
Regular DN	Enter the LDAP Distinguished Name for authentication if Bind Type is set to Regular Mode.
Regular Password	Enter the LDAP Password for authentication if Bind Type is set to Regular Mode.
Active Directory / LDAP Profiles	Up to 8 LDAP profiles can be created. These profiles would be used with User Management for different purposes in management.



To save changes on the page, select OK; to discard changes, select Cancel.

## II-5-6-2 Active Directory / LDAP Profiles

To configure an LDAP profile, click on its index to show the following settings page.

Applications >> Active Directory /LDAP>>Server Profiles

### Index No. 1



Name	<input type="text" value="RD1"/>
Common Name Identifier	<input type="text" value="UD1"/>
Base Distinguished Name	<input type="text"/> 
Additional Filter	<input type="text"/>
Group Distinguished Name	<input type="text"/> 

**Note:**

Please type in your additional filter for BaseDN search request. For example, "gidNumber=500" for OpenLDAP, and "msNPAllowDialin=TRUE" for AD.

Available settings are explained as follows:

Item	Description
Name	Name that identifies this profile. Maximum length is 19 characters.
Common Name Identifier	The common name attribute, which is typically "cn" in most LDAP configurations.
Base Distinguished Name	The starting point of user search in the LDAP directory, for

	<p>example, dc=draytek,dc=com.</p> <p> - click this icon to display a list of valid DNs in the LDAP directory.</p>
<b>Additional Filter</b>	<p>Additional filter to be applied to the search request to identify eligible users.</p> <p>For example,</p> <ul style="list-style-type: none"> <li>- “OpenLDAP: (gidNumber=500)”</li> </ul> <p>Here group ID 500 is the group of dial-in users.</p> <ul style="list-style-type: none"> <li>- “ActiveDirectory: (msNPAllowDialin=TRUE)”</li> </ul> <p>The msNPAllowDialin attribute indicates that the user has permission to dial in remotely.</p>
<b>Group Distinguished Name</b>	<p>The base DN of the tree in the LDAP directory that contains groups, for example, ou=groups,dc=draytek,dc=com.</p> <p> - click this icon to display a list of valid DNs in the LDAP directory.</p>

To save changes on the page, select OK; to discard changes, select Cancel.

## II-5-7 UPnP

To configure UPnP settings, from the Main Menu select **Applications >> UPnP**.

**Applications >> UPnP**

**UPnP**

Enable UPnP Service

Enable Connection Control Service

Enable Connection Status Service

Default WAN ▾

Default WAN

WAN1

WAN2

WAN3

WAN4

LTE

WAN6

**Note:**  
To allow NAT pass-through to a UPnP enabled client the connection control service must also be enabled.

OK Clear Cancel

Available settings are explained as follows:

Item	Description
Enable UPnP Service	Select to enable UPnP.
Default WAN	Select the WAN port on which ports will be opened in response to UPnP commands.
Enable Connection Control Service	Select to enable the connection control service.
Enable Connection Status Service	Select to enable the connection status service.

To save changes on the page, select **OK**; to discard changes, select **Cancel**; to revert all settings to the factory default, select **Clear**.

The reminder as regards concern about Firewall and UPnP:

### Can't work with Firewall Software

Enabling firewall applications on your PC may cause the UPnP function not working properly. This is because these applications will block the accessing ability of some network ports.

### Security Considerations

Activating UPnP allows any application or network devices to open ports on the WAN side to allow connections to the LAN, which could compromise network security. Also if UPnP applications or network devices malfunction or terminate abnormally, the opened ports may remain open indefinitely, and thus increasing the chance of it getting exploited by malicious parties.

If you do not have applications or network devices which requires UPnP, you are advised to disable UPnP.



### Info

UPnP is required for some applications such as PPS, Skype, eMule...and etc. If you are not familiar with UPnP, it is suggested to turn off this function for security.



## II-5-8 IGMP

Internet Group Management Protocol (IGMP) is an IPv4 communication protocol for establishing multicast group memberships.

To configure IGMP settings, from the Main Menu select **Applications >> IGMP**.

### II-5-8-1 General Setting

Applications >> IGMP

General setting	Working status
<input checked="" type="checkbox"/> <b>IGMP Proxy</b> IGMP Proxy acts as a multicast proxy for hosts on the LAN side. Enable IGMP proxy to access any multicast group. This function <b>takes no effect when Bridge Mode is enabled</b> .	
Interface	WAN1
IGMP version	Auto
General Query Interval	125 (seconds)
Add PPP header (Encapsulate IGMP in PPPoE)	<input type="checkbox"/>
Enable IGMP syslog	<input type="checkbox"/>
<input checked="" type="checkbox"/> <b>IGMP Snooping</b> Enable: Forwards multicast traffic only to ports that are members of that group. Disable: Treats multicast traffic the same as broadcast traffic.	
<input type="checkbox"/> <b>IGMP Fast Leave</b> The router stops forwarding multicast traffic to a LAN port as soon as it receives a leave message from that port. Each LAN port should have no more than one IGMP host connected.	
IGMP Accept List	IP Object None
Only allow the IP of the LAN device to be included in the specified object/group to use IGMP.	
<input type="button" value="OK"/> <input type="button" value="Cancel"/>	

Available settings are explained as follows:

Item	Description
IGMP Proxy	<p>Check this box to enable this function. The application of multicast will be executed through WAN /PVC/VLAN port. In addition, such function is available in NAT mode.</p> <p><b>Interface</b> - Specify an interface for packets passing through.</p> <p><b>IGMP version</b> - At present, two versions (v2 and v3) are supported by Vigor router. Choose the correct version based on the IPTV service you subscribe.</p> <p><b>General Query Interval</b> - Vigor router will periodically check which IP obtaining IPTV service by sending query. It might cause inconvenience for client. Therefore, set a suitable time (unit: second) as the query interval to limit the frequency of query sent by Vigor router.</p> <p><b>Add PPP header</b> - Check this box if the interface type for IGMP is PVC/VLAN. It depends on the specifications regulated by each ISP. If you have no idea to enable or disable, simply contact your ISP providers.</p> <p><b>Enable IGMP syslog</b> - Check the box to store the IGMP status onto Syslog.</p>

IGMP Snooping	Select to enable IGMP Snooping so that multicast traffic are forwarded to IGMP clients that have joined a multicast group.
IGMP Fast Leave	This option is shown only when IGMP Snooping is enabled. Select to enable IGMP Fast Leave. Normally when the router receives a “leave” message from an IGMP host, it will send a last member query message to see if there are still members within the multicast group. When Fast Leave is enabled, multicast for a group is immediately terminated when the last host in that group sends a “leave” message.
IGMP Accept List	Select IP Object or IP Group. Only the IP of the LAN device within the IP object / IP group will be allowed to use IGMP.

To save changes on the page, select OK; to discard changes, select Cancel.

## II-5-8-2 Working Status

Displays a list of active multicast groups.

Applications >> IGMP

General setting		Working status				
						<a href="#">Refresh</a>
Multicast Group Table						
Index	Group ID	P1	P2	P3	P4	P5
IGMP Device Table						
Index	MAC Address	IP Address	Interface	IGMP Version		
IGMP Block Table						
Index	IP Range	Unblock				
<input type="button" value="OK"/>						

Available settings are explained as follows:

Item	Description
Refresh	Click to reload the Multicast Group Table with the latest information.
Index	Index number of the multicast group.
Group ID	ID port of the multicast group, which is within the IP range reserved for IGMP, 224.0.0.0 through 239.255.255.254.
P1 to P5	LAN ports that have IGMP hosts joined to this multicast group.

## II-5-9 Wake on LAN/WAN

### II-5-9-1 Wake on LAN

Using the Wake on LAN (WoL) feature, LAN clients that support WoL can be powered on or resume from sleep over the network, without the need for physical access to the device.

In order for LAN clients to be able to wake from sleep or off states, the network interface card must be configured to monitor Wake-on-LAN messages. Consult the documentation of the LAN client for details on setting up its network interface for Wake on LAN.

If you wish to be able to select the IP address of the Wake-on-LAN client, its MAC address must first be bound to a static IP address using the Bind IP to MAC function.

To configure Wake on LAN settings, from the Main Menu select **Applications >> Wake on LAN**.

**Applications >> Wake on LAN/WAN**

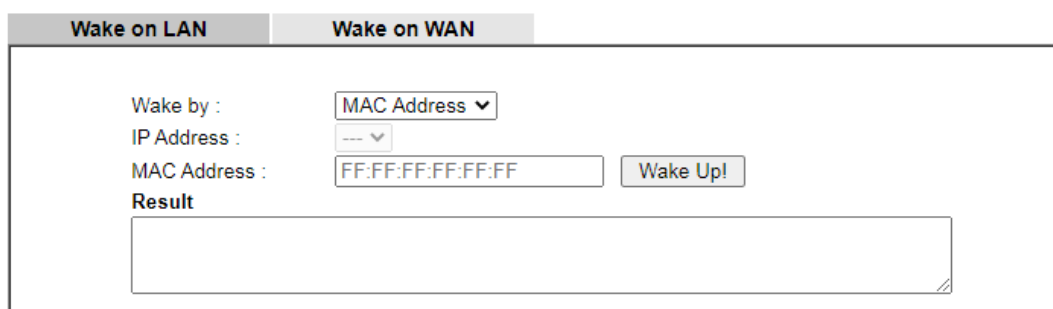

**Note:**

Wake on LAN integrates with [Bind IP to MAC](#) function; only bound PCs can wake up through IP.

Available settings are explained as follows:

Item	Description
Wake by	Two types provide for you to wake up the binded IP. <ul style="list-style-type: none"><li>● If you choose Wake by MAC Address, you have to Enter the correct MAC address of the host in MAC Address boxes.</li><li>● If you choose Wake by IP Address, you have to choose the correct IP address.</li></ul>
IP Address	The IP addresses that have been configured in Firewall>>Bind IP to MAC will be shown in this drop down list. Choose the IP address from the drop down list that you want to wake up.
MAC Address	Type any one of the MAC address of the bound PCs.
Wake Up	Click this button to wake up the selected IP. See the following figure. The result will be shown on the box.
Result	Result of the transmission of the Wake-on-LAN message.

## II-5-9-2 Wake on WAN

To configure Wake on WAN settings, from the Main Menu select Applications >> Wake on LAN and select the tab of Wake on WAN.

Applications >> Wake on LAN/WAN

Wake on LAN
Wake on WAN

Enable Wake on WAN

Allow Wake on WAN from

Any WAN IP

Access List

Access List | [Set to Factory Default](#) |

Index	IP Address	Subnet Mask
1	0.0.0.0	0.0.0.0
2	0.0.0.0	0.0.0.0
3	0.0.0.0	0.0.0.0

Available settings are explained as follows:

Item	Description
Enable Wake on WAN	Select to enable the function.
Allow Wake on WAN from	<p>Set the path for the boot packet (sent by a mobile phone) to deliver to the remote device.</p> <p>Any WAN IP - Any WAN IP can be used as a path for waking the remote device.</p> <p>Access List - Enter the WAN IP address with the subnet mask. Later, use your mobile phone (installing an APP for sending the boot packets first) to connect to the Vigor router network. The boot packets will be transferred to the remote device via any WAN IP or the IP listed on Access List.</p>

## II-5-10 SMS / Mail Alert Service

The function of SMS (Short Message Service)/Mail Alert is that Vigor router sends a message to user's mobile or e-mail box through specified service provider to assist the user knowing the real-time abnormal situations.

Vigor router allows you to set up to 10 SMS profiles which will be sent out according to different conditions.

### II-5-10-1 SMS Alert

This page allows you to specify SMS provider, who will get the SMS, what the content is and when the SMS will be sent.

Applications >> SMS / Mail Alert Service

SMS Alert		Mail Alert		<a href="#">Set to Factory Default</a>	
Index	Enable	SMS Provider	Recipient Number	Notify Profile	Schedule(1-15)
1	<input type="checkbox"/>	1 - ???		1 - ???	None
2	<input type="checkbox"/>	1 - ???		1 - ???	None
3	<input type="checkbox"/>	1 - ???		1 - ???	None
4	<input type="checkbox"/>	1 - ???		1 - ???	None
5	<input type="checkbox"/>	1 - ???		1 - ???	None
6	<input type="checkbox"/>	1 - ???		1 - ???	None
7	<input type="checkbox"/>	1 - ???		1 - ???	None
8	<input type="checkbox"/>	1 - ???		1 - ???	None
9	<input type="checkbox"/>	1 - ???		1 - ???	None
10	<input type="checkbox"/>	1 - ???		1 - ???	None

Note:

All the SMS Alert profiles share the same "Sending Interval" setting if they use the same SMS Provider.

Available settings are explained as follows:

Item	Description
Enable	Check the box to enable or disable the profile.
SMS Provider	Use the drop down list to choose SMS service provider. You can click SMS Provider link to define the SMS server.
Recipient Number	Enter the phone number of the one who will receive the SMS.
Notify Profile	Use the drop down list to choose a message profile. The recipient will get the content stated in the message profile. You can click the Notify Profile link to define the content of the SMS.
Schedule (1-15)	Enter the schedule number that the SMS will be sent out. You can click the Schedule(1-15) link to define the schedule.

After finishing all the settings here, please click OK to save the configuration.

## II-5-10-2 Mail Alert

This page allows you to specify Mail Server profile, who will get the notification e-mail, what the content is and when the message will be sent.

Application >> SMS / Mail Alert Service

SMS Alert		Mail Alert		Set to Factory Default	
Index	Enable	Mail Service	Mail Address	Notify Profile	Schedule(1-15)
1	<input type="checkbox"/>	1 - ??? ▾		1 - ??? ▾	None ▾ None ▾
2	<input type="checkbox"/>	1 - ??? ▾		1 - ??? ▾	None ▾ None ▾
3	<input type="checkbox"/>	1 - ??? ▾		1 - ??? ▾	None ▾ None ▾
4	<input type="checkbox"/>	1 - ??? ▾		1 - ??? ▾	None ▾ None ▾
5	<input type="checkbox"/>	1 - ??? ▾		1 - ??? ▾	None ▾ None ▾
6	<input type="checkbox"/>	1 - ??? ▾		1 - ??? ▾	None ▾ None ▾
7	<input type="checkbox"/>	1 - ??? ▾		1 - ??? ▾	None ▾ None ▾
8	<input type="checkbox"/>	1 - ??? ▾		1 - ??? ▾	None ▾ None ▾
9	<input type="checkbox"/>	1 - ??? ▾		1 - ??? ▾	None ▾ None ▾
10	<input type="checkbox"/>	1 - ??? ▾		1 - ??? ▾	None ▾ None ▾

Note:

All the Mail Alert profiles share the same "Sending Interval" setting if they use the same Mail Server.

OK Cancel

Available settings are explained as follows:

Item	Description
Enable	Check the box to enable / disable this profile.
Mail Service	Use the drop down list to choose mail service object. All of the available objects are created in Object Settings>>SMS/Mail Service Object. If there is no object listed, click Mail Service link to define a new one with specified service provider.
Mail Address	Enter the e-mail address of the one who will receive the notification message.
Notify Profile	Use the drop down list to choose a message profile. The recipient will get the content stated in the message profile. You can click the Notify Profile link to define the content of the mail message.
Schedule (1-15)	Enter the schedule number that the notification will be sent out. You can click the Schedule(1-15) link to define the schedule.

After finishing all the settings here, please click OK to save the configuration.

## II-5-11 Bonjour

Bonjour is a service discovery protocol which is a built-in service in Mac OS X; for Windows or Linux platform, there is correspondent software to enable this function for free.

Usually, users have to configure the router or personal computers to use above services. Sometimes, the configuration (e.g., IP settings, port number) is complicated and not easy to complete. The purpose of Bonjour is to decrease the settings configuration (e.g., IP setting). If the host and user's computer have the plug-in Bonjour driver install, they can utilize the service offered by the router by clicking the router name icon. In short, what the Clients/users need to know is the name of the router only.

To enable the Bonjour service, click **Application>>Bonjour** to open the following page. Check the box(es) of the server service(s) that you want to share to the LAN clients.

Applications >> Bonjour ?

---

**Bonjour Setup**

Enable Bonjour Service

- HTTP Server
- Telnet Server
- FTP Server
- SSH Server
- LPR Printer Server

Available settings are explained as follows:

Item	Description
Enable Bonjour Service	Select to enable the Bonjour service on the router. The rest of the checkboxes will be enabled for selection when this checkbox has been selected.
HTTP Server	Select to allow the router's HTTP server to be discovered via Bonjour.
Telnet Server	Select to allow the router's telnet server to be discovered via Bonjour.
FTP Server	Select to allow the router's FTP server to be discovered via Bonjour.
SSH Server	Select to allow the router's SSH server to be discovered via Bonjour.
LPR Print Server	Select to allow the router's LPR server to be discovered via Bonjour. This allows printers attached to the router's USB ports to be discovered.

Below shows an example for applying the Bonjour feature that Vigor router can be used as the FTP server.

1. Here, we use Firefox and DNSSD to discover the service in such case. Therefore, just ensure the Bonjour client program and DNSSD for Firefox have been installed on the computer.

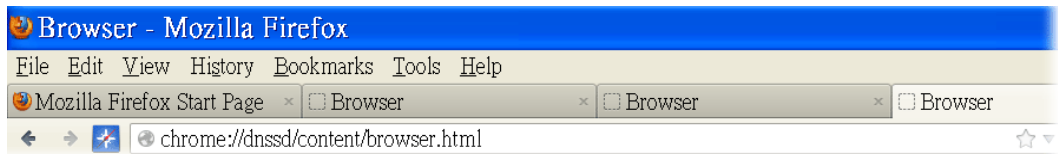

- Open the web browser, Firefox. If Bonjour and DNSSD have been installed, you can open the web page (DNSSD) and see the following results.

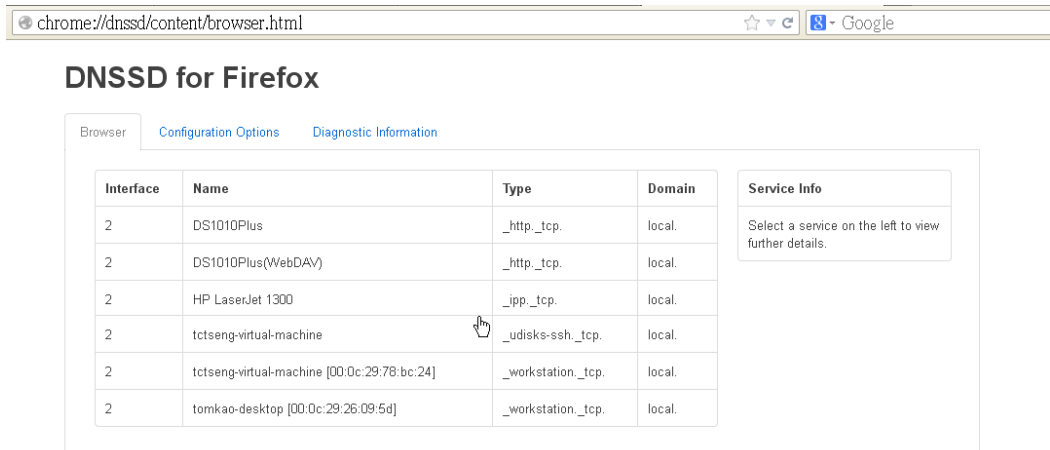

- Open System Maintenance>>Management. Type a name as the Router Name and click OK.

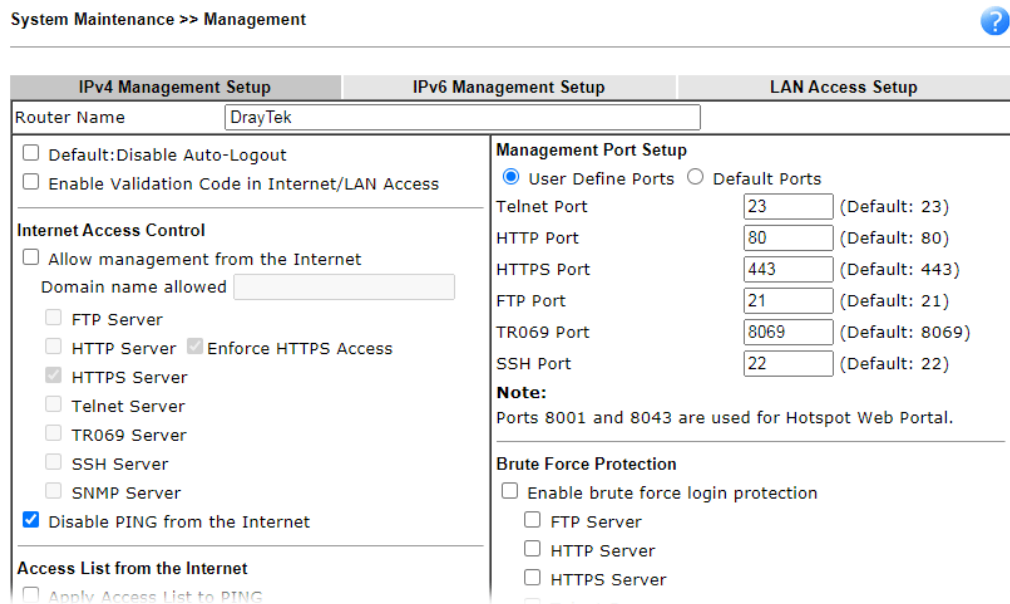

- Next, open Applications>>Bonjour. Check the service that you want to use via Bonjour.





## Bonjour Setup

<input checked="" type="checkbox"/>	Enable Bonjour Service
<input checked="" type="checkbox"/>	HTTP Server
<input checked="" type="checkbox"/>	Telnet Server
<input checked="" type="checkbox"/>	FTP Server
<input checked="" type="checkbox"/>	SSH Server
<input checked="" type="checkbox"/>	LPR Printer Server

OK

Cancel

5. Open the DNSSD page again. The available items will be changed as the follows. It means the Vigor router (based on Bonjour protocol) is ready to be used as a printer server, FTP server, SSH Server, Telnet Server, and HTTP Server.

chrome://dnssd/content/browser.html ☆ Google

## DNSSD for Firefox

Browser Configuration Options Diagnostic Information

Interface	Name	Type	Domain	Service Info
2	DS1010Plus	_http._tcp.	local.	Select a service on the left to view further details.
2	DS1010Plus(WebDAV)	_http._tcp.	local.	
2	HP LaserJet 1300	_ipp._tcp.	local.	
2	Vigor Router	_ftp._tcp.	local.	
2	Vigor Router	_http._tcp.	local.	
2	Vigor Router	_printer._tcp.	local.	
2	Vigor Router	_ssh._tcp.	local.	
2	Vigor Router	_telnet._tcp.	local.	
2	tcseng-virtual-machine	_udisks-ssh._tcp.	local.	
2	tcseng-virtual-machine [00:0c:29:78:bc:24]	_workstation._tcp.	local.	
2	tomkao-desktop [00:0c:29:26:09:5d]	_workstation._tcp.	local.	

6. Now, any page or document can be printed out through Vigor router (installed with a printer).

**Print**

Printer

Name: Microsoft XPS Document Writer Properties...

Status: Auto HP LaserJet 1200 Series PCL on RD-KC

Type: Auto Microsoft XPS Document Writer on RD-KC

Location: Auto Microsoft XPS Document Writer on TIM-PC

Comment: Vigor Router

Print to file

Print range:  All pages  Pages   Selection

Copies: Number of copies: 1  Collate

Options... OK Cancel Help

---

## II-5-12 High Availability

The High Availability (HA) feature of the router provides redundancy of network resources, and reduces downtime in case of component failure. The level of sophistication of HA is determined by availability requirements and tolerance of system interruptions. Systems that provide near full-time availability typically have redundant hardware and software.

The HA of the Vigor2927 Series is designed to avoid single points-of-failure. When failures occur, the failover process transfers the network load handled by the failed component (the primary router) to the backup component (the secondary router), and the availability of network resources are preserved and partially failed transactions are recovered. In a matter of seconds the system returns to normal operation.

In order to set up High Availability, at least 2 DrayTek routers have to be configured in the following manner:

- Enable High Availability on both the primary and secondary routers.
- Set a high priority ID on the primary router, and a lower priority ID on the secondary router.
- Configure identical redundancy methods, group IDs, and authentication keys on both routers.
- Set the management interface of both routers to the same subnet.
- Enable virtual IP on both routers for each subnet in use. Make sure the virtual IPs are identical on both routers.

## II-5-12-1 General Setup

Open Applications>>High Availability to bring up the configuration page to configure High Availability.

Applications >> High Availability



Enable High Availability

Redundancy Method

General Setup	Config Sync	Status	Set to Factory Default
Group ID	<input type="text" value="1"/> (1-255)		
Priority ID	<input type="text" value="10"/> (1-30, 30 is highest priority)		
Authentication Key	<input type="text" value="draytek"/>		
Protocol	<input type="text" value="IPv4"/>		
Management Interface	<input type="text" value="LAN1"/>		
<u>Update DDNS</u>	<input type="checkbox"/> Enable		
Syslog	<input type="checkbox"/> Enable		

IPv4	IPv6
<b>Index</b>	<b>Enable</b>
LAN1	<input type="checkbox"/>
LAN2	<input type="checkbox"/>
LAN3	<input type="checkbox"/>
LAN4	<input type="checkbox"/>
LAN5	<input type="checkbox"/>
LAN6	<input type="checkbox"/>
LAN7	<input type="checkbox"/>
LAN8	<input type="checkbox"/>
DMZ	<input type="checkbox"/>

Index	Enable	Virtual IP
LAN1	<input type="checkbox"/>	<input type="text" value="192.168.1.2"/>
LAN2	<input type="checkbox"/>	<input type="text" value="192.168.2.2"/> !
LAN3	<input type="checkbox"/>	<input type="text" value="192.168.3.2"/> !
LAN4	<input type="checkbox"/>	<input type="text" value="192.168.4.2"/> !
LAN5	<input type="checkbox"/>	<input type="text" value="192.168.5.2"/> !
LAN6	<input type="checkbox"/>	<input type="text" value="192.168.6.2"/> !
LAN7	<input type="checkbox"/>	<input type="text" value="192.168.7.2"/> !
LAN8	<input type="checkbox"/>	<input type="text" value="192.168.8.2"/> !
DMZ	<input type="checkbox"/>	<input type="text" value="192.168.254.2"/> !

**Note:**

To configure High Availability on at least two DrayTek routers:

- Enable High Availability on the Primary and Secondary routers.
- Set a high Priority ID number on the Primary router and lower numbers for the Secondary router(s).
- Set the same Redundancy Method / Group ID / Authentication Key on the Primary and Secondary routers.
- Set the Management Interface to the same subnet for the Primary and Secondary routers.
- Enable Virtual IP on the Primary and Secondary routers for each subnet in use and set the same Virtual IP on each router.

Available settings are explained as follows:

Item	Description
Enable High Availability	Check this box to enable HA function.
Redundancy Method	Select the redundancy method for high availability. <b>Hot-Standby -</b> This method is suitable when there is only one ISP account. When this method is selected, <ul style="list-style-type: none"> <li>● During normal operation the secondary router will be idling. When the primary router fails to operate normally, the secondary router(s) will take over.</li> <li>● WAN settings of the primary and secondary routers are identical.</li> </ul>

	<p>Note: When Hot-Standby is used, the wireless LAN function on secondary router will be “disabled” directly. Clients can not connect to the secondary router any more.</p> <p>Active-Standby - This method is suitable when there are multiple simultaneously active ISP connections. When this method is selected,</p> <ul style="list-style-type: none"> <li>● All WANs on the secondary routers can be up at the same time. LANs that are not configured under high availability can be routed to secondary routers.</li> <li>● WAN settings of primary and secondary routers are independently configured.</li> <li>● Config Sync may be enabled to synchronize most configuration settings between the primary and secondary routers.</li> <li>● All routers must be set to the same redundancy method.</li> </ul>
Group ID	<p>Enter a value (1-255).</p> <p>In LAN environment, multiple routers can be divided into several groups. Each router must be specified with one group ID. Different routers with the same ID value will be categorized into the same group.</p> <p>Only one of the routers in the same group will be selected as the primary router.</p>
Priority ID	<p>Enter a value (1-30).</p> <p>Different routers must be configured with different IDs.</p> <p>All routers within a group must be assigned a priority ID. Within a group, the router with the largest priority ID (i.e., the highest priority) will be the primary router. When multiple routers in a group are assigned the same priority ID, routers with lower LAN IP addresses (configured on the LAN &gt;&gt; General Setup page) have higher priority.</p>
Authentication Key	<p>Enter an authentication key up to 31 characters long. This is used to encrypt the DARP (DrayTek Address Redundancy Protocol) traffic to guard against malicious attacks.</p>
Protocol	<p>Select the IP protocol to be used for DARP.</p>
Management Interface	<p>Select the interface to be used for DARP negotiation between routers. Only interfaces which are enabled in LAN&gt;&gt;General Setup are available for selection.</p> <p>However, LAN1 is always enabled.</p>
Update DDNS	<p>Enable - Check the box to update the DDNS server for the secondary device when the primary router fails.</p> <p>If the primary device fails, and the secondary device must take over the job of data transmitting and receiving. Then the system will update the DDNS server to make the user connect to the specified domain name.</p>
Syslog	<p>Enable - Check the box to record required information on Syslog.</p>
LAN1 ~ LAN8, DMZ	<p>Enable - Check the box to enable the interface.</p> <p>Virtual IP - Enter the IP address of the router plays the role of Primary device.</p>

When you finish the configuration, please click OK to save and exit this page.

## II-5-12-2 Config Sync

This page is used to specify the synchronization time for such Vigor router.

Applications >> High Availability



Enable High Availability

Redundancy Method

General Setup	Config Sync	Status	Set to Factory Default
<input type="checkbox"/> Enable Config Sync ( Max. Sync to 10 routers )			
Config Sync Interval:			
Day <input type="text" value="0"/>			
Hour <input type="text" value="0"/>			
Minute <input type="text" value="15"/>			
Exclude the following settings from config sync:			
<input checked="" type="checkbox"/> WAN Settings			
<input type="checkbox"/> Config Inherit from the previous master device after failback Resync the config when the device has acted as 2nd master for <input type="text" value="5"/> Minute			

**Note:**

1. This feature requires that both routers are the same series, and the High Availability must be enabled for Config Sync to operate.
2. The following settings will not be synced: LAN setting, High Availability setting, Router Name, Administrator and User Password.

Available settings are explained as follows:

Item	Description
Enable Config Sync (Max. Sync to 10 routers)	Check this box to enable configuration synchronization. To sync configuration from primary to secondary router, both primary and secondary routers need to enable "config sync". Note that config sync can be enabled by Hot-Standby redundancy method only.
Config Sync Interval	Day / Hour / Minute - The primary router will synchronize its configuration with secondary routers at every specified time interval.
Exclude the following settings from config sync	This setting is available when the Redundancy Method is set to Hot Standby. Select the configuration settings to be excluded from synchronization.
Config Inherit from the previous master device after failback	The configuration inherits will be executed only when the device (router) plays the role of the master device. Once another device with the priority ID higher than this device is ready to take over the management as the master device, after acting as the primary master for a while, this device will sync the configuration to all members in the same group and return to the role of the backup device (secondary master). Config Inherit... for ( ) minute - Enter a value.

When you finish the configuration, please click OK to save and exit this page.

When the configuration method is set to “Hot Standby”, the following settings will not be synchronized:

- WAN (user selectable)
- LAN
- LAN IPv6
- router name
- admin and user passwords

Example:

In the following example, the first Vigor2927 is configured as the primary device, and the other Vigor2927 is the secondary device. When the primary Vigor2927 breaks down, the secondary device assumes the role of the primary device by taking over all responsibilities as soon as possible. However, when the primary device recovers, the secondary device will once again be the standby device.

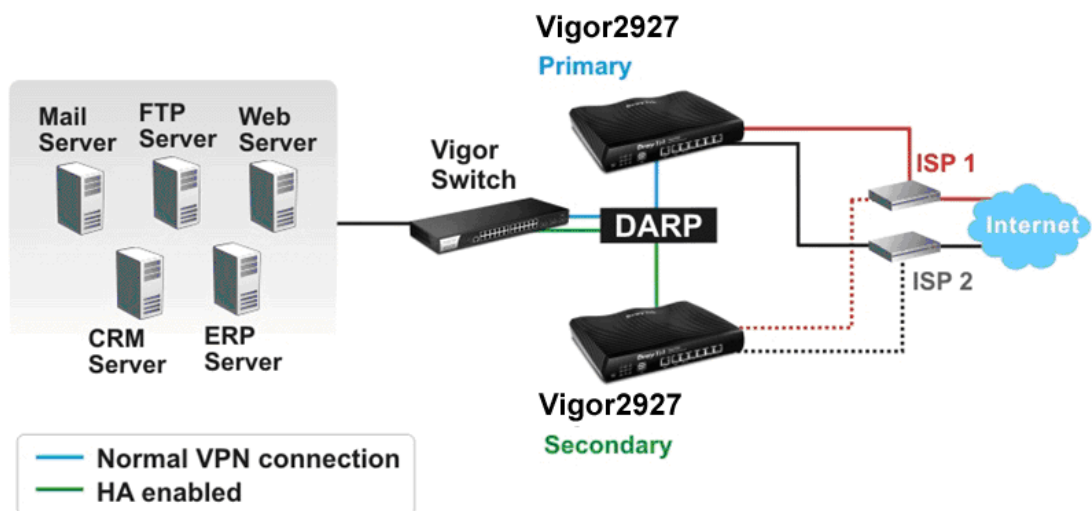

## II-5-13 Local 802.1X General Setup

Such page allows you to configure general settings for Local 802.1X server built in Vigor router. The local 802.X server can be used to authenticate wired and wireless LAN clients.

Applications >> Local 802.1X General Setup

Local 802.1X General Setup

Enable

EAP\_TTLS/PAP    EAP\_TTLS/MSCHAP    EAP\_TTLS/MSCHAPv2  
 EAP\_PEAP/MSCHAPv2

Certificate

Default Certificate ▾

User Profile

Select All   Clear All

Available List   Authentication List

Sync User Profile Setting to Internal Radius



**Note:**

1. Only the user profiles which is enabled in **User Management >> User Profile** will be listed here.
2. **Wireless LAN(2.4G)**, **Wireless LAN(5G)** and **Wired 802.1X** used the same **User Profile** as its identity and password.

OK   Cancel

Available settings are explained as follows:

Item	Description
Enable	Click it to enable the built-in 802.1X server. At present, such feature can be used for wireless and wired 802.1x authentication.
Certificate	Select a certificate for the user profiles. Usually, the self-signed certificate will be used as the default certificate. If there are many local / trusted certificates, select one of the certificates if required.
User Profile	Select All - Click to add all User Profiles to the 802.1X server. All profiles will appear under the Authentication List. Clear All - Remove all user profiles from the 802.1X server. All profiles will appear under Available List.
Sync User Profile ....	Make the enabling/disabling setting for both Internal RADIUS and Local 802.1X synchronize for all of the user profiles (User Management>>User Profile). For example, if Local 802.1x is configured as Enabled (checked), the Internal RADIUS will be configured as Enabled

	<p>too.</p>  <p>If Local 802.1X is configured as Disabled (unchecked), the Internal RADIUS will be changed as Disabled too, even if it is enabled previously.</p> 
OK	Click it to save the settings.
Cancel	Click it to give up all settings configuration.

When you finish the configuration, please click OK to save and exit this page.



# Application Notes

## A-1 How to use DrayDDNS?

Vigor router supports various DDNS service providers, user can set up user-defined profile to update the DDNS even the service provider is not on the list. Now, DrayTek starts to support our own DDNS service - DrayDDNS. We will provide a domain name for each Vigor Router, this single domain name can record IP addresses of all WAN.

### Activate DrayDDNS License

1. Go to Wizards >> Service Activation Wizard, wait for the router to connect to MyVigor server, then tick DT-DDNS and I have read and accept the above Agreement, click Next.

Service Activation Wizard

Select the service type that you want to activate

Activation Date : 2017-02-23

**Web Content Filter(WCF) Service :**

BPJM [License Agreement](#)  
This is a web content filter that is provided by the German government. It is a free service without any guarantee and will expire one year after activation. You may re-activate the service after expiry.

Cyren 30-Days Free Trial [License Agreement](#)  
This is a worldwide web content filter service. The free trail license can only be used once. At the end of the free trail period you may purchase the official one-year Cyren Web Content Filter from an authorized DrayTek reseller.

**APP Enforcement(APPE) Service :**

DT-APPE [License Agreement](#)  
Upgrade APPE Signature automatically.

**Dynamic DNS(DDNS) Service :**

DT-DDNS [License Agreement](#)  
This is a Dynamic Domain Name Service that is provided by DrayTek company. It is a free service will expire 1 year after activation. You may re-activate the service after expiry.

Domain Name : .drayddns.com

**\* Please note that the DrayDDNS service is currently for internal use only.**

---

I have read and accept the above Agreement. (Please check this box).

2. Confirm the information, then click Activate.

### Service Activation Wizard

Please confirm your settings

Service Type : Trial version  
Service Activated : Dynamic DNS ( [www.drayddns.com](http://www.drayddns.com) )

Please click **Back** to re-select service type you to activate.

< Back    Activate    Cancel

3. MyVigor server will reply with the service activation information.

### DrayTek Service Activation

Service Name	Start Date	Expire Date	Status
Web Content filter	---	---	Not Activated
APP Enforcement	---	---	Not Activated
DDNS	2017-02-23	2018-02-23	DT-DDNS

Please check if the license fits with the service provider of your signature. To ensure normal operation for your router, update your signature again is recommended.

### Configure DDNS Profile

1. Go to Applications >> Dynamic DNS Setup,
  - a. Tick Enable Dynamic DNS Setup
  - b. Click an available profile index
  - c. Tick Enable Dynamic DNS Account
  - d. Select DrayDDNS Global ([www.drayddns.com](http://www.drayddns.com)) as Service Provider
  - e. Select the WAN you would like to upload the IP to DDNS server
  - f. Click Get domain
  - g. Click OK on the pop up notification window

Applications >> Dynamic DNS Setup

Dynamic DNS Setup | Set to Factory Default |

Enable Dynamic DNS Setup View Log Force Update

Auto-Update interval  Min(s) (180~14400)

Accounts:

Index	WAN Interface
1.	WAN1 Only
2.	WAN1 First
3.	WAN1 First
4.	WAN1 First
5.	WAN1 First
6.	WAN1 First

Applications >> Dynamic DNS Setup >> Dynamic DNS Account Setup

Index : 2

Enable Dynamic DNS Account

Service Provider  View Log

Status  View Log

Domain Name  Get domain

Determine Real WAN IP

Determine WAN IP

OK Clear Cancel

192.168.193.10 says:

Note: Router will automatically get the domain name from MyVigor server.  
Please kindly wait for a while, then check the config again.

Prevent this page from creating additional dialogs.

OK

2. Wait few seconds for router to get the domain name, then, we can click the profile to check the information of license and domain name.

Applications >> Dynamic DNS Setup

Dynamic DNS Setup | Set to Factory Default |

Enable Dynamic DNS Setup View Log Force Update

Auto-Update interval  Min(s) (180~14400)

Accounts:

Index	WAN Interface	Domain Name	Active
1.	WAN1 Only	Customized	v
2.	WAN 1/2/3/4	192.168.193.10 draydns.com	v
3.	WAN1 First		x
4.	WAN1 First		
5.	WAN1 First		
6.	WAN1 First		

Applications >> Dynamic DNS Setup >> Dynamic DNS Account Setup

Index : 2

Enable Dynamic DNS Account

Service Provider  View Log

Status  View Log

Domain Name  Edit domain

Determine Real WAN IP

Determine WAN IP

OK Clear Cancel

## Modify Domain Name

Currently, only the domain name is allowed to be modified MyVigor website. We will need to register the router to MyVigor server, and log in to MyVigor website to modify it.

1. Please visit <https://myvigor.draytek.com/> or go to Applications >> Dynamic DNS Setup >> DrayDDNS profile and click Edit domain.

Index : 2

Enable Dynamic DNS Account  
 Service Provider: DrayTek Global (www.drayddns.com) ▾  
 Status: **Activated** [Start Date:2017-02-23 Expire Date:2018-02-23]  
 Domain Name: 192.168.39.44 .drayddns.com Edit domain  
 Determine Real WAN IP: WAN IP ▾  
 Determine WAN IP: WAN 1 ▲, WAN 2, WAN 3, WAN 4 ▾

- Log in to MyVigor Website, choose the profile, then click Edit DDNS settings.

My Information - My Products

Device Information  
 Device Name: Vigor2925  
 Serial Number: 192.168.39.44  
 Model: Vigor2925 Series

Device's Service
Expired License

Service	Provider	Action	Status	Start Date	Expired Date	Note
WCF	BPJM	<input type="button" value="Activate"/>	● On	-	-	-
WCF	Cyren	<input type="button" value="Trial"/>	● On	-	-	-
APPE	DT-APPE	<input type="button" value="Activate"/>	● On	-	-	-
DDNS	DT-DDNS	<input type="button" value="Renew"/>	● On	2017-02-23	2018-02-23	<input type="button" value="Edit DDNS settings"/>

- Input the desired Domain name (e.g., XXXX25) and click Update.

Edit DDNS Settings

Please note that the DrayDDNS service is currently for internal use only.

Domain Name: 192.168.39.44 .drayddns.com

Current IP:

Last Update: 2017/2/24 14:27:20

Status: Update success

Update

- Vigor router will get the modified domain name when the it performs next DDNS updating. We can click Sync domain to accelerate this process.

Index : 2

Enable Dynamic DNS Account  
 Service Provider: DrayTek Global (www.drayddns.com) ▾  
 Status: **Activated** [Start Date:2017-02-23 Expire Date:2018-02-23]  
 Domain Name: [XXXXXXXXXX] .drayddns.com Sync domain  
 WAN Interfaces: WAN IP ▾  
 Determine WAN IP: WAN 1 ▲, WAN 2, WAN 3, WAN 4 ▼

After few seconds, the router will get the new domain name and print it on the profiles list.

Dynamic DNS Setup | [Set to Factory Default](#) |

Enable Dynamic DNS Setup

Auto-Update interval:  Min(s) (180~14400)

Accounts:

Index	WAN Interface	Domain Name	Active
1.	WAN1 Only	Customized	v
2.	WAN 1/2/3/4	<span style="border: 1px solid red; padding: 2px;">XXXXXXXXXX.drayddns.com</span>	v
3.	WAN1 First		x
4.	WAN1 First		x
5.	WAN1 First		x
6.	WAN1 First		x

Dynamic DNS Setup | [Set to Factory Default](#) |

Enable Dynamic DNS Setup

Auto-Update interval:  Min(s) (180~14400)

Accounts:

Index	WAN Interface	Domain Name	Active
1.	WAN1 Only	Customized	v
2.	WAN 1/2/3/4	<span style="border: 1px solid red; padding: 2px;">XXXXXXXXXX25.drayddns.com</span>	v
3.	WAN1 First		x
4.	WAN1 First		x
5.	WAN1 First		x
6.	WAN1 First		x

## A-2 How to Configure Customized DDNS?

This article describes how to configure customized DDNS on Vigor routers to update your IP to the DDNS server. We will take “Changeip.org” and “3322.net” as example. Before setting, please make sure that the WAN connection is up.

### Part A : Changeip.org

Physical Connection			System Uptime: 0day 2:25:59		
IPv4		IPv6			
<b>LAN Status</b>		Primary DNS: 168.95.192.1		Secondary DNS: 168.95.1.1	
IP Address		TX Packets		RX Packets	
10.1.7.1		2069		1036	
<b>WAN 1 Status</b> >> <a href="#">Drop PPPoE</a>					
Enable	Line	Name	Mode	Up Time	
Yes	Ethernet	iwiz	PPPoE	2:25:53	
IP	GW IP	TX Packets	TX Rate(Bps)	RX Packets	RX Rate(Bps)
1.169.185.242	168.95.98.254	14851	9506	11281	912

Note that,

Username: jo\*\*\*

Password: jo\*\*\*\*\*

Host name: j\*\*\*\*.changeip.org

WAN IP address: 1.169.185.242

Following is the screenshot of editing the HTML script on the browser to update your IP to the DDNS server.



```
← → ↻ www.changeip.com/dynamic/dns/update.asp?u=jo...&p=jo...&host...
免費的 Hotmail 建議的網站 Home Page 網頁快訊圖庫 從 IE 匯入 Go

200 Successful Update (Address Used: 1.169.185.242)

Updated target: j...changeip.org
Updated 1 host records
Updated 0 zone serial numbers
Reviewed 1 possible records
Total updates: 75
Lockout counter: 1 out of 60
Lockout reset: 60 mins
Elapsed time: 0.01 seconds
NIC version: 2.68

For XML output add &xml=1
Use SSL for better security.
```

Now we have to configure the router so it can do the same job for us automatically.

3. Please go to Applications >> Dynamic DNS to create a profile for customized DDNS client.

Applications >> Dynamic DNS Setup >> Dynamic DNS Account Setup

**Index : 1**

Enable Dynamic DNS Account

WAN Interface: WAN1 First

Service Provider: User-Defined

Provider Host: changeip.org

Service API: /dynamic/dns/update.asp?  
u=jo\*\*\*\*&p=jo\*\*\*\*\*&hostname=j\*\*\*\*.changeip.org&ip=###IP###&c  
md=update&offline=0

Auth Type: basic

Connection Type: Http

Server Response:

Login Name: chronic6653 (max. 64 characters)

Password: \*\*\*\*\* (max. 23 characters)

Wildcards

Backup MX

Mail Extender:

Determine Real WAN IP: Internet IP

2. Set the Service Provider as User-Defined.
3. Set the Service API as:  
/dynamic/dns/update.asp?u=jo\*\*\*&p=jo\*\*\*\*\*&hostname=j\*\*\*\*.changeip.org&ip=###IP###&cmd=update&offline=0

In which, ###IP### is a value which will be replaced with the current interface IP address automatically when DDNS service is running. In this case the IP will be 1.169.185.242.

4. After setting, the Customized DDNS service will be up, and our IP will be updated to the DDNS server.

Part B : 3322.net

WAN 1	
Link Status	: <span style="color: green;">Connected</span>
MAC Address	: 00-50-7F-C8-C6-A1
Connection	: PPPoE
IP Address	: 111.243.178.53
Default Gateway	: 168.95.98.254
Primary DNS	: 168.95.192.1
Secondary DNS	: 168.95.1.1

Username: bi\*\*\*\*\*

Password: 88\*\*\*\*\*

Host name: bi\*\*\*\*\*.3322.org

WAN IP address: 111.243.178.53

To update the IP to the DDNS server via editing the HTML script, we can Enter the following script on the browser:

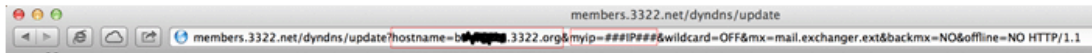

And the result will be :

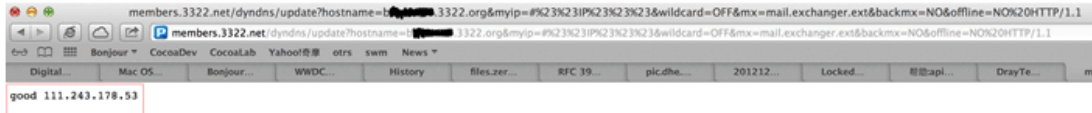

“good 111.243.178.53” means our IP has been updated to the server successfully.

Now we have to configure the router so it can do the same job for us automatically.

1. Please go to Applications >> Dynamic DNS to create a profile for Customized DDNS client.

#### Applications >> Dynamic DNS Setup >> Dynamic DNS Account Setup

##### Index : 1

<input checked="" type="checkbox"/> Enable Dynamic DNS Account	
WAN Interface	WAN1 First
Service Provider	Customized
Provider Host	members.3322.net
Service API	<code>/dyndns/update? hostname=b...3322.org&amp;myip=###IP###&amp;wildcard=OFF&amp;mx=mail .exchanger.ext&amp;backmx=NO&amp;offline=NO</code>
Auth Type	basic
Connection Type	Http
Server Response	
Login Name	chronic6653 (max. 64 characters)
Password	..... (max. 23 characters)
<input type="checkbox"/> Wildcards	
<input type="checkbox"/> Backup MX	
Mail Extender	
Determine Real WAN IP	Internet IP

OK Clear Cancel

4. Set the Service Provider as User-Defined.
5. Set the Provider Host as member.3322.net.
6. Set the Service API as:  
`/dyndns/update?hostname=yourhost.3322.org&myip=###IP###&wildcard=OFF&mx=mail  
.exchanger.ext&backmx=NO&offline=NO`
7. Enter your account and password.
8. After the setting, the Customized DDNS service will be up, and our IP will be updated to the DDNS server automatically.



## Part C : Extend Note

The customized Service Provider is also eligible with the ClouDNS.net.

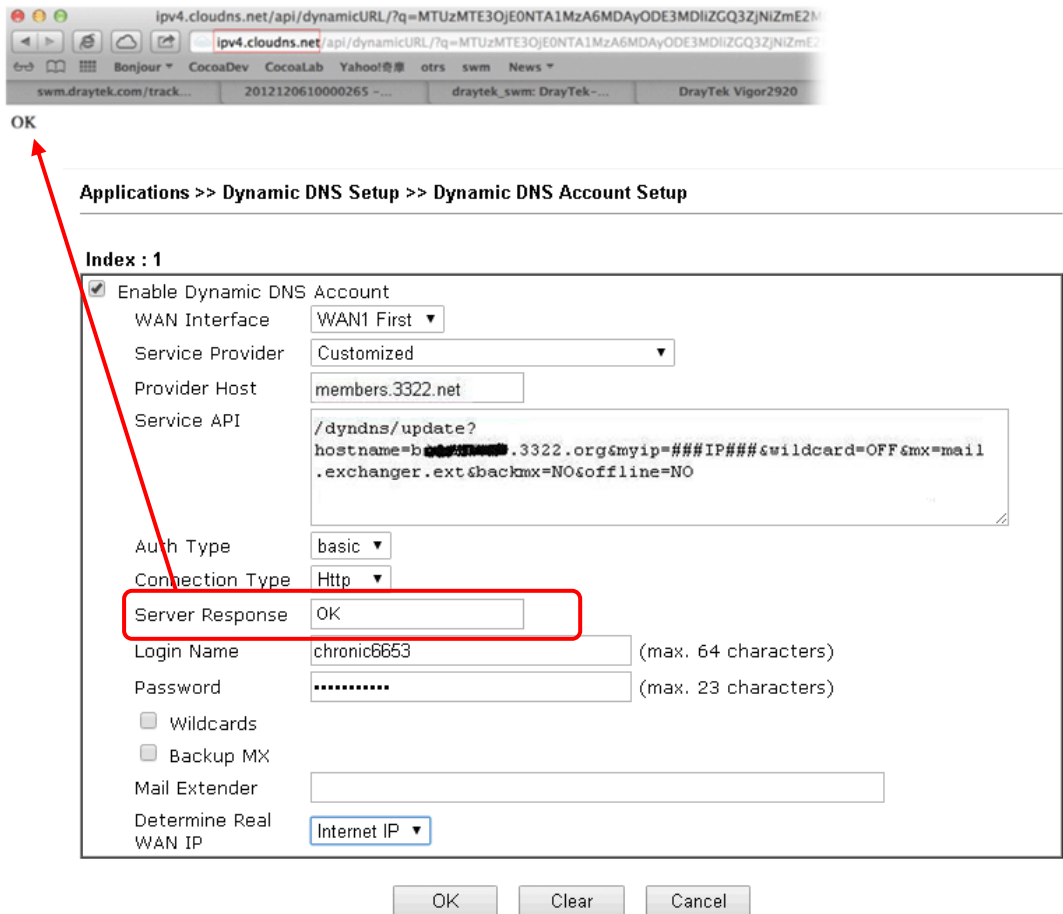

The screenshot shows a web browser window with the URL `ipv4.cloudns.net/api/dynamicURL/?q=MTUzMTE3OjE0NTA1MzA6MDAyODE3MDIiZGQ3ZjNiZmE2M...`. Below the browser, the text "OK" is displayed. A red arrow points from the "OK" text to the "Server Response" field in the "Dynamic DNS Account Setup" form. The form is titled "Applications >> Dynamic DNS Setup >> Dynamic DNS Account Setup" and includes the following fields:

- Enable Dynamic DNS Account
- WAN Interface: WAN1 First
- Service Provider: Customized
- Provider Host: members.3322.net
- Service API: `/dyn dns / update ? hostname = b... .3322.org & myip = ## IP ## & wildcard = OFF & mx = mail . exchanger . ext & backmx = NO & offline = NO`
- Auth Type: basic
- Connection Type: Http
- Server Response: OK (highlighted with a red box)
- Login Name: chronic6653 (max. 64 characters)
- Password: ..... (max. 23 characters)
- Wildcards
- Backup MX
- Mail Extender: (empty field)
- Determine Real WAN IP: Internet IP

At the bottom of the form are three buttons: OK, Clear, and Cancel.

---

## II-6 Routing

Route Policy (also well known as PBR, policy-based routing) is a feature where you may need to get a strategy for routing. The packets will be directed to the specified interface if they match one of the policies. You can setup route policies in various reasons such as load balance, security, routing decision, and etc.

Through protocol, IP address, port number and interface configuration, Route Policy can be used to configure any routing rules to fit actual request. In general, Route Policy can easily reach the following purposes:

### Load Balance

You may manually create policies to balance the traffic across network interface.

### Specify Interface

Through dedicated interface (WAN/LAN/VPN), the data can be sent from the source IP to the destination IP.

### Address Mapping

Allows you specify the outgoing WAN IP address (es) for an internal private IP address or a range of internal private IP addresses.

### Priority

The router will determine which policy will be adopted for transmitting the packet according to the priority of Static Route and Route Policy.

### Failover to/Failback

Packets will be sent through another Interface or follow another Policy when the original interface goes down (Failover to). Once the original interface resumes service (Failback), the packets will be returned to it immediately.

### Other routing

Specify routing policy to determine the direction of the data transmission.



#### Info

For more detailed information about using policy route, refer to Support >>FAQ/Application Note on [www.draytek.com](http://www.draytek.com).

---

# Web User Interface

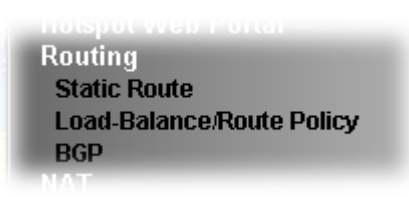

## II-6-1 Static Route

Go to Routing >> Static Route. The router offers IPv4 and IPv6 for you to configure the static route. Both protocols bring different web pages.

### Static Route for IPv4

Routing >> Static Route Setup

IPv4		IPv6		<a href="#">Set to Factory Default</a>	<a href="#">View Routing Table</a>
Index	Enable	Destination Address	Mask	Gateway	Interface
1.	<input type="checkbox"/>				
2.	<input type="checkbox"/>				
3.	<input type="checkbox"/>				
4.	<input type="checkbox"/>				
5.	<input type="checkbox"/>				
6.	<input type="checkbox"/>				
7.	<input type="checkbox"/>				
8.	<input type="checkbox"/>				
9.	<input type="checkbox"/>				
10.	<input type="checkbox"/>				
11.	<input type="checkbox"/>				
37.	<input type="checkbox"/>				
38.	<input type="checkbox"/>				
39.	<input type="checkbox"/>				
40.	<input type="checkbox"/>				

Backup settings: <input type="button" value="Backup"/>	Upload From File: <input type="button" value="選擇檔案"/> 未選擇任何檔案 <input type="button" value="Restore"/>
---	---

Available settings are explained as follows:

Item	Description
Index	The number (1 to 40) under Index allows you to open next page to set up static route.
Enable	Check the box to enable the static route profile.
Destination Address	Displays the destination address of the static route.

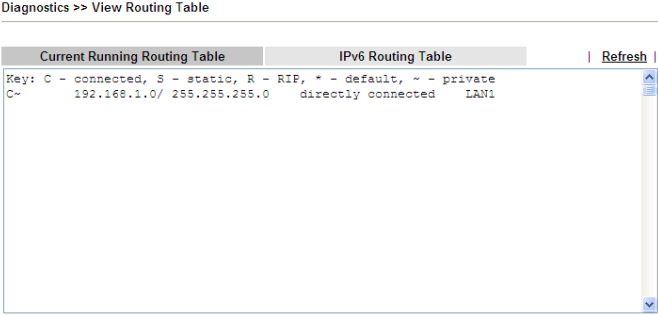
Set to Factory Default	Clear all of the settings and return to factory default settings.
Viewing Routing Table	<p>Displays the routing table for your reference.</p> <p>Diagnostics &gt;&gt; View Routing Table</p> 
Backup	Click it to backup the configuration of static route settings.
Restore	Click it to restore the configuration of static route settings. Before clicking, make sure upload the configuration file onto Vigor router.

### Add Static Routes to Private and Public Networks

Here is an example (based on IPv4) of setting Static Route in Main Router so that user A and B locating in different subnet can talk to each other via the router. Assuming the Internet access has been configured and the router works properly:

- use the Main Router to surf the Internet.
- create a private subnet 192.168.10.0 using an internal Router A (192.168.1.2)
- create a public subnet 211.100.88.0 via an internal Router B (192.168.1.3).
- have set Main Router 192.168.1.1 as the default gateway for the Router A 192.168.1.2.

Before setting Static Route, user A cannot talk to user B for Router A can only forward recognized packets to its default gateway Main Router.

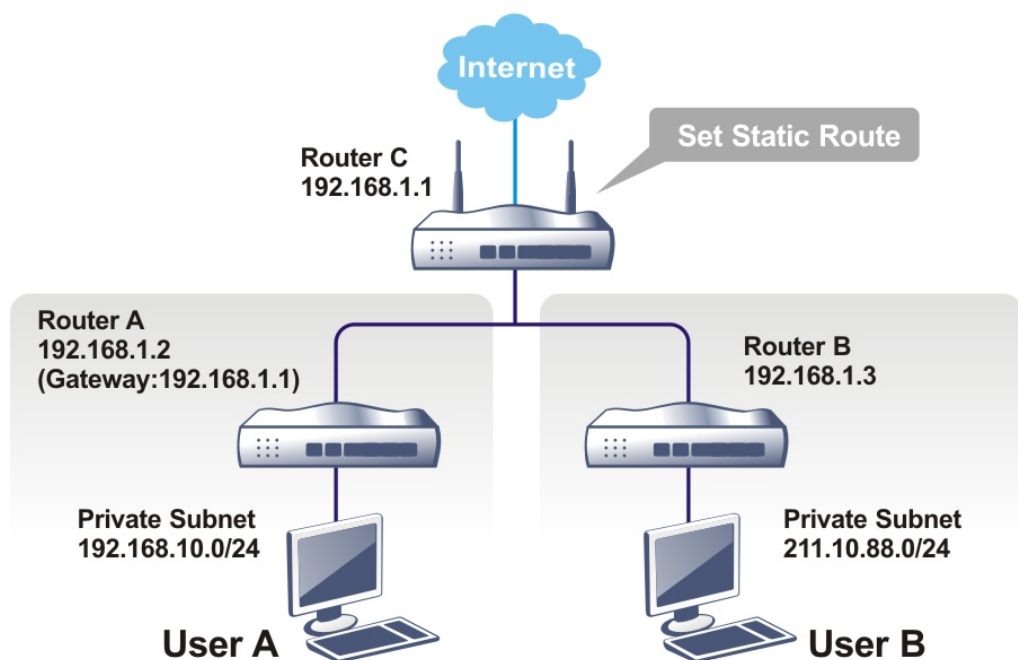

1. Go to LAN page and click General Setup, select 1st Subnet as the RIP Protocol Control. Then click the OK button.



Info

There are two reasons that we have to apply RIP Protocol Control on 1st Subnet. The first is that the LAN interface can exchange RIP packets with the neighboring routers via the 1st subnet (192.168.1.0/24). The second is that those hosts on the internal private subnets (ex. 192.168.10.0/24) can access the Internet via the router, and continuously exchange of IP routing information with different subnets.

- 2. Click the Routing >> Static Route and click on the Index Number 1. Check the Enable box. Please add a static route as shown below, which regulates all packets destined to 192.168.10.0 will be forwarded to 192.168.1.2. Click OK.

Routing >> Static Route Setup

Index No. 1

<input checked="" type="checkbox"/> Enable	
Destination IP Address	192.168.10.0
Subnet Mask	255.255.255.255 / 32
Gateway IP Address	192.168.1.2
Network Interface	LAN1

Note:

WAN7, WAN8, WAN9 are PVCs or VLANs that can be configured on the [Multi-PVC/VLAN](#) page.

OK Cancel Delete

Available settings are explained as follows:

Item	Description
Enable	Click it to enable this profile.
Destination IP Address	Enter an IP address as the destination of such static route.
Subnet Mask	Enter the subnet mask for such static route.
Gateway IP Address	Enter the IP address of the gateway.
Network Interface	Use the drop down list to specify an interface for such static route.

- 3. Return to Static Route Setup page. Click on another Index Number to add another static route as show below, which regulates all packets destined to 211.100.88.0 will be forwarded to 192.168.1.3. Click OK.

Routing >> Static Route Setup

Index No. 2

<input checked="" type="checkbox"/> Enable	
Destination IP Address	211.100.88.0
Subnet Mask	255.255.255.255 / 32
Gateway IP Address	192.168.1.3
Network Interface	LAN1

Note:

WAN7, WAN8, WAN9 are PVCs or VLANs that can be configured on the [Multi-PVC/VLAN](#) page.

OK Cancel Delete

- Go to Diagnostics and choose Routing Table to verify current routing table.

Diagnostics >> View Routing Table

Current Running Routing Table		IPv6 Routing Table		Refresh
Key: C - connected, S - static, R - RIP, * - default, ~ - private				
S~	192.168.10.0/ 255.255.255.0	via 192.168.1.2	LAN1	
C~	192.168.1.0/ 255.255.255.0	directly connected	LAN1	
S~	211.100.88.0/ 255.255.255.0	via 192.168.1.3	LAN1	

### Static Route for IPv6

You can set up to 40 profiles for IPv6 static route. Click the IPv6 tab to open the following page:

Routing >> Static Route Setup

IPv4		IPv6		Set to Factory Default	View IPv6 Routing Table
Index	Enable	Destination Address	Gateway	Interface	
1.	<input type="checkbox"/>				
2.	<input type="checkbox"/>				
3.	<input type="checkbox"/>				
4.	<input type="checkbox"/>				
5.	<input type="checkbox"/>				
6.	<input type="checkbox"/>				
7.	<input type="checkbox"/>				
8.	<input type="checkbox"/>				

Available settings are explained as follows:

Item	Description
Index	The number (1 to 40) under Index allows you to open next page to set up static route.
Enable	Check the box to enable the static route profile.
Destination Address	Displays the destination address of the static route.
Gateway	Displays the IP address of the gateway.
Interface	Displays the interface used for this static route.
Set to Factory Default	Clear all of the settings and return to factory default settings.
Viewing IPv6 Routing Table	Displays the routing table for your reference.
Backup	Click it to backup the configuration of static route settings.
Restore	Click it to restore the configuration of static route settings. Before clicking, make sure upload the configuration file onto Vigor router.

Click any underline of index number to get the following page.

Routing >> Static Route Setup

**Index No. 1**

<input type="checkbox"/> Enable	
Destination IPv6 Address / Prefix Len	<input type="text" value="::"/> / <input type="text" value="0"/>
Gateway IPv6 Address	<input type="text"/>
Network Interface	<input type="text" value="LAN1"/> ▾

Available settings are explained as follows:

Item	Description
Enable	Click it to enable this profile.
Destination IPv6 Address / Prefix Len	Enter the IP address with the prefix length for this entry.
Gateway IPv6 Address	Enter the gateway address for this entry.
Network Interface	Use the drop down list to specify an interface for this static route.

When you finish the configuration, please click OK to save and exit this page.

## II-6-2 Load-Balance /Route Policy

It allows network administrator to manage the outbound traffic more specifically. The policy set in Load-Balance/Route Policy always has higher priority than Default Route and Auto Load Balance set in WAN >> Internet Access, and always has lower priority than the Firewall Rules. Administrator may also define a priority to this policy.

This page lists all the policies and shows whether the policy is enabled/disabled, what are the criteria to match, and through which the interface should the traffic to go if the criteria are matched, and also its priority.

Routing >> Load-Balance/Route Policy



Load-Balance/Route Policy

10 rules per page | [Set to Factory Default](#) | [Diagnose](#) |

Index	Enable	Comment	Protocol	Interface	Priority	Source	Destination	Dest Port	Move Up	Move Down
<a href="#">1</a>	<input type="checkbox"/>		Any	WAN1	200	Any	Any	Any		<a href="#">Down</a>
<a href="#">2</a>	<input type="checkbox"/>		Any	WAN1	200	Any	Any	Any	<a href="#">UP</a>	<a href="#">Down</a>
<a href="#">3</a>	<input type="checkbox"/>		Any	WAN1	200	Any	Any	Any	<a href="#">UP</a>	<a href="#">Down</a>
<a href="#">4</a>	<input type="checkbox"/>		Any	WAN1	200	Any	Any	Any	<a href="#">UP</a>	<a href="#">Down</a>
<a href="#">5</a>	<input type="checkbox"/>		Any	WAN1	200	Any	Any	Any	<a href="#">UP</a>	<a href="#">Down</a>
<a href="#">6</a>	<input type="checkbox"/>		Any	WAN1	200	Any	Any	Any	<a href="#">UP</a>	<a href="#">Down</a>
<a href="#">7</a>	<input type="checkbox"/>		Any	WAN1	200	Any	Any	Any	<a href="#">UP</a>	<a href="#">Down</a>
<a href="#">8</a>	<input type="checkbox"/>		Any	WAN1	200	Any	Any	Any	<a href="#">UP</a>	<a href="#">Down</a>
<a href="#">9</a>	<input type="checkbox"/>		Any	WAN1	200	Any	Any	Any	<a href="#">UP</a>	<a href="#">Down</a>
<a href="#">10</a>	<input type="checkbox"/>		Any	WAN1	200	Any	Any	Any	<a href="#">UP</a>	<a href="#">Down</a>

<< [1-10](#) | [11-20](#) | [21-30](#) | [31-40](#) | [41-50](#) >>

[Next >>](#)

Wizard Mode: most frequently used settings in three pages

Advance Mode: all settings in one page

Note:

The policies in blue are SD-WAN related, and can only be edited via ACS.

OK

Available settings are explained as follows:

Item	Description
Index	Click the number of index to access into the configuration web page.
Enable	Check this box to enable this policy.
Protocol	Display the protocol used for this policy.
Interface	Display the interface to send packets to once the policy is matched.
Priority	Display the priority value for such route policy profile.
Source	Display the content of source IP, subnet, object or group.
Destination	Display the content of destination IP, subnet, object or group.
Dest Port	Display the content of the destination port.
Move UP/Move Down	Use Up or Down link to move the order of the policy.
Wizard Mode	Allow to configure frequently used (simple and basic) settings of route policy via three setting pages.
Advance Mode	Allow to configure detailed settings of route policy.



To use Wizard Mode, simple do the following steps:

1. Click the Wizard Mode radio button.
2. Click Index 1. The setting page will appear as follows:

Routing >> Load-Balance/Route Policy

---

**Index: 1 Criteria**

Load-Balance/Route Policy applies to packets that meet the following criteria

Source IP  Any  
 Src IP Start      Src IP End  
 ~

Destination IP  Any  
 Dest IP Start      Dest IP End  
 ~

Country Object

Available settings are explained as follows:

Item	Description
Source IP	<p>Any - Any IP can be treated as the source IP.</p> <p>Src IP Start - Enter the source IP start for the specified WAN interface.</p> <p>Src IP End - Enter the source IP end for the specified WAN interface. If this field is blank, it means that all the source IPs inside the LAN will be passed through the WAN interface.</p>
Destination IP	<p>Any - Any IP can be treated as the destination IP.</p> <p>Dest IP Start- Enter the destination IP start for the specified WAN interface.</p> <p>Dest IP End - Enter the destination IP end for the specified WAN interface. If this field is blank, it means that all the destination IPs will be passed through the WAN interface.</p> <p>Country Object - Specify a country object. All the IPs coming from the country (countries) specified in the object will be passed through the WAN interface.</p>

3. Click Next to get the following page.

Routing >> Load-Balance/Route Policy

---

**Index: 1 Interface**

Load-Balance/Route Policy directs the packets to the interface below

Interface

Interface Mode

Available settings are explained as follows:

Item	Description
Interface	You can select an interface from one of the following: WAN, LAN, VPN, IP Routed Subnet, and DMZ Subnet. Packets match with the above criteria will be transferred to the interface chosen here. Select an interface from the list.
Interface Mode	Select IP-Based Load Balance or Session-Based Load Balance if WAN is specified as the Interface.

- Specify an interface and click Next. The following page will appear only if you choose WAN1 ~WAN9 as Interface.

Routing >> Load-Balance/Route Policy

Index: 1 NAT or Routing

Based on the settings in the previous pages, we guess you want to have: Force NAT

The current setting is:

Force NAT

Force Routing

Available settings are explained as follows:

Item	Description
Force NAT /Force Routing	It determines which mechanism that the router will use to forward the packet to WAN.

- After choosing the mechanism, click Next to get the summary page for reference.

Routing >> Load-Balance/Route Policy

Index: 1 Configuration Summary

**Criteria**

---

Source IP Any

Destination IP Any

**Interface**

---

WAN1

**More options**

---

Force NAT

- If there is no error, click Finish to complete wizard setting.

To use Advance Mode, do the following steps:

1. Click the Advance Mode radio button.
2. Click Index 1 to access into the following page.

Routing >> Route Policy

Index: 1

Enable

Comment

---

Criteria

Protocol

Source

Destination

Destination Port

Send via if Criteria Matched

---

Interface

Interface Mode

Gateway

Default Gateway

Specific Gateway

Packet Forwarding to WAN/LAN via

Force NAT

Force Routing

Failover to

WAN/LAN

VPN

Route Policy

Gateway

Default Gateway

Specific Gateway

---

**Note:**

Force NAT(Routing): NAT(Routing) will be performed on outgoing packets, regardless of which type of subnet (NAT or IP Routing) they originate from.

Available settings are explained as follows:

Item	Description
Enable	Check this box to enable this policy.
Comment	Type a brief explanation for such profile.
Criteria	<p>Router examines outgoing LAN traffic to find the first rule whose criteria are satisfied.</p> <p>Protocol - Use the drop-down menu to choose a proper protocol for the WAN interface.</p> <p>Source - Source IP addresses to which this rule is to be applied.</p> <ul style="list-style-type: none"> <li>● Any - This rule applies to all source IP addresses.</li> <li>● IP Range - This rule applies to the specified range of source IP addresses.</li> </ul> <p>- Start - Enter an address as the starting IP for</p>

	<p>such profile.</p> <ul style="list-style-type: none"> <li>- End - Enter an address as the ending IP for such profile.</li> </ul> <ul style="list-style-type: none"> <li>● IP Subnet - This rule applies to source IP addresses defined by the specified network IP address and subnet mask. <ul style="list-style-type: none"> <li>- Network - Enter an IP address here.</li> <li>- Mask - Use the drop down list to choose a suitable mask for the network.</li> </ul> </li> <li>● IP Object / IP Group - Use the drop down list to choose a preconfigured IP object/group.</li> </ul> <p>Destination - Destination IP addresses to which this rule is to be applied.</p> <ul style="list-style-type: none"> <li>● Any - This rule applies to all source IP addresses.</li> <li>● IP Range - This rule applies to the specified range of destination IP addresses. <ul style="list-style-type: none"> <li>- Start - Enter an address as the starting IP for such profile.</li> <li>- End - Enter an address as the ending IP for such profile.</li> </ul> </li> <li>● IP Subnet - This rule applies to destination IP addresses defined by the specified network IP address and subnet mask. <ul style="list-style-type: none"> <li>- Network - Enter an IP address here.</li> <li>- Mask - Use the drop down list to choose a suitable mask for the network.</li> </ul> </li> <li>● Domain Name - Specify a domain name as the destination. <ul style="list-style-type: none"> <li>- Select - Click it to choose an existing domain name defined in Objects Setting&gt;&gt;String Object.</li> <li>- Delete - Remove current used domain name.</li> <li>- Add - Create a new domain name as the destination.</li> </ul> </li> <li>● IP Object / IP Group - Use the drop down list to choose a preconfigured IP object/group.</li> <li>● Country Object - Use the drop down list to choose a preconfigured object. Then all IPs within that country will be treated as the destination IP.</li> </ul> <p>Destination Port - Destination port numbers to which this rule is to be applied. As only TCP and UDP protocols use port numbers, this setting does not apply to the ICMP protocol.</p> <ul style="list-style-type: none"> <li>● Any - This rule applies to all destination ports.</li> <li>● Dest Port Range - This rule applies to the specified range of destination ports. <ul style="list-style-type: none"> <li>- Start - Enter the destination port start for the destination IP.</li> <li>- End - Enter the destination port end for the destination IP. If this field is blank, it means that all the destination ports will be passed through the WAN interface.</li> </ul> </li> </ul>
Send to if criteria matched	<p>If criteria are matched, the traffic will be sent to the designated interface and gateway.</p> <p>Interface - Packets match with the above criteria will be</p>

---

transferred to the interface chosen here. Select an interface from the list (WAN/LAN: A WAN or LAN interface; VPN: A Virtual Private Network; PVC).

Interface Mode - It is available if WAN is selected as the Interface.

- IP Based Load Balance - The same source / destination IP pair will select the same WAN interface as policy. It is the default setting.
- Session Based Load Balance - All of the WAN interfaces will be used (as out-going WAN) for passing through new sessions to get better transmission speed. Though good speed test result for throughput might be reached; however, some web site may not open smoothly, especially the site need authentication, e.g., FTP.

If you have no strong demand about speed test result, keep default settings as IP based.

Gateway - Select a gateway.

- Default Gateway - Traffic will be sent to the default gateway address of the specified interface.
- Specific Gateway - Traffic will be sent to the specified gateway address instead of the default gateway address.

Packet Forwarding to WAN/LAN via - When you choose LAN/WAN (e.g., WAN1) as the Interface for packet transmission, you have to specify the way the packet forwarded to.

- Force NAT - The source IP address will not be used to connect to the remote destination. Network Address Translation (NAT) will be used, where a common IP address will be used.
- Force Routing - The source IP address will be preserved when connecting to the remote destination.

Failover to - If the interface specified above loses connection, traffic can be forwarded to an alternate interface or be scrutinized by an alternate route policy.

- WAN/LAN - Use the drop down list to choose an interface as an auto failover interface.
- VPN - Use the drop down list to choose a VPN tunnel as a failover tunnel.
- Route Policy - Use the drop down list to choose an existed route policy profile.
- Gateway - The failed-over traffic can be sent to the Default Gateway of the alternate interface/route policy, or a Specific Gateway at the specified IP address.

Failback- When Failover to option is enabled, Administrator could also enable Failback to clear the existing session on Failover interface and return to the original interface immediately once the original interface resume its service. When Failback is not enabled, the router will only stop sending packets via the Failover interface when the existing sessions are cleared, and this might take a long time because some application will keep

---

	sending packet once a while. Therefore, Failback option is recommended if Administrator wants the traffic to go via the primary interface as soon as possible.
Priority	Specifies the priority of the rule in relation to other rules. Lowering the priority value increases the priority of the rule, and vice versa. Routes in the routing table have a priority value of 150, whereas the default routes have a priority value of 250.  The default priority value of Load Balance/Route Policy rules is 200. To change the priority, move the slider or enter a value.

- When you finish the configuration, please click OK to save and exit this page.

### Diagnose for Route Policy

The button of Diagnose located below the Load-Balance /Route Policy profile is used to trace possible path of the packets sent out of the router.

Packet Forwarding to WAN/LAN via

Failover to

Force NAT  
 Force Routing

WAN/LAN   
 VPN   
 Route Policy

Gateway  Default Gateway  
 Specific Gateway

Priority

OK Clear Cancel Diagnose

Click Diagnose.

### Analyze a single packet

Select this mode to make Vigor router analyze how a single packet will be sent by a route policy.

Diagnostics >> Route Policy Diagnosis

Test how the packets will be routed

Mode  Analyze a single packet  
 Analyze multiple packets by uploading an input file

Packet Information

Protocol   
Src IP  192.168.1.2  
Dst IP  8.8.8.8  
Dst Port

Analyze

Available settings are explained as follows:

Item	Description
Packet Information	Specify the nature of the packets to be analyzed by Vigor router. Protocol - Specify a protocol for diagnosis.

Src IP - IP address of host where the traffic originates.

- Specify an IP - One source IP address.
- Any IP - Source IP address is not specified. Any IP from LAN 1/LAN 2/LAN 3/LAN 4/LAN 5/LAN 6/LAN7/LAN8/DMZ/IP Routed Subnet.
- Subnet/IP Routed Subnet - Any source IP address on the specified subnet.

Dst IP - IP address of the destination host.

- Specify an IP - One destination IP address.
- Any IP - Destination IP address is not specified.

Dst Port - Number of port to which the traffic is sent. This setting is only applicable to UDP and TCP protocols. Use the drop down list to specify the destination port.

Analyze - Click to analyze and display routes, route policies and load balance rules with matching criteria. If required, click export analysis to export the result as a file.

The following shows an analysis example. The packet matched the criteria of one route policy.

Diagnostics >> Route Policy Diagnosis ?

---

Test how the packets will be routed

Mode  Analyze a single packet  
 Analyze multiple packets by uploading an input file

Packet Information

Protocol

Src IP

Dst IP

Dst Port

Analysis

the packet → LAN  Vigor2927

The packet was dropped because the matched policy "policy\_1" failed to failover

Matched Route

Matched	Priority
N/A	N/A

Matched Policy

Matched	Priority	failovered
Route Policy 1	200	Yes

Analyze multiple packets by uploading an input file



Test how the packets will be routed

- Mode  Analyze a single packet  
 Analyze multiple packets by uploading an input file

Input File

未選擇任何檔案

( [download](#) an example input file)

Available settings are explained as follows:

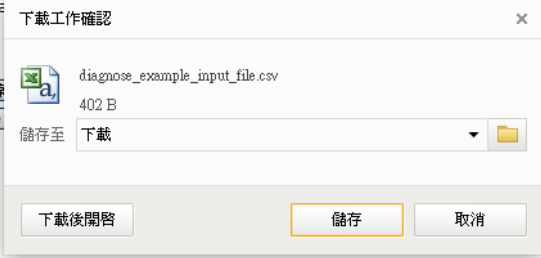
Item	Description
Input File	<p><b>Browse</b> - Click to browse folder structure and select an input file.</p> <p><b>Download and example input file</b> - Click to download a sample input file (blank “.csv” file). Then, click the Browse button to select that blank “.csv” file for saving the result of analysis.</p> <p><b>Mode</b></p> <p><input type="radio"/> analyze how a packet will be sent  <input checked="" type="radio"/> analyze multiple packets by uploading an input file</p> <p><b>Input File</b></p> <p><input type="button" value="選擇檔案"/> <input type="button" value="Analyze"/></p>  <p><b>Analyze</b> -After selecting input file, click to start the analysis process. Click the export button to export the result as a file.</p> <p>Note that the analysis was based on the current "load-balance/route policy" settings, we do not guarantee it will be 100% the same as the real case.</p>

The following shows the analysis of the sample input file. The matched routes and policies are highlighted in green. The Final Result column shows the outcome.





**Mode**

- analyze how a packet will be sent
- analyze how multiple packets as specified in the input file will be sent

**Input File**

未選擇檔案

( [download](#) an example input file)

**Analysis**

Profile	Input Packet Information				Matched Route		Matched Policy			Final Result	
	Proto	Src IP	Dst IP	Dst Port	Route	Priority	Policy	Priority	failovered	Interface	Reason
LA-branch	ICMP	192.168.1.10	10.10.10.10	N/A	No Match	N/A	No Match	N/A	N/A	N/A	The packet was dropped because neither "route" or "policy" was matched
NY-branch	TCP	192.168.1.20	20.20.20.20	5060	No Match	N/A	No Match	N/A	N/A	N/A	The packet was dropped because neither "route" or "policy" was matched
					No Match						The packet was dropped because

## II-6-3 BGP

Border Gateway Protocol (BGP) is a standardized protocol designed to exchange routing and reachability information among autonomous systems (AS) on the Internet.

### II-6-3-1 Basic Settings

Set general settings for for local router and neighboring routers.

Routing >> BGP ?

---

**Basic Settings**
**Static Network**
| [Refresh](#) | [View Routing Table](#) |

**Local**

Enable BGP

Local AS Number  (1~4294967295)

Hold Time  (10~65535 Sec)

Connect Retry Time  (3~255 Sec)

Router ID  (e.g. 1.2.3.4)

**Neighbor**

Index	Enable	AS Number	Profile Name	IP Address	MD5 Auth	Status
1	<input type="checkbox"/>					None
2	<input type="checkbox"/>					None
3	<input type="checkbox"/>					None
4	<input type="checkbox"/>					None
5	<input type="checkbox"/>					None
6	<input type="checkbox"/>					None
7	<input type="checkbox"/>					None
8	<input type="checkbox"/>					None
9	<input type="checkbox"/>					None
10	<input type="checkbox"/>					None

Available settings are explained as follows:

Item	Description
<b>Local</b>	
Enable BGP	Check the box to enable basic BGP function for local router.
Local AS Number	Set the AS number for local router.
Hold Time	Set the time interval (in seconds) to determine the peer is dead when the router is unable to receive any keepalive message from the peer within the time.
Connect Retry Time	If the router fails to connect to neighboring router, it requires a period of time to reconnect. Set the time interval to do reconnection.
Router ID	Specify the LAN subnet for the router.
<b>Neighbor</b>	
Index	Click the index number link to configure neighbor profile.
Enable	Check the box to enable the basic BGP function for neighboring router.
AS Number	Display the AS Number for neighboring router.
Profile Name	Display the name of the neighboring profile.

IP Address	Display the IP address specified for the neighboring profile.
MD5 Auth	Display the status (enabled or disabled) of MD5 authentication.
Status	Display the connection status for local router and neighboring router.

### II-6-3-2 Static Network

This page allows you to configure up to eight neighboring routers for exchanging the routing information with the local router.

Routing >> BGP



Basic Settings		Static Network		<a href="#">View Routing Table</a>
Select	Index	IP Address	Subnet Mask	
<input type="checkbox"/>	1	<input type="text"/>	255.255.255.254 / 31 ▼	
<input type="checkbox"/>	2	<input type="text"/>	255.255.255.254 / 31 ▼	
<input type="checkbox"/>	3	<input type="text"/>	255.255.255.254 / 31 ▼	
<input type="checkbox"/>	4	<input type="text"/>	255.255.255.254 / 31 ▼	
<input type="checkbox"/>	5	<input type="text"/>	255.255.255.254 / 31 ▼	
<input type="checkbox"/>	6	<input type="text"/>	255.255.255.254 / 31 ▼	
<input type="checkbox"/>	7	<input type="text"/>	255.255.255.254 / 31 ▼	
<input type="checkbox"/>	8	<input type="text"/>	255.255.255.254 / 31 ▼	
<input type="checkbox"/>	9	<input type="text"/>	255.255.255.254 / 31 ▼	
<input type="checkbox"/>	10	<input type="text"/>	255.255.255.254 / 31 ▼	
<input type="checkbox"/>	11	<input type="text"/>	255.255.255.254 / 31 ▼	
<input type="checkbox"/>	12	<input type="text"/>	255.255.255.254 / 31 ▼	
<input type="checkbox"/>	13	<input type="text"/>	255.255.255.254 / 31 ▼	

Available settings are explained as follows:

Item	Description
Select	Check the box to enable the configuration for the selected index entry.
IP Address	Enter the IP address for a router.
Subnet Mask	Use the drop down list to specify a subnet mask for the IP address.

---

## Application Notes

### A-1 How to set up Address Mapping with Route Policy?

Address Mapping is used to map a specified private IP or a range of private IPs of NAT subnet into a specified WAN IP (or WAN IP alias IP). Refer to the following figure.

This document introduces how to set up address mapping with Route Policy. When a WAN interface has multiple public IP addresses, Administrator may specify the outgoing IP for certain internal IP address by a Route Policy.

1. Set up WAN IP Alias. Go to WAN >> Internet Access >> Details Page, and click on WAN IP Alias button.

Index	Enable	Aux. WAN IP
1.	<input type="checkbox"/>	---
2.	<input checked="" type="checkbox"/>	172.17.1.1
3.	<input checked="" type="checkbox"/>	172.17.2.2
4.	<input type="checkbox"/>	0.0.0.0
5.	<input type="checkbox"/>	0.0.0.0
6.	<input type="checkbox"/>	0.0.0.0
7.	<input type="checkbox"/>	0.0.0.0
8.	<input type="checkbox"/>	0.0.0.0

<< 1-8 | 9-16 | 17-24 | 25-32 >> Next >>

- Check Enable.
- Enter the WAN IP address.
- Click OK to save.

After setting up the WAN IP Alias, the IP addresses will be shown in the drop-down list of Interface in Route Policy setting.

- Go to Routing>> Load Balance/Route policy. Create a Route Policy for specific IP address to send from specific WAN IP Address.

Routing >> Load-Balance/Route Policy

Index: 1

Enable

Comment:

---

Criteria

Protocol:

Source:  Start:  End:

Destination:

Destination Port:

Send via if Criteria Matched

---

Interface:  WAN/LAN  VPN

WAN/LAN:  VPN:

Gateway:  Default Gateway  Specific Gateway

Packet Forwarding to WAN/LAN via:  Force NAT  Force Routing

Failover to:  Failover to

Failover to:  WAN/LAN  VPN  Route Policy

WAN/LAN:  VPN:  Route Policy:

Gateway:  Default Gateway  Specific Gateway

---

Priority:

Note:

Force NAT(Routing): NAT(Routing) will be performed on outgoing packets, regardless of which type of subnet (NAT or IP Routing) they originate from.

- Enable this policy.
  - Enter Source IP as the range of private IP address.
  - Leave the Destination IP and Port as Any.
  - Select Interface as WAN, and then select Interface address from the drop-down list. (The List can be edited in WAN IP Alias setting.)
  - Enable Failover to other WAN so the traffic will be sent via other Interface when the path fails. But do not enable this option if you want the traffic only to use a designated IP address.
  - Click OK to save.
- After the above configuration, packet source from the range between 192.168.1.20 and 192.168.1.30 sent to the Internet will use the public IP 172.17.1.1.

## A-2 How to use destination domain name in a route policy?

Route Policy supports using a domain name as destination criteria. It provides a more direct way to set up route policies if the network administrator is trying to specify the gateway for the traffic that destined for a certain website.

To use a destination domain name as criteria, just select Domain Name as Destination in Criteria, and enter the domain name in the empty field.

The screenshot shows the 'Criteria' section of a route policy configuration. The 'Protocol' is set to 'Any', 'Source' is 'IP Range' with start '192.168.1.20' and end '192.168.1.30'. The 'Destination' is set to 'Domain Name' with a text input field containing 'server1.draytek.com'. There are 'Select' and 'Delete' buttons next to the input field, and an 'Add' button below it. The 'Destination Port' is set to 'Any'.

Or you may click Select, and use a string that is pre-defined in Objects Settings >> String Object as the domain name.

The screenshot shows a 'String Object' dialog box overlaid on the configuration interface. The dialog has a title bar 'String Object - Google Chrome' and a URL '192.168.1.1/doc/strobjslt.htm'. It contains a table with the following data:

Index	String
<input type="radio"/>	1 Floor_1
<input type="radio"/>	2 Floor_2
<input type="radio"/>	3 Floor_3
<input type="radio"/>	4 Draytek Hotspot
<input type="radio"/>	5 portal.draytek.com

At the bottom of the dialog are 'OK' and 'Cancel' buttons. In the background, the 'Route Policy' configuration is visible, with the 'Select' button next to the domain name input field highlighted with a red box.

Click Add to add more domain names, we can set up to 5 domain names in one route policy.

The screenshot shows the 'Criteria' section of a route policy configuration. The 'Destination' is set to 'Domain Name'. Below this, there is a list of three domain names: '1 - Floor\_1', '2 - Floor\_2', and '3 - Floor\_3'. Each entry has 'Select' and 'Delete' buttons. There is an 'Add(up to 5)' button below the list. The 'Destination Port' is set to 'Any'.

## Auto-create String Objects

If you manually enter the domain name in a route policy, after clicking OK to apply the route policy, those domain names will be given a number.

**Criteria**

---

Protocol    
Source    
Destination    
 -     
  
Destination Port    
**Send via if Criteria Matched**

---

That means the router has automatically created string objects for those domain names, so that they can be used in other route policies or other functions.

Objects Setting >> String Object

10  strings per page | [Set to Factory Default](#) |

Index	String	<input type="button" value="Clear"/>
1	Floor_1	<input type="checkbox"/>
2	Floor_2	<input type="checkbox"/>
3	Floor_3	<input type="checkbox"/>
4	Draytek Hotspot	<input type="checkbox"/>
5	portal.draytek.com	<input type="checkbox"/>
6	server2.draytek.com	<input type="checkbox"/>

### A-3 Introduction to Load Balance/Route Policy

This document introduces the Load-Balance/Route Policy. This feature allows network administrator to manage the outbound traffic more specifically.

The Policy set in Load-Balance/Route Policy always has higher priority than Default Route and Auto Load Balance set in WAN >> General Setup, and always has lower priority than the Firewall Rules. Administrator may also define a priority to this policy.

To configure Route Policy, go to Routing>>Load-Balance/Route Policy. The following image is a screen-shot of Load-Balance/Route policy page. It lists all the policies and shows whether the policy is enabled, what are the criteria to match, and through which the interface should the traffic to go if the criteria are matched, and also its priority.

Routing >> Load-Balance/Route Policy ?

---

Load-Balance/Route Policy 10 rules per page | [Set to Factory Default](#) | [Diagnose](#) |

Index	Enable	Comment	Protocol	Interface	Priority	Source	Destination	Dest Port	Move Up	Move Down
1	<input checked="" type="checkbox"/>		Any	WAN1	200	Any	Domain Name	Any		<a href="#">Down</a>
2	<input type="checkbox"/>		Any	WAN1	200	Any	Any	Any	<a href="#">UP</a>	<a href="#">Down</a>
3	<input type="checkbox"/>		Any	WAN1	200	Any	Any	Any	<a href="#">UP</a>	<a href="#">Down</a>
4	<input type="checkbox"/>		Any	WAN1	200	Any	Any	Any	<a href="#">UP</a>	<a href="#">Down</a>
5	<input type="checkbox"/>		Any	WAN1	200	Any	Any	Any	<a href="#">UP</a>	<a href="#">Down</a>
6	<input type="checkbox"/>		Any	WAN1	200	Any	Any	Any	<a href="#">UP</a>	<a href="#">Down</a>
7	<input type="checkbox"/>		Any	WAN1	200	Any	Any	Any	<a href="#">UP</a>	<a href="#">Down</a>
8	<input type="checkbox"/>		Any	WAN1	200	Any	Any	Any	<a href="#">UP</a>	<a href="#">Down</a>
9	<input type="checkbox"/>		Any	WAN1	200	Any	Any	Any	<a href="#">UP</a>	<a href="#">Down</a>
10	<input type="checkbox"/>		Any	WAN1	200	Any	Any	Any	<a href="#">UP</a>	<a href="#">Down</a>

<< [1-10](#) | [11-20](#) | [21-30](#) | [31-40](#) | [41-50](#) >> [Next](#) >>

Wizard Mode: most frequently used settings in three pages  
 Advance Mode: all settings in one page

**Note:**  
The policies in blue are SD-WAN related, and can only be edited via ACS.

To set up a Route Policy, just click on an Index number. At the bottom of the page, there are two configuration modes could be choose: the Wizard Mode provides a simple and basic configuration; while Advance Mode allows more options.

1. First, set the criteria of the packets to apply this policy.

Routing >> Load-Balance/Route Policy

---

Index: 3

Enable

Comment

Criteria

Protocol

Source  Start:  End:

Destination  Start:  End:

Destination Port

Send via if Criteria Matched

- a. Select a Protocol.
- b. Enter the Source IP address range, the Source IP could be a single address if the Start and End are the same.
- c. Enter the Destination IP address range.



d. Select the Destination Port.

The above configuration is an example that if a packet is sent from 192.168.1.10-192.168.1.100 to 8.8.8.8, no matter what the protocol or destination port is, it will follow this route policy.

2. Next, we select an interface and gateway through which should the packet be sent if it matches the criteria.

**Send via if Criteria Matched**

---

Interface  WAN/LAN  VPN

Gateway  Default Gateway  Specific Gateway

Packet Forwarding to WAN/LAN via  Force NAT  Force Routing

LAN1  
VPN 1.???

192.168.2.2

a. Select an Interface.

b. Select a Gateway IP. Note that if Interface is chosen to be a LAN, it is necessary to designate a specific gateway.

The above configuration is an example that if a packet matches the criteria of this Route Policy, it will be sent to the default gateway then the destination through VPN1.

3. In Advance Mode, if the Interface is selected as WAN or VPN, there are some more options:

**Send via if Criteria Matched**

---

Interface  WAN/LAN  VPN

Gateway  Default Gateway  Specific Gateway

Packet Forwarding to WAN/LAN via  Force NAT  Force Routing

---

**Priority**

Priority:

Low High

250 150 0

Default Route Routes in Routing Table

OK Clear Cancel Diagnose

- Priority: Administrator may set priority between 1 and 249 for this Route policy, where smaller number indicates higher priority. When two policies are having the same priority, the first (according to the policy index order) matched policy will be implemented.

---

## II-7 LTE

LTE WAN with SIM card can provide convenient Internet access for Vigor router. However, we can't stop thinking about what can Vigor router utilize this SIM card to provide more useful functions for user? Now, we have developed some useful functions for user, such as sending SMS from a router to report router status, rebooting router remotely via SMS with taking security into consideration, and so on.

This section can guide you to use the SIM card in LTE WAN to perform SMS related operations.



Info

This function is used for “L” models only.

---

### Service Network

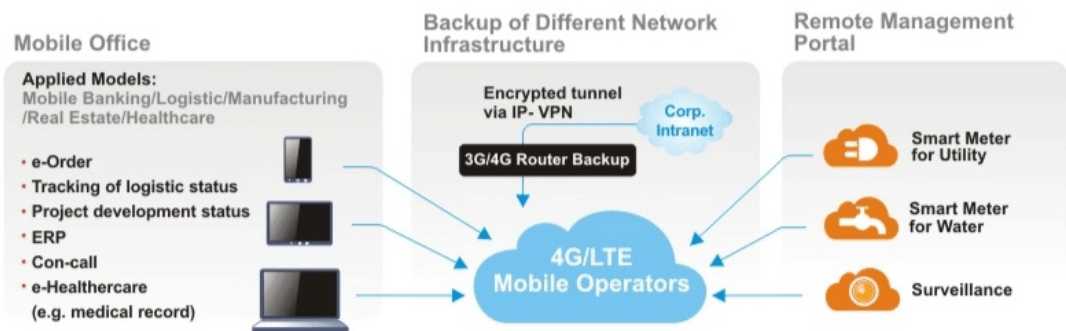

# Web User Interface

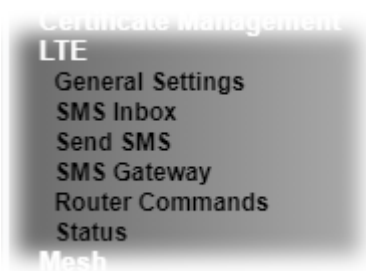

## II-7-1 General Settings

This page allows you to configure general settings for LTE. When SMS Quota Limit is enabled, you can specify the number of SMS quota, actions to perform when quota exceeded, and the period of resetting SMS quota used.

### II-7-1-1 SMS Quota

LTE >> General Settings

**SMS Quota**
**SMS Inbox/Outbox Policy**

Enable SMS Quota Limit  
**Criterion and Action**

---

Quota Limit:  SMS (Current number of SMS sent: 0)

When quota exceeded :  Stop sending SMS function  
 Send Mail Alert to Administrator

Monthly
Custom

Select the day of a month when your (cellular) data resets.  
SMS quota resets on day  at

**Note:**

1. Please make sure the **Time and Date** of the router is configured.
2. When quota exceeded, user can choose to stop sending sms or send **e-mail** to administrator.
3. After clicking OK, the counter used will be reset.

Available settings are explained as follows:

Item	Description
Enable SMS Quota Limit	Check the box to enable such feature.
Quota Limit	Specify the maximum number of sending SMS for LTE.
When quota exceeded	<p>There are two actions to be performed when the quota limit is expired.</p> <p>Stop sending SMS - If it is checked, no SMS for LTE will be sent after the quota limit is expired.</p> <p>Send Mail Alert to Administrator - If it is checked, a mail alert will be sent to the administrator when the quota limit is expired.</p>
Monthly	This setting is to offer a mechanism of resetting the number

	<p>of SMS sent record every month.</p> <p>SMS quota resets on day XX at XX ... -You can determine the starting day in one month. The number of SMS sent will be reset.</p>
Custom	<p>This setting allows the user to define the billing cycle according to his request.</p> <p>The number of SMS sent will be reset with an interval of cycle duration.</p> <p>Custom - Monthly is default setting. If long period or a short period is required, use Custom. The period of reset is between 1 day and 60 days. You can determine the cycle duration by specifying the days and the hours.</p> <ul style="list-style-type: none"> <li>● Cycle duration: Specify the days to reset the number of SMS sent. For example, 7 means the whole cycle is 7 days; 20 means the whole cycle is 20 days. When the time is up, the router will reset the number of SMS sent automatically.</li> <li>● Today is day XX in the cycle -Specify the day in the cycle duration as the starting point which Vigor router will reset the number of SMS sent. For example, 3 means the third day of the duration cycle.</li> </ul>

## II-7-1-2 SMS Inbox/Outbox

Such page allows you to determine which policy shall be used for SMS inbox/outbox.

LTE >> General Settings

SMS Quota	SMS Inbox/Outbox Policy
<p><b>SMS Inbox Policy</b></p> <hr/> <p><input type="checkbox"/> If SMS inbox is full, send e-mail alert to Administrator</p> <p><input type="checkbox"/> If SMS inbox is full, delete the oldest read SMS</p> <p><input type="checkbox"/> Forward new SMS with e-mail to Administrator</p> <p><b>SMS Outbox Policy</b></p> <hr/> <p><input type="checkbox"/> Store SMS outbox cache in USB disk</p>	

OK Cancel

## II-7-2 SMS Inbox

This page will list the received SMS messages in the LTE SIM card. The SMS Inbox table shows the received date, the phone number or sender ID where this message was from, and the beginning of the message content.

Since the data size of one SMS is limited, a long message will be sent by multiple SMS. For the convenience of users, we provide two modes. **Simple Mode** lists SMS messages in order for received time. **Advanced Mode** lists SMS in order for real index in the SIM card. Different SIM cards have different capacities. In general, it's around 30 to 40 SMS. Please note that the SIM card can not receive new SMS when all SMS indexes are occupied.

Click the Simple Mode link or the Advanced Mode link below to switch between these two modes.

### II-7-2-1 Simple Mode

LTE >> SMS Inbox

LTE SMS Inbox

Details	Mark as Read	Delete	Date	From	Message
<a href="#">View</a>	<input type="checkbox"/>	<input type="checkbox"/>	2021/08/20 18:51:54	988	
<a href="#">View</a>	<input type="checkbox"/>	<input type="checkbox"/>	2021/08/08 10:40:21	0906180674	
<a href="#">View</a>	<input type="checkbox"/>	<input type="checkbox"/>	2020/10/21 11:30:55	0982174999	
<a href="#">View</a>	<input type="checkbox"/>	<input type="checkbox"/>	2020/10/19 12:04:04	777	
<a href="#">View</a>	<input type="checkbox"/>	<input type="checkbox"/>	2020/10/15 10:30:35	0982174999	
<a href="#">View</a>	<input type="checkbox"/>	<input type="checkbox"/>	2020/10/15 10:22:29	0965219549	
<a href="#">View</a>	<input type="checkbox"/>	<input type="checkbox"/>	2020/10/08 11:23:25	0906180674	
<a href="#">View</a>	<input type="checkbox"/>	<input type="checkbox"/>	2020/10/08 09:28:06	0972218658	2020/10/08 09:28
<a href="#">View</a>	<input type="checkbox"/>	<input type="checkbox"/>	2020/10/07 07:57:27	923	
<a href="#">View</a>	<input type="checkbox"/>	<input type="checkbox"/>	2020/09/21 18:33:28	988	
<a href="#">View</a>	<input type="checkbox"/>	<input type="checkbox"/>	2020/09/21 13:45:04	988	
<a href="#">View</a>	<input type="checkbox"/>	<input type="checkbox"/>	2020/09/08 11:23:31	0906180674	
<a href="#">View</a>	<input type="checkbox"/>	<input type="checkbox"/>	2020/08/20 15:42:04	988	
<a href="#">View</a>	<input type="checkbox"/>	<input type="checkbox"/>	2020/08/20 11:47:41	0907914272	2020/08/20 11:47
<a href="#">View</a>	<input type="checkbox"/>	<input type="checkbox"/>	2020/08/17 13:28:41	0963954022	2020/08/17 13:28
<a href="#">View</a>	<input type="checkbox"/>	<input type="checkbox"/>	2020/08/14 09:55:46	0982347365	
<a href="#">View</a>	<input type="checkbox"/>	<input type="checkbox"/>	2020/08/08 11:00:02	0906180674	
<a href="#">View</a>	<input type="checkbox"/>	<input type="checkbox"/>	2020/07/31 10:58:27	0961238382	
<a href="#">View</a>	<input type="checkbox"/>	<input type="checkbox"/>	2020/07/22 14:08:35	988	
<a href="#">View</a>	<input type="checkbox"/>	<input type="checkbox"/>	2020/07/08 11:18:45	0906180674	

[Next >>](#)

Simple Mode: Show SMS messages in order of received dates.

**Advanced Mode:** Show SMS in order of indexes in SIM card.

OK

Available settings are explained as follows:

Item	Description
Mark as Read	Those messages in "unread" state are showed in bold text. If you want to change messages into "read" state, select them and click the OK button. Checking the checkbox in title will select all "unread" messages in this page.

Delete	If you want to delete messages, select them and click the OK button. Checking the checkbox in title will select all messages in this page.
Details	<p>If you want to read the full content of the message, click the <a href="#">View</a> link of that message to open the following page. It will change the message into "read" state.</p>  <ul style="list-style-type: none"> <li>● Message Content - Display the full content of the message.</li> <li>● OK - Return to previous page.</li> <li>● Delete - Click it to delete this message and return to previous page.</li> <li>● Next - Click it to see the content of next message.</li> </ul>

### II-7-2-1 Advanced Mode

LTE >> SMS Inbox

LTE SMS Inbox

Index	Mark as Read	Delete	Date	From	Message
<b>1.</b>	<input type="checkbox"/>	<input type="checkbox"/>	2020/08/08 11:00:02	0906180674	[Message Content]
<b>2.</b>	<input type="checkbox"/>	<input type="checkbox"/>	2020/08/08 11:00:02	0906180674	[Message Content]
<b>3.</b>	<input type="checkbox"/>	<input type="checkbox"/>	2020/05/05 16:39:38	0903447001	[Message Content]
<b>4.</b>	<input type="checkbox"/>	<input type="checkbox"/>	2020/03/08 11:38:35	0906180674	[Message Content]
<b>5.</b>	<input type="checkbox"/>	<input type="checkbox"/>	2020/03/08 11:38:35	0906180674	[Message Content]
<b>6.</b>	<input type="checkbox"/>	<input type="checkbox"/>	2020/03/08 11:38:35	0906180674	[Message Content]
<b>7.</b>	<input type="checkbox"/>	<input type="checkbox"/>	2020/07/08 11:18:45	0906180674	[Message Content]
<b>8.</b>	<input type="checkbox"/>	<input type="checkbox"/>	2020/07/08 11:18:45	0906180674	[Message Content]
<b>9.</b>	<input type="checkbox"/>	<input type="checkbox"/>	2020/07/22 14:08:35	988	[Message Content]

Available settings are explained as follows:

Item	Description
Mark as Read	Those SMS in "unread" state are shown in bold text. If you want to change SMS into "read" state, select them and click the OK button. Checking the checkbox in title will select all "unread" SMS in this page.
Delete	If you want to delete SMS, select them and click the OK button. Checking the checkbox in title will select all SMS in this page.
Index	If you want to read the full content of the message of the

---

SMS, click the index link of that SMS to open the following page. It will change all SMS of the message into "read" state.

LTE >> SMS Inbox

---

Index No.17

<b>Date:</b>	2015/09/11 14:33:08
<b>From:</b>	+ [REDACTED]
<b>Message Content:</b>	123

Message Content - Display the full content of the message.

OK - Return to previous page.

Delete - Click it to delete all SMS of this message and return to previous page.

Next - Click it to see the content of next SMS index.

---

## II-7-3 Send SMS

This page is used to send SMS messages by the LTE SIM card. It also displays the number of SMS required to send the message.

LTE >> Send SMS

**Send SMS Message**

Recipient Number

Data Coding Scheme English Only (GSM 7-bit) ▾

Message  0 / 160 characters (1 SMS)

---

[View SMS Outbox Cache](#)

Available settings are explained as follows:

Item	Description																																								
Recipient Number	Enter the phone number of the recipient. The format can be an international phone number (+886912345678) or a general phone number(0912345678).																																								
Data Coding Scheme	The router will automatically select a suitable Data Coding Scheme according to the current content in Message. GSM 7-bit and UCS-2 are supported.																																								
Message	Enter the message content to send. The total number of characters that you can Enter this field is 1024.																																								
Send Message	Click it to send this SMS message to the recipient immediately.																																								
View <a href="#">SMS Outbox Cache</a>	Display the record of SMS messages sent from the Router. <div style="border: 1px solid black; padding: 5px; margin-top: 5px;"> <p>LTE &gt;&gt; SMS Outbox Cache</p> <hr/> <p><b>LTE SMS Outbox Cache</b></p> <table border="1" style="width: 100%; border-collapse: collapse;"> <thead> <tr> <th>Details</th> <th>Delete</th> <th>Date</th> <th>To</th> <th>Message</th> </tr> </thead> <tbody> <tr> <td><a href="#">View</a></td> <td><input type="checkbox"/></td> <td>2015/10/05 03:12:06</td> <td>1234567890</td> <td>55555555555555555555</td> </tr> <tr> <td><a href="#">View</a></td> <td><input type="checkbox"/></td> <td>2015/10/05 03:12:01</td> <td>1234567890</td> <td>44444444444444444444</td> </tr> <tr> <td><a href="#">View</a></td> <td><input type="checkbox"/></td> <td>2015/10/05 03:11:56</td> <td>1234567890</td> <td>33333333333333333333</td> </tr> <tr> <td><a href="#">View</a></td> <td><input type="checkbox"/></td> <td>2015/10/05 03:11:51</td> <td>1234567890</td> <td>22222222222222222222</td> </tr> <tr> <td><a href="#">View</a></td> <td><input type="checkbox"/></td> <td>2015/10/05 03:11:46</td> <td>1234567890</td> <td>1111111</td> </tr> <tr> <td><a href="#">View</a></td> <td><input type="checkbox"/></td> <td>2015/10/05 03:07:55</td> <td>1234567890</td> <td>居易科技於1997年成立，</td> </tr> <tr> <td><a href="#">View</a></td> <td><input type="checkbox"/></td> <td>2015/10/05 03:04:38</td> <td>1234567890</td> <td>Test Test Nancy 123</td> </tr> </tbody> </table> <p><small>Note: Records in Outbox Cache are NOT preserved after replacement of newer records or Router reboot.</small></p> <p style="text-align: center;"><input type="button" value="OK"/></p> </div>	Details	Delete	Date	To	Message	<a href="#">View</a>	<input type="checkbox"/>	2015/10/05 03:12:06	1234567890	55555555555555555555	<a href="#">View</a>	<input type="checkbox"/>	2015/10/05 03:12:01	1234567890	44444444444444444444	<a href="#">View</a>	<input type="checkbox"/>	2015/10/05 03:11:56	1234567890	33333333333333333333	<a href="#">View</a>	<input type="checkbox"/>	2015/10/05 03:11:51	1234567890	22222222222222222222	<a href="#">View</a>	<input type="checkbox"/>	2015/10/05 03:11:46	1234567890	1111111	<a href="#">View</a>	<input type="checkbox"/>	2015/10/05 03:07:55	1234567890	居易科技於1997年成立，	<a href="#">View</a>	<input type="checkbox"/>	2015/10/05 03:04:38	1234567890	Test Test Nancy 123
Details	Delete	Date	To	Message																																					
<a href="#">View</a>	<input type="checkbox"/>	2015/10/05 03:12:06	1234567890	55555555555555555555																																					
<a href="#">View</a>	<input type="checkbox"/>	2015/10/05 03:12:01	1234567890	44444444444444444444																																					
<a href="#">View</a>	<input type="checkbox"/>	2015/10/05 03:11:56	1234567890	33333333333333333333																																					
<a href="#">View</a>	<input type="checkbox"/>	2015/10/05 03:11:51	1234567890	22222222222222222222																																					
<a href="#">View</a>	<input type="checkbox"/>	2015/10/05 03:11:46	1234567890	1111111																																					
<a href="#">View</a>	<input type="checkbox"/>	2015/10/05 03:07:55	1234567890	居易科技於1997年成立，																																					
<a href="#">View</a>	<input type="checkbox"/>	2015/10/05 03:04:38	1234567890	Test Test Nancy 123																																					



## II-7-4 SMS Gateway

Vigor router can serve as an SMS Gateway for sending alerts via SMS to mobile phones.

Take a look at the following two pictures.

The IP cameras connect to Router A and Router B via LAN. Where there is something wrong with IP camera, Router A can only send the SMS with alerts/warning message via a specified service provider on Internet.

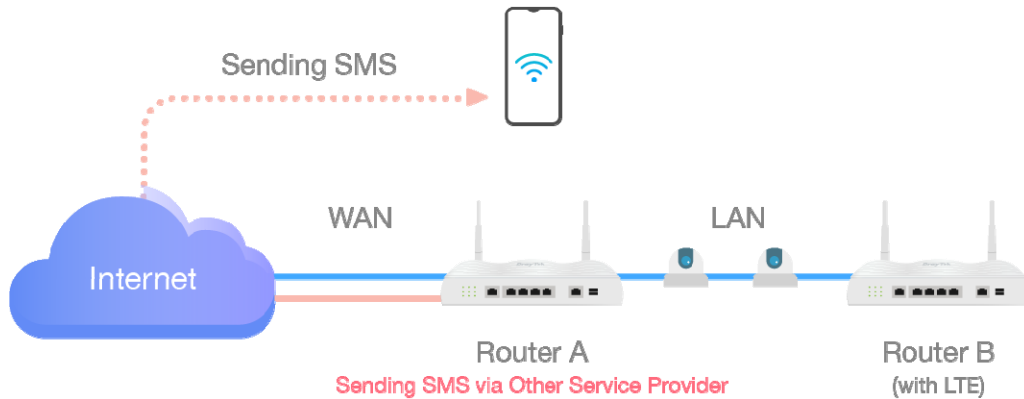

With the feature of SMS Gateway on Router B, even Router A is offline, router B could serve as an SMS Gateway that can send SMS (related to alerts or other events) to mobile phones directly.

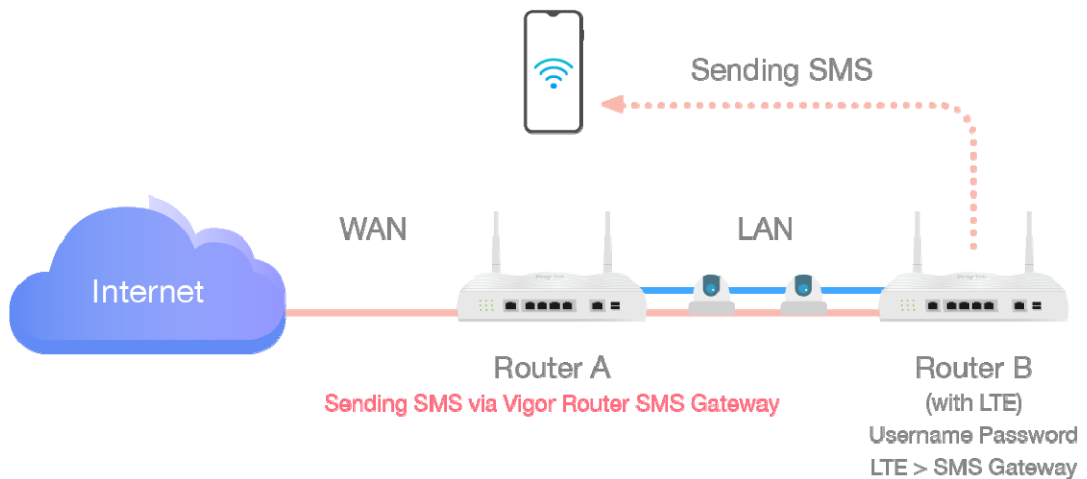

For router B, simply open LTE>>SMS Gateway and set a pair of username and password.

**SMS Gateway Setting**

Enable SMS Gateway

Username:

Password:

Confirm Password:

Password Strength: Weak Medium Strong

Strong password requirements:

1. Have at least one upper-case letter and one lower-case letter.
2. Including non-alphanumeric characters is a plus.

**Note:**

1. Password can contain a-z A-Z 0-9 , ; : . " < > \* + = | ? @ # ^ ! ( )
2. Password can't be all asterisks(\*). For example, '\*'\*' or '\*\*\*\*' is illegal, but '\*123\*' or '\*45' is OK.
3. Please enable HTTP or HTTPS server to allow SMS Gateway to work Remotely on System Maintenance >> Management page.

OK

Available settings are explained as follows:

Item	Description
Enable SMS Gateway	Check the box to enable SMS gateway of this router.
Username	Define a username.
Password	Define a password.
Confirm Passowrd	Enter the password again.

Below shows the settings configured on Router A and Router B.

1. Connect Router A and Router B (with LTE module).
2. On Router B, set a pair of username (e.g., SGauthenticate) and password on LTE>>SMS Gateway.

**SMS Gateway Setting**

Enable SMS Gateway

Username:

Password:

Confirm Password:

Password Strength: Weak Medium Strong

Strong password requirements:

1. Have at least one upper-case letter and one lower-case letter.
2. Including non-alphanumeric characters is a plus.

**Note:**

1. Password can contain a-z A-Z 0-9 , ; : . " < > \* + = | ? @ # ^ ! ( )
2. Password can't be all asterisks(\*). For example, '\*'\*' or '\*\*\*\*' is illegal, but '\*123\*' or '\*45' is OK.
3. Please enable HTTP or HTTPS server to allow SMS Gateway to work Remotely on System Maintenance >> Management page.

OK

3. On Router A, open Object Settings >> SMS/Mail Service Object>>Service Provider. Click any index number (e.g., #1 in this case) to open the following page. Select Vigor

Router SMS Gateway as the service provider. Set the WAN IP or LAN IP of this router in IP field.

Objects Setting >> SMS / Mail Service Object

Profile Index: 1

Profile Name	<input type="text" value="User_SMS"/>
Service Provider	<input type="text" value="Vigor Router SMS Gateway"/>
Connection Protocol	<input checked="" type="radio"/> HTTP <input type="radio"/> HTTPS
IP	<input type="text" value="192.168.1.1"/>
Username	<input type="text" value="SGauthenticate"/>
Password	<input type="password" value="*****"/>
Quota	<input type="text" value="10"/>
Sending Interval	<input type="text" value="3"/> (seconds)

Note:

1. Only one message can be sent during the "Sending Interval" time.
2. If the "Sending Interval" was set to 0, there will be no limitation.

As for username and password, please enter the same values as configured in Step 2.

4. Next, go to Objects Setting >> Notification Object. Select disconnection or connection of WAN, VPN tunnel and click OK to save the setting on Router A.

Objects Setting >> Notification Object

Profile Index: 1

Profile Name	<input type="text" value="WAN_Notify"/>	
<b>Category</b>	<b>Status</b>	
<b>WAN</b>	<input checked="" type="checkbox"/> Disconnected	<input checked="" type="checkbox"/> Reconnected
	<input type="checkbox"/> Disconnected	<input type="checkbox"/> Reconnected
<b>VPN Tunnel</b>	<input type="checkbox"/> Downtime Limit	
	<input type="text" value="60~3600"/> seconds	
<b>Temperature Alert</b>	<input type="checkbox"/> USB Out of Range	
<b>WAN Budget</b>	<input type="checkbox"/> Limit Reached	
<b>Central VPN Management</b>	<input checked="" type="checkbox"/> CPE Offline	
	<input type="checkbox"/> CPE Config Backup Fail	
	<input type="checkbox"/> CPE Config Restore Fail	
	<input type="checkbox"/> CPE Firmware Upgrade Fail	
	<input type="checkbox"/> CPE VPN Profile Setup Fail	
<b>High Availability</b>	<input type="checkbox"/> Failover Occurred	
	<input type="checkbox"/> Config Sync Fail	
	<input type="checkbox"/> Router Unstable	
<b>Security</b>	<input type="checkbox"/> Web Log-in	
	<input type="checkbox"/> Telnet Log-in	
	<input type="checkbox"/> SSH Log-in	
	<input type="checkbox"/> TR069 Log-in	
	<input type="checkbox"/> FTP User Log-in	
	<input type="checkbox"/> Config Changed(From WebUI and CLI)	

Note:

1. When High Availability is enabled, "Sending Interval" of **SMS Provider profile** should set to 0.
2. When the VPN Downtime limit is enabled, Vigor Router will not send the VPN Down alert immediately. It will send the Alert after the Downtime limit period if the VPN still doesn't go up.

5. Once the router A encounters the condition set above, router B (as an SMS gateway) will send out an SMS to the recipient.

For a user who owns a non-DrayTek LTE router, there is one way to send the SMS to mobile phones through the non-DrayTek LTE router and DrayTek router.

1. Make sure the DrayTek router and the non-DrayTek LTE router are connected via LAN.
2. Obtain the exact URL string from non-DrayTek LTE router.
3. On DrayTek router, open Objects Setting>>SMS/Mail Service Object and click the number link #9 or #10 to customize SMS service object.

Objects Setting >> SMS / Mail Service Object

Profile Index: 9

Profile Name	<input type="text" value="Custom 1"/>
Service Provider	<input type="text"/>
	<pre>https://192.168.1.1/cgi-bin/sms_send? username=userotherbrand&amp;password=admin123456&amp;number=testtest&amp;text=the_WAN_is_ offline</pre>
Please contact with your SMS provide to get the exact URL String eg:bulksms.vsms.net:5567/eapi/submission/send_sms/2/2.0?username=###txtUser###&password=###txtPwd###&msisdn=###txtDest###&message=###txtMsg###	
Server Response	<input type="text" value="Max: 31 characters"/>
Username	<input type="text" value="userotherbrand"/>
Password	<input type="password" value="*****"/>
Quota	<input type="text" value="10"/>
Sending Interval	<input type="text" value="3"/> (seconds)

Note:

1. Only one message can be sent during the "Sending Interval" time.
2. If the "Sending Interval" was set to 0, there will be no limitation.

Enter the data coming from the non-DrayTek LTE router, e.g., the URL string, the username, password, and warning message on the entry box.

4. Click OK to save the settings.

## II-7-5 Router Commands

This page allows the user to set function to reboot Vigor router remotely and get the router status via SMS.

### Get Router Status or Reboot Router via SMS Message

#### Get Router Status



#### Reboot Router

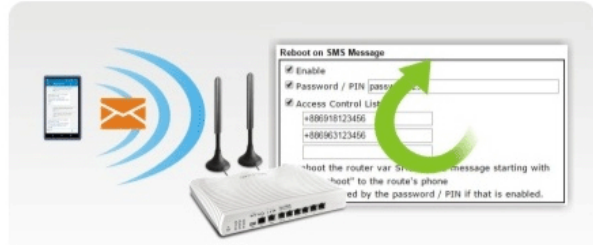

Go to LTE>>Router Commands to get the following page.

LTE >> Router Commands

#### Reboot on SMS Message

Enable with Password / PIN

Access Control List

List	Phone Number
1	<input type="text"/>
2	<input type="text"/>
3	<input type="text"/>

**Note:**

To reboot the router via SMS, send a message starting with "remote reboot", followed by Password/PIN (e.g. remote reboot 1234) to the router's phone number.

#### Reply with Router Status Message

Enable with Password / PIN

Access Control List

List	Phone Number
1	<input type="text"/>
2	<input type="text"/>
3	<input type="text"/>

**Message Contents**

- Router Name     WAN1 IP     WAN1 Data Usage  
 Router Up-Time     WAN2 IP     WAN2 Data Usage  
 Firmware Version     WAN3 IP     WAN3 Data Usage  
 MAC Address     WAN4 IP     WAN4 Data Usage  
 LTE IP     LTE Data Usage  
 WAN6 IP     WAN6 Data Usage

SMS Number per Status Response : 0

**Note:**

To get status information from the router, send a message starting with "router status", followed by the password/PIN (e.g. router status 1234) to the router's phone number.

**Note:** Phone numbers in the Access Control List should be in international format (e.g., +886123456789).

OK

Available settings are explained as follows:

Item	Description
<b>Reboot on SMS Message</b>	
Enable with Password / PIN	To reboot Vigor router remotely via SMS, please check such box and Enter the password/PIN number (treated as authentication for any mobile phone). The password shall be composed by letters, numbers and baseline.

Access Control List	<p>Check the box to type or modify (up to 3) phone numbers. The phone number specified here is capable of sending SMS to reboot such Vigor router remotely.</p> <p>Note: If such option is enabled, only mobile phones specified here are allowed to send SMS to reboot Vigor router if correct password is given. That is, if it is disabled (unchecked), any mobile phone can send SMS to reboot such Vigor router if correct password is given.</p>
<b>Reply with Router Status Message</b>	
Enable with Password / PIN	<p>Users can get the WAN data usage and basic information about Vigor router (e.g., IP address, MAC address) through the mobile phone by entering the password/PIN specified in this field.</p> <p>The password shall be composed by letters, numbers and baseline.</p>
Access Control List	<p>Check the box to type or modify (up to 3) phone numbers. The phone number specified here is capable of getting related information about Vigor router remotely.</p> <p>Note: If such option is enabled, only mobile phones specified here are allowed to obtain related information about Vigor router if correct password is given. That is, if it is disabled (unchecked), any mobile phone can get the data of Vigor router if correct password is given.</p>
Message Contents	<p>There are several types of message contents for you to select. Choose and check the required item, then Vigor router will offer the status response about that item via SMS.</p>
SMS messages per status response	<p>Display the total number of the type for status response.</p> <p>Display the total number of SMS required to send the status message which contains the current selected Message Contents.</p>

## II-7-6 Status

Vigor router with LTE function is capable of accessing into Internet and able to send SMS to specified mobile phone. In addition, it can be treated as a LTE modem.

This page will display basic information about the embedded LTE module and the current LTE connection.

LTE >> Status

[Refresh](#)

LTE Modem	
Status:	Operational
IMEI:	861107031196273
IMSI:	466924102353176
ICCID:	89886920041023531764
Access Tech:	LTE
Band:	E-UTRA Op Band 8
Operator:	46692
Mobile Country Code:	466
Mobile Network Code:	92
Location Area Code:	65534
Cell ID:	80439842
RSRP Signal:	-99 dBm (Good)
RSSI Signal:	-61 dBm (Excellent)
Active Channel:	3650
Max Channel TX Rate:	50 Mbps
Max Channel RX Rate:	150 Mbps
LTE Bridge	
LTE Bridge mode:	Disabled
LTE Bridge specific MAC:	YES
LTE Bridged MAC:	00:1D:AA:11:22:33
LTE Bridged IP:	0.0.0.0
LTE Bridged Gateway IP:	0.0.0.0
LTE SMS	
SMS Centre Number:	+886932400851
SMS Service Status:	Ready
SMS Loading:	Not ready
New SMS:	---

Each item is explained as follows:

Item	Description
LTE Modem	
Status	LTE WAN status.
IMEI	International Mobile Equipment Identity of the embedded LTE module.
IMSI	International Mobile Subscriber Identity of the LTE SIM card.
Access Tech	Type of LTE connection (CDMA/GSM/WCDMA/LTE/TD-SCDMA).
Band	Band of LTE connection.
Operator	ISP name of LTE connection.

Mobile Country Code / Mobile Network Code / Location Area Code / Cell ID :	Base station information.
Signal	Signal strength of LTE connection.
Active Channel	Frequency of LTE connection.
Interference with 2.4GHz WLAN	Whether the current LTE frequency causes interference with 2.4G wireless. If Yes, the interfered 2.4G wireless channels will be indicated.
Max Channel TX Rate / Max Channel RX Rate	Maximum TX/RX link rate of LTE connection.
LTE SMS	
SMS Centre Number	The phone number for SMS service of the LTE SIM card.
SMS Service status	Whether the SMS service of the LTE SIM card is ready.
SMS Loading	Whether the received SMS messages in the LTE SIM card have been loaded to the Router.
New SMS	The number of unread SMS in SMS Inbox.



# Part III Wireless LAN



Wireless

Wireless LAN enables high mobility so WLAN users can simultaneously access all LAN facilities just like on a wired LAN as well as Internet access.

## III-1 Wireless LAN (2.4GHz/5GHz)

This function is available on wireless models only (models with -ax or -ac suffixes).

In recent years, the market for wireless communications has enjoyed tremendous growth. Wireless technology now reaches virtually every location on earth. Billions of people exchange information daily with wireless communication products. The Vigor2927 series of wireless routers (with “n”, “n-plus”, or “ac” in the model name), designed with maximum flexibility and efficiency in mind, is ideal for use in a small office or home. In a business environment, any authorized personnel can bring a WLAN-equipped tablet, PDA or notebook into a meeting room and connect to the network without drilling holes through walls or tearing up flooring to lay a clot of LAN cabling. Wireless networking enables high mobility so WLAN users can access all LAN resources in the same manner just as they would on a wired LAN, but without the cables.

All Vigor2927 wireless routers support 2.4 GHz. ac models add support for 5 GHz frequencies. Channel operations of 20 and 40 MHz are possible on the 2.4 GHz spectrum, and 20, 40 and 80 MHz are supported on the 5 GHz spectrum. “ac” models (2865ac) support data rates of up to 1.3 Gbps on 802.11ac 80 MHz channels, whereas “n” models support data rates of up to 300 Mbps on 802.11n 40 MHz channels.



### Info

The actual data throughput will vary according to the network conditions and environmental factors, including volume of network traffic, network overhead and building materials.

In an Infrastructure Mode of wireless network, Vigor wireless router plays a role as an Access Point (AP) connecting to lots of wireless clients or Stations (STA). All the STAs will share the same Internet connection via Vigor wireless router. The wireless network settings, such as SSID, channels, encryption protocol, can be configured in General Settings.

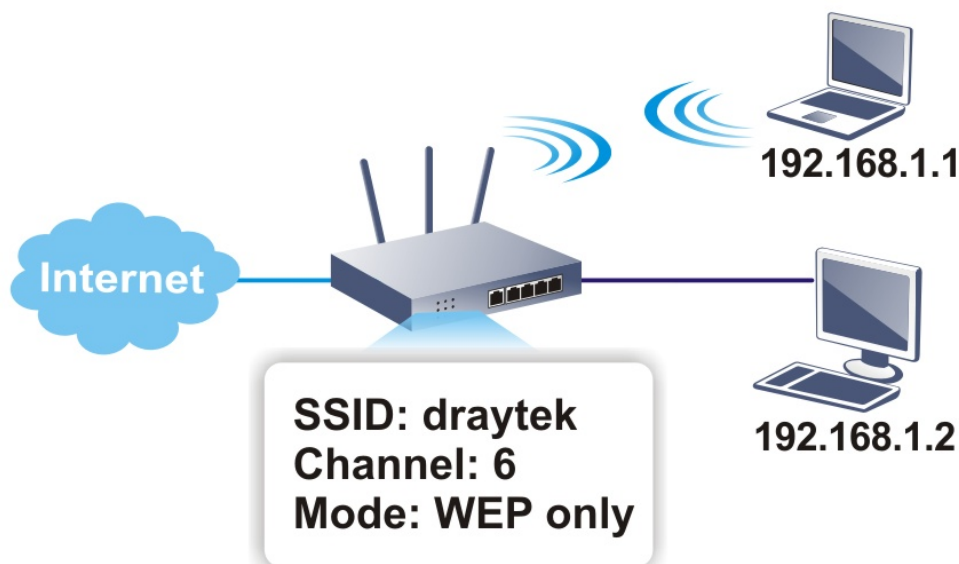

### Multiple SSIDs

Vigor wireless routers support up to four SSIDs (Service Set Identifiers) per band for wireless connections. A service set is a group of wireless network clients that have the same

networking parameters. Each service set can be configured to have a unique name (SSID) and specific download and upload rates, and can be used by different categories of users.

### Real-time Hardware Encryption

Vigor wireless routers are equipped with a hardware AES encryption engine to provide the most effective and efficient protection of wireless traffic, without sacrificing user experience.

### Complete Security Standard Selection

To ensure the security and privacy of your wireless communication, we provide several prevailing standards on market.

WEP (Wired Equivalent Privacy) is a legacy method to encrypt each frame transmitted via radio using either a 64-bit or 128-bit key. Usually access point will preset a set of four keys and it will communicate with each station using only one out of the four keys.

WPA (Wi-Fi Protected Access), the most dominating security mechanism in industry, is separated into two categories: WPA-personal or called WPA Pre-Share Key (WPA/PSK), and WPA-Enterprise or called WPA/802.1x.

In WPA-Personal, a pre-defined key (PSK) is used to encrypt traffic during data transmission. WPA uses the Temporal Key Integrity Protocol (TKIP) for data encryption whereas WPA2 applies AES (Advanced Encryption Standard). A major advantage of WPA-Enterprise is that it supports not only encryption but also authentication.

You should select the appropriate security mechanism according to your needs. Because WEP has proven to be vulnerable to attacks, you should consider using WPA instead for the most secure connection. No matter which security suite you select, they all will enhance the over-the-air data protection and /or privacy on your wireless network. The Vigor wireless router is very flexible and can support multiple secure connections with both WEP and WPA at the same time.



---

#### Info

The default password (PSK) is listed on a label attached to the bottom of the router. Since anyone who has physical access to the router can discover the default password, you are strongly advised to change it.

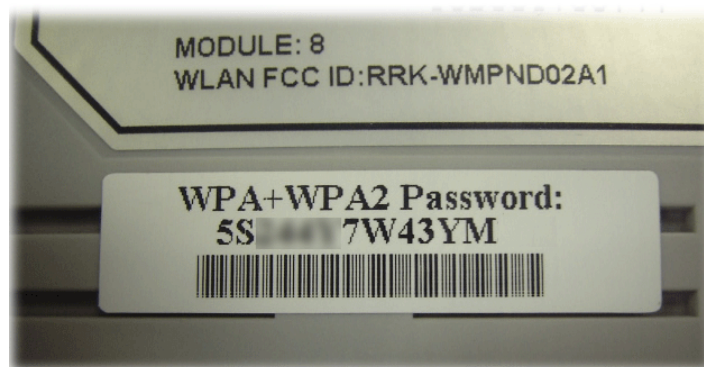

---

### Separate the Wireless and the Wired LAN- WLAN Isolation

WLAN Isolation allows you to separate wireless LAN clients from wired ones, either for the purpose of quarantining certain users, or restricting their access to LAN resources. When WLAN isolation is enabled on an SSID, its users will only be able to connect to the WAN (i.e., internet). This is ideal for providing visitors Internet access while keeping the wired network secure.

For the highest degree of security, you may consider adding firewall rules to filter access by MAC address.

## Manage Wireless Stations - Station List

All stations on the wireless network and their connection status is shown here.

### DFS Restrictions

In certain parts of the world, there are radar systems that are primary users of the 5 GHz band. WLAN equipment on the 5 GHz band is considered secondary users and must not cause interference to the primary users. By utilizing a feature called Dynamic Frequency Selection, the wireless router detects the presence of radar signals and relocates the wireless network to a clear channel. DFS channels vary by region, and we must obtain certification from the authorities before making them available for use on the Vigor router. We are working on DFS certification in Europe and will open up those channels by releasing new firmware once we pass certification. In Europe, these DFS channels will be made available 52, 56, 60, 64, 100, 104, 108, 112, 116, 120, 124, 128, 132, 136 and 140.

At this time, we have no plans to pursue DFS certification in the USA, so DFS channels will not be available in the foreseeable future. The U.S. DFS channels 52, 56, 60, 64, 100, 104, 108, 112, 116, 120, 124, 128, 132, 136 and 140 will not be available on routers sold in the United States.

In the rest of world, there are restrictions on DFS channels as well. Uncertified DFS channels will be unavailable for selection depending on the country code programmed in the router.

### WPS

WPS (Wi-Fi Protected Setup) makes connecting wireless clients to wireless access points and routers a simple process.



---

## Web User Interface

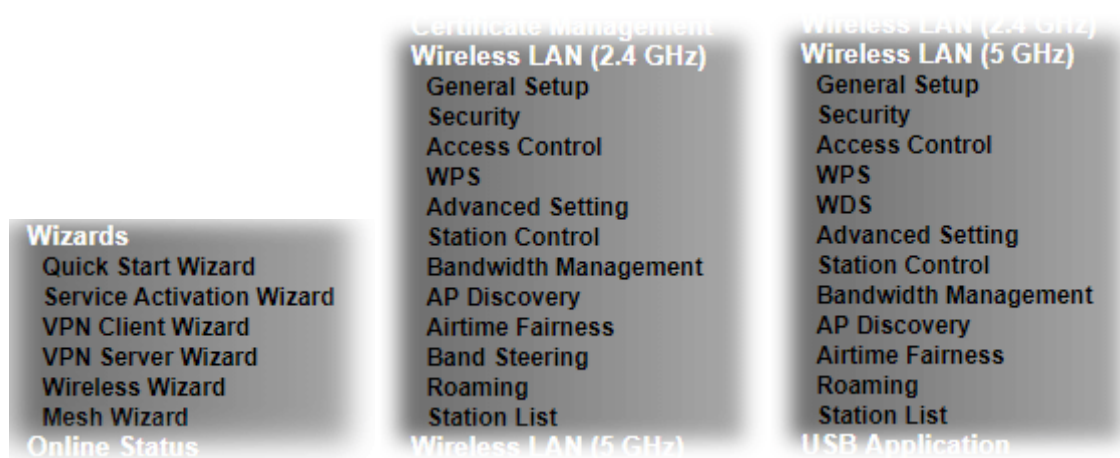

---

### III-1-1 Wireless Wizard

On Wi-Fi-equipped models, you can configure the wireless access point (AP) using the Wireless Wizard. The Host AP Configuration sets up SSID 1 for use by internal users, who are allowed to access both the LAN and the WAN (Internet), whereas the Guest AP Configuration sets up SSID 2 for use by visitors, who are allowed only WAN access and whose access speeds can optionally be throttled.

The Wireless Wizard allows you to quickly configure a host SSID (for internal use, such as in a home or business environment), and optionally a guest SSID (for wireless clients that are restricted to Internet access only, typically used by visitors).

Follow the steps listed below:

1. On the menu bar, click on Wizards, and then Wireless Wizard.
2. The Host AP Configuration page appears. This page sets up SSID 1 for use by internal users. SSID 1 configured using the wizard will have no access speed throttling (by means of the Rate Control feature), and both the LAN and the WAN will be accessible.

Host AP Configuration

<b>Wireless 2.4GHz Settings</b>	
Name:	<input type="text" value="DrayTek"/>
Mode:	<input type="text" value="Mixed(11b+11g+11n)"/>
Channel:	<input type="text" value="Channel 6, 2437MHz"/>
Security Key:	<input type="password" value="....."/>
<b>Wireless 5GHz Settings</b>	
<input type="checkbox"/> Use the same SSID and Security Key as above	
Name:	<input type="text" value="DrayTek_5G"/>
Mode:	<input type="text" value="Mixed (11a+11n+11ac)"/>
Channel:	<input type="text" value="Channel 36, 5180MHz"/>
Security Key:	<input type="password" value="....."/>
<b>Note:</b> The host AP configured here will be used for home or internal company use.	

Available settings are explained as follows:

User-configurable Item	Description
<b>Wireless 2.4GHz Settings</b>	
Name	Service Set Identification (SSID), which shows up as the AP identifier. Maximum length is 32 characters.
Mode	Allowed Wi-Fi modes. 802.11b is the original Wi-Fi mode on the 2.4 GHz band and supports raw data rates up to 11 Mbit/s. 802.11g allows for enhanced throughput up to 54 Mbit/s. 802.11n provides throughput up to 300 MHz. Available selections are <ul style="list-style-type: none"> <li>• 11b Only</li> <li>• 11g Only</li> <li>• 11n Only (2.4 GHz)</li> <li>• Mixed(11b+11g)</li> <li>• Mixed(11g+11n)</li> <li>• Mixed(11b+11g+11n)</li> </ul> The selections labeled “Mixed” enable multiple simultaneously-active modes.
Channel	Wi-Fi channel used for this SSID. If set to Auto, the router uses the best available channel.
Security Key	The Pre-shared Key (PSK) used by WPA2/PSK (Wireless Protected Access 2/Pre-shared Key) to encrypt wireless traffic. The key is composed of 8 to 63 ASCII characters. You may also specify the key using 64 hexadecimal digits, prefixed with the sequence 0x (“0x321253abcde...”).
<b>Wireless 5GHz Settings</b>	
Use the same SSID and Security Key as above	If selected, the SSID Name and Security Key from the 2.4 GHz section will be used.

Name	Service Set Identification (SSID), which shows up as the AP identifier. Maximum length is 32 characters.
Mode	<p>Allowed Wi-Fi modes.</p> <p>802.11a is the original Wi-Fi mode on the 5 GHz band and supports raw data rates up to 11 Mbit/s.</p> <p>802.11n enhances the throughput and provides up to 300 MHz.</p> <p>The newest standard, 802.11ac, can achieve 1.3 Gbit/s of data throughput on the 5 GHz band.</p> <p>Available selections are</p> <ul style="list-style-type: none"> <li>• 11a Only</li> <li>• 11n Only (5GHz)</li> <li>• Mixed(11a+11n)</li> <li>• Mixed(11a+11n+11ac)</li> </ul> <p>The selections labeled “Mixed” enable multiple simultaneously-active modes.</p>
Channel	Wi-Fi channel used for this SSID. If set to Auto, the router uses the best available channel.
Security Key	The Pre-shared Key (PSK) used by WPA2/PSK (Wireless Protected Access 2/Pre-shared Key) to encrypt wireless traffic. The key is composed of 8 to 63 ASCII characters. You may also specify the key using 64 hexadecimal digits, prefixed with the sequence 0x (“0x321253abcde...”).
Next	Click it to get into the next setting page.
Cancel	Exit the wireless wizard without saving any changes.

3. Click Next to proceed to the Guest AP Configuration page. The Guest AP Configuration page appears. This page sets up SSID 2 for use by guest users. SSID 2 configured using the wizard can optionally be set up with access speed throttling (by means of the Rate Control feature), and only the WAN (the Internet) will be accessible.

SSID 2 shares the same Mode and Channel settings as SSID 1 configured on the previous page.

#### Wireless Wizard

#### Guest AP Configuration

**Wireless 2.4GHz Settings**

Enable  Disable

SSID:

Security Key:

Bandwidth Limit:  Enable Total Upload  kbps Total Download  kbps

**Wireless 5GHz Settings**

Enable  Disable

Use the same SSID and Security Key as above

SSID:

Security Key:

**Note:**  
The configured guest AP will not be able to access the LAN network, VPN connections, or communicate with wireless devices connecting to the router's other APs. This AP interface shall be used for Internet access only.

Available settings are explained as follows:





## III-1-2 General Setup

The Wireless LAN>>General Setup section lets you configure the most basic settings of your wireless network, including the SSIDs, WLAN channels and bandwidth control.

### Wireless LAN (2.4 GHz) >> General Setup

#### General Setting ( IEEE 802.11 )

Enable Wireless LAN

**Radio**

Mode:  ▼

Channel:  ▼

**SSID**

Index	Enable	Active	SSID	Hide SSID	Isolate Member	Isolate VPN	Mesh Sync VLAN ID
1	<input checked="" type="checkbox"/>	V	<input type="text" value="mk-2927"/>	<input type="checkbox"/>	<input type="checkbox"/>	<input type="checkbox"/>	0
2	<input type="checkbox"/>	-	<input type="text" value="DrayTek_Guest"/>	<input type="checkbox"/>	<input type="checkbox"/>	<input type="checkbox"/>	0
3	<input type="checkbox"/>	-	<input type="text" value="Max: 31 characters"/>	<input type="checkbox"/>	<input type="checkbox"/>	<input type="checkbox"/>	0
4	<input type="checkbox"/>	-	<input type="text" value="Max: 31 characters"/>	<input type="checkbox"/>	<input type="checkbox"/>	<input type="checkbox"/>	0

**Schedule**

Schedule	Schedule Profile	Apply To
Schedule 1	<input type="text" value="None"/> ▼	<input type="checkbox"/> SSID1(All) <input type="checkbox"/> SSID2 <input type="checkbox"/> SSID3 <input type="checkbox"/> SSID4
Schedule 2	<input type="text" value="None"/> ▼	<input type="checkbox"/> SSID1(All) <input type="checkbox"/> SSID2 <input type="checkbox"/> SSID3 <input type="checkbox"/> SSID4
Schedule 3	<input type="text" value="None"/> ▼	<input type="checkbox"/> SSID1(All) <input type="checkbox"/> SSID2 <input type="checkbox"/> SSID3 <input type="checkbox"/> SSID4
Schedule 4	<input type="text" value="None"/> ▼	<input type="checkbox"/> SSID1(All) <input type="checkbox"/> SSID2 <input type="checkbox"/> SSID3 <input type="checkbox"/> SSID4

**Note:**

1. Channel setting should not be changed while Wireless 2.4G WAN mode is in use.
2. Isolate Member: Prevent the clients associated with this SSID from accessing each other.
3. Isolate VPN: Block the wireless clients from accessing the VPN network and prevent wireless traffic being sent to VPN connections.
4. Only the action "Force Down" in the Schedule Profile will be applied to WLAN, other actions will be ignored.
5. When the router is in High Availability Hot-Standby method and it's the Secondary Router, the wireless function will be disabled.

Available settings are explained as follows:

Item	Description
Enable Wireless LAN	Check the box to enable wireless function.
<b>Radio</b>	
Mode	Select the 802.11 mode allowed on the band. On the 2.4 GHz band, the following wireless mode options are available: <ul style="list-style-type: none"> <li>• 11b Only</li> <li>• 11g Only</li> <li>• 11n Only (2.4 GHz)</li> <li>• Mixed (11b+11g)</li> <li>• Mixed (11g+11n)</li> <li>• Mixed (11b+11g+11n)</li> </ul> On the 5 GHz band on ac models (e.g., 2927ac), the following options are available: <ul style="list-style-type: none"> <li>• 11a Only</li> </ul>

	<ul style="list-style-type: none"> <li>• 11n Only (5 GHz)</li> <li>• Mixed (11a+11n)</li> <li>• Mixed (11a+11n+11ac)</li> </ul>															
Channel	Allows you to specify a particular wireless channel to use, or let the system determine the optimal channel by selecting “Auto”. The list of available channels varies depending on the locale for which the router is intended.															
<b>SSID</b>																
SSID	Service Set Identification (SSID), which shows up as the AP identifier. Maximum length is 32 characters.															
Hide SSID	Select to keep SSIDs from showing up when scans are performed by wireless clients, which makes it harder for unauthorized clients or STAs to join your wireless LAN. Depending on the wireless client and software used, the user may see only an AP listed without the SSID, or the AP might not even show up.															
Isolate	Member - Check this box to disallow communication between wireless clients (stations) on the same SSID. VPN - Check this box to block wireless clients (stations) from accessing VPN clients.															
Mesh Sync VLAN ID	Display the VLAN ID, which will synchronize copy to the mesh node using the same SSID.															
<b>Schedule</b>																
Schedule Profile	Set the wireless LAN to be disabled at certain time intervals. You may choose up to 4 schedules out of the 15 schedules defined in Applications >> Schedule. Only “Force Down” schedule profiles take effect, and the wireless function will be turned off for the duration of the profile. The default setting is blank for all schedules, meaning wireless function will always work.															
Apply To	<p>Selected SSID (2 /3 /4) will be forced up /down based on the schedule profile used.</p> <table border="1"> <thead> <tr> <th>Schedule</th> <th>Schedule Profile</th> <th>Apply To</th> </tr> </thead> <tbody> <tr> <td>Schedule 1</td> <td>None</td> <td><input checked="" type="checkbox"/> SSID1(All) <input checked="" type="checkbox"/> SSID2 <input checked="" type="checkbox"/> SSID3 <input checked="" type="checkbox"/> SSID4</td> </tr> <tr> <td>Schedule 2</td> <td>None</td> <td><input checked="" type="checkbox"/> SSID1(All) <input checked="" type="checkbox"/> SSID2 <input checked="" type="checkbox"/> SSID3 <input checked="" type="checkbox"/> SSID4</td> </tr> <tr> <td>Schedule 3</td> <td>None</td> <td><input checked="" type="checkbox"/> SSID1(All) <input checked="" type="checkbox"/> SSID2 <input checked="" type="checkbox"/> SSID3 <input checked="" type="checkbox"/> SSID4</td> </tr> <tr> <td>Schedule 4</td> <td>None</td> <td><input checked="" type="checkbox"/> SSID1(All) <input checked="" type="checkbox"/> SSID2 <input checked="" type="checkbox"/> SSID3 <input checked="" type="checkbox"/> SSID4</td> </tr> </tbody> </table>	Schedule	Schedule Profile	Apply To	Schedule 1	None	<input checked="" type="checkbox"/> SSID1(All) <input checked="" type="checkbox"/> SSID2 <input checked="" type="checkbox"/> SSID3 <input checked="" type="checkbox"/> SSID4	Schedule 2	None	<input checked="" type="checkbox"/> SSID1(All) <input checked="" type="checkbox"/> SSID2 <input checked="" type="checkbox"/> SSID3 <input checked="" type="checkbox"/> SSID4	Schedule 3	None	<input checked="" type="checkbox"/> SSID1(All) <input checked="" type="checkbox"/> SSID2 <input checked="" type="checkbox"/> SSID3 <input checked="" type="checkbox"/> SSID4	Schedule 4	None	<input checked="" type="checkbox"/> SSID1(All) <input checked="" type="checkbox"/> SSID2 <input checked="" type="checkbox"/> SSID3 <input checked="" type="checkbox"/> SSID4
Schedule	Schedule Profile	Apply To														
Schedule 1	None	<input checked="" type="checkbox"/> SSID1(All) <input checked="" type="checkbox"/> SSID2 <input checked="" type="checkbox"/> SSID3 <input checked="" type="checkbox"/> SSID4														
Schedule 2	None	<input checked="" type="checkbox"/> SSID1(All) <input checked="" type="checkbox"/> SSID2 <input checked="" type="checkbox"/> SSID3 <input checked="" type="checkbox"/> SSID4														
Schedule 3	None	<input checked="" type="checkbox"/> SSID1(All) <input checked="" type="checkbox"/> SSID2 <input checked="" type="checkbox"/> SSID3 <input checked="" type="checkbox"/> SSID4														
Schedule 4	None	<input checked="" type="checkbox"/> SSID1(All) <input checked="" type="checkbox"/> SSID2 <input checked="" type="checkbox"/> SSID3 <input checked="" type="checkbox"/> SSID4														

To save changes on the General Settings page, select OK; to discard changes, select Cancel.

### III-1-3 Security

Every router has a default wireless password (PSK) which is provided on a label attached to the bottom of the router. For the wireless client who wants to access into Internet through such router, please input the default PSK value for connection.

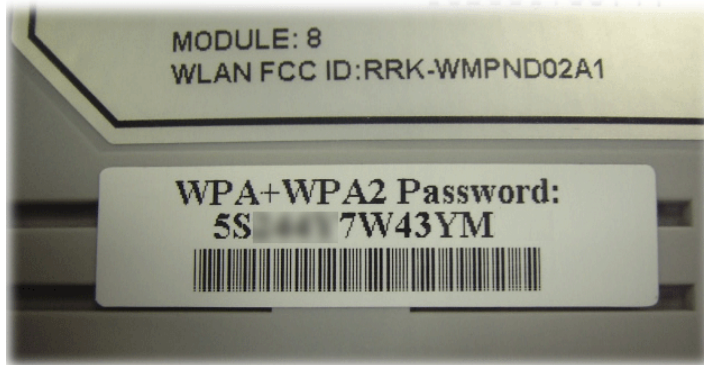

For extra security you can set your own wireless password by clicking the Wireless LAN>>Security Settings entry on the Web User Interface. Each of the 4 SSIDs can be configured independently using their own tab page.

Wireless LAN(2.4GHz) >> Security Settings

SSID 1	SSID 2	SSID 3	SSID 4
<p>SSID: DrayTek</p> <p>Mode: <input style="width: 100px;" type="text" value="Mixed(WPA+WPA2)/PSK"/></p> <p><u>WPA</u></p> <p>Encryption Mode: TKIP for WPA/AES for WPA2</p> <p>Pre-Shared Key(PSK): <input type="text" value="....."/></p> <p>Password Strength: <input type="button" value="Weak"/> <input type="button" value="Medium"/> <input type="button" value="Strong"/></p> <p>EAPOL Key Retry: <input checked="" type="radio"/> Enable <input type="radio"/> Disable</p> <p><b>Note:</b> Type 8~63 ASCII characters, for example: "cfgs01a2...". For strong passwords: 1. Use at least 12 characters. 2. Include at least 3 of the following 4 types of characters: digits, uppercase letters, lowercase letters, and non-alphanumeric characters (such as \$ % ^).</p> <p><u>WEP</u></p> <p>Encryption Mode: <input type="text" value="64-Bit"/></p> <p><input checked="" type="radio"/> Key 1 : <input style="width: 100px;" type="text"/></p> <p><input type="radio"/> Key 2 : <input style="width: 100px;" type="text"/></p> <p><input type="radio"/> Key 3 : <input style="width: 100px;" type="text"/></p> <p><input type="radio"/> Key 4 : <input style="width: 100px;" type="text"/></p> <p><b>Note:</b> For 64 bit WEP key configurations, please insert 5 ASCII characters, for example: "AB312". For 128 bit WEP key configurations, please insert 13 ASCII characters.</p> <p style="text-align: center;"><input type="button" value="OK"/> <input type="button" value="Cancel"/></p>			

Available settings are explained as follows:

Item	Description
Mode	This dialog box lists all available security modes.

	<p style="text-align: center;"></p> <p><b>Info</b> You should also set <u>Wireless LAN(2.4GHz) 802.1X Setting</u> simultaneously if 802.1x mode is selected.</p> <hr/> <p>Disable - Encryption mechanism is disabled.</p> <p>WEP - Allow only connections from WEP clients. Encryption key should be entered in the WEP Key section.</p> <p>WEP/802.1x Only - Accepts only WEP clients and the encryption key is obtained dynamically from RADIUS server with 802.1X protocol.</p> <p>Allow only connections from WEP clients. Encryption key is obtained from a RADIUS server using the 802.1X protocol.</p> <p>WPA/802.1x Only - Allow only connections from WPA clients. Encryption key is obtained from a RADIUS server using the 802.1X protocol.</p> <p>WPA2/802.1x Only- Allow only connections from WPA2 clients. Encryption key is obtained from a RADIUS server using the 802.1X protocol.</p> <p>Mixed (WPA+WPA2/802.1x only) - Allow connections from both WPA and WPA2 clients. Encryption key is obtained from a RADIUS server using the 802.1X protocol.</p> <p>WPA/PSK - Allow connections only from WPA clients. Encryption key should be entered in the PSK field.</p> <p>WPA2/PSK - Allow connections only from WPA2 clients. Encryption key should be entered in the PSK field.</p> <p>Mixed (WPA+ WPA2)/PSK - Allow connections from both WPA and WPA2 clients. Encryption key should be entered in the PSK field.</p> <p>WPA3/SAE - Allow connections only from WPA3 clients. Encryption key should be entered in the PSK field.</p> <p>Mixed (WPA2+ WPA3)/SAE - Allow connections from both WPA2 and WPA3 clients. Encryption key should be entered in the PSK field.</p> <p>OWE - WPA3 also introduces a new open and secure connection mode; "Opportunistic Wireless Encryption" (OWE). It allows the clients to connect without a password, ideal for hotspot networks, but the connection between each individual client is uniquely encrypted behind the scenes.</p>
WPA	<p>WPA encrypts each frame transmitted from the radio using the key, which is either entered in the PSK (Pre-Shared Key) field, or or automatically negotiated via 802.1x authentication from a RADIUS server.</p> <p>Pre-Shared Key (PSK) - Enter 8-63 ASCII characters, for example, "012345678..", or 64 hexadecimal digits with a leading "0x", for example, "0x321253abcde..".</p> <p>Password Strength - The system will display the strength of the password, indicated by the words "weak", "medium" or "strong".</p> <p>EAPOL Key Retry - The default setting is "Enable". It can make sure that the key will be installed and used once in order to prevent key reinstallation attack.</p>
WEP	<p>WEP keys can either be 64-bit or 128-bit.</p> <p>64-Bit - Either 5 ASCII characters, for example "12345", or 10 hexadecimal digitals with a leading "0x", such as</p>

	<p>“0x4142434445”.</p> <p>128-Bit - Either 13 ASCII characters, for example “ABCDEFGHJKLM”, or 26 hexadecimal digits with a leading “0x”, for example “0x414243444546474849A4B4C4D”.</p> <p>Up to four keys can be entered here, but only one key can be selected at any time. The keys can be entered in ASCII or Hexadecimal.</p> <p>All wireless devices intending to connect to the same SSID must support the same WEP encryption bit size and have the same key.</p>
--	--

To save changes on this page, select OK; to discard changes, select Cancel.

### III-1-4 Access Control

In the Access Control, the router may restrict wireless access to certain wireless clients only by referencing a MAC address black or white list. The user may block wireless clients by inserting their MAC addresses into a black list, or only allow certain wireless clients to connect by inserting their MAC addresses into a white list.

In the Access Control web page, users may configure the white/black list modes used by each SSID and the MAC addresses applied to their lists.

Wireless LAN (2.4 GHz) >> Access Control

**Access Control**

Enable Mac Address Filter   White List ▾ SSID1 DrayTek  
  White List ▾ SSID2 DrayTek\_Guest  
  White List ▾ SSID3  
  White List ▾ SSID4

---

**MAC Address Filter (Max. 64 entries)**

Index	Attribute	MAC Address	Apply SSID	Comment
<div style="border: 1px solid gray; min-height: 80px;"></div>				

Client's MAC Address :

Apply SSID :  SSID 1  SSID 2  SSID 3  SSID 4

Attribute :  s: Isolate the station from LAN

Comment :

---

Backup Access Control:  Upload From File:  未選擇任何檔案

**Note:**  
Support AP ACL configuration file restoration.

Available settings are explained as follows:

Item	Description
Enable Mac Address Filter	Select the SSIDs that you would like to have MAC Address filter enabled. Select White List or Black List in the combo box next to each enabled SSIDs.

	<p>White List - Only allow wireless clients whose MAC addresses are listed in the MAC Address Filter list.</p> <p>Black List - Only allow wireless clients whose MAC addresses are not listed in the MAC Address Filter list.</p>
MAC Address Filter	Displays all MAC addresses in the filter list.
Client's MAC Address	Manually enter the MAC address of wireless client.
Apply SSID	Select the SSIDs to which the above MAC address filter will be applied.
Attribute	s: Isolate the station from LAN - select to isolate the wireless client from LAN.
Comment	Enter a brief description for the specified client's MAC address.
Add	Add a new filter entry to the MAC Address filter list using the information entered above.
Delete	Delete the selected MAC address from the list.
Edit	Update the selected MAC address in the list using the information entered above.
Cancel	Clear the contents of all the above fields. This will discard all changes without saving to the MAC Address Filter list.
OK	Click to save the MAC Address Filter list.
Clear All	Remove all entries from the MAC Address Filter list.
Backup Access Control	Settings on this web page can be saved as a file which can be restored in the future by this device or other device.
Upload From File	Restore wireless access control settings and applied onto this device.

To save changes on this page, select OK.

---

### III-1-5 WPS

WPS (Wi-Fi Protected Setup) provides an easy way to connect wireless to wireless access points and routers with WPA or WPA2 encryption.



---

#### Info

WPS works with wireless stations with WPS or WPS2 support. It does not work with WEP.

---

It is the simplest way to build connection between wireless network clients and vigor router. Users do not need to select any encryption mode and type any long encryption passphrase to setup a wireless client every time. He/she only needs to press a button on wireless client, and WPS will connect for client and router automatically.

There are two methods to do network connection through WPS between AP and Stations: pressing the *Start PBC* button or using *PIN Code*.

#### Using the PBC button

On the Vigor router, press and hold the WPS button on the front panel for 2 seconds, or click the Start PBC button on the Wireless LAN>>WPS page in the Web User Interface. On the wireless station (for example, a laptop computer), press the WPS/Start PBC button on the network card.

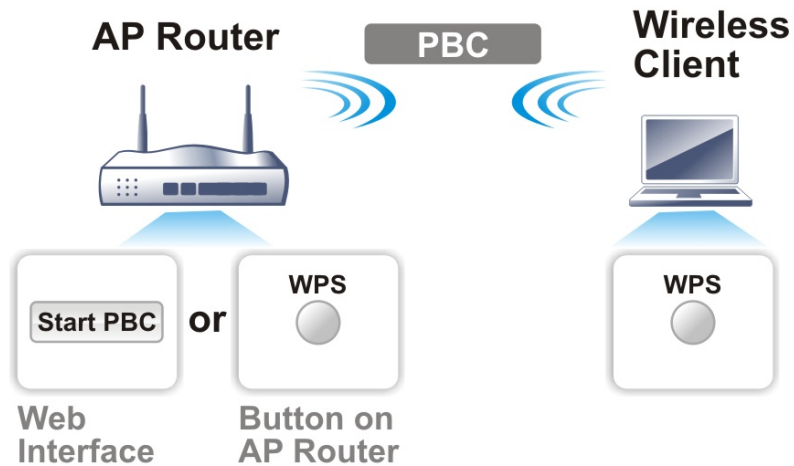

### Using a PIN code

You may establish a wireless connection by entering a PIN code generated by a wireless client that supports WPS.

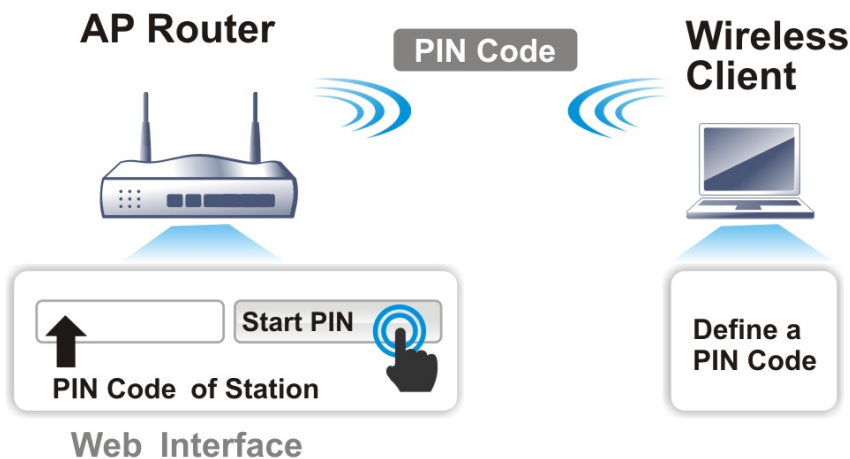

WPS is only supported when the encryption protocol is set to WPA-PSK or WPA2-PSK. If other protocols (such as WEP) have been selected in Wireless LAN>>Security, you will see the following message box:

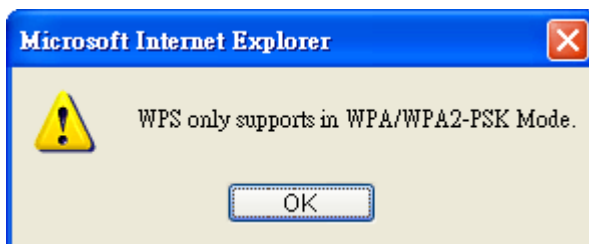

Please click OK to dismiss dialog box, return to Wireless LAN>>Security and select WPA-PSK or WPA2-PSK mode before attempting to enable WPS again.



Below shows Wireless LAN>>WPS web page:

Wireless LAN (2.4 GHz) >> WPS

Enable WPS 

Wi-Fi Protected Setup Information

WPS Status	Configured
SSID	DrayTek
Authentication Mode	Mixed(WPA2+WPA3)/SAE

Device Configure

Configure via Push Button	<input type="button" value="Start PBC"/>
Configure via Client PinCode	<input type="text"/> <input type="button" value="Start PIN"/>

Status: The Authentication Mode is NOT WPA2 PSK!!

**Note:**

WPS can help your wireless client automatically connect to the Access point.

: WPS is Disabled.

: WPS is Enabled.

: Waiting for WPS requests from wireless clients.

Available settings are explained as follows:

Item	Description
Enable WPS	Check this box to enable WPS setting.
WPS Status	Displays system information related to WPS. The message "Configured" means that the wireless security (encryption) function of the router is properly configured and functioning properly.
SSID	Displays the SSID1. WPS is supported on SSID1 only.
Authentication Mode	Displays the current authentication mode of the router.
Configure via Push Button	Click Start PBC to invoke Push-Button style WPS setup procedure. The router will wait for about 2 minutes for WPS connection requests from wireless clients. The WPS LED on the router will blink fast when WPS is in progress, and will return to normal condition after two minutes.
Configure via Client PinCode	Enter a PIN code, and click the Start PIN button. The WPS LED on the router will blink rapidly when WPS is in progress, for up to 2 minutes or until a successful WPS connection from a wireless client has been established.

### III-1-6 WDS (for 5GHz)

Wireless Distribution System (WDS) is a protocol for linking access points (AP) wirelessly. WDS supports two modes:

- Bridge mode, which bridges traffic between two LANs wirelessly.



- Repeater mode, which extends the coverage range of a WLAN.

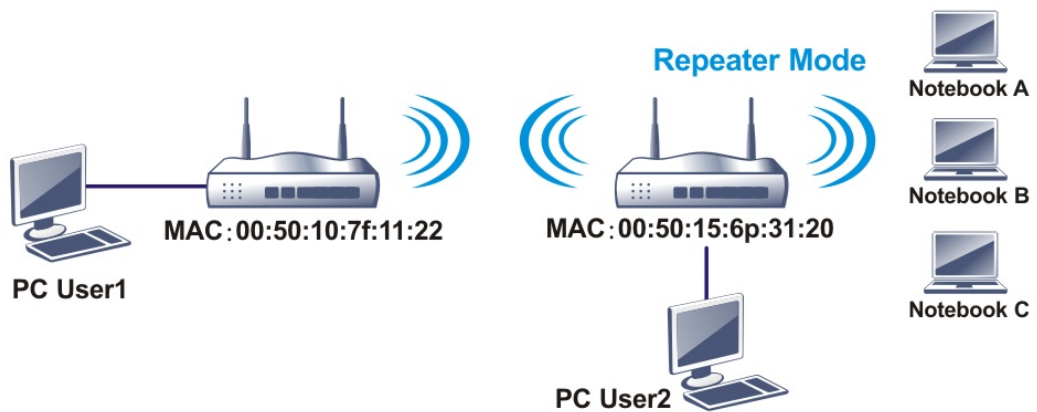

The **main** difference between these two modes is that, in Repeater mode, the packets received from one peer AP can be repeated to another peer AP through WDS links, whereas in Bridge mode, packets received from a WDS link will only be forwarded to local wired or wireless hosts. In other words, only Repeater mode can do WDS-to-WDS packet forwarding.

In the following example, hosts connected to Bridge 1 or 3 can communicate with hosts connected to Bridge 2 through WDS links. However, hosts connected to Bridge 1 cannot communicate with hosts connected to Bridge 3 through Bridge 2.

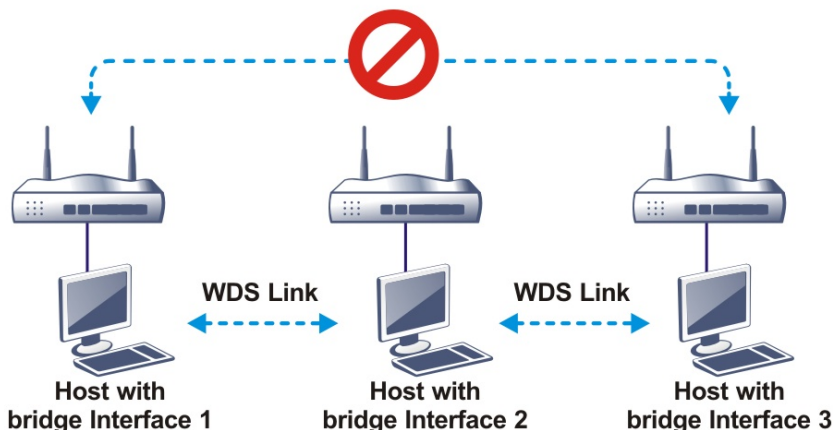

Click WDS from Wireless LAN menu. The following page will be shown.

Wireless LAN (5 GHz) >> WDS Settings

WDS Settings
| [Set to Factory Default](#) |

<p><b>Mode:</b> <span style="border: 1px solid gray; padding: 2px;">Disable</span> ▼</p> <hr/> <p><b>Security:</b></p> <p><input checked="" type="radio"/> Disable   <input type="radio"/> WEP   <input type="radio"/> Pre-shared Key</p> <hr/> <p><b>WEP:</b></p> <p>Use the same WEP key set in <a href="#">Security Settings</a>.</p> <hr/> <p><b>Pre-shared Key:</b></p> <p>Type:</p> <p><input type="radio"/> WPA   <input checked="" type="radio"/> WPA2</p> <p>Key: <span style="border: 1px solid gray; padding: 2px;">Max: 63 characters</span></p> <hr/> <p><b>Note:</b> WPA and WPA2 are not compatible with DrayTek WPA. Type 8~63 ASCII characters, for example: "cfigs01a2..."</p>	<p><b>Repeater</b></p> <p>Enable   Peer MAC Address</p> <p><input type="checkbox"/> <span style="border: 1px solid gray; padding: 2px;">  </span>:<span style="border: 1px solid gray; padding: 2px;">  </span>:<span style="border: 1px solid gray; padding: 2px;">  </span>:<span style="border: 1px solid gray; padding: 2px;">  </span>:<span style="border: 1px solid gray; padding: 2px;">  </span>:<span style="border: 1px solid gray; padding: 2px;">  </span></p> <p><input type="checkbox"/> <span style="border: 1px solid gray; padding: 2px;">  </span>:<span style="border: 1px solid gray; padding: 2px;">  </span>:<span style="border: 1px solid gray; padding: 2px;">  </span>:<span style="border: 1px solid gray; padding: 2px;">  </span>:<span style="border: 1px solid gray; padding: 2px;">  </span>:<span style="border: 1px solid gray; padding: 2px;">  </span></p> <p><input type="checkbox"/> <span style="border: 1px solid gray; padding: 2px;">  </span>:<span style="border: 1px solid gray; padding: 2px;">  </span>:<span style="border: 1px solid gray; padding: 2px;">  </span>:<span style="border: 1px solid gray; padding: 2px;">  </span>:<span style="border: 1px solid gray; padding: 2px;">  </span>:<span style="border: 1px solid gray; padding: 2px;">  </span></p> <p><input type="checkbox"/> <span style="border: 1px solid gray; padding: 2px;">  </span>:<span style="border: 1px solid gray; padding: 2px;">  </span>:<span style="border: 1px solid gray; padding: 2px;">  </span>:<span style="border: 1px solid gray; padding: 2px;">  </span>:<span style="border: 1px solid gray; padding: 2px;">  </span>:<span style="border: 1px solid gray; padding: 2px;">  </span></p> <hr/> <p><b>Access Point Function:</b></p> <p><input checked="" type="radio"/> Enable   <input type="radio"/> Disable</p> <hr/> <p><b>Status:</b></p> <p><input type="checkbox"/> Send "Hello" message to peers.</p> <p style="text-align: center;"><span style="border: 1px solid gray; padding: 2px;">Link Status</span></p> <hr/> <p><b>Note:</b> The status is valid only when the peer also supports this function.</p>
--	--

OK   Cancel

Available settings are explained as follows:

Item	Description
Mode	Choose the WDS mode. Disable - WDS is disabled. Repeater - WDS is enabled in Repeater mode.
Security	Choose one of the types for the router. The setting you choose here will make the following WEP or Pre-shared key field valid or not. Disable - Security is disabled. WEP - Security is enabled. Pre-shared key - Security is enabled.
Pre-shared Key	Type - Select either WPA or WPA2 as the encryption protocol. Key - Enter 8 ~ 63 ASCII characters or 64 hexadecimal digits with a leading "0x".
Repeater	If Repeater was selected as the WDS mode, enter the peer MAC addresses in these fields. Up to four peer MAC addresses may be entered in this page. Select the checkbox in front of a MAC address to enable it.
Access Point Function	Select Enable to make this router serve as an access point; select Disable to disable access point function.
Status	Click to send a "hello" message to peers. This only works if the peer also supports this function.

To save changes on this page, select OK; to discard changes, select Cancel.

## III-1-7 Advanced Setting

On this page you can configure advanced settings such as operation mode, channel bandwidth, guard interval, and aggregation MSDU for wireless data transmission.

If the Vigor router supports dual-band WLAN, you will see separate Advanced Setting sections for 2.4GHz and 5GHz.

### 2.4 GHz Advanced Setting page

Wireless LAN(2.4GHz) >> Advanced Setting

#### HT Physical Mode

Operation Mode	<input checked="" type="radio"/> Mixed Mode <input type="radio"/> Green Field
Channel Bandwidth	<input type="radio"/> 20 <input checked="" type="radio"/> 20/40 <input type="radio"/> 40
Guard Interval	<input type="radio"/> long <input checked="" type="radio"/> auto
Aggregation MSDU(A-MSDU)	<input checked="" type="radio"/> Enable <input type="radio"/> Disable
Long Preamble	<input type="radio"/> Enable <input checked="" type="radio"/> Disable
Packet-OVERDRIVE™ TX Burst	<input type="radio"/> Enable <input checked="" type="radio"/> Disable
Antenna	<input checked="" type="radio"/> 2T2R <input type="radio"/> 1T1R
Tx Power	<input checked="" type="radio"/> 100% <input type="radio"/> 80% <input type="radio"/> 60% <input type="radio"/> 30% <input type="radio"/> 20% <input type="radio"/> 10%
WMM Capable	<input checked="" type="radio"/> Enable <input type="radio"/> Disable
APSD Capable	<input type="radio"/> Enable <input checked="" type="radio"/> Disable
Rate Adaptation Algorithm	<input checked="" type="radio"/> New <input type="radio"/> Old
Fragment Length (256 - 2346)	<input type="text" value="2346"/> bytes
RTS Threshold (1 - 2347)	<input type="text" value="2347"/> bytes
Country Code	<input type="text"/> ( <a href="#">Reference</a> )
Isolate 2.4GHz and 5GHz bands	<input checked="" type="radio"/> Enable <input type="radio"/> Disable

OK

### 5 GHz Advanced Setting page:

Wireless LAN(5GHz) >> Advanced Setting

#### Physical Mode

Operation Mode	<input checked="" type="radio"/> Mixed Mode <input type="radio"/> Green Field
Channel Bandwidth	<input type="radio"/> 20 <input type="radio"/> 20/40 <input checked="" type="radio"/> 20/40/80
Guard Interval	<input type="radio"/> long <input checked="" type="radio"/> auto
Aggregation MSDU(A-MSDU)	<input checked="" type="radio"/> Enable <input type="radio"/> Disable
Tx Power	<input checked="" type="radio"/> 100% <input type="radio"/> 80% <input type="radio"/> 60% <input type="radio"/> 30% <input type="radio"/> 20% <input type="radio"/> 10%
WMM Capable	<input checked="" type="radio"/> Enable <input type="radio"/> Disable
APSD Capable	<input type="radio"/> Enable <input checked="" type="radio"/> Disable
RTS Threshold (1 - 2347)	<input type="text" value="2347"/> bytes
Country Code	<input type="text"/> ( <a href="#">Reference</a> )
Isolate 2.4GHz and 5GHz bands	<input checked="" type="radio"/> Enable <input type="radio"/> Disable

OK

Available settings are explained as follows:

Item	Description
Operation Mode	Mixed Mode - The router can transmit data using all protocols supported by 802.11a/b/g and 802.11n standards. However, all wireless transmissions will be slowed down

	<p>when any 802.11g or 802.11b wireless client is connected.</p> <p>Green Field - Select this mode to achieve the highest throughput. This mode supports data transmission between 802.11n systems only. In addition, it does not have protection mechanism to prevent conflicts with neighboring 802.11a/b/g devices.</p>
Channel Bandwidth	<p>20 -Vigor Router will utilize 20 MHz channels for data transmission and reception between the AP and wireless stations.</p> <p>40 -Vigor Router will utilize 40 MHz for data transmission and reception between the AP and wireless stations.</p> <p>20/40 - Vigor Router will utilize either 20 MHz or 40 MHz for data transmission and reception depending on the number of nearby wireless APs. 20MHz will be used when there are more than 10 wireless APs; otherwise 40MHz will be used. Selecting this setting ensures the best performance for data transit on networks with both 20 MHz and 40 MHz clients.</p>
Guard Interval	<p>Enabling this setting ensures the integrity of wireless traffic by inserting guard intervals between symbols to reduce the adverse effects of propagation delays, and signal multipath or reflections. If you choose auto as guard interval, the router will choose short guard interval (which increases wireless performance) or long guard interval for data transmit depending on the station capability.</p>
Aggregation MSDU (A-MSDU)	<p>Aggregation MSDU can combine frames of different sizes to improve performance at the MAC layer for clients from certain manufacturers. The default setting is Enable.</p>
Long Preamble	<p>This option determines the length of the sync field in an 802.11 packet. Most modern wireless network uses short preamble with 56 bit sync fields which yield better transmission speeds. However, some older 802.11b wireless devices only support long preamble which uses 128-bit sync fields. Click Enable to use Long Preamble to maintain compatibility with these devices.</p>
Packet-OVERDRIVE	<p>This feature can enhance the performance in data transmission about 40%* (by checking Tx Burst). It is active only when both the Access Point and Station (in wireless client) support and invoke this function at the same time.</p> <p>Note: Vigor N61 wireless adapter supports this function. Therefore, you can install it on your PC to take advantage of Packet-OVERDRIVE (Refer to the following picture of Vigor N61 wireless utility window: choose Enable for TxBURST on the Option tab).</p>

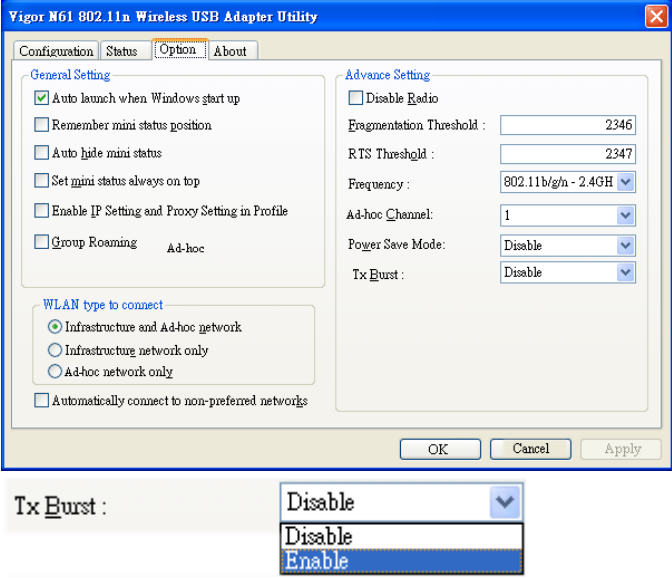
	 <p><b>Info</b> * Real transmission rate depends on the environment of the network.</p>
Antenna	Vigor router can be attached with two antennas to have good data transmission via wireless connection. However, if you have only one antenna attached, please choose 1T1R.
TX Power	Sets the power percentage of the access point's transmission signal. The greater the TX Power value, the higher intensity of the signal will be.
WMM Capable	WMM stands for Wi-Fi Multimedia. It provides basic Quality of Service (QoS) by prioritizing traffic based on four access categories defined in the IEEE 802.11e standard. The access categories are AC_VO, AC_VI, AC_BE and AC_BK, which corresponds to traffic types of voice, video, best effort and low priority (background) data, respectively. To apply WMM parameters to wireless data transmission, click the Enable radio button.
APSD Capable	APSD (Automatic Power-Save Delivery) is an enhancement over the power-saving mechanisms supported by Wi-Fi networks. It allows access points to buffer traffic before transmitting it to wireless devices, thus allowing wireless devices to enter into power saving mode which reduces power consumption. Not all wireless clients support APSD properly, and the only way to find out if APSD is appropriate for your network is to experiment. The default setting is Disable.
Rate Adaptation Algorithm	Sets the way the Wireless transmission rate is adjusted dynamically. In most cases, selecting "New" will result in better performance than "Old".
Fragment Length (256 - 2346)	Set the Fragment threshold. You are advised to leave the default value, 2346, untouched.
RTS Threshold (1 - 2347)	Minimize the collision (unit is bytes) between hidden stations to improve wireless performance. Set the RTS threshold. Do not modify default value if you

	<p>don't know what it is, default value is 2347.</p> <p>Adjusts the 802.11 maximum transmit frame size, which might reduce chances of collision with hidden stations. You are advised to leave the default value, 2347, untouched.</p>
Country Code	<p>Vigor router broadcasts country codes according to the 802.11d standard. However, some wireless stations will detect/scan access points looking for country codes to determine which country it is in, and utilize channels appropriate to the country. The wireless client might get confused if there are multiple access points in the vicinity broadcasting different country codes. In such cases, it might be necessary to change the country code of the access point to ensure these clients can successfully establish a wireless connection.</p>
Isolate 2.4GHz and 5GHz bands	<p>The default setting is "Enable". It means that the wireless client using 2.4GHz band is unable to connect to the wireless client with 5GHz band, and vice versa.</p> <p>For WLAN 2.4GHz and 5GHz set with the same SSID name:</p> <ul style="list-style-type: none"> <li>● No matter such function is enabled or disabled, clients using WLAN 2.4GHz and 5GHz can communicate for each other if Isolate Member (in Wireless LAN&gt;&gt;General Setup) is NOT enabled for such SSID.</li> <li>● Yet, if the function of Isolate Member (in Wireless LAN&gt;&gt;General Setup) is enabled for such SSID, clients using WLAN 2.4GHz and 5GHz will be unable to communicate with each other.</li> </ul>

After finishing all the settings here, please click OK to save the configuration.

### III-1-8 Station Control

Station Control is used to specify the duration that the wireless client can connect to the Vigor router. If this function is disabled, wireless clients can connect to the router as long as the router is powered on and the wireless feature is enabled.

This feature is especially useful for free WiFi service. For example, a coffee shop may offer free Wi-Fi service to its guests for one hour every day. In this scenario, the connection time can be set to “1 hour” and reconnection time set to “1 day”. In this way, every guest can surf the net for at most one hour, thus freeing up resources for other guests.

Wireless LAN(2.4GHz) >> Station Control

SSID 1	SSID 2	SSID 3	SSID 4
SSID		DrayTek	
Enable		<input type="checkbox"/>	
Connection Time		1 hour ▼	
Reconnection Time		1 day ▼	
<a href="#">Display All Station Control List</a>			
<a href="#">Hotspot Web Portal</a>			

**Note:**

Once the feature is enabled, the connection time quota will apply to each wireless client (identified by MAC address).

OK Cancel

Available settings are explained as follows:

Item	Description
SSID	Display the selected SSID.
Enable	Select to enable station control function for this SSID.
Connection Time / Reconnection Time	In the Connection Time dropdown box, select the maximum amount of time that a wireless client is allowed to connect within the period of time selected in the Reconnection Time dropdown box. Select User defined to manually enter the time in days, hours and minutes.
Display All Station Control List	Click to display all wireless clients that are under Station Control.
Hotspot Web Portal	Click to jump to the Hotspot Web Portal page.

To save changes on this page, select OK; to discard changes, select Cancel.



## III-1-9 Bandwidth Management

The downstream or upstream from FTP, HTTP or some P2P applications will occupy large of bandwidth and affect the applications for other programs. Please use Bandwidth Management to make the bandwidth usage more efficient.

Wireless LAN(2.4GHz) >> Bandwidth Management

SSID 1	SSID 2	SSID 3	SSID 4
SSID:		DrayTek	
Enable		<input checked="" type="checkbox"/>	
Bandwidth Limit Type		Auto Adjustment ▾	
Total Upload Limit(Kbps)		<input type="text" value="30000"/>	
Total Download Limit(Kbps)		<input type="text" value="30000"/>	

**Note:**

1. Download: Traffic going to any station.Upload: Traffic being sent from a wireless station.
2. Allow auto adjustment could make the best utilization of available bandwidth.

Available settings are explained as follows:

Item	Description
SSID	Display the specific SSID name.
Enable	Check this box to enable the bandwidth management for clients.
Bandwidth Limit Type	Auto Adjustment - Bandwidth limit is determined by the system automatically. Per Station Limit - Bandwidth limit is determined according to the limitation of the wireless client.
Total Upload Limit	It is available when Auto Adjustment is selected. Type a value to define the maximum data traffic (uploading) for all of the wireless clients connecting to Vigor2927.
Total Download Limit	It is available when Auto Adjustment is selected. Type a value to define the maximum data client(stations) connecting to Vigor2927.
Upload Limit	It is available when Per Station Limit is selected. Type a value to define the maximum data traffic (uploading) for each wireless client connecting to Vigor2927.
Download Limit	It is available when Per Station Limit is selected Type a value to define the maximum data traffic (downloading) for each wireless client connecting to Vigor2927.

To save changes on this page, select OK; to discard changes, select Cancel.

### III-1-10 AP Discovery

Vigor router can scan all regulatory channels to find working APs in the neighborhood. The scanning result can be used to determine the most desirable channel to use, or to locate an AP for establishing a WDS link. Note that during the scanning process (about 5 seconds), no client is allowed to connect to the Vigor. Only APs operating on the same band as the Vigor can be discovered.

Click the Scan button to start the AP discovery process.

Wireless LAN(2.4GHz) >> Access Point Discovery

#### Access Point List

Index	BSSID	Channel	RSSI	SSID	Authentication
1	02:1D:AA:94:ED:E0	11	10%	DrayTek-LAN-B	Mixed (WPA+WPA2) / PSK
2	00:1D:AA:94:ED:E0	11	10%	DrayTek-LAN-A	Mixed (WPA+WPA2) / PSK
3	1A:49:BC:42:4B:B0	11	5%	VigorAP920c-1	WPA2 / PSK
4	00:1D:AA:80:06:C4	11	0%	DrayTek	WPA2 / PSK
5	14:49:BC:42:4B:B0	11	5%	VigorAP920c	WPA2 / PSK
6	14:49:BC:0C:59:E4	11	10%	Vigor2865-PQC-Tang -2	None
7	14:49:BC:0C:59:E2	11	10%	Vigor2865-PQC-Tang -1	WPA2 / PSK
8	1E:49:BC:42:4B:B0	11	5%	VigorAP920c-2	WPA2 / PSK
9	00:1D:AA:80:06:B8	5	0%	910C RD8 Mickey	WPA / PSK

See [Statistics](#).

#### Note:

1. During the scanning process (~5 seconds), no station is allowed to connect with the router.
2. AP Discovery can only support up to 32 APs displayed on the screen.

Available settings are explained as follows:

Item	Description
Scan	Click to start the AP discovery process. The results will be shown on the box above this button.
Statistics	Shows channel usage by the neighboring APs. <div style="border: 1px solid black; padding: 5px; margin-top: 5px;"> <p style="font-size: small;">Wireless LAN &gt;&gt; Site Survey Statistics</p> <p style="font-size: x-small;">Recommended channels for usage: 1 2 3 4 5 6 7 8 9 10 11 12 13</p> <div style="text-align: center;"> <p style="font-size: x-small;">AP number v.s. Channel</p> <p style="font-size: x-small;">Channel</p> </div> <p style="text-align: center; margin-top: 5px;"><input type="button" value="Cancel"/></p> </div>
Add to WDS Settings	This field is available for WLAN (5GHz).
Add to	To establish a WDS link to an AP that was found in an AP scan, click its entry in the Access Point List window, and its MAC address will be copied to the AP's MAC address field. Select the WDS mode you wish to use and click Add to. The AP will be configured in Wireless LAN >> WDS Settings.

### III-1-11 Airtime Fairness

Airtime fairness is essential in wireless networks that must support critical enterprise applications.

Most of the applications are either symmetric or require more downlink than uplink capacity; telephony and email send the same amount of data in each direction, while video streaming and web surfing involve more traffic sent from access points to clients than the other way around. This is essential for ensuring predictable performance and quality-of-service, as well as allowing 802.11n and legacy clients to coexist on the same network. Without airtime fairness, offices using mixed mode networks risk having legacy clients slow down the entire network or letting the fastest client(s) crowd out other users.

With airtime fairness, every client at a given quality-of-service level has equal access to the network's airtime.

The wireless channel can be accessed by only one wireless station at the same time.

The principle behind the IEEE802.11 channel access mechanisms is that each station has *equal probability* to access the channel. When wireless stations have similar data rate, this principle leads to a fair result. In this case, stations get similar channel access time which is called airtime.

However, when stations have various data rate (e.g., 11g, 11n), the result is not fair. The slow stations (11g) work in their slow data rate and occupy too much airtime, whereas the fast stations (11n) become much slower.

Take the following figure as an example, there are 2 wireless stations on the wireless network, Station A (11g) and Station B (11n), both of which transmit data packets to the Vigor router. Even though they have equal opportunity to access the wireless channel, Station B (11n) gets only a little airtime and waits too much because Station A (11g) takes longer to send one packet. In other words, transmission from Station B (fast rate) is effectively being throttled by Station A (slow rate).

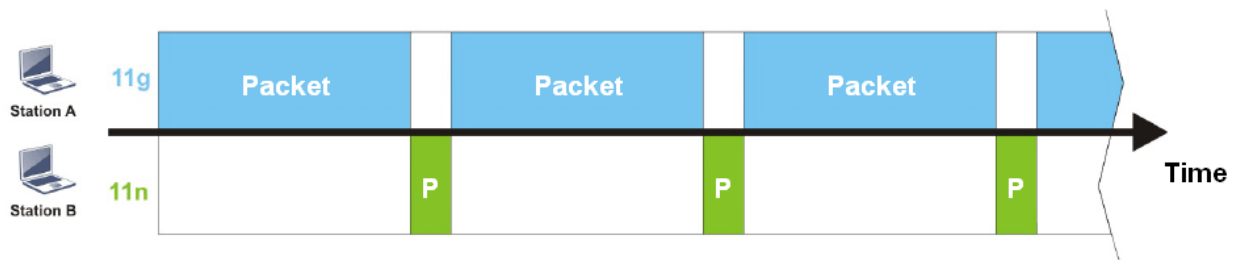

To alleviate this problem, Airtime Fairness tries to assign *similar airtime* to each station (A and B) by controlling TX traffic. In the following figure, Station B (11n) has higher opportunities to send data packets than Station A (11g). In this way, Station B (fast rate) gets its fair share of airtime and its speed is not limited by Station A (slow rate).



This is similar to automatic Bandwidth Limit, where the dynamic bandwidth limit of each station depends on instant active station number and airtime assignment. Please note that Airtime Fairness of 2.4 GHz and 5 GHz bands are independent, but stations connected to different SSIDs on the same band are prioritized as a group, because they all use the same wireless channel. Under certain environments, this function can reduce the adverse effects of slow wireless devices and improve the overall wireless performance.

Environments that can benefit by applying airtime fairness:

- (1) Many wireless stations.
- (2) All stations mainly use download traffic.
- (3) The performance bottleneck is wireless connection.

**Wireless LAN(2.4GHz) >> Airtime Fairness**

Enable **Airtime Fairness**  
 Triggering Client Number  (2 ~ 64) (Default: 2)

**Note:**  
 Please enable or disable this function according to the real situation and user experience. It is NOT suitable for all environments.

Available settings are explained as follows:

Item	Description
Enable Airtime Fairness	<p>Try to assign similar airtime to each wireless station by controlling TX traffic.</p> <p><b>Airtime Fairness</b> - Click the link to display the following explanation of airtime fairness note.</p>  <p><b>Triggering Client Number</b> - Airtime Fairness function is applied only when there are at least this many active wireless stations.</p>

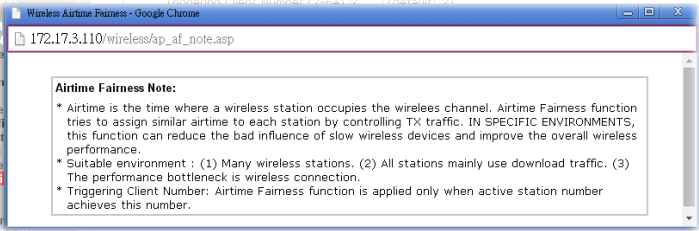
To save changes on this page, select OK; to discard changes, select Cancel.



**Info**

Airtime Fairness function and Bandwidth Limit function should be mutually exclusive. So their webs have extra actions to ensure these two functions are not enabled simultaneously.

---

### III-1-12 Band Steering (2.4 GHz)

Band Steering detects if the wireless clients are capable of 5GHz operation, and steers them to that frequency. It helps to keep the 2.4 GHz band clear for legacy clients, and improves users' experience by reducing 2.4 GHz channel utilization.

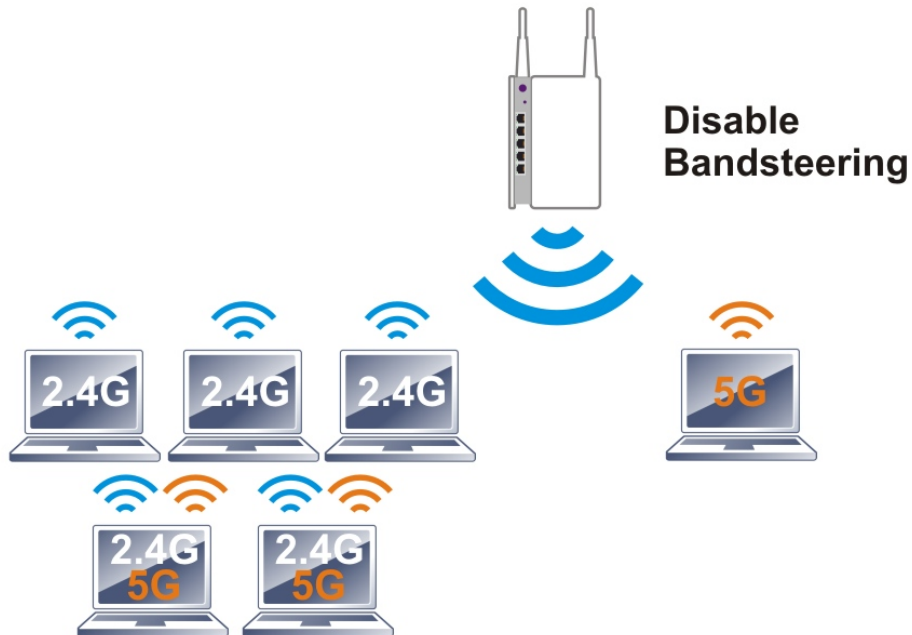

If a dual-band client is detected, the AP will let the wireless client connect to the less congested wireless band, such as the 5GHz band, to reduce network congestion.

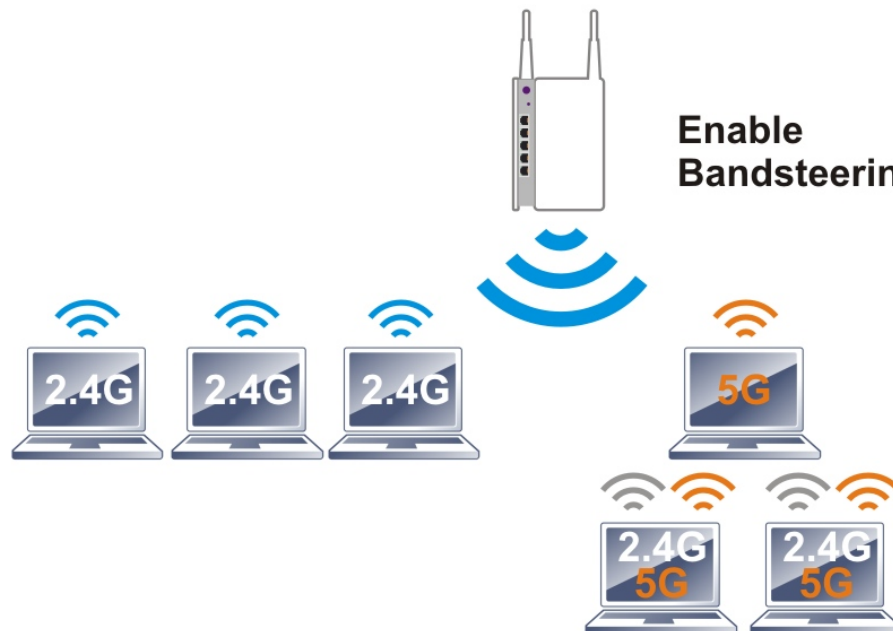

#### Info

For Band Steering to work properly, the same SSID and security settings must be configured on both 2.4 GHz and 5 GHz bands.

---

To configure Band Steering, go to the Wireless LAN (2.4GHz)>>Band Steering page:

Wireless LAN(2.4GHz) >> Band Steering

<input type="checkbox"/> Enable <b>Band Steering</b> Check Time for WLAN Client 5G Capability <input type="text" value="15"/> second(s) (1 ~ 60) (Default: 15)
---

**Note:**

Please setup at least one pair of 2.4GHz and 5GHz Wireless LAN with the same SSID and security.

Available settings are explained as follows:

Item	Description
Enable Band Steering	When enabled, the router will detect if wireless clients are capable of dual-band or not within the time limit. Check Time.... - When a wireless client attempts to connect, the router will block attempts to connect to the 2.4 GHz band for the specified period of time (default is 30 seconds), which hopefully will entice the client to connect to the 5 GHz band. If the client fails to connect to the 5 GHz band within the specified interval, it will then be able to connect to the 2.4 GHz band.

To save changes on this page, select OK; to discard changes, select Cancel.

The following diagram shows how Band Steering works.

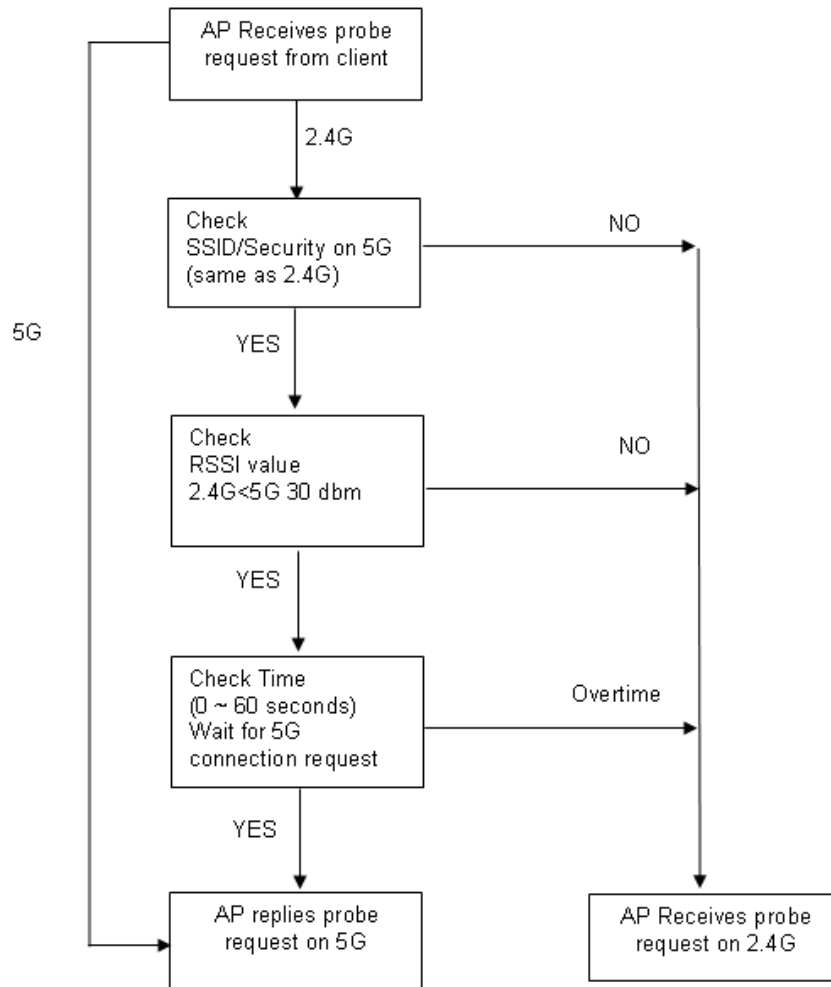

### Example: How to Use Band Steering?

1. Open Wireless LAN(2.4GHz)>>Band Steering.
2. Check the box of Enable Band Steering and use the default value (15) for check time setting.

#### Wireless LAN(2.4GHz) >> Band Steering

<input checked="" type="checkbox"/> Enable <b>Band Steering</b> Check Time for WLAN Client 5G Capability <input type="text" value="15"/> second(s) (1 ~ 60) (Default: 15)
--

**Note:**

Please setup at least one pair of 2.4GHz and 5GHz Wireless LAN with the same SSID and security.

3. Click OK to save the settings.
4. Open Wireless LAN (2.4GHz)>>General Setup and Wireless LAN (5GHz)>> General Setup. Configure SSID as *DrayTek2927\_BandSteering* for both pages. Click OK to save the settings.

Wireless LAN (2.4 GHz) >> General Setup

General Setting ( IEEE 802.11 )

Enable Wireless LAN

Radio

Mode:

Channel:

SSID

Index	Enable	Active	SSID	Hide SSID	Isolate Member	Isolate VPN	Mesh Sync VLAN ID
1	<input checked="" type="checkbox"/>	<input checked="" type="checkbox"/>	<input type="text" value="DrayTek2927_BandSteering"/>	<input type="checkbox"/>	<input type="checkbox"/>	<input type="checkbox"/>	0
2	<input type="checkbox"/>	<input type="checkbox"/>	<input type="text" value="DrayTek_Guest"/>	<input type="checkbox"/>	<input type="checkbox"/>	<input type="checkbox"/>	0
3	<input type="checkbox"/>	-	<input type="text" value="Max: 31 characters"/>	<input type="checkbox"/>	<input type="checkbox"/>	<input type="checkbox"/>	0
4	<input type="checkbox"/>	-	<input type="text" value="Max: 31 characters"/>	<input type="checkbox"/>	<input type="checkbox"/>	<input type="checkbox"/>	0

Schedule

Same settings for 2.4GHz and 5GHz

Wireless LAN (5 GHz) >> General Setup

General Setting ( IEEE 802.11 )

Enable Wireless LAN

Radio

Mode:

Channel:

SSID

Index	Enable	Active	SSID	Hide SSID	Isolate Member	Isolate VPN	Mesh Sync VLAN ID
1	<input checked="" type="checkbox"/>	<input checked="" type="checkbox"/>	<input type="text" value="DrayTek2927_BandSteering"/>	<input type="checkbox"/>	<input type="checkbox"/>	<input type="checkbox"/>	0
2	<input type="checkbox"/>	-	<input type="text" value="DrayTek_5G_Guest"/>	<input type="checkbox"/>	<input type="checkbox"/>	<input type="checkbox"/>	0

5. Open Wireless LAN (2.4GHz)>>Security and Wireless LAN (5GHz)>>Security. Configure Security as 12345678 for both pages. Click OK to save the settings.

Wireless LAN(2.4GHz) >> Security Settings

SSID 1	SSID 2	SSID 3	SSID 4
SSID	<input type="text" value="DrayTek2927_BandSteering"/>		
Mode:	<input type="text" value="Mixed(WPA+WPA2)/PSK"/>		
WPA			
Encryption Mode:	<input type="text" value="TKIP for WPA/AES for WPA2"/>		
Pre-Shared Key(PSK):	<input type="text" value="....."/>		
Password Strength:	<input type="text" value="Weak"/> <input type="text" value="Medium"/> <input type="text" value="Strong"/>		
EAPOL Key Retry:	<input checked="" type="radio"/> Enable <input type="radio"/> Disable		
Note:	Type 8~63 ASCII characters, for example: "cfqs01a2...".		

Same value for 2.4GHz and 5GHz

Wireless LAN (5 GHz) >> Security Settings

SSID 1	SSID 2	SSID 3	SSID 4
SSID	<input type="text" value="DrayTek2927_BandSteering"/>		
Mode:	<input type="text" value="Mixed(WPA+WPA2)/PSK"/>		
WPA			
Encryption Mode:	<input type="text" value="TKIP for WPA/AES for WPA2 and WPA3"/>		
Pre-Shared Key(PSK):	<input type="text" value="....."/>		
Password Strength:	<input type="text" value="Weak"/> <input type="text" value="Medium"/> <input type="text" value="Strong"/>		
EAPOL Key Retry:	<input checked="" type="radio"/> Enable <input type="radio"/> Disable		
Note:	Type 8~63 ASCII characters, for example: "cfqs01a2...". For strong passwords:		

6. The Vigor will now steer wireless clients to the less congested wireless band, such as 5GHz to reduce network congestion.



### III-1-13 Roaming

WiFi roaming allows wireless stations to switch connections between access points within an area to achieve better coverage and signal quality. It usually is up to the wireless station to switch to another access point with stronger signal strength while it is already connected, but Vigor wireless routers have an AP-assisted client roaming feature that could facilitate roaming on wireless stations. Depending on the roaming configuration, the Vigor monitors the Received Signal Strength Indicator (RSSI) of wireless stations and disconnect stations whose RSSI falls below a certain (configurable) threshold, thus forcing stations to seek out other WiFi hosts to connect to.

To configure wireless roaming settings, go to Wireless LAN >> Roaming.

Wireless LAN(2.4GHz) >> Roaming

#### Router-assisted Client Roaming Parameters

Disable RSSI Requirement

Strictly Minimum RSSI      -73 dBm ( 42 %) (Default: -73)

Minimum RSSI      -66 dBm ( 60 %) (Default: -66)

with Adjacent AP RSSI over      5 dB (Default: 5)

Available settings are explained as follows:

Item	Description
Disable RSSI Requirement	The Vigor router does not pay attention to the RSSI level of wireless stations. Selecting this option means the Vigor router will not interfere with the roaming behavior of wireless stations.
Strictly Minimum RSSI	The Vigor router will immediately disconnect the wireless station if its RSSI falls below the configured value.
Minimum RSSI	<p>Minimum RSSI - The Vigor router will disconnect wireless clients whose RSSI falls below the minimum threshold only if there is also a neighboring wireless host (router or AP) that has an RSSI value (defined in the field of With Adjacent AP RSSI over) higher than a certain threshold.</p> <p>In order for this option to work, other wireless hosts connected to the same LAN subnet need to support the exchange of RSSI information with peer wireless hosts via Ethernet.</p> <p>With Adjacent AP RSSI over - Specify a value as a threshold.</p>

To save changes on this page, select OK; to discard changes, select Cancel.

## III-1-14 Station List

Station List provides an overview of all currently connected wireless clients and their status. As an added convenience, you may choose to add a particular wireless client to the Access Control by double clicking its entry in the list to populate the MAC address field, followed by clicking the Add button.

There are 3 tabs on the Station List screen: General, Advanced and Neighbor. Both General and Advanced show wireless stations connected to the Vigor router, whereas Neighbor shows nearby wireless stations connected to other access points that are detected by the Vigor router.

Wireless LAN (2.4 GHz) >> Station List

Station List

General    Advanced    Neighbor

Index	Status	IP Address	MAC Address	SSID
-------	--------	------------	-------------	------

Refresh

**Status Codes :**  
C:Connected, No encryption.  
E:Connected, WEP.  
P:Connected, WPA.  
A:Connected, WPA2.  
S:Connected, WPA3.  
O:Connected, OWE.  
B:Blocked by Access Control.  
N:Connecting.  
F:Fail to pass WPA/PSK authentication.

**Add to Access Control :**

Client's MAC address    FF:FF:FF:FF:FF:FF

**Note:**

After a station connects to the router successfully, it may be turned off without notice. In that case, it will still be on the list until the connection expires.

Add

Available settings are explained as follows:

Item	Description
Refresh	Click to refresh the station list.
Add	Click to add the address in the Client's MAC address field to Access Control.

Below shows the Advanced tab, which lists the same clients as the General tab, but with more detailed information.

Wireless LAN (2.4 GHz) >> Station List

Station List

										General	Advanced	Neighbor
Index	MAC Address	AID	RSSI	Rate	BW	PSM	WMM	PhMd	MCS			
Refresh												
<b>Add to <u>Access Control</u> :</b>												
Client's MAC address										FF:FF:FF:FF:FF:FF		

**Note:**

After a station connects to the router successfully, it may be turned off without notice. In that case, it will still be on the list until the connection expires.

Add

Below shows the Neighbor tab, which lists wireless clients seen by the router but are not connected to the router's built-in access point.

Wireless LAN (2.4 GHz) >> Station List

Station List

							General	Advanced	Neighbor
Index	MAC Address	Vendor	RSSI	Approx. Distance	SSID	Visit Time			
1	02:00:00:00:00:00		29% (-78dBm)	44.67m	none	0d:0h:4m:56s			
2	5A:DF:43:39:5B:B4	Raspberr	26% (-79dBm)	50.12m	none	0d:0h:0m:0s			
3	B8:27:EB:CD:7C:D0		1% (-94dBm)	281.84m	none	0d:0h:6m:0s			
4	AE:5B:D2:DC:F9:1F		1% (-99dBm)	501.19m	none	0d:0h:0m:0s			
5	5A:F8:3F:C4:F2:8B		1% (-94dBm)	281.84m	none	0d:0h:0m:0s			
6	F2:02:B8:72:3E:21		1% (-99dBm)	501.19m	none	0d:0h:0m:0s			
7	86:91:01:D6:D7:30		0% (-90dBm)	177.83m	none	0d:0h:0m:0s			
8	CE:69:2F:E9:2C:7E		1% (-91dBm)	199.53m	none	0d:0h:0m:0s			
9	B6:16:25:F8:48:0F		1% (-99dBm)	501.19m	none	0d:0h:0m:0s			
10	3A:61:A8:DE:13:04		1% (-99dBm)	501.19m	none	0d:0h:0m:0s			
Refresh									
<b>Add to <u>Access Control</u> :</b>									
Client's MAC address							FF:FF:FF:FF:FF:FF		

**Note:**

1. Approx. Distance is calculated by actual signal strength of device detected. Inaccuracy might occur based on barrier encountered.
2. Due to the differences in signal strength for different devices, the calculated value of approximate distance also might be different.
3. Trademarks and brand names are the properties of their respective owners.

Add

## III-2 Mesh Network

Vigor router plays a role of Mesh root in a VigorMesh network. To configure the mesh network, please use the Mesh Wizard or open the Mesh menu to configure detailed settings.

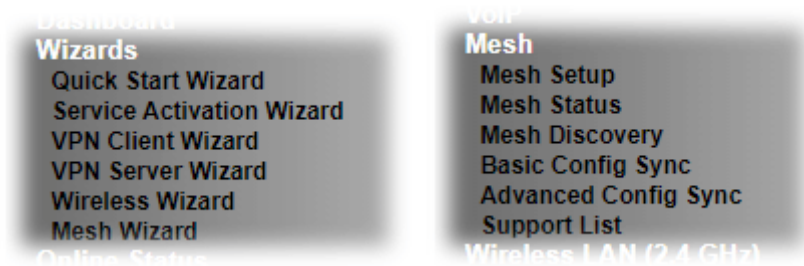

Please note that, within VigorMesh network,

- the total number allowed for mesh nodes is 8 (including the mesh root)
- the maximum number of hop is 3

Refer to the following figure:

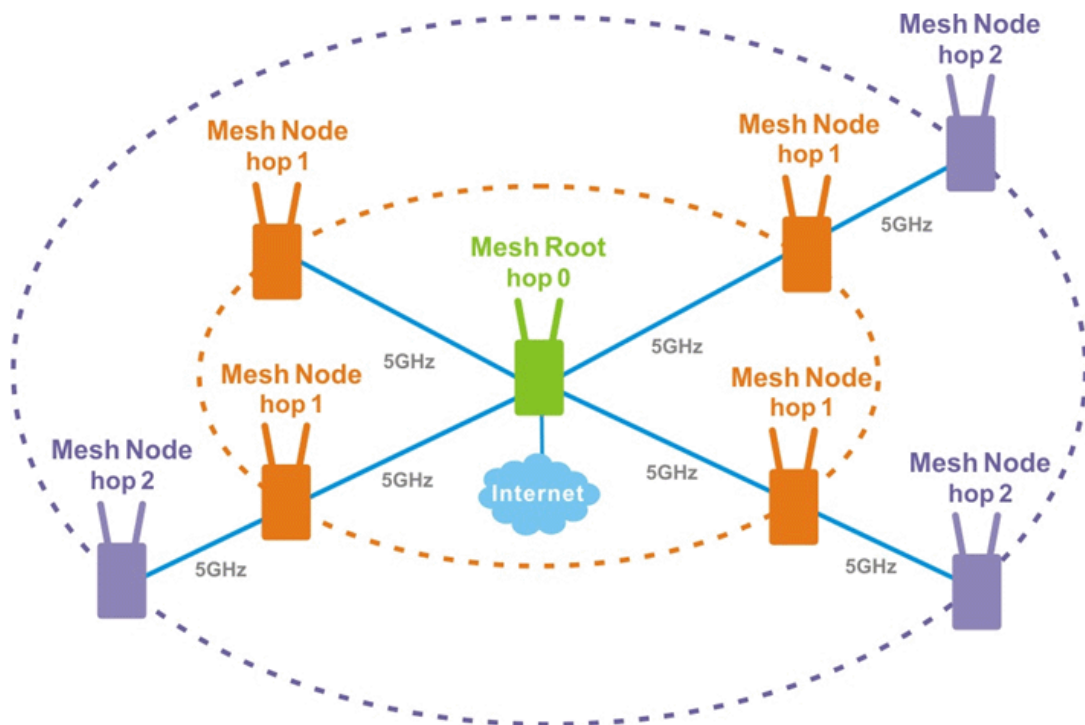

For the mesh group set within VigorMesh network,

- It must be composed by "1" Mesh Root and "0~7" mesh nodes
- (Roaming) Normally members in a mesh group use the same Wireless SSID/security
- (Add) Only the mesh root can add a new mesh node into the mesh group
- (Recover) A disconnected mesh node will automatically try to connect to another connected mesh node of the same group

## Mesh Root

Mesh Root indicates that Vigor router would be other AP's uplink connection. As a Mesh Root, Vigor router must connect to internet through WANs to have an internet connection.

The following figure shows how Vigor router runs as MESH ROOT:

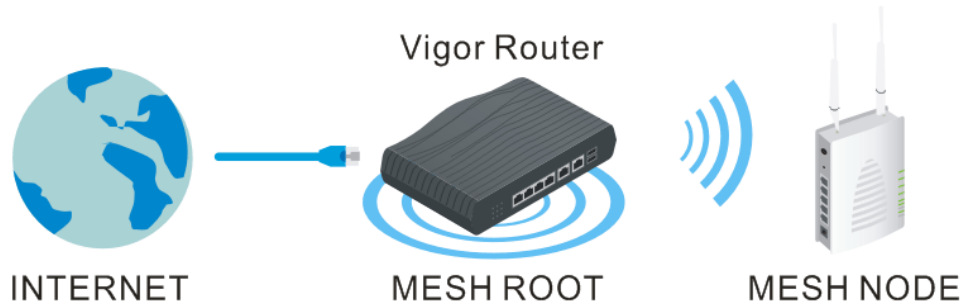

---

## III-2-1 Mesh Wizard

Mesh wizard offers a quick way to configure mesh network.

1. Go to Wizards>Mesh Wizard.

### Mesh Wizard

#### Mesh Setup

Enable Mesh

Role:

Group Name:

< Back   Next >   Finish   Cancel

2. Check the Enable Mesh box. Click Next to get the following page.

Mesh Wizard

Wifi Setup

**Wifi Settings**  
Wifi Name:   
Wifi Password:

Enable Guest Wifi  
Guest Wifi Name:   
Guest Wifi Password:

**Note:**  
The WiFi settings will apply to all Wireless bands.

3. Set the Wifi Name and password; click Next to get the following page.

Mesh Wizard

Enter login password

Please enter an alpha-numeric string as your **Password**.

Old Password   
New Password   
Confirm Password

**Hint:** If you want to keep the password unchanged, leave the password blank and press "Finish" button to skip this process.

4. Set the password, if required. Then, click Finish. The system starts to search available APs.

Mesh Wizard

Mesh Node Setup

Setup additional VigorAPs to Mesh network?  
Please power up and wait for us to find it.

**Search List**

19%

5. Wait for a few minutes. Later, APs around Vigor router will be shown below.

**Mesh Wizard**

---

**Mesh Node Setup**

Setup additional VigorAPs to Mesh network?  
Please power up and wait for us to find it.

**Search List**

Select	Model	MAC	Device Name
<input checked="" type="checkbox"/>	VigorAP903	00:50:7F:F1:91:BC	<input type="text" value="AP903"/>

6. Select the one (e.g., VigorAP903 in this case) you want to group under Vigor router. Then, click Apply.

**Mesh Wizard**

---

**Mesh Node Setup**

Setup additional VigorAPs to Mesh network?  
Please power up and wait for us to find it.

**Search List**

4%

7. When the mesh node setup is finished, click Finish.

**Mesh Wizard**

---

**Mesh Node Setup Finished**

Setup Mesh Root and Mesh Node completed.

- After "Mesh Wizard Setup OK!" appears, go to Mesh>>Mesh Status. The mesh node (AP903) has been grouped under the Vigor router.

### Mesh Wizard

**Mesh Wizard Setup OK!**

#### Mesh >> Mesh Status

Local Status		<a href="#">Refresh</a>
Device Name	DrayTek	
MAC Address	14:49:BC:15:1F:00	
Model	Vigor2865	
Operation Mode	MeshRoot	
Wireless Downlink Band	Auto	
Group Name	VigorMesh	
Link Status	Connected	
Hop	0	
Downlink Number	1	
Downlink	00:50:7F:F1:7F:1D (VigorAP903)      Wireless 5GHz (Ch36) (-58dBm / 81%)	

Devices		Total Number of Clients: <b>36</b>							
Index	Status	Device Name	IP Address	MAC Address (Model)	Hop	Uplink	Uptime	Clients	Action
1	<span style="color: green;">●</span> Root	DrayTek	172.16.21.64	14:49:BC:15:1F:00 (Vigor2865)	0		3d 12:06:49	<b>14</b>	<a href="#">Reselect</a>
2	<span style="color: green;">●</span> Online	MK_AP903	172.16.21.58	00:50:7F:F1:91:BC (VigorAP903)	1	14:49:BC:17:70:08 Wireless 5GHz (Ch36) (-60dBm / 76%)	3d 12:05:44	<b>6</b>	<a href="#">Disconnect</a>

● Online(sync ready)   
 ● Online   
 ● Offline



## III-2-2 Mesh Setup

This page can modify settings related to Mesh. You can search and specify mesh nodes as members under current mesh group.

Mesh >> Mesh Setup

**General Setup**
| Refresh

Enable Mesh

Role	Mesh Root
Wireless Downlink Band	Dedicate 5GHz
Group Name	<input type="text" value="VigorMesh"/>
Auto Reselect	<input checked="" type="checkbox"/>
Log Level	<input type="text" value="Basic"/>

**Mesh Group**

Select	Index	Role	MAC Address	Model	CFG Sync	Device Name
	1	Root	14:49:BC:11:7B:60	Vigor2927		

Bridge VLAN to Mesh

### Add Mesh Node

Press Search button below to find and adopt the new node into Mesh Group.

**Search List**

Select	MAC Address	Model	Operation Mode	Device Name	RSSI

Backup Mesh Config: <input type="button" value="Backup"/>	Upload From File: <input type="button" value="選擇檔案"/> 未選擇任何檔案	<input type="button" value="Restore"/>
---	---	--

**Note:**

After enabling the Mesh function, all the settings on Wireless LAN (5 GHz)>>WDS will be invalid.

Available settings are explained as follows:

Item	Description
<b>General Setup</b>	
Enable Mesh	Check to enable the mesh function.
Role	Displays the role of Vigor router. Vigor router is a mesh root to provide internet access for Mesh Network.
Wireless Downlink Band	At present, only 5GHz is dedicated as the downlink band for connecting with an uplinked mesh node.
Group Name	Displays the name of the current mesh group.
Auto Reselect	It is selected in default. To perform the auto reselect, make sure the process for CFG Sync and CFG Check for mesh nodes are successful. If enabled, after changing the environment of mesh network (e.g., offline, disconnection), the root device will perform auto reselect to reconstruct the mesh network.

Log Level	Choose Basic or Detailed. Related information will be shown on the <b>Diagnostics&gt;&gt;Syslog Explorer</b> .																					
Mesh Group	The basic information including role, MAC address, and model name of the mesh root and node (up to 8 entries, one mesh root and seven mesh nodes) will be shown on this field. Reset - Click it to clear the Mesh Group information. Delete - Click it to remove the selected entry.																					
Bridge VLAN to Mesh	Select to enable the function.																					
<b>Add Mesh Node - It is available only if the Mesh function is enabled.</b>																						
Search	<p>Click to scan available APs around this Vigor router.</p> <div data-bbox="711 618 1417 775"> <p><b>Add Mesh Node</b></p> <p>Press Search button below to find and adopt the new node into Mesh Group.</p> <p>Searching</p> <p>Search List</p> <p>22%</p> <p>Apply</p> </div> <div data-bbox="711 797 1417 831"> <p>Backup Mesh Config: <input type="button" value="Backup"/> Upload From File: <input type="button" value="選擇檔案"/> 未選擇任何檔案 <input type="button" value="Restore"/></p> </div> <p><b>Note:</b> After enabling the Mesh function, all the settings on Wireless LAN (5 GHz)&gt;&gt;WDS will be invalid.</p> <p>The detected APs will be shown on the Search List.</p> <div data-bbox="711 931 1417 1111"> <p><b>Add Mesh Node</b></p> <p>Press Search button below to find and adopt the new node into Mesh Group.</p> <p>Search</p> <p>Search List</p> <table border="1"> <thead> <tr> <th>Select</th> <th>MAC Address</th> <th>Model</th> <th>Operation Mode</th> <th>Device Name</th> </tr> </thead> <tbody> <tr> <td><input type="checkbox"/></td> <td>00:1D:AA:7C:F5:A4</td> <td>VigorAP1060C</td> <td>MeshNode(Wireless)</td> <td>AP1060C</td> </tr> </tbody> </table> <p>Apply</p> </div> <div data-bbox="711 1144 1417 1200"> <p>Backup Mesh Config: <input type="button" value="Backup"/> Upload From File: <input type="button" value="選擇檔案"/> 未選擇任何檔案 <input type="button" value="Restore"/></p> </div>	Select	MAC Address	Model	Operation Mode	Device Name	<input type="checkbox"/>	00:1D:AA:7C:F5:A4	VigorAP1060C	MeshNode(Wireless)	AP1060C											
Select	MAC Address	Model	Operation Mode	Device Name																		
<input type="checkbox"/>	00:1D:AA:7C:F5:A4	VigorAP1060C	MeshNode(Wireless)	AP1060C																		
Apply	<p>Select the mesh node you want and click this button. The new mesh node will be shown on Mesh Group.</p> <div data-bbox="711 1312 1382 1738"> <p>Mesh &gt;&gt; Mesh Setup</p> <p>General Setup <span style="float: right;">Refresh</span></p> <p><input checked="" type="checkbox"/> Enable Mesh</p> <p>Role: Mesh Root</p> <p>Wireless Downlink Band: Dedicate 5GHz</p> <p>Group Name: VigorMesh</p> <p>Auto Reselect: <input checked="" type="checkbox"/></p> <p>Log Level: Basic</p> <p><b>Mesh Group</b></p> <table border="1"> <thead> <tr> <th>Select</th> <th>Index</th> <th>Role</th> <th>MAC Address</th> <th>Model</th> <th>CFG Sync</th> <th>Device Name</th> </tr> </thead> <tbody> <tr> <td><input type="checkbox"/></td> <td>1</td> <td>Root</td> <td>14:49:BC:11:7B:60</td> <td>Vigor2927</td> <td></td> <td></td> </tr> <tr> <td><input type="checkbox"/></td> <td>2</td> <td>Node</td> <td>00:1D:AA:7C:F5:A4</td> <td>VigorAP1060C</td> <td>Ongoing</td> <td>AP1060C</td> </tr> </tbody> </table> <p><input type="button" value="Reset"/> <input type="button" value="Delete"/></p> <p><input type="checkbox"/> Bridge VLAN to Mesh</p> <p style="text-align: center;"><input type="button" value="OK"/> <input type="button" value="Cancel"/></p> </div>	Select	Index	Role	MAC Address	Model	CFG Sync	Device Name	<input type="checkbox"/>	1	Root	14:49:BC:11:7B:60	Vigor2927			<input type="checkbox"/>	2	Node	00:1D:AA:7C:F5:A4	VigorAP1060C	Ongoing	AP1060C
Select	Index	Role	MAC Address	Model	CFG Sync	Device Name																
<input type="checkbox"/>	1	Root	14:49:BC:11:7B:60	Vigor2927																		
<input type="checkbox"/>	2	Node	00:1D:AA:7C:F5:A4	VigorAP1060C	Ongoing	AP1060C																
Backup Mesh Config	Backup - Click the button to save the configuration as a file.																					
Select/Restore	Click the Upload button to specify a configuration file. Then click Restore to apply the configuration. When the MAC address of the Vigor router is not the mesh root of the mesh group, the restore operation will not succeed.																					

## III-2-3 Mesh Status

This page shows the mesh network status.

One Mesh Group can contain up to 8 devices. In the following figure, the device with hop 0 is one special Ethernet Backhaul. It means this node will use Ethernet cable to join the mesh group while others use the wireless link.

Mesh >> Mesh Status

Local Status		<a href="#">Refresh</a>	
Device Name	DrayTek		
MAC Address	14:49:BC:15:1F:00		
Model	Vigor2927		
Operation Mode	MeshRoot		
Wireless Downlink Band	Auto		
Group Name	VigorMesh		
Link Status	Connected		
Hop	0		
Downlink Number	1		
Downlink	00:50:7F:F1:7F:1D (VigorAP903)	Wireless 5GHz (Ch36) (-58dBm / 81%)	

Devices								Total Number of Clients: 36	
Index	Status	Device Name	IP Address	MAC Address (Model)	Hop	Uplink	Uptime	Clients	Action
1	Root	DrayTek	172.16.21.64	14:49:BC:15:1F:00 (Vigor2927)	0		3d 12:06:49	14	<a href="#">Reselect</a>
2	Online	MK_AP903	172.16.21.58	00:50:7F:F1:7F:1D (VigorAP903)	1	14:49:BC:17:70:08 Wireless 5GHz (Ch36) (-60dBm / 76%)	3d 12:05:44	6	<a href="#">Disconnect</a>
3	Online	HR_AP903	172.16.21.62	00:50:7F:67:29:0C (VigorAP903)	2	00:50:7F:F1:7F:1D Wireless 5GHz (Ch36) (-64dBm / 65%)	3d 12:05:22	10	<a href="#">Disconnect</a>
4	Online	TS_AP1000	172.16.21.57	00:1D:AA:04:F0:DC (VigorAP1000C)	3	00:50:7F:67:29:0C Wireless 5GHz (Ch36) (-68dBm / 55%)	3d 12:05:00	6	<a href="#">Disconnect</a>

● Online (sync ready)  
 ● Online  
 ● Offline

Available settings are explained as follows:

Item	Description
Local Status	Display general information for this device.
Devices	Display detailed information for this device (as mesh root) and mesh node(s) in the group. Index - Display the number of the device within a mesh group. Status - Display the role and connect status of the device. Device Name - Display the name of the device (for identification). IP Address - Display the IP address of the device. MAC Address - Display the MAC address of the device. Hop - Display the level of the device in Mesh Network. "0" means the device is connected to Internet by using Ethernet cable (wired). "1" to "3" means how many wireless links the device has to go through to reach a Hop 0 device. Uplink - Display the MAC address of the device that the AP connects to.
Total number of Clients	Display the station list of all mesh devices.

Station List of All Devices						
Index	MAC Address	Hostname	Vendor	SSID	Channel RSSI	TxRate(Kbps) RxRate(Kbps)
1	00:50:7F:F0:C9:72	TA001029	DrayTek	staffs_4F	6 68%(-63dBm)	0 0
2	00:50:7F:F0:D1:1D	ta002171	DrayTek	staffs_4F	6 41%(-73dBm)	0 0
3	5C:97:F3:D3:D5:F7	Tze-Pingde...	Apple	staffs_4F	6 100%(-49dBm)	0 0
4	40:98:AD:58:F2:52	Tyronetkil...	Apple	staffs	6 55%(-68dBm)	0 0
5	00:50:7F:37:6D:E5	N/A	DrayTek	staffs_4F	6 52%(-69dBm)	0 0
6	00:50:7F:37:67:BE	N/A	DrayTek	staffs_4F	6 55%(-68dBm)	0 0
7	30:F7:C5:1D:3D:11	N/A	Apple	guests	6 83%(-57dBm)	30 12
8	40:F0:2F:22:EB:A0	N/A	LiteonTe	staffs	6 34%(-76dBm)	22 4
9	18:65:90:DE:D4:E5	N/A	Apple	staffs_4F	6 100%(-44dBm)	0 0
10	60:45:CB:57:1F:36	N/A	N/A	staffs_4F	6 15%(-84dBm)	0 0
11	AC:3F:3E:62:E6:0D	N/A	Samsung	staffs_4F	6 81%(-58dBm)	0 0
12	50:8C:96:E0:00:11	N/A	Apple	staffs	6 71%(-62dBm)	0 0
13	04:B1:67:52:48:90	Redmi5-mys...	N/A	staffs_4F	6 45%(-72dBm)	0 0
14	04:C2:3E:3F:CB:F8	android-ac...	HTC	staffs_4F	6 55%(-68dBm)	0 0
15	0C:8B:FD:31:0B:78	N/A	Intel	staffs_4F	6 89%(-55dBm)	2 2
16	58:48:22:EB:F8:62	android-5f...	Sony	staffs	6 55%(-68dBm)	0 0
17	CC:9F:7A:63:11:27	N/A	N/A	staffs_4F5...	36 52%(-69dBm)	0 0
18	20:47:DA:58:17:79	RedmiNote5...	N/A	staffs_4F5...	36 50%(-70dBm)	0 0
19	70:81:EB:65:80:E5	cheng	Apple	staffs_4F5...	36 87%(-56dBm)	0 0
20	8C:85:90:64:FE:A4	N/A	Apple	staffs_4F5...	36 36%(-75dBm)	0 0

### III-2-4 Mesh Discovery

Before a Mesh Node is connected, it is unable to check the device status from Mesh Root. This page can help to discover all Mesh devices around and offer the Link Status and Operation Mode of each Mesh device.

For obtaining the list of devices around this Vigor router, click Scan. Later, surrounding Mesh device(s) will be displayed on this page.

**Mesh >> Mesh Discovery**

#### Device list

Index	MAC Address	Model	Operation Mode	Link Status	RSSI
1	14:49:BC:0A:8A:B8	Vigor2135	MeshRoot	Connected	-61dBm(good)
2	14:49:BC:02:37:40	Vigor2927ax	MeshRoot	Connected	-88dBm(weak)
3	00:1D:AA:04:F0:6C	VigorAP1000C	AP	Connected	-80dBm(fair)
4	00:1D:AA:80:FE:D4	VigorAP1060C	MeshRoot	Connected	-80dBm(fair)
5	14:49:BC:42:4B:B0	VigorAP920C	MeshNode(Wireless)	Connected	-59dBm(good)
6	14:49:BC:42:4B:94	VigorAP920C	MeshRoot	Connected	-60dBm(good)
7	00:1D:AA:62:0F:A8	Vigor2862	MeshRoot	Connected	-67dBm(good)
8	00:50:7F:F1:7F:1D	VigorAP903	MeshNode(Wireless)	Connected	-58dBm(good)
9	14:49:BC:42:6E:1E	VigorAP960C	MeshNode(Wireless)	New	-59dBm(good)
10	00:1D:AA:7C:F5:BC	VigorAP1060C	MeshNode(Wireless)	Disconnected	-85dBm(weak)
11	00:1D:AA:3F:4F:86	VigorAP912C	AP	Connected	-69dBm(good)

Scan

**Note:**

During the scanning process (about 10 seconds), no station is allowed to connect with the Router and Mesh Network may disconnect.

Only the device with the Link Status of "New" can be selected and grouped under this router.

## III-2-5 Basic/Advanced Config Sync

If you add one Mesh Node in a mesh group, the Mesh Root will send the basic configuration to the device. This page could help you to change the Mesh Root settings and deliver the new configuration of the Mesh Root to all "connected" Mesh Nodes.

### Mesh >> Basic Configuration Sync

#### System Maintenance

Index	Name	Value
1	X_00507F_System.Management.SkipQuickStartWizard	Enable
2	X_00507F_System.TR069Setting.CPEEnable	0
3	ManagementServer.URL	
4	ManagementServer.Username	
5	ManagementServer.Password	*****
6	ManagementServer.ConnectionRequestUsername	vigor
7	ManagementServer.ConnectionRequestPassword	*****
8	X_00507F_System.AdminmodePassword.Admin	admin
9	X_00507F_System.AdminmodePassword.Password	*****
10	X_00507F_System.SyslogMail.SysLogAccess.SysLogEnable	0
11	X_00507F_System.SyslogMail.SysLogAccess.LogServerIP	
12	X_00507F_System.SyslogMail.SysLogAccess.LogServerPort	514
13	X_00507F_System.SyslogMail.MailAlert.MailAlertEnable	0
14	X_00507F_System.SyslogMail.MailAlert.SMTPServer	
15	X_00507F_System.SyslogMail.MailAlert.MailTo	
16	X_00507F_System.SyslogMail.MailAlert.Username	
17	X_00507F_System.SyslogMail.MailAlert.Password	*****
18	X_00507F_System.SyslogMail.MailAlert.UseTLS	0
19	X_00507F_System.SyslogMail.MailAlert.SMTPServerPort	25
20	X_00507F_System.PasswordEncryption.AdminPassword	*****
21	X_00507F_System.PasswordEncryption.AdminSalt	*****

#### Wireless LAN (2.4GHz)

Index	Name	Value
1	X_00507F_WirelessLAN_AP.General.EnableWLAN	1
2	X_00507F_WirelessLAN_AP.General.SSID.1.ESSID	DrayTek

Available settings are explained as follows:

Item	Description
System Maintenance / Wireless LAN (2.4Hz) / Wireless LAN (5GHz)	Check the item(s) you want to make configuration sync.
Sync	This button is available only when any mesh node in the mesh network is online and ready to sync. Click it to apply the settings configured by this router to all connected mesh node.

#### Tips for Mesh network setup

- Set up TWO mesh devices with uplink RSSI larger than -65dBm.
- Upgrade the firmware version of Mesh devices through Mesh link, starting from the mesh device with less hop number. For example, upgrade the firmware from the root, hop1 Mesh Node then hop2 Mesh Node, and so on.

- VigorMesh network supports up to 3 hops of mesh devices. However, it is suggested to connect the mesh group with less than or equals to 2 hops.  
For your reference, we make a real mesh environment test and get the following record. (Use VigorAP APP to do internet speed test with different hops mesh node.)  
Internet Download Speed (for root and hop1 ~ hop3):  
iPad connects to Root : 80Mbps  
iPad connects to hop1 Node : 49Mbps (Uplink RSSI : -55dBm)  
iPad connects to hop2 Node : 41Mbps (Uplink RSSI : hop2 -64dBm / hop1 -55dBm)  
iPad connects to hop3 Node : 26Mbps (Uplink RSSI : hop3 -62dBm / hop2 -68dBm / hop1 -55dBm)
- It is not suggested to use a wireless Mesh Node with Ethernet cable connected to a Mesh Root.
- If resetting a Mesh Root,
  - All "connected" Mesh Nodes will be informed to reset.
  - Group List and Group Key will be reset, too.
  - For those Mesh Nodes unable to reset, reset them manually. Reset the Group List by web or factory default.
- If resetting a Mesh Node,
  - Group List and Group Key will be cleared.
  - Link Status will become "New".
- If Mesh Search / Apply / Discover is worked too fast or is done with empty result, your request may be rejected. Please try again.
- Troubleshooting:
  - Check the firmware version. Please make sure all APs within the mesh group are in the newest firmware version.
  - Check the OP (operation) Mode. Make sure new Mesh Node doesn't accidentally get DHCP IP and becomes AP mode.
  - Check the country code and channels. For example, it is impossible for connecting a VigorAP 912C Mesh Root with 5G channel 36 to VigorAP920R Wireless Mesh Node in EU country code.
  - Check the channel load. Make sure it is not over 70%.

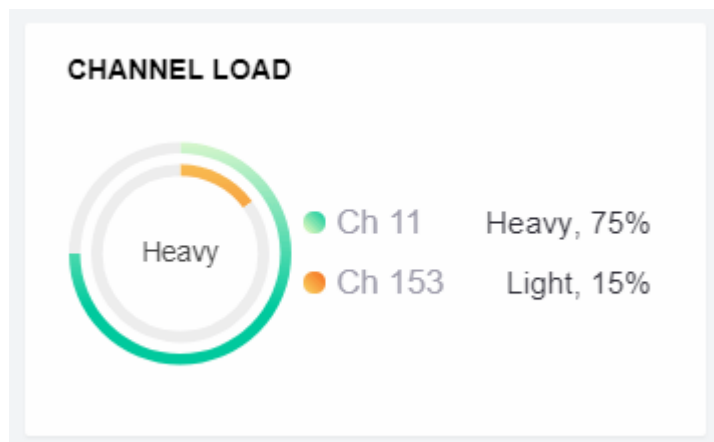

- Collect some Mesh logs and send the result to DrayTek for analyzing.

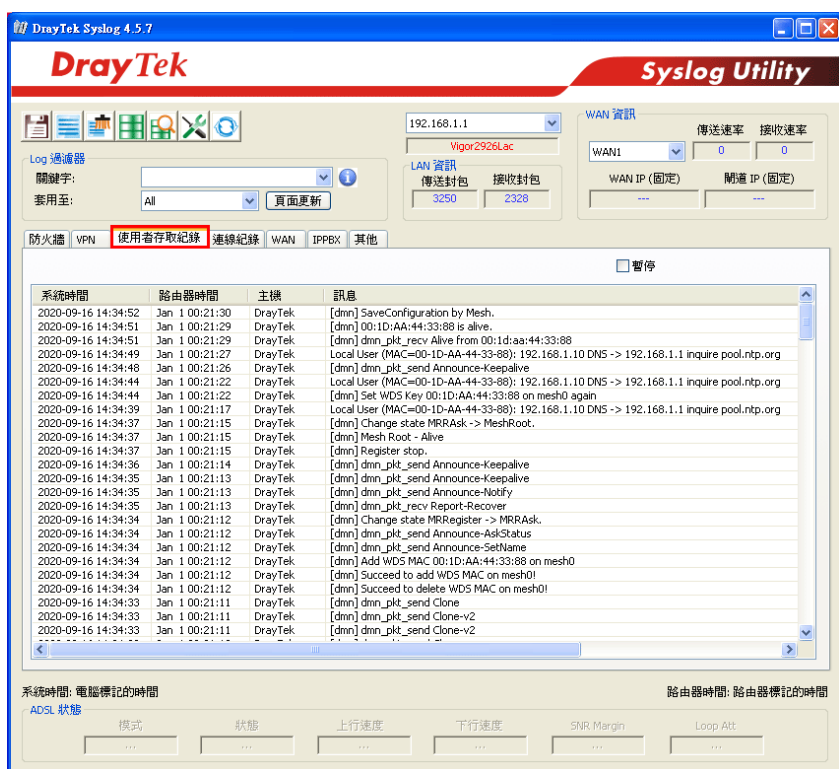

## III-2-6 Support List

### Mesh >> Support List

The following compatibility test lists DrayTek AP models supported by Vigor router Mesh.

Model	Status	Firmware Version
VigorAP 802	Y	1.3.6
VigorAP 903	Y	1.3.8
VigorAP 912C	Y	1.3.6
VigorAP 1000C	Y	1.3.5
VigorAP 960C	Y	1.4.0
VigorAP 1060C	Y	1.4.2

Y:Tested and is supported.

N:Not supported.

This page is left blank.



# Part IV VoIP



VoIP

Voice over IP network (VoIP) enables you to use your broadband Internet connection to make toll quality voice calls over the Internet.

---

## IV-1 VoIP

Voice over IP network (VoIP) enables you to use your broadband Internet connection to make toll quality voice calls over the Internet.



Info

---

This function is used for “V” models.

---

There are many different call signaling protocols, methods by which VoIP devices can talk to each other. The most popular protocols are SIP, MGCP, Megaco and H.323. These protocols are not all compatible with each other (except via a soft-switch server).

The Vigor V models support the SIP protocol as this is an ideal and convenient deployment for the ITSP (Internet Telephony Service Provider) and softphone and is widely supported. SIP is an end-to-end, signaling protocol that establishes user presence and mobility in VoIP structure. Every one who wants to talk using his/her SIP Uniform Resource Identifier, “SIP Address”. The standard format of SIP URI is

`sip: user:password @ host: port`

Some fields may be optional in different use. In general, “host” refers to a domain. The “userinfo” includes the user field, the password field and the @ sign following them. This is very similar to a URL so some may call it “SIP URL”. SIP supports peer-to-peer direct calling and also calling via a SIP proxy server (a role similar to the gatekeeper in H.323 networks), while the MGCP protocol uses client-server architecture, the calling scenario being very similar to the current PSTN network.

After a call is setup, the voice streams transmit via RTP (Real-Time Transport Protocol). Different codecs (methods to compress and encode the voice) can be embedded into RTP packets. Vigor V models provide various codecs, including G.711 A/ $\mu$ -law, G.723, G.726 and G.729 A & B. Each codec uses a different bandwidth and hence provides different levels of voice quality. The more bandwidth a codec uses the better the voice quality, however the codec used must be appropriate for your Internet bandwidth.

### Calling via SIP Servers

First, the Vigor V models of yours will have to register to a SIP Registrar by sending registration messages to validate. Then, both parties’ SIP proxies will forward the sequence of messages to caller to establish the session.

If you both register to the same SIP Registrar, then it will be illustrated as below:

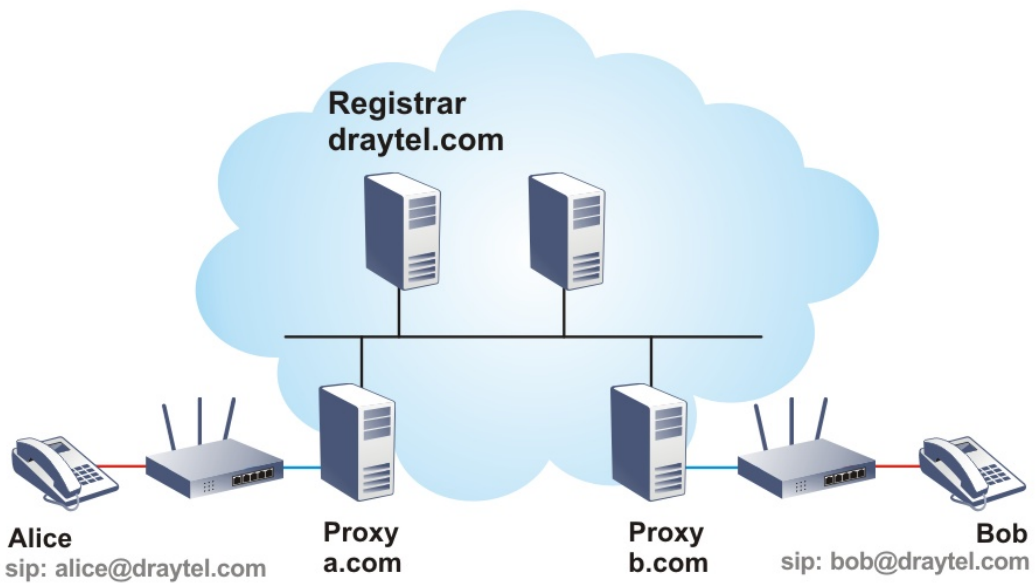

The major benefit of this mode is that you don't have to memorize your friend's IP address, which might change very frequently if it's dynamic. Instead of that, you will only have to use dial plan or directly dial your friend's account name if you are with the same SIP Registrar.

### Peer-to-Peer

Before calling, you have to know your friend's IP Address. The Vigor VoIP Routers will build connection between each other.

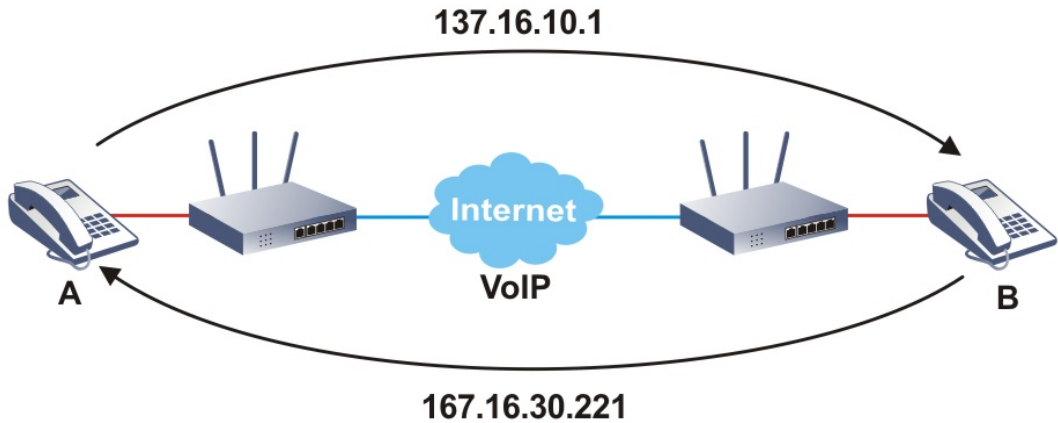

Vigor V models firstly apply efficient codecs designed to make the best use of available bandwidth, but Vigor V models also equip with automatic QoS assurance. QoS Assurance assists to assign high priority to voice traffic via Internet. You will always have the required inbound and outbound bandwidth that is prioritized exclusively for Voice traffic over Internet but you just get your data a little slower and it is tolerable for data traffic.

Our Vigor V models firstly apply efficient codecs designed to make the best use of available bandwidth, but Vigor V models also equip with automatic QoS assurance. QoS Assurance assists to assign high priority to voice traffic via Internet. You will always have the required inbound and outbound bandwidth that is prioritized exclusively for Voice traffic over Internet but you just get your data a little slower and it is tolerable for data traffic.

# Web User Interface

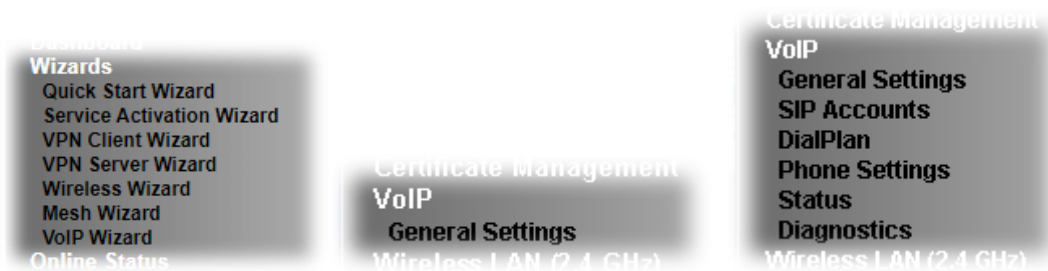

## IV-1-1 VoIP Wizard

Vigor router offers a quick method to configure settings for VoIP application. Follow the steps listed below.



Info

This wizard is available for “V” model only.

1. Open Wizards>>VoIP Wizard.
2. The screen of VoIP Wizard will be shown as follows.

VoIP Wizard

---

**Set VoIP service provider domain**

VoIP service provider	user define ▾	<input type="text"/>	(63 char max).
SIP Port	5060	<input type="text"/>	

**Set Account quickly**

Phone 1 (default mapping to Account 1)			
Account Number/Name	---	<input type="text"/>	(63 char max).
Password		<input type="text"/>	(127 char max).
Phone 2 (default mapping to Account 2)			
	<input checked="" type="checkbox"/>	use the same Account as phone1	
Account Number/Name	---	<input type="text"/>	(63 char max).
Password		<input type="text"/>	(127 char max).

Available settings are explained as follows:

Item	Description
Set VoIP service provider domain	VoIP service provider - Use the drop down list to choose the ISP which offers the VoIP service for your router. SIP Port - Use the default setting (5060).
Set Account quickly	Account Number/Name - Enter the account number/name registered to your ISP. Password - Enter the password for the account registered to your ISP.

	Use the same Account as phone 1 - If you don't need to configure Phone 2 settings, simply check this box.
Next	Click it to get into the next setting page.
Cancel	Click it to give up the VoIP wizard.

3. After finished the settings above, click Next for viewing summary of such connection.

#### VoIP Wizard

**Please confirm your settings:**

VoIP Service Provider	draytel.org
SIP Port	5060
Phone 1 Account	5633s
Phone 2 Account	5633s

Click **Back** to modify changes if necessary. Otherwise, click **Finish** to save current settings.

4. Click Finish. A page of VoIP Wizard Setup OK!!! will appear.

**VoIP Wizard Setup OK!**

## IV-1-2 General Settings

Open VoIP>>General Settings. The following page will appear. Check the box of Enable VoIP and click OK to open the configuration page. If not, no settings will be displayed.

VoIP >> General Settings

Enable VoIP

**Note:**  
If VoIP is disabled, there will be no power supplied to the FXS ports.

OK

After checking the box and click OK, the menu items under VoIP will be shown as follows.



Again, open VoIP>>General Settings. The following page appears for you to configure secure phone, IP call; and set NAT Traversal Setting, RTP for the VoIP function.

VoIP >> General Settings

Enable VoIP

**Note:**  
If VoIP is disabled, the FXS ports will connect to the line port.

**Secure Phone**

Enable Secure Phone (ZRTP+SRTP)

Enable SAS Voice Prompt

**NAT Traversal Setting**

STUN Server

External IP

SIP PING Interval  sec

**RTP**

Symmetric RTP

Dynamic RTP Port Start

Dynamic RTP Port End

RTP TOS

**IP Call**

Enable IP Call

OK

Available settings are explained as follows:

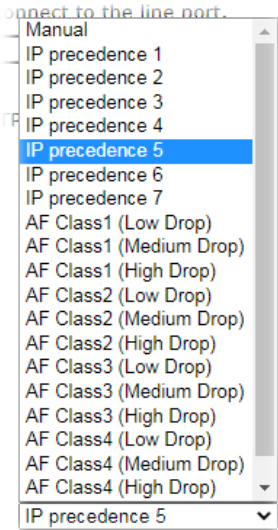
Item	Description
Secure Phone	<p>Enable Secure Phone - It allows users to have encrypted RTP stream with the peer side using the same protocol (ZRTP+SRTP). Check this box to have secure call.</p> <p>Enable SAS Voice Prompt - If it is enabled, SAS prompt will be heard for both ends every time. If it is disabled, no SAS prompt will be heard any more.</p>
NAT Traversal Setting	<p>STUN Server - Type in the IP address or domain of the STUN server.</p> <p>External IP - Type in the gateway IP address.</p> <p>SIP PING interval - The default value is 150 (sec). It is useful for a Nortel server NAT Traversal Support.</p>
RTP	<p>Symmetric RTP - Check this box to invoke the function. To make the data transmission going through on both ends of local router and remote router not misleading due to IP lost (for example, sending data from the public IP of remote router to the private IP of local router), you can check this box to solve this problem.</p> <p>Dynamic RTP Port Start - Specifies the start port for RTP stream. The default value is 10050.</p> <p>Dynamic RTP Port End - Specifies the end port for RTP stream. The default value is 15000.</p> <p>RTP TOS - It decides the level of VoIP package. Use the drop down list to choose any one of them.</p> 
IP Call	<p>Enable IP Call - It allows that a user could dial outgoing IP Calls; and Vigor router could receive the incoming IP Calls.</p>

### Application for Secure Phone

Enable SAS Voice Prompt, for ex: if vigor router A calls vigor router B with checking Enable Secure Phone and Enable SAS Voice Prompt, then:

1. After the connection established, vigor router A will send SAS voice prompt to A and vigor router B will send the SAS voice prompt to B.
2. Then the RTP traffic is secured until the call ends.

3. If vigor router A wants to call vigor router B again next time, both A and B will not hear any voice prompt again even checking Enable SAS Voice Prompt on web UI. It means only the first call between them will have voice prompt.

Enable SAS Voice Prompt, for ex: if vigor router A calls vigor router B with checking Enable Secure Phone but not Enable SAS Voice Prompt, then:

1. After the connection established, vigor router A will NOT send SAS voice prompt to vigor router A and vigor router B will NOT send the SAS voice prompt to vigor router B.
2. Even no voice prompt, but the RTP traffic is still secured until the call ends.



---

Info

---

If the incoming or outgoing calls do not match any entry on the phonebook, the router will try to make the call "being protected". But, if the call ends up "unprotected"(e.g. peer side does not support ZRTP+SRTP), the router will not play out a warning message.

---



## IV-1-3 SIP Accounts

In this section, you set up your own SIP settings. When you apply for an account, your SIP service provider will give you an Account Name or user name, SIP Registrar, Proxy, and Domain name. (The last three might be the same in some case). Then you can tell your folks your SIP Address as in Account Name@ Domain name

As Vigor VoIP Router is turned on, it will first register with Registrar using AuthorizationUser@Domain/Realm. After that, your call will be bypassed by SIP Proxy to the destination using AccountName@Domain/Realm as identity.



Info

Selection items for Ring Port will differ according to the router you have.

VoIP >> SIP Accounts



SIP Accounts List

Refresh

Index	Profile	Domain/Realm	Proxy	Account Name	Codec	Ring Port		Status
<a href="#">1</a>				---	G.729A/B	<input type="checkbox"/> Phone1	<input type="checkbox"/> Phone2	-
<a href="#">2</a>				---	G.729A/B	<input type="checkbox"/> Phone1	<input type="checkbox"/> Phone2	-
<a href="#">3</a>				---	G.729A/B	<input type="checkbox"/> Phone1	<input type="checkbox"/> Phone2	-
<a href="#">4</a>				---	G.729A/B	<input type="checkbox"/> Phone1	<input type="checkbox"/> Phone2	-
<a href="#">5</a>				---	G.729A/B	<input type="checkbox"/> Phone1	<input type="checkbox"/> Phone2	-
<a href="#">6</a>				---	G.729A/B	<input type="checkbox"/> Phone1	<input type="checkbox"/> Phone2	-
<a href="#">7</a>				---	G.729A/B	<input type="checkbox"/> Phone1	<input type="checkbox"/> Phone2	-
<a href="#">8</a>				---	G.729A/B	<input type="checkbox"/> Phone1	<input type="checkbox"/> Phone2	-
<a href="#">9</a>				---	G.729A/B	<input type="checkbox"/> Phone1	<input type="checkbox"/> Phone2	-
<a href="#">10</a>				---	G.729A/B	<input type="checkbox"/> Phone1	<input type="checkbox"/> Phone2	-
<a href="#">11</a>				---	G.729A/B	<input type="checkbox"/> Phone1	<input type="checkbox"/> Phone2	-
<a href="#">12</a>				---	G.729A/B	<input type="checkbox"/> Phone1	<input type="checkbox"/> Phone2	-

R: success registered on SIP server  
-: fail to register on SIP server

[Alias List](#)

OK

Available settings are explained as follows:

Item	Description
Index	Click this link to access into next page for setting SIP account.
Profile	Display the profile name of the account.
Domain/Realm	Display the domain name or IP address of the SIP registrar server.
Proxy	Display the domain name or IP address of the SIP proxy server.
Account Name	Display the account name of SIP address before @.
Codec	Display the codec type for the account.
Ring Port	Specify which port will ring when receiving a phone call.

Status	Show the status for the corresponding SIP account. R means such account is registered on SIP server successfully. - means the account is failed to register on SIP server.
Alias List	Allows you to set multiple SIP alias names.

Click any index link to access into the following page for configuring SIP account.

VoIP >> SIP Accounts

SIP Account Index No. 1

Profile Name	<input type="text" value="iptel"/> (11 char max.)
Register via	<input type="button" value="Auto"/> <input type="checkbox"/> Call without Registration
SIP Port	<input type="text" value="5060"/>
Domain/Realm	<input type="text" value="iptel.org"/>
Proxy	<input type="text" value="iptel.org"/>
<input type="checkbox"/> Act as outbound proxy	
Display Name	<input type="text" value="diegolee415203"/>
Account Number/Name	<input type="text" value="diegolee415203"/>
<input type="checkbox"/> Authentication ID	<input type="text" value="diegolee415203"/>
Password	<input type="text" value="*****"/>
Expiry Time	<input type="button" value="1 hour"/> <input type="text" value="3600"/> sec
NAT Traversal Support	<input type="button" value="None"/>
Mapping to Alias List	<input type="button" value="None"/>
Call Forwarding	<input type="button" value="Disable"/>
SIP URL	<input type="text"/>
Time Out	<input type="text" value="30"/> sec
Ring Port	<input checked="" type="checkbox"/> Phone1 <input checked="" type="checkbox"/> Phone2
Ring Pattern	<input type="button" value="1"/>
Prefer Codec	<input type="button" value="G.711MU (64Kbps)"/> <input type="checkbox"/> Single Codec
Packet Size	<input type="button" value="20ms"/>
Voice Active Detector	<input type="button" value="Off"/>

Available settings are explained as follows:

Item	Description
Profile Name	Assign a name for this profile for identifying. You can type similar name with the domain. For example, if the domain name is <i>draytel.org</i> , then you might set <i>draytel-1</i> in this field.
Register via	If you want to make VoIP call without register personal information, please choose None and check the box to achieve the goal. Some SIP server allows user to use VoIP function without registering. For such server, please check the box of Call without Registration. Choosing Auto is recommended. The system will select a proper way for your VoIP call.
SIP Port	Set the port number for sending/receiving SIP message for building a session. The default value is 5060. Your peer must set the same value in his/her Registrar.
Domain/Realm	Set the domain name or IP address of the SIP Registrar server.
Proxy	Set domain name or IP address of SIP proxy server. By the time you can type :port number after the domain name to specify that port as the destination of data transmission

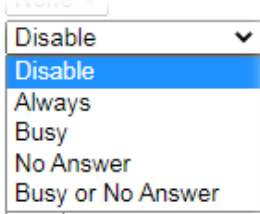
	(e.g., nat.draytel.org:5065)
Act as Outbound Proxy	Check this box to make the proxy acting as outbound proxy.
Display Name	The caller-ID that you want to be displayed on your friend's screen.
Account Number/Name	Enter your account name of SIP Address, e.g. every text before @.
Authentication ID	Check the box to invoke this function and enter the name or number used for SIP Authorization with SIP Registrar. If this setting value is the same as Account Name, it is not necessary for you to check the box and set any value in this field.
Password	The password provided to you when you registered with a SIP service.
Expiry Time	The time duration that your SIP Registrar server keeps your registration record. Before the time expires, the router will send another register request to SIP Registrar again.
NAT Traversal Support	<p>If the router (e.g., broadband router) you use connects to internet by other device, you have to set this function for your necessity.</p> <p>None - Disable this function.</p> <p>Stun - Choose this option if there is Stun server provided for your router.</p> <p>Manual - Choose this option if you want to specify an external IP address as the NAT transversal support.</p> <p>Nortel - If the soft-switch that you use supports Nortel solution, you can choose this option.</p>
Mapping to Alias List	Select one of the alias profiles.
Call Forwarding	<p>There are four options for you to choose. Disable is to close call forwarding function. Always means all the incoming calls will be forwarded into SIP URL without any reason. Busy means the incoming calls will be forwarded into SIP URL only when the local system is busy. No Answer means if the incoming calls do not receive any response, they will be forwarded to the SIP URL by the time out.</p>  <p>SIP URL - Type in the SIP URL (e.g., aaa@draytel.org or abc@iptel.org) as the site for call forwarded.</p> <p>Time Out - Set the time out for the call forwarding. The default setting is 30 sec.</p>
Ring Port	Set Phone 1 and/or Phone 2 as the default ring port(s) for this SIP account.
Ring Pattern	Choose a ring tone type for the VoIP phone call.

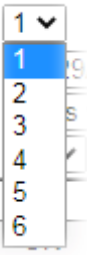
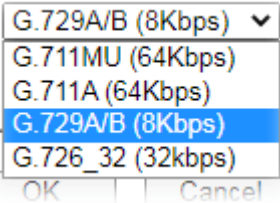
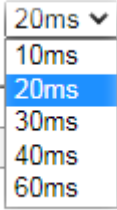
	
Prefer Codec	<p>Select one of five codecs as the default for your VoIP calls. The codec used for each call will be negotiated with the peer party before each session, and so may not be your default choice. The default codec is G.729A/B; it occupies little bandwidth while maintaining good voice quality.</p> <p>If your upstream speed is only 64Kbps, do not use G.711 codec. It is better for you to have at least 256Kbps upstream if you would like to use G.711.</p>  <p>Single Codec - If the box is checked, only the selected Codec will be applied.</p>
Packet Size	<p>The amount of data contained in a single packet. The default value is 20 ms, which means the data packet will contain 20 ms voice information.</p> 
Voice Active Detector	<p>This function can detect if the voice on both sides is active or not. If not, the router will do something to save the bandwidth for other using. Click On to invoke this function; click Off to close the function.</p>

After finishing all the settings here, please click OK to save the configuration.

#### IV-1-3-1 Alias List

This page lists all SIP alias profiles.

A SIP alias is just like an extension number in that people can dial it to reach a specific person directly. Normally, when you have a user account for one ITSP, the ITSP will provide you one SIP account. However, with this feature, you can own multiple SIP alias over one SIP account. When you register with a regular user account, the alias is registered as well as the main SIP account. Then, when somebody dials the alias, the SIP URI bound to the alias will ring.

Click the Alias List link to access the configuration page as shown below.

VoIP >> Alias

Alias List

Index	Profile Name	Number	Active	Account
<a href="#">1.</a>			No	
<a href="#">2.</a>			No	
<a href="#">3.</a>			No	
<a href="#">4.</a>			No	
<a href="#">5.</a>			No	
<a href="#">6.</a>			No	
<a href="#">7.</a>			No	
<a href="#">8.</a>			No	
<a href="#">9.</a>			No	
<a href="#">10.</a>			No	

<< [1-10](#) | [11-20](#) | [21-30](#) >>

[Next](#) >>

Available settings are explained as follows:

Item	Description
Index	Click the number link for each profile.
Profile Name	Display the alias name for such sub account.
Number	Display the phone number of such account.
Active	Display current activation status for such account, enabled or disabled.
Account	Display the SIP account number for such sub account attached.

You can set 30 profiles as alias. Click the number under Index to set detailed configuration.

VoIP >> Alias

Alias 1.

Active	<input checked="" type="radio"/> Enable <input type="radio"/> Disable
Alias Name	<input type="text" value="522293"/>
Alias Number	<input type="text" value="522293"/>
Alias of SIP account	<input type="text" value="1 - diegolee415203"/>

Available settings are explained as follows:

Item	Description
Active	Click Enable to activate this entry. Or, click Disable to inactive this entry.
Alias Name	Specify a name for an alias number.
Alias Number	Enter an alias number. The alias numbers are obtained from your ITSP.
Alias of SIP account	Choose one of the items listed in SIP account list for this alias profile.

After finishing all the settings here, please click OK to save the configuration.

Alias List

Index	Profile Name	Number	Active	Account
<u>1.</u>	522293	522293	Yes	diegolee415203
<u>2.</u>			No	
<u>3.</u>			No	
<u>4.</u>			No	
<u>5.</u>			No	
<u>6.</u>			No	
<u>7.</u>			No	
<u>8.</u>			No	
<u>9.</u>			No	
<u>10.</u>			No	

<< [1-10](#) | [11-20](#) | [21-30](#) >>

[Next](#) >>

## IV-1-4 DialPlan

This page allows you to set phone book, digit map, call barring, and regional settings for the VoIP function. Click the links on this page to access into next pages for detailed settings.

### IV-1-4-1 Phone Book

In this section, you can set your VoIP contacts in the “phonebook”. It can help you to make calls quickly and easily by using “speed-dial” Phone Number. There are total 60 index entries in the phonebook for you to store all your friends and family members’ SIP addresses. Loop through and Backup Phone Number will be displayed if you are using Vigor2927 series for setting the phone book.

VoIP >> DialPlan Setup

Phone Book		Digit Map	Call Barring	Regional		
Index	Phone Number	Display Name	SIP URL	Dial Out Account	Secure Phone	Status
<a href="#">1.</a>				Default	None	x
<a href="#">2.</a>				Default	None	x
<a href="#">3.</a>				Default	None	x
<a href="#">4.</a>				Default	None	x
<a href="#">5.</a>				Default	None	x
<a href="#">6.</a>				Default	None	x
<a href="#">7.</a>				Default	None	x
<a href="#">8.</a>				Default	None	x
<a href="#">9.</a>				Default	None	x
<a href="#">10.</a>				Default	None	x
<a href="#">11.</a>				Default	None	x
<a href="#">12.</a>				Default	None	x
<a href="#">13.</a>				Default	None	x
<a href="#">14.</a>				Default	None	x
<a href="#">15.</a>				Default	None	x
<a href="#">16.</a>				Default	None	x
<a href="#">17.</a>				Default	None	x
<a href="#">18.</a>				Default	None	x
<a href="#">19.</a>				Default	None	x
<a href="#">20.</a>				Default	None	x

<< [1-20](#) | [21-40](#) | [41-60](#) >>

[Next](#) >>

Status: v --- Active, x --- Inactive

Click any index number to display the dial plan setup page.

VoIP >> DialPlan Setup

Phone Book Index No. 1

<input checked="" type="checkbox"/> Enable	
Phone Number	<input type="text" value="0910234567"/>
Display Name	<input type="text" value="Polly"/>
SIP URL	<input type="text" value="1112"/> @ <input type="text" value="fwd.pulver.com"/>
Dial Out Account	<input type="text" value="Default"/>
Secure Phone	<input type="text" value="None"/>

Available settings are explained as follows:

Item	Description
Enable	Click this to enable this entry.
Phone Number	The speed-dial number of this index. This can be any number you choose, using digits 0-9 and * .
Display Name	The Caller-ID that you want to be displayed on your friend's screen. This let your friend can easily know who's calling without memorizing lots of SIP URL Address.
SIP URL	Enter your friend's SIP Address.
Dial Out Account	Choose one of the SIP accounts for this profile to dial out. It is useful for both sides (caller and callee) that registered to different SIP Registrar servers. If caller and callee do not use the same SIP server, sometimes, the VoIP phone call connection may not succeed. By using the specified dial out account, the successful connection can be assured.
Secure Phone	ZRTP+SRTP - It allows users to have encrypted RTP stream with the peer side using the same protocol (ZRTP+SRTP). Check this box to have secure call.
Cancel	Return to previous web page.

After finishing all the settings here, please click OK to save the configuration.



**Info**

If the incoming or outgoing calls do not match any entry on the phonebook, the router will try to make the call "being protected". But, if the call ends up "unprotected"(e.g. peer side does not support ZRTP+SRTP), the router will not play out a warning message.

#### IV-1-4-2 Digit Map

For the convenience of user, this page allows users to edit prefix number for the SIP account with adding number, stripping number or replacing number. It is used to help user have a quick and easy way to dial out through VoIP interface.





Phone Book		Digit Map		Call Barring		Regional			
#	Enable	Match Prefix	Mode	OP Number	Min Len	Max Len	Route	Move Up	Move Down
1	<input checked="" type="checkbox"/>	03	Replace	8863	7	8	VoIP1		Down
2	<input checked="" type="checkbox"/>	886	Strip	886	9	10	VoIP2	UP	Down
3	<input type="checkbox"/>		None		0	0	None	UP	Down
4	<input type="checkbox"/>		None		0	0	None	UP	Down
5	<input type="checkbox"/>		None		0	0	None	UP	Down
6	<input type="checkbox"/>		None		0	0	None	UP	Down
7	<input type="checkbox"/>		None		0	0	None	UP	Down
8	<input type="checkbox"/>		None		0	0	None	UP	Down
9	<input type="checkbox"/>		None		0	0	None	UP	Down
10	<input type="checkbox"/>		None		0	0	None	UP	Down
11	<input type="checkbox"/>		None		0	0	None	UP	Down
12	<input type="checkbox"/>		None		0	0	None	UP	Down
13	<input type="checkbox"/>		None		0	0	None	UP	Down
14	<input type="checkbox"/>		None		0	0	None	UP	Down
15	<input type="checkbox"/>		None		0	0	None	UP	Down
16	<input type="checkbox"/>		None		0	0	None	UP	Down
17	<input type="checkbox"/>		None		0	0	None	UP	Down
18	<input type="checkbox"/>		None		0	0	None	UP	Down
19	<input type="checkbox"/>		None		0	0	None	UP	Down
20	<input type="checkbox"/>		None		0	0	None	UP	

**Note:**

1. The length for Min Len and Max Len fields should be between 0~25.
2. Wildcard '?' is supported.

OK

Cancel

Available settings are explained as follows:

Item	Description
Enable	Check this box to invoke this setting.
Match Prefix	It is used to match with the number you dialed and may be modified by the action (add, strip or replace) with the OP Number.
Mode	<p>None - No action.</p> <p>Add - When you choose this mode, the OP number will be added before the match prefix number for calling out through the specific route.</p> <p>Strip - When you choose this mode, the partial or whole match prefix number will be deleted according to the OP number. Take the above picture (Prefix Table Setup web page) as an example, the OP number of 886 will be deleted completely for the match prefix number is set with 886.</p> <p>Replace - When you choose this mode, the OP number will be replaced by the prefix number for calling out through the specific VoIP interface. Take the above picture (Prefix Table Setup web page) as an example, the prefix number of 03 will be replaced by 8863. For example: dial number of "03111111" will be changed to "8863111111" and sent to SIP server.</p>

<b>OP Number</b>	The front number you type here is the first part of the account number that you want to execute special function (according to the chosen mode) by using the prefix number.
<b>Min Len</b>	Set the minimal length of the dial number for applying the prefix number settings. Take the above picture (Prefix Table Setup web page) as an example, if the dial number is between 7 and 9, that number can apply the prefix number settings here.
<b>Max Len</b>	Set the maximum length of the dial number for applying the prefix number settings.
<b>Route</b>	Choose the one that you want to enable the prefix number settings from the saved SIP accounts. Please set up one SIP account first to make this interface available. This item will be changed according to the port settings configured in VoIP>> Phone Settings.
<b>Move UP /Move Down</b>	Click the link to move the selected entry up or down.

After finishing all the settings here, please click OK to save the configuration.

### IV-1-4-3 Call Barring

Call barring is used to block phone calls coming from the one that is not welcomed.

VoIP >> DialPlan Setup



Phone Book	Digit Map	Call Barring	Regional			
<a href="#">Set to Factory Default</a>						
Index	Call Direction	Barring Type	Barring Number/URL/URI	Route	Schedule	Status
1.				Wizard1		x
2.				Wizard1		x
3.				Wizard1		x
4.				Wizard1		x
5.				Wizard1		x
6.				Wizard1		x
7.				Wizard1		x
8.				Wizard1		x
9.				Wizard1		x
10.				Wizard1		x

<< 1-10 | 11-20 >>

[Next >>](#)

**Block Anonymous**

Route  Phone1  Phone2

Index(1-15) in [Schedule](#) Setup , , ,

**Note:**  
Block the incoming calls which do not have the caller ID.

**Block Unknown Domain**

Route  Phone1  Phone2

Index(1-15) in [Schedule](#) Setup , , ,

**Note:**  
If the domain of the incoming call is different from the domain found in SIP accounts, the call should be blocked.

**Block IP Address**

Route  Phone1  Phone2

Index(1-15) in [Schedule](#) Setup , , ,

**Note:**  
The incoming calls by means of IP dialing (e.g.#192\*168\*1\*1#) should be blocked.

Additionally, you can set advanced settings for call barring such as Block Anonymous, Block Unknown Domain or Block IP Address.

For Block Anonymous - this function can block the incoming calls without caller ID on the interface (Phone port) specified in the following window. Such control also can be done based on preconfigured schedules.

For Block Unknown Domain - this function can block incoming calls (through Phone port) from unrecognized domain that is not specified in SIP accounts. Such control also can be done based on preconfigured schedules.

For Block IP Address - this function can block incoming calls (through Phone port) coming from IP address. Such control also can be done based on preconfigured schedules.

Click any index number to display the call barring setup page.

VoIP >> DialPlan Setup

Call Barring Index No. 1

<input checked="" type="checkbox"/> Enable	
Call Direction	IN ▾
Barring Type	Specific URI/URL ▾
Specific URI/URL	<input type="text"/>
Route	All ▾
Index(1-15) in <a href="#">Schedule Setup</a>	<input type="text"/> , <input type="text"/> , <input type="text"/> , <input type="text"/>

Note:

Wildcard '?' is supported.

OK Cancel

Available settings are explained as follows:

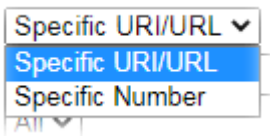
Item	Description
Enable	Check it to enable this entry.
Call Direction	Determine the direction for the phone call, IN - incoming call, OUT-outgoing call, IN & OUT - both incoming and outgoing calls.
Barring Type	Determine the type of the VoIP phone call, URI/URL or number. 
Specific URI/URL or Specific Number	This field will be changed based on the type you selected for barring Type.
Route	All means all the phone calls will be blocked with such mechanism.
Index (1-15) in Schedule	Enter the index of schedule profiles to control the call barring according to the preconfigured schedules. Refer to section Applications>>Schedule for detailed configuration.

## IV-1-4-4 Regional

This page allows you to process incoming or outgoing phone calls by regional. Default values (common used in most areas) will be shown on this web page. You *can change* the number based on the region that the router is placed.

VoIP >> DialPlan Setup

Phone Book	Digit Map	Call Barring	Regional
<input checked="" type="checkbox"/> Enable Regional			<a href="#">Set to Factory Default</a>
Last Call Return [Miss]:	<input type="text" value="*69"/>		
Last Call Return [In]:	<input type="text" value="*12"/>	Last Call Return [Out]:	<input type="text" value="*14"/>
Call Forward [All] [Act]:	<input type="text" value="*72"/> +number+#	Call Forward [Deact]:	<input type="text" value="*73"/> +##
Call Forward [Busy] [Act]:	<input type="text" value="*90"/> +number+#	Call Forward [No Ans] [Act]:	<input type="text" value="*92"/> +number+#
Do Not Disturb [Act]:	<input type="text" value="*78"/> +##	Do Not Disturb [Deact]:	<input type="text" value="*79"/> +##
Hide caller ID [Act]:	<input type="text" value="*67"/> +##	Hide caller ID [Deact]:	<input type="text" value="*68"/> +##
Call Waiting [Act]:	<input type="text" value="*56"/> +##	Call Waiting [Deact]:	<input type="text" value="*57"/> +##
Block Anonymous [Act]:	<input type="text" value="*77"/> +##	Block Anonymous [Deact]:	<input type="text" value="*87"/> +##
Block Unknow Domain [Act]:	<input type="text" value="*40"/> +##	Block Unknow Domain [Deact]:	<input type="text" value="*04"/> +##
Block IP Calls [Act]:	<input type="text" value="*50"/> +##	Block IP Calls [Deact]:	<input type="text" value="*05"/> +##
Block Last Calls [Act]:	<input type="text" value="*60"/> +##		

Available settings are explained as follows:

Item	Description
Enable Regional	Check this box to enable this function.
Last Call Return [Miss]	Sometimes, people might miss some phone calls. Please dial number typed in this field to know where the last phone call comes from and call back to that one.
Last Call Return [In]	You have finished an incoming phone call, however you want to call back again for some reason. Please dial number typed in this field to call back to that one.
Last Call Return [Out]	Dial the number typed in this field to call the previous outgoing phone call again.
Call Forward [All][Act]	Dial the number typed in this field to forward all the incoming calls to the specified place.
Call Forward [Deact]	Dial the number typed in this field to release the call forward function.
Call Forward [Busy][Act]	Dial the number typed in this field to forward all the incoming calls to the specified place while the phone is busy.
Call Forward [No Ans][Act]	Dial the number typed in this field to forward all the incoming calls to the specified place while there is no answer of the connected phone.
Do Not Disturb [Act]	Dial the number typed in this field to invoke the function of DND.
Do Not Distrub [Deact]	Dial the number typed in this field to release the DND function.

Hide caller ID [Act]	Dial the number typed in this field to make your phone number (ID) not displayed on the display panel of remote end.
Hide caller ID [Deact]	Dial the number typed in this field to release this function.
Call Waiting [Act]	Dial the number typed in this field to make all the incoming calls waiting for your answer.
Call Waiting [Deact]	Dial the number typed in this field to release this function.
Block Anonymous[Act]	Dial the number typed in this field to block all the incoming calls with unknown ID.
Block Anonymous[Deact]	Dial the number typed in this field to release this function.
Block Unknown Domain [Act]	Dial the number typed in this field to block all the incoming calls from unknown domain.
Block Unknown Domain [Deact]	Dial the number typed in this field to release this function.
Block IP Calls [Act]	Dial the number typed in this field to block all the incoming calls from IP address.
Block IP Calls [Deact]	Dial the number typed in this field to release this function.
Block Last Calls [Act]	Dial the number typed in this field to block the last incoming phone call.

After finishing all the settings here, please click OK to save the configuration.

---

## IV-1-5 Phone Settings

This page allows user to set phone settings for Phone 1 and Phone 2 respectively. However, it changes slightly according to different model you have.

VoIP >> Phone Settings

---

### Phone Setting

Index	Port	Call Feature	Tone	Gain (Mic/Speaker)	Default SIP Account	DTMF Relay
<u>1</u>	Phone1	CW,CT,	Taiwan	5/5		OutBand
<u>2</u>	Phone2	CW,CT,	Taiwan	5/5		OutBand

Available settings are explained as follows:

Item	Description
Phone Setting	<p>Index - there are two phone ports provided here for you to configure.</p> <p>Port - Display phone1 and phone2.</p> <p>Call Feature - A brief description for call feature will be shown in this field for your reference.</p> <p>Tone - Display the tone settings that configured in the advanced settings page of Phone Index.</p> <p>Gain - Display the volume gain settings for Mic/Speaker that configured in the advanced settings page of Phone Index.</p> <p>Default SIP Account - "draytel_1" is the default SIP account. You can click the number below the Index field to change SIP account for each phone port.</p> <p>DTMF Relay - Display DTMF mode that configured in the advanced settings page of Phone Index.</p>

After finishing all the settings here, please click OK to save the configuration.

## Detailed Settings for Phone Port

Click the index number link for Phone port, you can access into the following page for configuring Phone settings.

VoIP >> Phone Settings

Phone1

<p><b>Call Feature</b></p> <p><input type="checkbox"/> Hotline <input type="text"/></p> <p><input type="checkbox"/> Session Timer <input type="text" value="90"/> sec</p> <p><input type="checkbox"/> T.38 Fax Function Error Correction Mode <input type="text" value="REDUNDANCY"/></p> <p><input type="checkbox"/> DND(Do Not Disturb) Mode Index(1-15) in <b>Schedule</b> Setup: <input type="text"/>, <input type="text"/>, <input type="text"/>, <input type="text"/></p> <p><b>Note:</b> Action and Idle Timeout settings will be ignored. Index(1-60) in <b>Phone Book</b> as Exception List: <input type="text"/>, <input type="text"/>, <input type="text"/>, <input type="text"/>, <input type="text"/></p> <p><input type="checkbox"/> CLIR (hide caller ID)</p> <p><input checked="" type="checkbox"/> Call Waiting</p> <p><input checked="" type="checkbox"/> Call Transfer</p>	<p><b>Default SIP Account</b> <input type="text"/></p> <p><input type="checkbox"/> Play dial tone only when account registered</p>
---	--

Available settings are explained as follows:

Item	Description
Hotline	Check the box to enable it. Type in the SIP URL in the field for dialing automatically when you pick up the phone set.
Session Timer	Check the box to enable the function. In the limited time that you set in this field, if there is no response, the connecting call will be closed automatically.
T.38 Fax Function	Check the box to enable T.38 fax function. Error Correction Mode - choose a mode for error correction.
DND (Do Not Disturb) mode	Set a period of peace time without disturbing by VoIP phone call. During the period, the one who dial in will listen busy tone, yet the local user will not listen any ring tone. Index (1-15) in Schedule - Enter the index of schedule profiles to control when the phone will ring and when will not according to the preconfigured schedules. Refer to section Application >>Schedule for detailed configuration. Index (1-60) in Phone Book - Enter the index of phone book profiles. Refer to section DialPlan - Phone Book for detailed configuration.
CLIR (hide caller ID)	Check this box to hide the caller ID on the display panel of the phone set.
Call Waiting	Check this box to invoke this function. A notice sound will appear to tell the user new phone call is waiting for your response. Click hook flash to pick up the waiting phone call.
Call Transfer	Check this box to invoke this function. Click hook flash to initiate another phone call. When the phone call connection succeeds, hang up the phone. The other two sides can communicate, then.



Default SIP Account	<p>You can set SIP accounts (up to six groups) on SIP Account page. Use the drop down list to choose one of the profile names for the accounts as the default one for this phone setting.</p> <p>Play dial tone only when account registered - Check this box to invoke the function.</p>
---------------------	---

In addition, you can press the Advanced button to configure tone settings, volume gain, MISC and DTMF mode. Advanced setting is provided for fitting the telecommunication custom for the local area of the router installed. Wrong tone settings might cause inconvenience for users. To set the sound pattern of the phone set, simply choose a proper region to let the system find out the preset tone settings and caller ID type automatically. Or you can adjust tone settings manually if you choose User Defined. TOn1, TOff1, TOn2 and TOff2 mean the cadence of the tone pattern. TOn1 and TOn2 represent sound-on; TOff1 and TOff2 represent the sound-off.

VoIP >> Phone Settings

Advance Settings >> Phone 1

Tone Settings						
Region	Taiwan		Caller ID Type			
	Low Freq(Hz)	High Freq(Hz)	T on 1 (msec)	T off 1 (msec)	T on 2 (msec)	T off 2 (msec)
Dial tone	350	440	0	0	0	0
Ringing tone	440	480	1000	2000	0	0
Busy tone	480	620	500	500	0	0
Congestion tone	480	620	250	250	0	0
Volume Gain			DTMF			
Mic Gain(1-10)	5		DTMF Mode		OutBand ( RFC2833)	
Speaker Gain(1-10)	5		Payload Type (RFC2833) (96 - 127)		101	
MISC			<input type="checkbox"/> Replace + digit in caller ID to <input type="text" value="00"/>			
Dial Tone Power Level (1 - 50)	27					
Ring Frequency (10 - 50HZ)	25					
Call Waiting Tone Power Level (1 - 30)	13					
Interdigit Timeout (1 - 10 sec)	4					

OK Cancel

Available settings are explained as follows:

Item	Description
Region	Select the proper region which you are located. The common settings of Caller ID Type, Dial tone, Ringing tone, Busy tone and Congestion tone will be shown automatically on the page. If you cannot find out a suitable one, please choose User Defined and fill out the corresponding values for dial tone, ringing tone, busy tone, congestion tone by yourself for VoIP phone.

	 <p>Also, you can specify each field for your necessity. It is recommended for you to use the default settings for VoIP communication.</p>
Volume Gain	Mic Gain (1-10)/Speaker Gain (1-10) - Adjust the volume of microphone and speaker by entering number from 1- 10. The larger of the number, the louder the volume is.
MISC	<p>Dial Tone Power Level - This setting is used to adjust the loudness of the dial tone. The smaller the number is, the louder the dial tone is. It is recommended for you to use the default setting.</p> <p>Ring Frequency - This setting is used to drive the frequency of the ring tone. It is recommended for you to use the default setting.</p> <p>Call Waiting Tone Power Level - This setting is used to adjust the loudness of the call waiting tone. The smaller the number is, the louder the tone is. It is recommended for you to use the default setting.</p> <p>Interdigit Timeout -Type a value in this field to specify time limit for interdigit.</p>
DTMF	<p>DTMF Mode - There are four DTMF modes for you to choose.</p> <ul style="list-style-type: none"> <li>● <i>InBand</i> - Choose this one then the Vigor will send the DTMF tone as audio directly when you press the keypad on the phone.</li> <li>● <i>OutBand</i> - Choose this one then the Vigor will capture the keypad number you pressed and transform it to digital form then send to the other side; the receiver will generate the tone according to the digital form it receive. This function is very useful when the network traffic congestion occurs and it still can remain the accuracy of DTMF tone.</li> <li>● <i>SIP INFO</i>- Choose this one then the Vigor will capture the DTMF tone and transfer it into SIP form. Then it will be sent to the remote end with SIP message.</li> </ul>

Payload Type (rfc2833) - Type a number from 96 to 127, the default value was 101. This setting is available for the OutBand (RFC2833) mode.

Replace + digit in caller ID to - For international phone call, the phone number could add a '+' sign, for example, +8865972727. However, the caller ID (DTMF type especially) can not display '+' at all.

Therefore, this function can be enabled to give another number to replace the plus sign, for example, "+" can be replaced by "00". Then the above phone number will become 008865972727. When the callee receives such number, he can use re-dial function to dial back to the caller.

## IV-1-6 Status

From this page, you can find codec, connection and other important call status for each port.

VoIP >> Status

Status		Refresh Seconds: <input type="text" value="10"/> <input type="button" value="Refresh"/>										
Port	Status	Codec	PeerID	Elapse(hh:mm:ss)	Tx Pkts	Rx Pkts	Rx Losts	Rx Jitter(ms)	In Calls	Out Calls	Miss Calls	Speaker Gain
Phone1	IDLE			00:00:00	0	0	0	0	0	0	0	5
Phone2	IDLE			00:00:00	0	0	0	0	0	0	0	5

Log

Date (mm-dd-yyyy)	Time (hh:mm:ss)	Duration (hh:mm:ss)	In/Out/Miss	Account ID	Peer ID
00-00-00	00:00:00	00:00:00	-	-	-
00-00-00	00:00:00	00:00:00	-	-	-
00-00-00	00:00:00	00:00:00	-	-	-
00-00-00	00:00:00	00:00:00	-	-	-
00-00-00	00:00:00	00:00:00	-	-	-
00-00-00	00:00:00	00:00:00	-	-	-
00-00-00	00:00:00	00:00:00	-	-	-
00-00-00	00:00:00	00:00:00	-	-	-
00-00-00	00:00:00	00:00:00	-	-	-
00-00-00	00:00:00	00:00:00	-	-	-
00-00-00	00:00:00	00:00:00	-	-	-

xxxxxxx : VoIP is encrypted.  
xxxxxxx : VoIP isn't encrypted.

Available settings are explained as follows:

Item	Description
Refresh Seconds	Specify the interval (5, 10 or 30) of refresh time to obtain the latest VoIP calling information. The information will update immediately when the Refresh button is clicked.
Port	It shows current connection status for Phone(s) ports.
Status	It shows the VoIP connection status. IDLE - Indicates that the VoIP function is idle. HANG_UP - Indicates that the connection is not established (busy tone). CONNECTING - Indicates that the user is calling out. WAIT_ANS - Indicates that a connection is launched and waiting for remote user's answer. ALERTING - Indicates that a call is coming. ACTIVE-Indicates that the VoIP connection is launched.

Codec	Indicates the voice codec employed by present channel.
PeerID	The present in-call or out-call peer ID (the format may be IP or Domain).
Elapse(hh:mm:ss)	The format is represented as hours:minutes:seconds.
Tx Pkts	Total number of transmitted voice packets during this connection session.
Rx Pkts	Total number of received voice packets during this connection session.
Rx Losts	Total number of lost packets during this connection session.
Rx Jitter	The jitter of received voice packets.
In Calls	Accumulation for the times of in call.
Out Calls	Accumulation for the times of out call.
Miss Calls	Accumulation for the times of missing call.
Speaker Gain	The volume of present call.
Log	Display logs of VoIP calls.

## IV-1-7 Diagnostics

VoIP Diagnostics is used for diagnosing if VoIP phone failure is caused by different tone or caller ID.

VoIP >> Diagnostics

VoIP Diagnostics

<u>Caller ID</u> <u>Tone</u>
---------------------------------

### IV-1-7-1 Caller ID

VoIP >> VOIP Diagnostics

Send Caller ID

FXS 1	FXS 2	FXO
Current type: <b>FSK_ETSI</b> Caller ID used to send : _____		
Item	Types	Status
<input checked="" type="radio"/>	FSK_ETSI	Untest
<input type="radio"/>	FSK_ETSI (UK)	Untest
<input type="radio"/>	FSK_BELLCORE (US/AU)	Untest
<input type="radio"/>	DTMF	Untest
<input type="radio"/>	DTMF (DK)	Untest
<input type="radio"/>	DTMF (SE/NL/FIN)	Untest
<input type="button" value="Set"/> <input type="button" value="Test"/>		

### IV-1-7-2 Tone

VoIP >> VOIP Diagnostics

Send Tone

FXS 1	FXS 2					
Region <span style="border: 1px solid black; padding: 2px;">Taiwan</span>						
	Low Freq(Hz)	High Freq(Hz)	T on 1 (msec)	T off 1 (msec)	T on 2 (msec)	T off 2 (msec)
<b>Dial tone</b>	350	440	0	0	0	0
<b>Ringing tone</b>	440	480	1000	2000	0	0
<b>Busy tone</b>	480	620	500	500	0	0
<b>Congestion tone</b>	480	620	250	250	0	0
Item	Types		Status			
<input type="radio"/>	Dial Tone		Untest			
<input type="radio"/>	Busy Tone		Untest			
<input type="radio"/>	Congestion Tone		Untest			
<input type="button" value="Set"/> <input type="button" value="Test"/>						

This page is left blank.

# Part V VPN



VPN



Certificate  
Management

A Virtual Private Network (VPN) is the extension of a private network that encompasses links across shared or public networks like the Internet. In short, by VPN technology, you can send data between two computers across a shared or public network in a manner that emulates the properties of a point-to-point private link.

A digital certificate works as an electronic ID, which is issued by a certification authority (CA). It contains information such as your name, a serial number, expiration dates etc., and the digital signature of the certificate-issuing authority so that a recipient can verify that the certificate is real. Here Vigor router support digital certificates conforming to standard X.509.

---

## V-1 VPN and Remote Access

A Virtual Private Network (VPN) is an extension of a private network that allows users to access network resources that available on the private network across shared or public networks such as the Internet, as if users are directly connected to the private network.

Here are some uses of VPNs:

- Communication between home office and customer.
- Secure connection between Teleworker, staff on business trip and main office.
- Exchange data between remote office and main office.
- POS between chain store and headquarters.
- Circumvention of Internet censorship that filters websites or contents.
- Circumvention of geolocation techniques employed by service providers or vendors to block or restrict services to users.
- Secure communications over public access points

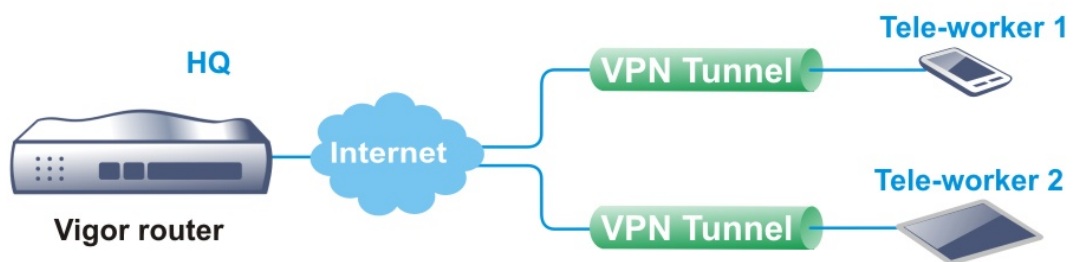



---

## Web User Interface

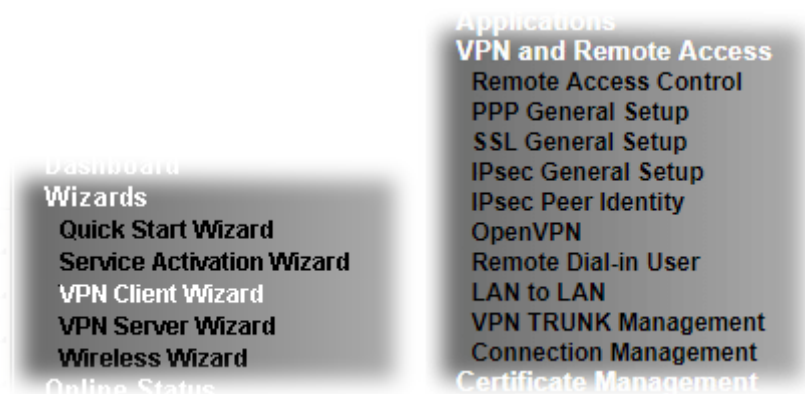

---

### V-1-1 VPN Client Wizard

The VPN Client Wizard will configure the router as a *client* to connect to a remote VPN server using a LAN-to-LAN VPN tunnel. The wizard will guide you through the setup process.

1. On the menu bar, click on Wizards, and then VPN Client Wizard.

#### VPN Client Wizard

##### Choose VPN Establishment Environment

Please choose a LAN-to-LAN Profile:

Available settings are explained as follows:

Item	Description
Please choose a LAN-to-LAN Profile	The profile used to store this tunnel configuration. Selecting an index that has already been setup previously will result in the existing setup getting overwritten by the wizard.

2. When you finish the mode and profile selection, please click Next to open the following page.

VPN Client Wizard

VPN Connection Setting

<p><b>Security Ranking:</b></p> <p><b>Very High</b> IPsec XAuth IPsec IKEv2 EAP (only for NAT Mode) L2TP over IPsec OpenVPN (AES256)</p> <p><b>High</b> IPsec IKEv1/IKEv2 SSL OpenVPN (AES128)</p> <p><b>Medium</b> PPTP (Encryption)</p> <p><b>Low</b> L2TP / PPTP (None Encryption) OpenVPN (None Encryption)</p>	<p><b>Throughput Ranking:</b></p> <p><b>Very High</b> L2TP / PPTP (None Encryption)</p> <p><b>High</b> IPsec IKEv2/EAP/IKEv1/XAuth OpenVPN (UDP None Encryption)</p> <p><b>Medium</b> L2TP over IPsec / PPTP (Encryption) OpenVPN (UDP) OpenVPN (TCP None Encryption)</p> <p><b>Low</b> SSL/OpenVPN (TCP)</p>
LAN-to-LAN VPN Client Mode Selection:	Route Mode ▾
Select VPN Type:	PPTP (Encryption) ▾
<p><b>Note:</b></p> <ol style="list-style-type: none"> <li>1. Please use Route Mode for typical LAN-to-LAN tunnels.</li> <li>2. If the remote network is only expecting a single client or IP and is not configured to route the subnet then select NAT Mode.</li> <li>3. If you are unsure of your configuration select Route Mode.</li> </ol>	

< Back    Next >    Finish    Cancel

Available settings are explained as follows:

Item	Description
LAN-to-LAN Client Mode Selection	<p>Route Mode - All traffic between the local network and the remote network bear the originating IP addresses. Select this if the VPN server can establish routes to handle inter-LAN traffic routing.</p> <p>NAT Mode - The VPN client (local router) uses a single IP address assigned by the VPN server (remote router) and uses NAT to keep track of the connections. Select this if the VPN server expects only one IP address on the local network to communicate with the remote network.</p>
Select VPN Type	Select a VPN protocol for the LAN-to-LAN tunnel. Different VPN protocols offer different levels of security and performance.



Info

The following descriptions for VPN Type are based on the Route Mode specified in LAN-to-LAN Client Mode Selection.

If you have selected PPTP (None Encryption) or PPTP (Encryption), the following configuration screen appears.

#### VPN Client Wizard

##### VPN Client PPTP Encryption Settings

Profile Name	???
VPN Dial-Out Through	WAN1 First
<input type="checkbox"/> Always on	
Server IP/Host Name for VPN (e.g. draytek.com or 123.45.67.89)	
Username	???
Password	
Remote Network IP	0.0.0.0
Remote Network Mask	255.255.255.0 / 24
Local Network IP	192.168.1.1
Local Network Mask	255.255.255.0 / 24

< Back   Next >   Finish   Cancel

If you have selected IPsec, the following configuration screen appears.

#### VPN Client Wizard

##### VPN Client IPsec Settings

Profile Name	???
VPN Dial-Out Through	WAN1 First
<input type="checkbox"/> Always on	
Server IP/Host Name for VPN (e.g. draytek.com or 123.45.67.89)	
IKE Authentication Method	
<input checked="" type="radio"/> Pre-Shared Key	
Confirm Pre-Shared Key	
<input type="radio"/> Digital Signature (X.509)	
Peer ID	None
Local ID	
<input checked="" type="radio"/> Alternative Subject Name First	
<input type="radio"/> Subject Name First	
Local Certificate	None
IPsec Security Method	
<input type="radio"/> Medium (AH)	
<input checked="" type="radio"/> High (ESP)	AES with Authentication
Remote Network IP	0.0.0.0
Remote Network Mask	255.255.255.0 / 24
Local Network IP	192.168.1.1
Local Network Mask	255.255.255.0 / 24

< Back   Next >   Finish   Cancel

If you have selected SSL/L2TP, the following configuration screen appears.

#### VPN Client Wizard

##### VPN Client L2TP Settings

Profile Name	???
VPN Dial-Out Through	WAN1 First
<input type="checkbox"/> Always on	
Server IP/Host Name for VPN (e.g. draytek.com or 123.45.67.89)	
Username	???
Password	
Remote Network IP	0.0.0.0
Remote Network Mask	255.255.255.0 / 24
Local Network IP	192.168.1.1
Local Network Mask	255.255.255.0 / 24

< Back   Next >   Finish   Cancel

If you have selected L2TP over IPsec (Nice to Have) or L2TP over IPsec (Must), the following configuration screen appears.

#### VPN Client Wizard

##### VPN Client L2TP over IPsec (Nice to Have) Settings

Profile Name	???
VPN Dial-Out Through	WAN1 First
<input type="checkbox"/> Always on	
Server IP/Host Name for VPN (e.g. draytek.com or 123.45.67.89)	
IKE Authentication Method	
<input checked="" type="radio"/> Pre-Shared Key	
Confirm Pre-Shared Key	
<input type="radio"/> Digital Signature (X.509)	
Peer ID	None
Local ID	
<input checked="" type="radio"/> Alternative Subject Name First	
<input type="radio"/> Subject Name First	
Local Certificate	None
IPsec Security Method	
<input type="radio"/> Medium (AH)	
<input checked="" type="radio"/> High (ESP)	AES with Authentication
Username	???
Password	
Remote Network IP	0.0.0.0
Remote Network Mask	255.255.255.0 / 24
Local Network IP	192.168.1.1
Local Network Mask	255.255.255.0 / 24

< Back   Next >   Finish   Cancel

If you have selected OpenVPN, the following configuration screen appears.

## VPN Client OpenVPN Encryption Settings

Profile Name	???
VPN Dial-Out Through	WAN1 First
Import OpenVPN config file	選擇檔案   未選擇任何檔案
<input type="checkbox"/> Always on	
Username	???
Password	Max: 128 characters
Remote Network IP	0.0.0.0
Remote Network Mask	255.255.255.0 / 24
Local Network IP	192.168.1.1
Local Network Mask	255.255.255.0 / 24

< Back    Next >    Finish    Cancel

Available settings are explained as follows:

Item	Description
Profile Name	Name that identifies this profile. The maximum length of the Profile Name is 10 characters.
VPN Dial-Out Through	The WAN interface to be used for dialing out to establish the VPN tunnel. <b>WANx First (or LTE First)</b> - The Router first attempts to establish the VPN tunnel using this WAN interface. When that is unsuccessful, it will attempt to use other WAN interfaces. <b>WANx Only (or LTE Only)</b> - The Router will establish the VPN tunnel using this WAN interface only. <b>WANx Only: Only establish VPN if WANYy down</b> - The Router will establish the VPN tunnel using this WAN interface if the other WAN interface is offline.
Always On	If selected, the router will maintain the VPN connection.
Server IP/Host Name for VPN	Enter the IP address or hostname of the server of the remote VPN server.
IKE Authentication Method	IKE Authentication Method to be used. Choose between Pre-shared Key and Digital Signature (X.509). <b>Pre-shared Key</b> <ul style="list-style-type: none"> <li>● Pre-Shared Key- Specify a key for IKE authentication.</li> <li>● Confirm Pre-Shared Key-Confirm the pre-shared key.</li> </ul> <b>Digital Signature (X.509)</b> <ul style="list-style-type: none"> <li>● Peer ID - Select Peer ID from the dropdown list. Peer IDs are managed using VPN and Remote Access &gt;&gt; IPsec Peer Identity.</li> <li>● Local ID - Select Alternative Subject Name First or Subject Name First.</li> <li>● Local Certificate - Select a certificate from the dropdown list. Local certificates are managed using</li> </ul>

Certificate Management >> Local Certificate.	
IPsec Security Method	<p>Medium - Authentication Header (AH) means data will be authenticated, but not be encrypted. By default, this option is active.</p> <p>High - Encapsulating Security Payload (ESP) means payload (data) will be encrypted and authenticated. You may select encryption algorithm from Data Encryption Standard (DES), Triple DES (3DES), and AES.</p>
Import OpenVPN config file	<p>Select to import an OpenVPN configuration file from a specified OpenVPN server (e.g., Vigor router, PC, other VPN provider and etc.) onto to Vigor router.</p> <p>Later, as a VPN client, this router can access into VPN server via the username and password.</p>
Username	<p>This field is used to authenticate for connection when you select PPTP or L2TP with or without IPsec policy above.</p> <p>The length of the user name is limited to 11 characters.</p>
Password	<p>This field is used to authenticate for connection when you select PPTP or L2TP with or without IPsec policy above.</p> <p>The length of the password is limited to 11 characters.</p>
Remote Network IP	Please enter one LAN IP address (according to the real location of the remote host) for building VPN connection.
Remote Network Mask	Please enter the network mask (according to the real location of the remote host) for building VPN connection.
Local Network IP	Enter the local network IP for TCP / IP configuration.
Local Network Mask	Enter the local network mask for TCP / IP configuration.

- After you have entered all the required information, click Next to proceed to the confirmation page. The confirmation page shows a summary of all the settings. If you need to make adjustments to the settings, click Back to return to the previous page. Otherwise, select one of the following actions and click Finish to save the changes to the LAN-to-LAN VPN profile.

#### VPN Client Wizard

##### Please confirm your settings

LAN-to-LAN Index:	1
Profile Name:	???
VPN Connection Type:	L2TP over IPsec (Nice to Have)
VPN Dial-Out Through:	WAN1 First
Always on:	Yes
Server IP/Host Name:	172.16.3.8
IKE Authentication Method:	Pre-Shared Key
IPsec Security Method:	AES with Authentication
Remote Network IP:	172.16.3.89
Remote Network Mask:	255.255.255.0
Local Network IP:	192.168.1.15
Local Network Mask:	255.255.255.0

Click **Back** to modify changes if necessary. Otherwise,click **Finish** to save the current settings and proceed to the following action:

Go to the VPN Connection Management.  
 Do another VPN Client Wizard setup.  
 View more detailed configurations.

Available settings are explained as follows:

Item	Description
Go to the VPN Connection Management	Proceed to VPN and Remote Access>>Connection Management to manage VPN sessions.
Do another VPN Client Wizard Setup	Rerun the VPN Client Wizard to configure another LAN-to-LAN VPN profile.
View more detailed configuration	Open this profile in VPN and Remote Access>>LAN to LAN to make additional configuration changes.

---

## V-1-2 VPN Server Wizard

The VPN Server Wizard can be used to set the router up as a *server* that accepts inbound VPN connections from a VPN server using a LAN-to-LAN VPN tunnel.

### Site-to-Site (LAN-to-LAN)

- A connection between two router's LAN networks.
- Allows employees in branch offices and head office to share the same network resources.

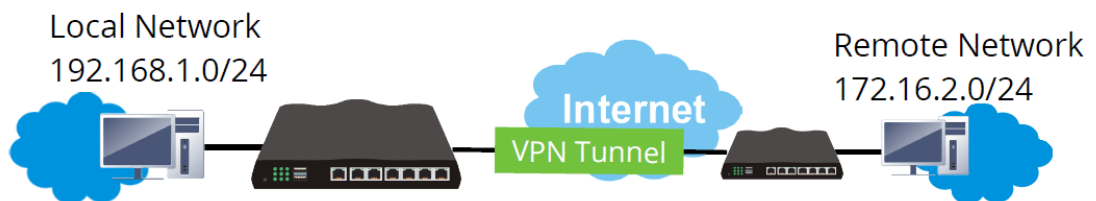

### Remote Access (Remote Dial-in)

- A connection between the remote host and router's LAN network. The host will use an IP address in the local subnet.
- Allows employees to access the company's internal resources when they are traveling.

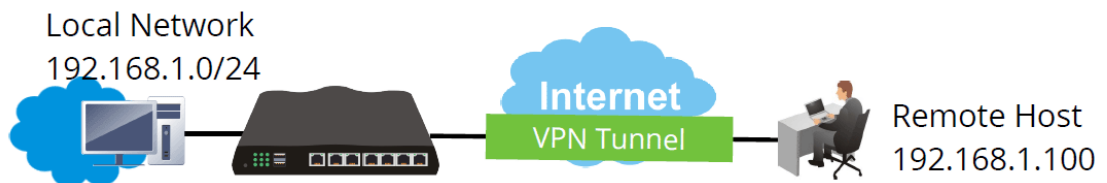



The wizard will guide you step by step through the setup process.

1. On the menu bar, click on Wizards, and then VPN Server Wizard.

**VPN Server Wizard**

**Choose VPN Establishment Environment**

VPN Server Mode Selection: Site to Site VPN (LAN-to-LAN) ▼

Please choose a LAN-to-LAN Profile: [Index] [Status] [Name] ▼

Please choose a Dial-in User Accounts: [Index] [Status] [Name] ▼

Allowed Dial-in Type:

- PPTP
- IPsec
- IPsec XAuth
- L2TP with IPsec Policy None ▼
- SSL Tunnel
- OpenVPN Tunnel

< Back
Next >
Finish
Cancel

Available settings are explained as follows:

Item	Description
VPN Server Mode Selection	Type of VPN Server to be configured. Site to Site VPN (LAN-to-LAN) - Configures the VPN server for inbound connections from other routers. Remote Dial-in User (Teleworker) - Configures VPN server for inbound connections from remote users.
Please choose a LAN-to-LAN Profile	If the VPN Server Mode selected was Site to Site VPN (LAN-to-LAN), choose a LAN-to-LAN profile to store this configuration.
Please choose a Dial-in User Accounts	If the VPN Server Mode selected was Remote Dial-in User (Teleworker), choose a Dial-in user profile to store this configuration.
Allowed Dial-in Type	Select all VPN protocols that are allowed for this LAN-to-LAN Profile or Dial-in User Account. Different Dial-in Type will lead to different configuration page. In addition, adjustable items for each dial-in type will be changed according to the VPN Server Mode (Site to Site VPN and Remote Dial-in User) selected.

2. After making the choices for the server profile, please click Next.
3. The following dialog box appears, reminding you to not configure IPsec fields if the remote location has a dynamic IP address.

192.168.1.1

If you are using IPsec Main mode and the remote VPN gateway has a dynamic IP address, please don't setup " PeerIP" or "Peer ID" fields, and don't tick "IPsec Authentication". Instead, please go to the VPN and Remote Access >> IPsec General Setup page to setup a common preshared key.

確定

Click OK to dismiss the dialog box and proceed to the next page.

If you have chosen to configure a LAN-to-LAN VPN profile, proceed to step 4.

If you have chosen to configure a Remote Dial-in User VPN profile, proceed to step 5.

4. The Site to Site VPN (LAN-to-LAN) configuration page appears as follows if you have selected PPTP/SSL.

#### VPN Server Wizard

##### VPN Authentication Setting

Profile Name	<input data-bbox="986 1084 1252 1115" type="text" value="???"/>
PPTP / SSL Tunnel Authentication	
Username	<input data-bbox="986 1137 1252 1169" type="text" value="???"/>
Password	<input data-bbox="986 1173 1252 1205" type="password"/>
Peer IP/VPN Client IP	<input data-bbox="986 1209 1252 1240" type="text"/>
Site to Site Information	
Remote Network IP	<input data-bbox="986 1263 1252 1294" type="text" value="0.0.0.0"/>
Remote Network Mask	<input data-bbox="986 1299 1252 1330" type="text" value="255.255.255.0 / 24"/>
Local Network IP	<input data-bbox="986 1335 1252 1366" type="text" value="192.168.1.1"/>
Local Network Mask	<input data-bbox="986 1370 1252 1402" type="text" value="255.255.255.0 / 24"/>

< Back

Next >

Finish

Cancel

If you have selected PPTP & IPsec & L2TP (three types) or PPTP & IPsec (two types) or L2TP with Policy (Nice to Have/Must), the following configuration screen appears.

VPN Server Wizard

VPN Authentication Setting

Profile Name	???
PPTP / IPsec / L2TP with IPsec Authentication	
Username	???
Password	
<input checked="" type="checkbox"/> Pre-Shared Key	
Confirm Pre-Shared Key	
<input type="checkbox"/> Digital Signature (X.509)	
Peer ID	None
Local ID	
<input checked="" type="radio"/> Alternative Subject Name First	
<input type="radio"/> Subject Name First	
Peer IP/VPN Client IP	
Peer ID	
Site to Site Information	
Remote Network IP	0.0.0.0
Remote Network Mask	255.255.255.0 / 24
Local Network IP	192.168.1.1
Local Network Mask	255.255.255.0 / 24

< Back    Next >    Finish    Cancel

If you have selected IPsec, the following configuration screen appears.

VPN Server Wizard

VPN Authentication Setting

Profile Name	???
IPsec Authentication	
<input checked="" type="checkbox"/> Pre-Shared Key	
Confirm Pre-Shared Key	
<input type="checkbox"/> Digital Signature (X.509)	
Peer ID	None
Local ID	
<input checked="" type="radio"/> Alternative Subject Name First	
<input type="radio"/> Subject Name First	
Peer IP/VPN Client IP	
Peer ID	
Site to Site Information	
Remote Network IP	0.0.0.0
Remote Network Mask	255.255.255.0 / 24
Local Network IP	192.168.1.1
Local Network Mask	255.255.255.0 / 24

< Back    Next >    Finish    Cancel

If you have selected OpenVPN, the following configuration screen appears.

## VPN Server Wizard

### VPN Authentication Setting

Profile Name	???
OpenVPN Tunnel Authentication	
Username	???
Password	Max: 128 characters
Peer IP/VPN Client IP	
Site to Site Information	
Remote Network IP	0.0.0.0
Remote Network Mask	255.255.255.0 / 24
Local Network IP	192.168.1.1
Local Network Mask	255.255.255.0 / 24

### OpenVPN General Setup

<b>Certificates Setup</b>		
Generated certificates	Root Certificate:	None
	Server Certificate:	None
	Client Certificate:	None
	Trust Certificate:	None
	<input type="button" value="Generate"/>	
<b>Note:</b>		
OpenVPN authentication is based on certificates. You may either generate new (by clicking "Generate" button) or upload existing certificates to the following path:		
1. Upload Server Certificate to <a href="#">Certificate Management &gt;&gt; Local Certificate</a>		
2. Upload Trusted Certificate to <a href="#">Certificate Management &gt;&gt; Trusted CA Certificate</a>		

Available settings are explained as follows:

Item	Description
Profile Name	Name to identify this VPN profile.
User Name	Used by the remote LAN to establish a VPN connection. The length of the user name is limited to 11 characters.
Password	Used by the remote LAN to establish a VPN connection. The length of the password is limited to 11 characters.
<b>IPsec / IPsec XAuth / L2TP with IPsec / SSL Tunnel Authentication</b>	
Pre-Shared Key	For PPTP / IPsec / IPsec XAuth / L2TP with IPsec / SSL Tunnel authentication, you have to configure a pre-shared key and/or digital signature.  Note that, if the remote client has a dynamic IP address, do not enable any of the settings (PSK / Digital Signature) in this section. Instead, configure the global IPsec settings by using VPN and Remote Access>>IPsec General Setup.  Pre-Shared Key - Select to enter an IPsec Pre-shared Key specific to this profile. The length of the PSK is limited to 64 characters.

	Confirm Pre-Shared Key - Re-enter the Pre-shared Key again to confirm.
Digital Signature (X.509)	Digital Signature (X.509) - Select to enable X.509 digital signature. Peer ID - Select a predefined X.509 digital signature as the Peer ID. Peer IDs must be configured first using VPN and Remote Access>>IPsec Peer Identity. Local ID - Specifies whether the Subject Name or the Alternative Subject Name of the X.509 Peer ID is to be checked first. Select either Alternative Subject Name First or Subject Name First.
Peer IP/VPN Client IP	Enter the WAN IP address or VPN client IP address for the remote client. If values are specified, only connections coming from the specified IP address and/or having the specified Peer ID will be accepted.
Peer ID	Enter the ID name for the remote client. The maximum length of the peer ID is 47 characters. If the values are specified, only connections coming from the specified IP address and/or having the specified Peer ID will be accepted.
<b>Site to Site Information</b>	
Remote Network IP	Enter the IP address of the remote network.
Remote Network Mask	Enter the subnet mask of the remote network.
Local Network IP	Enter the local network IP for TCP / IP configuration.
Local Network Mask	Enter the local network mask for TCP / IP configuration.
OpenVPN General Setup	Generate - Click to generate certificate for OpenVPN authentication. Or upload an existing certificate from Local Certificate or Trusted CA Certificate page.

5. The Remote Dial-in User (Teleworker) VPN configuration page appears as follows if you have selected PPTP/SSL.

VPN Server Wizard

VPN Authentication Setting

PPTP / SSL Tunnel Authentication	
Username	<input data-bbox="963 1552 1233 1581" type="text" value="???"/>
Password	<input data-bbox="963 1585 1233 1615" type="text" value="Max: 128 characters"/>
Peer IP/VPN Client IP	<input data-bbox="963 1619 1233 1648" type="text"/>
Subnet	<input data-bbox="963 1653 1046 1682" type="text" value="LAN 1"/>

If you have selected IPsec XAuth/L2TP with IPsec Policy (None), the following configuration screen appears.

VPN Server Wizard

VPN Authentication Setting

IPsec XAuth / L2TP with IPsec Authentication	
Username	???
Password	Max: 128 characters
<input checked="" type="checkbox"/> Pre-Shared Key	
Confirm Pre-Shared Key	
Peer IP/VPN Client IP	
Peer ID	
Subnet	LAN 1 ▾

< Back    Next >    Finish    Cancel

If you have selected IPsec XAuth/L2TP with IPsec Policy (Nice to Have)/L2TP with IPsec Policy (Must), the following configuration screen appears.

VPN Server Wizard

VPN Authentication Setting

IPsec XAuth / L2TP with IPsec Authentication	
Username	???
Password	Max: 128 characters
<input checked="" type="checkbox"/> Pre-Shared Key	
Confirm Pre-Shared Key	
<input type="checkbox"/> Digital Signature (X.509)	
Peer ID	None ▾
Peer IP/VPN Client IP	
Peer ID	
Subnet	LAN 1 ▾

< Back    Next >    Finish    Cancel

If you have selected OpenVPN Tunnel, the following configuration screen appears.

**VPN Server Wizard**

**VPN Authentication Setting**

OpenVPN Tunnel Authentication	
Username	<input data-bbox="1018 383 1302 412" type="text" value="???"/>
Password	<input data-bbox="1018 416 1302 445" type="text" value="Max: 128 characters"/>
Peer IP/VPN Client IP	<input data-bbox="1018 450 1302 479" type="text"/>
Subnet	<input data-bbox="1018 483 1106 512" type="text" value="LAN 1"/>

**OpenVPN General Setup**

<b>Certificates Setup</b>		
Generated certificates	Root Certificate:	None
	Server Certificate:	None
	Client Certificate:	None
	Trust Certificate:	None
	<input data-bbox="743 1084 842 1113" type="button" value="Generate"/>	
<b>Note:</b>		
OpenVPN authentication is based on certificates.		
You may either generate new (by clicking "Generate" button) or upload existing certificates to the following path:		
1. Upload Server Certificate to <a href="#">Certificate Management &gt;&gt; Local Certificate</a> .		
2. Upload Trusted Certificate to <a href="#">Certificate Management &gt;&gt; Trusted CA Certificate</a> .		

Available settings are explained as follows:

Item	Description
User Name	Used by the remote LAN to establish a VPN connection. The length of the user name is limited to 11 characters.
Password	Used by the remote LAN to establish a VPN connection. The length of the password is limited to 11 characters.
<b>IKEv1/IKEv2 / IPsec XAuth / L2TP with IPsec /SSL Tunnel Authentication</b>	
Pre-Shared Key	For IKEv1/IKEv2 / IPsec / IPsec XAuth / L2TP with IPsec / SSL Tunnel authentication, you have to configure a pre-shared key and/or digital signature.  Note that, if the remote client has a dynamic IP address, do not enable any of the settings (PSK / Digital Signature) in this section. Instead, configure the global IPsec settings by using VPN and Remote Access>>IPsec General Setup.  Pre-Shared Key - Select to enter an IPsec Pre-shared Key specific to this profile. The length of the PSK is limited to 64

	characters. Confirm Pre-Shared Key - Re-enter the Pre-shared Key again to confirm.
Digital Signature (X.509)	Digital Signature (X.509) - Select to enable X.509 digital signature. Peer ID - Select a predefined X.509 digital signature as the Peer ID. Peer IDs must be configured first using VPN and Remote Access>>IPsec Peer Identity.
Peer IP/VPN Client IP	Enter the WAN IP address or VPN client IP address for the remote client. If values are specified, only connections coming from the specified IP address and/or having the specified Peer ID will be accepted.
Peer ID	Enter the ID name for the remote client. The maximum length of the peer ID is 47 characters. If the values are specified, only connections coming from the specified IP address and/or having the specified Peer ID will be accepted.
Subnet	Select an interface.
OpenVPN General Setup	Generate - Click to generate certificate for OpenVPN authentication. Or upload existing certificates from Local Certificate or Trusted CA Certificate page.

6. After finishing the configuration, click Next to proceed to the confirmation page.

#### VPN Server Wizard

##### Please Confirm Your Settings

VPN Environment:	Site to Site VPN (LAN-to-LAN)
Index:	1
Profile Name:	test
Username:	ppendss
Allowed Service:	IPsec XAuth+L2TP+L2TP with IPsec Policy
Peer IP/VPN Client IP:	172.16.3.99
Peer ID:	testfor
Remote Network IP:	172.16.3.190
Remote Network Mask:	255.255.255.0
Local Network IP:	192.168.1.1
Local Network Mask:	255.255.255.0

Click **Back** to modify changes if necessary. Otherwise, click **Finish** to save the current settings and proceed to the following action:

Go to the VPN Connection Management.  
 Do another VPN Server Wizard setup.  
 View more detailed configurations.

Available settings are explained as follows:

Item	Description
Go to the VPN Connection	Proceed to VPN and Remote Access>>Connection Management to manage VPN sessions.



Management	
Do another VPN Server Wizard Setup	Rerun the VPN Server Wizard to configure another LAN-to-LAN VPN profile.
View more detailed configuration	Open this profile in VPN and Remote Access>>LAN to LAN to make additional configuration changes.

7. Click Finish to save the profile, or Back to make changes, or Cancel to exit the wizard without saving.

## V-1-3 Remote Access Control

The Vigor router supports several protocols for VPNs, all of which can be enabled or disabled independently of one another.

If you intend to run a VPN server inside your LAN, you should disable the VPN service of Vigor Router to allow VPN tunnel pass through, as well as the appropriate NAT settings, such as DMZ or open port. Open VPN and Remote Access>>Remote Access Control.

### VPN and Remote Access >> Remote Access Control Setup

#### Remote Access Control Setup

<input checked="" type="checkbox"/> Enable PPTP VPN Service <input checked="" type="checkbox"/> Enable IPsec VPN Service <input checked="" type="checkbox"/> Enable L2TP VPN Service <input checked="" type="checkbox"/> Enable SSL VPN Service <input checked="" type="checkbox"/> Enable OpenVPN Service
--

**Note:**

To allow VPN pass-through to a separate VPN server on the LAN, disable any services above that use the same protocol and ensure that NAT [Open Ports](#) or [Port Redirection](#) is also configured.

Item	Description
Enable PPTP VPN Service	This is the one of the earliest VPN protocols and is natively supported by all Microsoft Windows versions since Windows 95, all Android devices, iOS devices before version 10, and Mac OS X before version 10.12. It is easy to set up, has low overhead, and moderately secure.
Enable IPsec VPN Service	This is a network protocol that encrypts traffic between two network locations. Windows, by means of Windows Firewall, natively supports IPsec tunnels between endpoints with static IP addresses. For computers with dynamically-assigned IP addresses, DrayTek provides the SmartVPN client .
Enable L2TP VPN Service	This is a tunneling protocol used in VPNs. It does not encrypt network traffic unless used in conjunction with IPsec.
Enable SSL VPN Service	This type of VPN uses Secure Sockets Layer (SSL) and Transport Layer Security (TLS), which are also used to encrypt traffic to and from websites. Since SSL and TLS work on top of TCP and UDP, which are the most common internet protocols, they are less likely to be have issues with firewalls and gateways.
Enable OpenVPN Service	This type of VPN offers a convenient way for users to build VPN between local end and remote end.

To save changes on the page, select OK; to discard changes, select Cancel; to clear settings on this page and revert to default settings, select Clear.

## V-1-4 PPP General Setup

This page allows configuration of Point-to-Point Protocol (PPP) used by PPTP and L2TP VPN connections. From the Main Menu select VPN and Remote Access >> PPP General Setup to bring up the following configuration page.

VPN and Remote Access >> PPP General Setup

**PPP General Setup**

<p><b>PPP/MP Protocol</b></p> <p>Dial-In PPP Authentication <input type="text" value="PAP/CHAP/MS-CHAP/MS-CHAPv2"/></p> <p>Dial-In PPP Encryption(MPPE) <input type="text" value="Optional MPPE"/></p> <p>Mutual Authentication (PAP) <input type="radio"/> Yes <input checked="" type="radio"/> No</p> <p>Username <input type="text" value="Max: 128 characters"/></p> <p>Password <input type="text" value="Max: 128 characters"/></p> <p><b>IP Address Assignment for Dial-In Users when DHCP is disabled.</b></p> <table border="1"> <thead> <tr> <th></th> <th>Start IP Address</th> <th>IP Pool Counts</th> </tr> </thead> <tbody> <tr><td>LAN 1</td><td><input type="text" value="192.168.1.200"/></td><td><input type="text" value="50"/></td></tr> <tr><td>LAN 2</td><td><input type="text" value="192.168.2.200"/></td><td><input type="text" value="50"/></td></tr> <tr><td>LAN 3</td><td><input type="text" value="192.168.3.200"/></td><td><input type="text" value="50"/></td></tr> <tr><td>LAN 4</td><td><input type="text" value="192.168.4.200"/></td><td><input type="text" value="50"/></td></tr> <tr><td>LAN 5</td><td><input type="text" value="192.168.5.200"/></td><td><input type="text" value="50"/></td></tr> <tr><td>LAN 6</td><td><input type="text" value="192.168.6.200"/></td><td><input type="text" value="50"/></td></tr> <tr><td>LAN 7</td><td><input type="text" value="192.168.7.200"/></td><td><input type="text" value="50"/></td></tr> <tr><td>LAN 8</td><td><input type="text" value="192.168.8.200"/></td><td><input type="text" value="50"/></td></tr> <tr><td>DMZ</td><td><input type="text" value="192.168.254.200"/></td><td><input type="text" value="50"/></td></tr> </tbody> </table>		Start IP Address	IP Pool Counts	LAN 1	<input type="text" value="192.168.1.200"/>	<input type="text" value="50"/>	LAN 2	<input type="text" value="192.168.2.200"/>	<input type="text" value="50"/>	LAN 3	<input type="text" value="192.168.3.200"/>	<input type="text" value="50"/>	LAN 4	<input type="text" value="192.168.4.200"/>	<input type="text" value="50"/>	LAN 5	<input type="text" value="192.168.5.200"/>	<input type="text" value="50"/>	LAN 6	<input type="text" value="192.168.6.200"/>	<input type="text" value="50"/>	LAN 7	<input type="text" value="192.168.7.200"/>	<input type="text" value="50"/>	LAN 8	<input type="text" value="192.168.8.200"/>	<input type="text" value="50"/>	DMZ	<input type="text" value="192.168.254.200"/>	<input type="text" value="50"/>	<p><b>PPP Authentication Methods</b></p> <p><input checked="" type="checkbox"/> Remote Dial-in User</p> <p><input checked="" type="checkbox"/> RADIUS</p> <p><input checked="" type="checkbox"/> AD/LDAP</p> <p><b>LDAP Profile</b></p> <p><input checked="" type="checkbox"/> TACACS+</p> <p><b>VPN TCP maximum segment size (MSS)</b></p> <p>PPTP <input type="text" value="1360"/> (512~1412)</p> <p>L2TP <input type="text" value="1360"/> (512~1408)</p> <p>SSL <input type="text" value="1260"/> (512~1360)</p> <p><b>Note:</b></p> <ol style="list-style-type: none"> <li>1. Please select 'PAP Only' 'Dial-In PPP Authentication', if you want to use AD/LDAP or TACACS+ for PPP Authentication.</li> <li>2. Default priority is Remote Dial-in User -&gt; RADIUS -&gt; AD/LDAP -&gt; TACACS+.</li> <li>3. Vigor router also supports Framed-IP-Address from RADIUS server to assign IP address to VPN client.</li> </ol> <p><b>While using RADIUS or LDAP authentications:</b></p> <p>Assign IP from subnet: <input type="text" value="LAN1"/></p>
	Start IP Address	IP Pool Counts																													
LAN 1	<input type="text" value="192.168.1.200"/>	<input type="text" value="50"/>																													
LAN 2	<input type="text" value="192.168.2.200"/>	<input type="text" value="50"/>																													
LAN 3	<input type="text" value="192.168.3.200"/>	<input type="text" value="50"/>																													
LAN 4	<input type="text" value="192.168.4.200"/>	<input type="text" value="50"/>																													
LAN 5	<input type="text" value="192.168.5.200"/>	<input type="text" value="50"/>																													
LAN 6	<input type="text" value="192.168.6.200"/>	<input type="text" value="50"/>																													
LAN 7	<input type="text" value="192.168.7.200"/>	<input type="text" value="50"/>																													
LAN 8	<input type="text" value="192.168.8.200"/>	<input type="text" value="50"/>																													
DMZ	<input type="text" value="192.168.254.200"/>	<input type="text" value="50"/>																													

OK

Available settings are explained as follows:

Item	Description
Dial-In PPP Authentication	<p>PAP Only - Authenticate dial-in users using the PAP protocol only.</p> <p>PAP/CHAP/MS-CHAP/MS-CHAPv2 - Attempt to authenticate dial-in users using various CHAP protocols, and if the remote VPN client fails to authenticate, fall back to PAP.</p>
Dial-In PPP Encryption (MPPE)	<p>Specifies if PPP encryption (MPPE) is to be used for dial-in VPN connections.</p> <p>Optional MPPE - MPPE is optional. If the VPN client supports MPPE, PPP data will be encrypted.</p> <p>Require MPPE (40/128bits) - Require PPP encryption for dial-in VPN connections. Both 40- and 128-bit encryption schemes are allowed. The remote dial-in user will use 40-bit to perform encryption prior to using 128-bit for encryption. In other words, if 128-bit MPPE encryption method is not available, then 40-bit encryption scheme will be applied to encrypt the data.</p> <p>Maximum MPPE - Require 128-bit PPP encryption for all dial-in VPN connections.</p>
Mutual Authentication (PAP)	<p>Specifies if mutual authentication is to be used. Some VPN peers (e.g., certain Cisco routers) require bi-directional</p>

	<p>authentication used for providing stronger security.</p> <p>When mutual authentication is enabled, Username and Password fields should also be populated using values from the VPN peer. The maximum lengths of these fields are 23 and 19 characters, respectively.</p> <p>Yes - Enable mutual authentication. No - Disable mutual authentication.</p>
IP Address Assignment for Dial-In Users when DHCP is disabled	<p>LAN1 - When the router's DHCP server is disabled, the router will assign IP addresses to dial-in VPN users starting with the IP address specified in Start IP Address. The total number of dial-in VPN IP addresses to be given out is specified in IP Pool Counts.</p> <p>LAN2 - LAN8 and DMZ will be available if it is enabled. Refer to LAN&gt;&gt;General Setup for enabling the LAN interface.</p>
PPP Authentication Methods	<p>The credentials to be used for PPP authentication will be obtained from the selected sources, in the following order:</p> <p>Remote Dial-in User - The usernames and passwords in VPN and Remote Access &gt;&gt; Remote Dial-in User section will be used.</p> <p>RADIUS - An external RADIUS server is to be used for authentication. Please be sure to set up the RADIUS server in Applications &gt;&gt; RADIUS/TACACS+ section.</p> <p>AD/LDAP - An Active Directory/LDAP server is to be used for authentication. Please be sure to configure AD and LDAP settings in Applications &gt;&gt; Active Directory/LDAP.</p> <p>TACACS+ - A TACACS+ server is to be used for authentication. Please be sure to set up the RADIUS server in Applications &gt;&gt; RADIUS/TACACS+ section.</p>
PPTP LDAP Profile	<p>Configured LDAP profiles will be listed under such item. Simply check the one you want to enable the PPP authentication by LDAP server profiles.</p> <p>However, if there is no profile listed, simply click the link of PPTP LDAP Profile to create/add some new LDAP profiles you want.</p>
VPN TCP maximum segment size (MSS)	<p>Set the maximum segment size (MSS) for different VPN types. Please specify the MSS values for each type to avoid packets cut by MTU during the data transmission period via the IPsec VPN connection.</p>
While using Radius or LDAP Authentication	<p>When the dial-in VPN user is authenticated using credentials from the Remote Dial-in User section, an IP address from the LAN specified in the user profile will be assigned. When the user is authenticated using credentials from other sources (RADIUS, AD, TACACS+), the assigned IP address will be drawn from the address pool of the LAN specified here.</p>

To save changes on the page, select OK.

---

## V-1-5 SSL General Setup

SSL VPN (Secure Sockets Layer virtual private network) is a form of VPN that encrypts traffic using SSL, which is the same technology used on secured websites. Because of SSL's prominence as an encryption protocol on the Internet, most networks have few restrictions on SSL traffic, and as a result SSL VPN is more likely to work when other VPN technologies experience difficulties due to obstacles such as firewalls and Network Address Translation (NAT).

In short,

- It is not necessary for users to preinstall VPN client software for executing SSL VPN connection.
- There are less restrictions for the data encrypted through SSL VPN in comparing with traditional VPN.

This page determines the general configuration for SSL VPN Server and SSL Tunnel.

---

VPN and Remote Access >> SSL General Setup

---

### SSL General Setup

Bind to WAN	<input checked="" type="checkbox"/> WAN1
	<input checked="" type="checkbox"/> WAN2
	<input checked="" type="checkbox"/> WAN3
	<input checked="" type="checkbox"/> WAN4
	<input checked="" type="checkbox"/> WAN5
	<input checked="" type="checkbox"/> WAN6
Port	<input type="text" value="443"/> (Default: 443)
Server Certificate	<input type="text" value="self-signed"/> ▼

or

---

VPN and Remote Access >> SSL General Setup

---

### SSL General Setup

Bind to WAN	<input checked="" type="checkbox"/> WAN1
	<input checked="" type="checkbox"/> WAN2
	<input checked="" type="checkbox"/> WAN3
	<input checked="" type="checkbox"/> WAN4
	<input checked="" type="checkbox"/> LTE
	<input checked="" type="checkbox"/> WAN6
Port	<input type="text" value="443"/> (Default: 443)
Server Certificate	<input type="text" value="self-signed"/> ▼

Or

VPN and Remote Access >> SSL General Setup

SSL General Setup

Bind to WAN	<input checked="" type="checkbox"/> WAN1 <input checked="" type="checkbox"/> WAN2 <input checked="" type="checkbox"/> WAN5 <input checked="" type="checkbox"/> WAN6
Port	<input type="text" value="443"/> (Default: 443)
Server Certificate	<input type="text" value="self-signed"/> ▼

Available settings are explained as follows:

Item	Description
Bind to WAN	Select the WAN interfaces to accept inbound SSL VPN connections.
Port	The port to be used for SSL VPN server. This is separate from the management port (HTTPS Port) which is configured in <b>System Maintenance&gt;&gt;Management</b> . The default setting is 443.
Server Certificate	Specify the certificate to be used for SSL connections. Select a certificate from imported or generated certificates on the router, or choose Self-signed to use the router's built-in default certificate. The selected certificate can be used in SSL VPN server and HTTPS Web Proxy.

To save changes on this page, select OK; to discard changes, select Cancel.

---

## V-1-6 IPsec General Setup

In IPsec General Setup, there are two major parts of configuration.

There are two phases of IPsec.

- Phase 1: negotiation of IKE parameters including encryption, hash, Diffie-Hellman parameter values, and lifetime to protect the following IKE exchange, authentication of both peers using either a Pre-Shared Key or Digital Signature (x.509). The peer that starts the negotiation proposes all its policies to the remote peer and then remote peer tries to find a highest-priority match with its policies. Eventually to set up a secure tunnel for IKE Phase 2.
- Phase 2: negotiation IPsec security methods including Authentication Header (AH) or Encapsulating Security Payload (ESP) for the following IKE exchange and mutual examination of the secure tunnel establishment.

There are two encapsulation methods used in IPsec, Transport and Tunnel. The Transport mode will add the AH/ESP payload and use original IP header to encapsulate the data payload only. It can just apply to local packet, e.g., L2TP over IPsec. The Tunnel mode will not only add the AH/ESP payload but also use a new IP header (Tunneled IP header) to encapsulate the whole original IP packet.

AH (Authentication Header) provides data authentication and integrity for IP packets passed between VPN peers. This is achieved by a keyed one-way hash function to the packet to create a message digest. This digest will be put in the AH and transmitted along with packets. On the receiving side, the peer will perform the same one-way hash on the packet and compare the value with the one in the AH it receives.

ESP (Encapsulating Security Payload) is a security protocol that provides data confidentiality and protection with optional authentication and replay detection service.

**VPN IKE/IPsec General Setup**

(Dial-in settings for Remote Dial-In users and LAN-to-LAN VPN Client with Dynamic IP.)

<b>IKE Authentication Method</b>	
Certificate	None ▼
Preferred Local ID	Alternative Subject Name ▼
General Pre-Shared Key	Max: 128 characters
Confirm General Pre-Shared Key	Max: 128 characters
XAuth User Pre-Shared Key	Max: 63 characters
Confirm XAuth User Pre-Shared Key	Max: 63 characters
<b>IPsec Security Method</b>	
<input type="radio"/> Basic <input type="radio"/> Medium <input type="radio"/> High	Encryption: AES/3DES/DES HMAC: SHA256/SHA1 DH Group: G21/G20/G19/G14/G5/G2/G1 AH: <input checked="" type="checkbox"/> Enable
<b>VPN TCP maximum segment size (MSS)</b>	
IPsec (IKEv1/IKEv2)	1360 (512~1381)
L2TP over IPsec	1360 (512~1361)
GRE over IPsec	1360 (512~1365)

OK Cancel

Available settings are explained as follows:

Item	Description
IKE Authentication Method	<p>This usually applies to those are remote dial-in user or node (LAN-to-LAN) which uses dynamic IP address and IPsec-related VPN connections such as L2TP over IPsec and IPsec tunnel. There are two methods offered by Vigor router for you to authenticate the incoming data coming from remote dial-in user, Certificate (X.509) and Pre-Shared Key.</p> <p>Certificate - X.509 certificates can be used for IKE authentication. To set up certificates on the router, go to the Certificate Management section.</p> <p>Preferred Local ID - Specify the preferred local ID information (Alternative Subject Name First or Subject Name First) for IPsec authentication while the client is using the general setting (without a specific Peer IP or ID in the VPN profile).</p> <p>General Pre-Shared Key- Define the PSK key for general authentication.</p> <p>Confirm General Pre-Shared Key- Re-enter the characters to confirm the pre-shared key.</p> <p>XAuth User Pre-Shared Key - Define the PSK key for IPsec XAuth authentication.</p> <p>Confirm XAuth User Pre-Shared Key- Re-enter the characters to confirm the pre-shared key for IPsec XAuth</p>



	<p>authentication.</p> <p>Note: Any packets from the remote dial-in user which does not match the rule defined in VPN and Remote Access&gt;&gt;Remote Dial-In User will be applied with the method specified here.</p>
IPsec Security Method	<p>Available methods include Basic, Medium and High. Each method offers different encryption, HMAC and DH Group.</p> <p>Basic - Authentication Header (AH) means data will be authenticated, but not be encrypted. By default, this option is active.</p> <p>Medium - When this option is selected, the Authentication Header (AH) protocol can be used to provide authentication to IPsec traffic.</p> <p>High - When this option is selected, the Encapsulating Security Payload (ESP) protocol can be used to provide authentication and encryption to IPsec traffic. Three encryption standards are supported for ESP: DES, 3DES and AES, in ascending order of security.</p>
VPN TCP maximum segment size (MSS)	<p>Set the maximum segment size (MSS) for different VPN types. Please specify the MSS values for each type to avoid packets cut by MTU during the data transmission period via the IPsec VPN connection.</p>

To save changes on the page, select OK; to discard changes, select Cancel.

## V-1-7 IPsec Peer Identity

This screen allows creating profiles of subject alternative names (SANs) and distinguished names/subject names that can be used for IPsec peer authentication in LAN-to-LAN or remote user dial-in VPN connections.

VPN and Remote Access >> IPsec Peer Identity

X509 Peer ID Accounts: | [Set to Factory Default](#) |

Index	Enable	Name	Index	Enable	Name
<u>1.</u>	<input type="checkbox"/>	???	<u>17.</u>	<input type="checkbox"/>	???
<u>2.</u>	<input type="checkbox"/>	???	<u>18.</u>	<input type="checkbox"/>	???
<u>3.</u>	<input type="checkbox"/>	???	<u>19.</u>	<input type="checkbox"/>	???
<u>4.</u>	<input type="checkbox"/>	???	<u>20.</u>	<input type="checkbox"/>	???
<u>5.</u>	<input type="checkbox"/>	???	<u>21.</u>	<input type="checkbox"/>	???
<u>6.</u>	<input type="checkbox"/>	???	<u>22.</u>	<input type="checkbox"/>	???
<u>7.</u>	<input type="checkbox"/>	???	<u>23.</u>	<input type="checkbox"/>	???
<u>8.</u>	<input type="checkbox"/>	???	<u>24.</u>	<input type="checkbox"/>	???
<u>9.</u>	<input type="checkbox"/>	???	<u>25.</u>	<input type="checkbox"/>	???
<u>10.</u>	<input type="checkbox"/>	???	<u>26.</u>	<input type="checkbox"/>	???
<u>11.</u>	<input type="checkbox"/>	???	<u>27.</u>	<input type="checkbox"/>	???
<u>12.</u>	<input type="checkbox"/>	???	<u>28.</u>	<input type="checkbox"/>	???
<u>13.</u>	<input type="checkbox"/>	???	<u>29.</u>	<input type="checkbox"/>	???
<u>14.</u>	<input type="checkbox"/>	???	<u>30.</u>	<input type="checkbox"/>	???
<u>15.</u>	<input type="checkbox"/>	???	<u>31.</u>	<input type="checkbox"/>	???
<u>16.</u>	<input type="checkbox"/>	???	<u>32.</u>	<input type="checkbox"/>	???

<< [1-32](#) | [33-64](#) >> [Next](#) >>

Available settings are explained as follows:

Item	Description
Set to Factory Default	Click it to clear all indexes.
Index	Click the index number of the profile the view or edit its settings.
Enable	Check to enable the profile.
Name	User-entered name that identifies the profile.

The following setup screen is shown after a profile index has been clicked.

VPN and Remote Access >> IPsec Peer Identity

Profile Index : 1

Enable this account

Profile Name

---

Accept Any Peer ID

---

Accept Subject Alternative Name

Type  ▼

IP

---

Accept Subject Name

Country (C)

State (ST)

Location (L)

Organization (O)

Organization Unit (OU)

Common Name (CN)

Email (E)

Available settings are explained as follows:

Item	Description
Enable this account	Check to enable such account profile.
Profile Name	A name that allows you to identify this profile. The maximum length of the name you can set is 32 characters.
Accept Any Peer ID	When this option is selected, the router accepts any subject alternative name or subject name as valid, regardless of the type and value.
Accept Subject Alternative Name	When this option is selected, the router accepts the type and value of the specified subject alternative name as valid authentication. Supported subject alternative types are IP Address, Domain Name and E-Mail.
Accept Subject Name	When this option is selected, the router performs peer authentication by matching the values of the different subject name fields. These fields include Country (C), State (ST), Location (L), Organization (O), Organization Unit (OU), Common Name (CN), and Email (E).

To save changes on the page, select OK; to discard changes, select Cancel; to clear settings on this page and revert to default settings, select Clear.

## V-1-8 VPN Matcher Setup

Normally, to establish VPN connection, at least one peer must have a public IP address. The VPN Matcher server can help two Draytek routers behind NAT establish a secure VPN tunnel for data transmission between each other. Refer to the following figure.

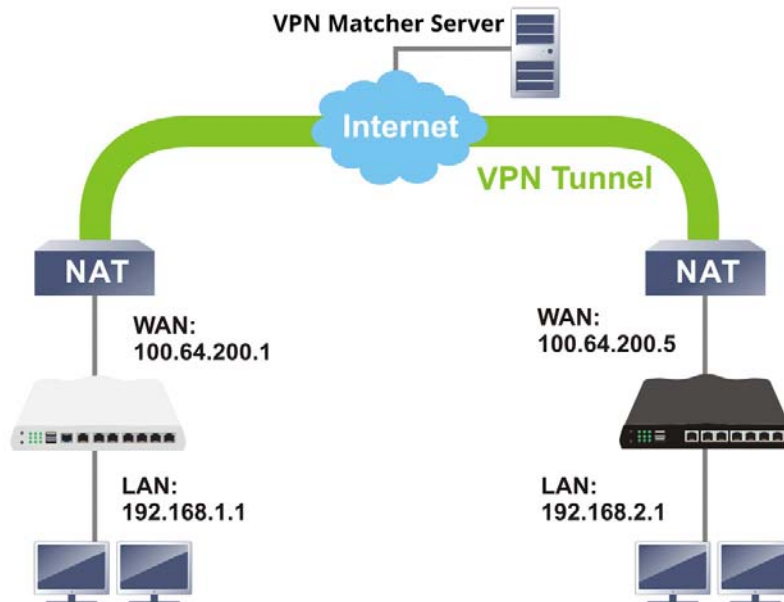

There is one limitation for the VPN connection. Both routers must be behind a cone NAT, but not symmetric NAT.

Go to **VPN and Remote Access >> VPN Matcher Setup** to open the following page.

### VPN and Remote Access >> VPN Matcher Setup

Enable  Disable

VPN Matcher Server:  :

Router List Key:

**Note:** You can get your Router List Key on [VPN Matcher Dashboard](#).

---

NAT Detection

STUN Server

Group Device List

Available settings are explained as follows:

Item	Description
Enable / Disable	Click to enable / disable the function of VPN Matcher Setup.
VPN Matcher Server	The IP address of the DrayTek VPN Matcher server is defined as "vpn-matcher.draytek.com" with the port number "31503".
Router List Key	Enter the authentication key for finding a Vigor router with the same group of this device from the VPN matcher server. Then set a VPN link between Vigor routers on both ends via

	VPN wizard.
OK	Click to save the settings.
STUN Server	Detect - Click to check if the NAT used by Vigor router is core NAT or not. If not, no VPN can be established.
Group Device List	Get List - After entering the Authkey above, click to get available Vigor router which is within the same group as this device.

## V-1-9 OpenVPN

The OpenVPN protocol utilizes public keys, certificates, and usernames and passwords to authenticate the client. Traffic is carried over secure channels built upon industry-standard SSL/TLS encryption protocols.

With integrating of OpenVPN, Vigor router can help users to achieve more robust, reliable and secure private connections for business needs.

OpenVPN offers a convenient way for users to build a VPN between the local end and the remote end. There are two advantages of OpenVPN:

- It can be operated on different systems such as Windows, Linux, and MacOS.
- Based on the standard protocol of SSL encryption, OpenVPN can provide you with a scalable client/server mode, permitting multi-client to connect to a single OpenVPN Server process over a single TCP or UDP port.

In terms of credentials, the administrator can choose to let the router generate the certificates, or import certificates issued by third-party certificate authorities (CAs). When the router generates the certificates, it acts as the root CA to issue the trusted CA certificates (stored under Certificate Management >> Trusted CA Certificate), which are used to generate the server and client certificates used by OpenVPN (stored under Certificate Management >> Local Certificate). If, however, a certificate issued by a third-party CA is used, both the CA's certificate and the issued certificate need to be imported to the router in the Trusted CA Certificate and Local Certificate sections, respectively.

### V-1-9-1 OpenVPN Server Setup

OpenVPN requires the use of certificates. Before establishing OpenVPN connection, general settings for OpenVPN service shall be configured first.

VPN and Remote Access >> OpenVPN



OpenVPN Server Setup	Client Config	Import Certificate
<b>General Setup</b>		
UDP	<input checked="" type="checkbox"/> Enable	
UDP Port	<input type="text" value="1194"/>	
TCP	<input checked="" type="checkbox"/> Enable	
TCP Port	<input type="text" value="1194"/>	
Cipher Algorithm	<input type="text" value="AES256"/>	
HMAC Algorithm	<input type="text" value="SHA256"/>	
Certificate Authentication	<input checked="" type="checkbox"/>	
<b>Certificates Setup</b>		
Certificate Source	<input type="radio"/> Router generated certificates	
	<input checked="" type="radio"/> Uploading certificates to Router	
<b>Trust CA</b>	<input type="text" value="default"/>	
<b>Server Certificate</b>	<input type="text" value="none"/>	

**Note:** OpenVPN on Vigor Router only support TUN device interface currently. So please setup corresponding configurations on the client side.

OK

Available settings are explained as follows:

Item	Description
<b>General Setup</b>	
UDP	<p>Enable - Select checkbox to enable UDP protocol for OpenVPN connections.</p> <p>UDP Port - Enter the UDP port number.</p>
TCP	<p>Enable - Select checkbox to enable TCP protocol for OpenVPN connections.</p> <p>TCP Port - Enter the TCP port number.</p>
Cipher Algorithm	<p>Select the desired cipher algorithm. Two encryption algorithms are supported: AES128 and AES256. AES256 is more secure than AES128 but may result in lower performance because it incurs higher computational overhead.</p>
HMAC Algorithm	<p>HMAC stands for Hash-based Message Authentication Code. It is used to validate the data integrity and authenticity of the VPN data.</p> <p>Select the desired HMAC hash algorithm. Two hash algorithms, SHA1 and SHA256, are supported. SHA256 is preferred as it is more robust and reliable than SHA1.</p>
Certificate Authentication	<p>Select this checkbox if you would like to validate that the client certificate was issued by a trusted CA.</p>
<b>Certificate Setup</b>	
Certificate Source	<p>Select a source for the certificate to be used for OpenVPN.</p> <p>Router generated certificates - Router-generated certificates that will be used for OpenVPN.</p> <ul style="list-style-type: none"> <li>● GENERATE - Click to generate a certificate.</li> <li>● Delete all certificates - Click to remove all certificates generated by the router.</li> </ul> <p>Uploading certificates to Router - Third-party certificates will be used for OpenVPN.</p> <ul style="list-style-type: none"> <li>● Trust CA - Use the dropdown list to select a trusted CA certificate that has already been uploaded to the router. To upload Trusted CA certificates to the router, click the Trust CA link and you will be taken to the Certificate Management &gt;&gt; Trusted CA Certificate page to perform the operation.</li> <li>● Server Certificate - Use the dropdown list to select a server certificate that has already been uploaded to the router. To upload server certificates to the router, click the Server Certificate link and you will be taken to the Certificate Management &gt;&gt; Local Certificate page to perform the operation.</li> </ul>

After finishing all the settings here, please click OK to save the configuration.

## V-1-9-2 Client Config

On this page, you can create and export the configuration required for a remote OpenVPN client to connect to the router.

VPN and Remote Access >> OpenVPN



OpenVPN Server Setup	Client Config	Import Certificate
Remote Server	<input checked="" type="radio"/> IP <input type="radio"/> Domain <input type="radio"/> VPN Matcher	<input type="text" value="WAN2 172.16.3.134"/>
Transport Protocol	<input type="text" value="UDP"/>	
Auto Dial-Out	<input checked="" type="radio"/> Enable <input type="radio"/> Disable	
Set VPN as Default Gateway	<input type="radio"/> Enable <input checked="" type="radio"/> Disable	
Cache password for auto reconnect	<input checked="" type="radio"/> Enable <input type="radio"/> Disable	
UDP Ping	<input type="text" value="10"/>	Seconds(s)
UDP Ping exit	<input type="text" value="60"/>	Seconds(s)
File Name	<input type="text"/> .ovpn	
Client cert	<input type="text"/> .cert	
Client key	<input type="text"/> .key	
Mail Profile	<input type="text" value="1 - ???"/>	<input type="text" value=""/>
Mail Address	<input type="text"/>	
<input type="button" value="Send Email"/>		

Note:

1. Please make sure the Client cert and the Client key are located in the same folder with .ovpn file.
2. Please make sure that WAN can be used as OpenVPN server.
3. Cache password for auto reconnect.  
 Enabled: Cache password in virtual memory for re-authentication to keep VPN always connected.  
 Disabled: Type password manually when re-authentication needed. VPN may disconnect during re-authentication.

Available settings are explained as follows:

Item	Description
Remote Server	<p>The OpenVPN client will use the IP address or domain name to connect to the router. Select either IP or Domain.</p> <p>IP - The OpenVPN configuration file will use the numeric IP address as the server address.</p> <p>Domain - The OpenVPN configuration file will use the domain as the server address. You need to ensure that the domain resolves to the IP address of a router WAN port.</p> <p>VPN matcher - The OpenVPN configuration file will use the VPN matcher as the server address.</p>
Transport Protocol	Select UDP or TCP for the protocol to be used by the OpenVPN client to connect to the router.
Auto Dial-Out	<p>Enable - If selected, the remote client can auto-dial to this Vigor router to build an OpenVPN tunnel.</p> <p>Disable - Select to disable the function.</p>
Set VPN as Default Gateway	<p>Enable - If selected, the Vigor router will be treated as a "default" gateway for OpenVPN clients. The OpenVPN client will redirect all the traffic to the Vigor router via the</p>



	OpenVPN tunnel. Disable - Select to disable the function.
Cache password for auto reconnect	Enable - OpenVPN will reconnect per hour. While reconnecting, the password is required. If the function is enabled, the password for OpenVPN connection will be kept and used by the Vigor system for reconnection every time. Disable - Select to disable the function.
UDP Ping	Ping remote device over the UDP control channel, if no packets have been sent for the number of seconds configured here.
UDP Ping exit	Let OpenVPN exit after the seconds set here if no reception of a ping or other packet from the remote device.
File Name	Enter the filename of the configuration file to be downloaded from the router.
Client cert	Enter the filename of the client certificate obtained from 3rd party provider.
Client key	Enter the filename of the private key obtained from the 3rd party provider.
Mail Profile	Use the drop down list to specify a mail profile. Mail Address - Enter the mail address to receive the notification mail. Send Email - Click to send out the mail.
Export	Click this button to download the settings on this page as a file, which can be imported into a VPN client to establish OpenVPN connections.

### V-1-9-3 Import Certificate

On this page, you can import the certificate from other places for a remote OpenVPN client to connect to the router.

VPN and Remote Access >> OpenVPN ?

---

**OpenVPN Server Setup**   **Client Config**   **Import Certificate**

**Import OpenVPN config file**

**Note:**

1. TLS-auth key won't be deleted even you load the .rst firmware.
2. Please clear the LAN-to-LAN Profile if you want to delete the TLS-auth key.

Select a OpenVPN config file.

未選擇任何檔案

Click [Import](#) to upload the certificate.

---

**Import X509 Local / Trusted CA Certificate**

**Note:**

1. Please setup the "System Maintenance >> [Time and Date](#)" correctly before signing the local/trusted CA certificate.
2. The Time Zone MUST be setup correctly!!

Available settings are explained as follows:

Item	Description
<b>Import OpenVPN config</b>	
Select an OpenVPN config file	Browse - Click to select a file. Import - Click to import a configuration file.
<b>Import X509 Local/Trusted CA Certificate</b>	
Import Local Certificate	Click to access into Local Certificate page for importing a certificate.
Import Trusted CA Certificate	Click to access into Trusted CA Certificate page for importing a certificate.

## V-1-10 Remote Dial-in User

You can manage remote access by maintaining a table of remote user profiles, so that users can be authenticated via VPN connection.

Remote dial-in user profiles can be set up on this screen.

VPN and Remote Access >> Remote Dial-in User



Remote Access User Accounts: | [Set to Factory Default](#) |

View:  All  Online  Offline

Index	Enable	User	Status	Index	Enable	User	Status
<a href="#">1.</a>	<input type="checkbox"/>	???	---	<a href="#">17.</a>	<input type="checkbox"/>	???	---
<a href="#">2.</a>	<input type="checkbox"/>	???	---	<a href="#">18.</a>	<input type="checkbox"/>	???	---
<a href="#">3.</a>	<input type="checkbox"/>	???	---	<a href="#">19.</a>	<input type="checkbox"/>	???	---
<a href="#">4.</a>	<input type="checkbox"/>	???	---	<a href="#">20.</a>	<input type="checkbox"/>	???	---
<a href="#">5.</a>	<input type="checkbox"/>	???	---	<a href="#">21.</a>	<input type="checkbox"/>	???	---
<a href="#">6.</a>	<input type="checkbox"/>	???	---	<a href="#">22.</a>	<input type="checkbox"/>	???	---
<a href="#">7.</a>	<input type="checkbox"/>	???	---	<a href="#">23.</a>	<input type="checkbox"/>	???	---
<a href="#">8.</a>	<input type="checkbox"/>	???	---	<a href="#">24.</a>	<input type="checkbox"/>	???	---
<a href="#">9.</a>	<input type="checkbox"/>	???	---	<a href="#">25.</a>	<input type="checkbox"/>	???	---
<a href="#">10.</a>	<input type="checkbox"/>	???	---	<a href="#">26.</a>	<input type="checkbox"/>	???	---
<a href="#">11.</a>	<input type="checkbox"/>	???	---	<a href="#">27.</a>	<input type="checkbox"/>	???	---
<a href="#">12.</a>	<input type="checkbox"/>	???	---	<a href="#">28.</a>	<input type="checkbox"/>	???	---
<a href="#">13.</a>	<input type="checkbox"/>	???	---	<a href="#">29.</a>	<input type="checkbox"/>	???	---
<a href="#">14.</a>	<input type="checkbox"/>	???	---	<a href="#">30.</a>	<input type="checkbox"/>	???	---
<a href="#">15.</a>	<input type="checkbox"/>	???	---	<a href="#">31.</a>	<input type="checkbox"/>	???	---
<a href="#">16.</a>	<input type="checkbox"/>	???	---	<a href="#">32.</a>	<input type="checkbox"/>	???	---

<< [1-32](#) | [33-64](#) >>

[Next](#) >>

**Note:**

User Accounts need to be added into User Group to enable SSL Portal Login.

OK

Cancel

Backup setting to file: <input type="button" value="Backup"/>	Restore From File: <input type="text" value="選擇檔案"/> 未選擇任何檔案 <input type="button" value="Restore"/>
--	--

Available settings are explained as follows:

Item	Description
Set to Factory Default	Click to clear all remote-dial-in user profiles.
Index	Click the index number of the profile the view or edit its settings.
Enable	Check to enable the user profile.
User	Display the username for the specific dial-in user of the LAN-to-LAN profile. The symbol ??? represents that the profile is empty.
Status	Shows the LAN subnet and IP address assignment method. Example: LAN1-DHCP means that the IP address of the VPN

	<p>connection will be drawn from the DHCP pool of the LAN1 subnet.</p> <p>The color of the status indicates the current state of the profile:</p> <p>Green - Profile is being used by a dial-in VPN connection.</p> <p>Red - Profile is not being used.</p> <p>Black - Profile is disabled.</p>
Backup	Click Backup to save the configuration.
Restore	Click Select to choose a configuration file. Then click Restore to apply the file.

To save changes on the page, select OK; to discard changes, select Cancel.

The following setup screen is shown after a profile index has been clicked.

VPN and Remote Access >> Remote Dial-in User

**Index No. 1**

Enable this Account

Multiple Concurrent Connections Allowed

Idle Timeout  second(s)

**Allowed Dial-In Type**

PPTP

IPsec Tunnel

IKEv1/IKEv2  IKEv2 EAP  IPsec XAuth

L2TP with IPsec Policy

SSL Tunnel

OpenVPN Tunnel

Specify Remote Node

Remote Client IP

or Peer ID

Netbios Naming Packet  Pass  Block

Multicast via VPN  Pass  Block  
(for some IGMP,IP-Camera,DHCP Relay..etc.)

**Subnet**

Assign Static IP Address

**Two-Factor Authentication**

Send Authentication Code via Email

Send Authentication Code via SMS

Time-based One-time Password (TOTP)

Secret

**User Account and Authentication**

Username  Password

Enable Mobile One-Time Passwords(mOTP)

Enable Time-based One-time Password(TOTP)

**IKE Authentication Method**

Pre-Shared Key

Digital Signature(X.509)

**IPsec Security Method**

Medium(AH)

High(ESP)  DES  3DES  AES

Local ID (optional)

**Schedule Profile**

**Notification**

Send Email when VPN is up

**Email Object**

Mail to

Send SMS when VPN is up

**SMS Object**

SMS to

**Note:**

1. Username can not contain characters "\*" and "\".

Available settings are explained as follows:

Item	Description
Enable this account	Select to enable this profile to be used by remote dial-in users.
Multiple Concurrent Connections Allowed	Select to make multiple VPN clients connecting to Vigor device with the same username/password. Idle Timeout - Allowed idle time before the router disconnects the VPN connection. Default timeout value is 300 seconds.
Allowed Dial-In Type	Select all VPN protocols allowed for this profile. For L2TP, specify how IPsec should be applied. Options are: <ul style="list-style-type: none"> <li>None - IPsec cannot be used with L2TP connections.</li> </ul>

	<ul style="list-style-type: none"> <li>● Nice to Have - IPsec is preferred but not mandatory for L2TP connections.</li> <li>● Must - IPsec is required when establish L2TP connections.</li> </ul> <p>Specify Remote Node - The IP address of the remote VPN client (Remote Client IP) or the Peer ID (used in IKE aggressive mode) can be optionally specified. The router will reject the connection if either of these values are entered in the profile but the remote client does not pass the value, or passes the wrong value.</p> <p>Netbios Naming Packet - Specifies whether to allow NetBIOS naming packets to traverse through the VPN tunnel.</p> <ul style="list-style-type: none"> <li>● Pass - Click it to have an inquiry for data transmission between the hosts located on both sides of VPN Tunnel while connecting.</li> <li>● Block - When there is conflict occurred between the hosts on both sides of VPN Tunnel in connecting, such function can block data transmission of Netbios Naming Packet inside the tunnel.</li> </ul> <p>Multicast via VPN - Specifies whether to allow multicast packets to traverse through the VPN tunnel.</p> <ul style="list-style-type: none"> <li>● Pass - Click this button to let multicast packets pass through the router.</li> <li>● Block - This is default setting. Click this button to let multicast packets be blocked by the router.</li> </ul>
Subnet	<p>The VPN client will receive an IP address from the DHCP pool or IP address range specified in IP Address Assignment for Dial-In Users for the selected LAN subnet.</p> <p>Assign Static IP Address - Alternatively, a static IP address can be set by selecting the Assign Static IP Address checkbox.</p> <p>User Name - Used for PPTP, L2TP or SSL Tunnel dial-in type. The length of the name is limited to 23 characters.</p> <p>Password - Used for PPTP, L2TP or SSL Tunnel dial-in type. The length of the password is limited to 19 characters.</p>
Two-Factor Authentication	<p>When a remote dal-in user tries to log in Vigor router from the VPN, he/she has to pass the two-factor authentication.</p> <p>Send Authentication Code via Email - Select to send the authentication code via an e-mail. The e-mail address can be specified in the field of Mail to under the Notification area.</p> <div data-bbox="715 1576 1136 1778" style="border: 1px solid #ccc; padding: 5px;"> <p><b>Notification</b></p> <p><input checked="" type="checkbox"/> Send Email when VPN is up</p> <p><u>Email Object</u> 1 - ??? ▾</p> <p>Mail to <input style="border: 2px solid red;" type="text"/></p> <p><input type="checkbox"/> Send SMS when VPN is up</p> </div> <p>Send Authentication Code via SMS - Select to send the authentication code via an SMS. The telephone number can be specified in the field of SMS to under the Notification area.</p>

**Notification**

Send Email when VPN is up

Email Object 1 - ???

Mail to

Send SMS when VPN is up

SMS Object 1 - ???

SMS to

Time-based One-time Password (TOTP) - Select to display a secret generated by Vigor router.

Regenerate - Click to regenerate a new secret and corresponding QR code.

Reset - Click to clear the secret.

Secret - Displays a 32 digit-secret number generated by Vigor router. Correspondign code also will be shown in this area.

**Send Authentication Code via SMS**

Time-based One-time Password (TOTP)

Regenerate

Reset

Secret J5XU452YMFrgSTtMMZTE2YRSPIYEIY

Copy



Copy - Click to copy the secret.

**User Account and Authentication**

User Name - Used for PPTP, L2TP or SSL Tunnel dial-in type. The length of the name is limited to 23 characters.

Password - Used for PPTP, L2TP or SSL Tunnel dial-in type. The length of the password is limited to 19 characters.

Enable Mobile One-Time Passwords (mOTP) - Select to enable one-time passwords (Mobile-OTP). Enter the PIN Code and Secret. DrayTek's SmartVPN client has built-in support for mOTP. Third-party mOTP clients can be used to generate passwords when using other VPN clients. For more information on mOTP, visit Mobile-OTP's homepage.

- PIN Code - Enter the code for authentication (e.g., 1234).
- Secret - Use the 32 digit-secret number generated by mOTP in the mobile phone (e.g., e759bb6f0e94c7ab4fe6).

Enable Time-based One-time Password (TOTP) - Please make sure the time zone of your router is correct. Then, install Google Authenticator APP on your cell phone. Open the APP to scan the QR code on this page. A one-time password will be shown on your phone.

Enable Advanced Authentication method when login from "WAN"

Time-based One-time Password (TOTP)

Secret: ISQU3CEGNLWIU3DNFAUGY2OMFKU22LKMFTG2ZTLNBRTQWLXJ5FGSOTFJU4GE22V



Validation Code  Verify

Mobile One-Time Password (mOTP)

In the filed of Validation Code, enter the one-time password

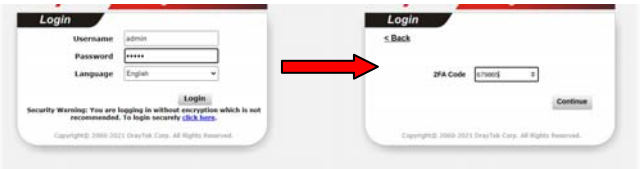
	<p>and click Verify.</p>  <p>Now, the configuration is finished. You will be asked to enter the 2FA code on the after passing the username and password authentication.</p> 
<p><b>IKE Authentication Method</b></p>	<p><b>Pre-Shared Key</b> - This checkbox is available when Remote Client IP or Peer ID is specified. Check the checkbox and click IKE Pre-shared Key to enter an IKE PSK (1-63 characters) that will be used only for this profile.</p> <p><b>Digital Signature (X.509)</b> - To enable authentication using X.509 Peer IDs, check the checkbox then select an X.509 profile. X.509 profiles can be configured in VPN and Remote Access &gt;&gt; IPsec Peer Identity.</p>
<p><b>IPsec Security Method</b></p>	<p>Select all the IPsec protocols that are allowed to be used for this profile.</p> <p><b>Medium-Authentication Header (AH)</b> means data will be authenticated, but not be encrypted. By default, this option is invoked. You can uncheck it to disable it.</p> <p><b>High (ESP)</b> - High-Encapsulating Security Payload (ESP) means payload (data) will be encrypted and authenticated. You may select encryption algorithm from Data Encryption Standard (DES), Triple DES (3DES), and AES.</p> <p><b>Local ID (Optional)</b>- Specify a local ID to be used when establishing a LAN-to-LAN VPN connection using IKE aggressive mode.</p>
<p><b>Schedule Profile</b></p>	<p>Up to four schedule profiles can be set.</p>
<p><b>Notification</b></p>	<p><b>Send Email when VPN is up</b> - An e-mail will be sent to the user defined in Email Object when VPN is connected and up.</p> <ul style="list-style-type: none"> <li>● Mail to - Enter an email address.</li> </ul> <p><b>Send SMS when VPN is up</b> - An SMS will be sent to the user defined in SMS Object when VPN is connected and up.</p> <ul style="list-style-type: none"> <li>● SMS to - Enter a phone number.</li> </ul>

To save changes on the page, select OK; to discard changes, select Cancel; to clear settings on this page and revert to default settings, select Clear.

## V-1-11 LAN to LAN

This section allows you to configure up to 64 LAN-to-LAN VPN connections. LAN-to-LAN connections can be configured to allow dial-in only, dial-out only, or both dial-in and dial-out.

The following figure shows the summary table according to the item (All/Trunk) selected for View.

VPN and Remote Access >> LAN to LAN ?

---

LAN-to-LAN Profiles: | [Set to Factory Default](#) |

View:  All  Online  Offline  Trunk [ ] Search

Index	Enable	Always on	Name	Remote Network	Status	Index	Enable	Always on	Name	Remote Network	Status
<a href="#">1</a>	<input type="checkbox"/>	<input type="checkbox"/>	???		---	<a href="#">17</a>	<input type="checkbox"/>	<input type="checkbox"/>	???		---
<a href="#">2</a>	<input type="checkbox"/>	<input type="checkbox"/>	???		---	<a href="#">18</a>	<input type="checkbox"/>	<input type="checkbox"/>	???		---
<a href="#">3</a>	<input type="checkbox"/>	<input type="checkbox"/>	???		---	<a href="#">19</a>	<input type="checkbox"/>	<input type="checkbox"/>	???		---
<a href="#">4</a>	<input type="checkbox"/>	<input type="checkbox"/>	???		---	<a href="#">20</a>	<input type="checkbox"/>	<input type="checkbox"/>	???		---
<a href="#">5</a>	<input type="checkbox"/>	<input type="checkbox"/>	???		---	<a href="#">21</a>	<input type="checkbox"/>	<input type="checkbox"/>	???		---
<a href="#">6</a>	<input type="checkbox"/>	<input type="checkbox"/>	???		---	<a href="#">22</a>	<input type="checkbox"/>	<input type="checkbox"/>	???		---
<a href="#">7</a>	<input type="checkbox"/>	<input type="checkbox"/>	???		---	<a href="#">23</a>	<input type="checkbox"/>	<input type="checkbox"/>	???		---
<a href="#">8</a>	<input type="checkbox"/>	<input type="checkbox"/>	???		---	<a href="#">24</a>	<input type="checkbox"/>	<input type="checkbox"/>	???		---
<a href="#">9</a>	<input type="checkbox"/>	<input type="checkbox"/>	???		---	<a href="#">25</a>	<input type="checkbox"/>	<input type="checkbox"/>	???		---
<a href="#">10</a>	<input type="checkbox"/>	<input type="checkbox"/>	???		---	<a href="#">26</a>	<input type="checkbox"/>	<input type="checkbox"/>	???		---
<a href="#">11</a>	<input type="checkbox"/>	<input type="checkbox"/>	???		---	<a href="#">27</a>	<input type="checkbox"/>	<input type="checkbox"/>	???		---
<a href="#">12</a>	<input type="checkbox"/>	<input type="checkbox"/>	???		---	<a href="#">28</a>	<input type="checkbox"/>	<input type="checkbox"/>	???		---
<a href="#">13</a>	<input type="checkbox"/>	<input type="checkbox"/>	???		---	<a href="#">29</a>	<input type="checkbox"/>	<input type="checkbox"/>	???		---
<a href="#">14</a>	<input type="checkbox"/>	<input type="checkbox"/>	???		---	<a href="#">30</a>	<input type="checkbox"/>	<input type="checkbox"/>	???		---
<a href="#">15</a>	<input type="checkbox"/>	<input type="checkbox"/>	???		---	<a href="#">31</a>	<input type="checkbox"/>	<input type="checkbox"/>	???		---
<a href="#">16</a>	<input type="checkbox"/>	<input type="checkbox"/>	???		---	<a href="#">32</a>	<input type="checkbox"/>	<input type="checkbox"/>	???		---

<< [1-32](#) | [33-64](#) >> [Next](#) >>

Change default route to: None ▾

Pass packets from LAN in Routing mode to VPN

Pass Packets to WAN when VPN disconnects

OK Cancel

Backup setting to file:

Backup

Upload From File: 選擇檔案 未選擇任何檔案

Restore

Available settings are explained as follows:

Item	Description
Set to Factory Default	Click to clear all indexes.
View	All - Shows all LAN-to-LAN VPN profiles. Trunk - Shows all Trunk profiles (see VPN and Remote Access >> VPN TRUNK Management).
Index	Click the index number of the profile to view or edit its settings.
Enable	Check to enable the LAN-to-LAN VPN profile.
Always on	Check the box to enable the LAN-to-LAN VPN Dial-Out



	profile.
Name	Display the name of the LAN-to-LAN profile. The symbol ??? represents that the profile is empty.
Remote Network	Display the name of the remote network.
Status	Shows the status of the profile. Online - LAN-to-LAN VPN is connected. Offline - LAN-to-LAN VPN is disconnected. --- - Profile is disabled.
Change default route to	Change the default route to the selected VPN tunnel.
Pass packets from LAN in Routing mode to VPN	If enabled, the packets from routing LAN will pass through the VPN tunnel.
Pass Packets to WAN when VPN disconnects	If enabled, the packets can pass through via WAN when the VPN disconnects.
Backup	Click Backup to save the configuration.
Restore	Click Select to choose a configuration file. Then click Restore to apply the file.

The following figure shows profiles joined into VPN Load Balance and VPN Backup mechanism.

VPN and Remote Access >> LAN to LAN

LAN-to-LAN Profiles:

View:  All  Trunk

Name	Activate	Members	Status
<a href="#">Loadbalan1</a>	v	<a href="#">VPN-2</a>	Offline
		<a href="#">Connection</a>	Offline

[XXXXXX:This Dial-out profile has already joined for VPN Load Balance Mechanism]

[XXXXXX:This Dial-out profile has already joined for VPN Backup Mechanism]

If there is no profile joined yet, this page will be shown as follows:

VPN and Remote Access >> LAN to LAN

LAN-to-LAN Profiles:

View:  All  Trunk

Name	Activate	Members	Status

[XXXXXX:This Dial-out profile has already joined for VPN Load Balance Mechanism]

[XXXXXX:This Dial-out profile has already joined for VPN Backup Mechanism]

To edit each profile, click each index to edit each profile.

1. The setup screen is shown after a profile index has been clicked. There are 6 sections: Common Settings, Dial-Out Settings, Dial-In Settings, Tunnel Settings, 6in4 Settings and TCP/IP Network Settings.

VPN and Remote Access >> LAN to LAN

Profile Index : 1

Common Settings

<input type="checkbox"/> Enable this profile Profile Name <input type="text" value="???"/>	Always on <input type="checkbox"/> Enable Idle Timeout <input type="text" value="300"/> second(s) Quality Monitoring/Keep Alive <input type="checkbox"/> Enable
Call Direction <input checked="" type="radio"/> Both <input type="radio"/> Dial-Out <input type="radio"/> Dial-In <input type="radio"/> GRE Tunnel	Netbios Naming Packet <input checked="" type="radio"/> Pass <input type="radio"/> Block Multicast via VPN <input type="radio"/> Pass <input checked="" type="radio"/> Block (for some IGMP,IP-Camera,DHCP Relay .etc.)
Dial-Out Through <input type="text" value="WAN1 First"/>	

Dial-Out Settings

<b>VPN Server Type</b> <input checked="" type="radio"/> PPTP <input type="radio"/> IPsec Tunnel <input type="text" value="IKEv1"/> <input type="radio"/> L2TP with IPsec Policy <input type="text" value="Must"/> <input type="radio"/> SSL Tunnel <input type="radio"/> OpenVPN Tunnel <input type="text" value="TCP"/>	Username <input type="text" value="???"/> Password <input type="text" value="Max: 128 characters"/>
Server IP/Host Name <input type="text" value="Max: 128 characters"/>	<b>PPP Advanced Settings</b> +
Dial-Out <b>Schedule Profile</b> <input type="text" value="None"/> , <input type="text" value="None"/> , <input type="text" value="None"/> , <input type="text" value="None"/>	

Dial-In Settings

<b>Allowed VPN Type</b> <input type="checkbox"/> PPTP <input checked="" type="checkbox"/> IPsec Tunnel(IKEv1/IKEv2) <input checked="" type="checkbox"/> IPsec XAuth <input checked="" type="checkbox"/> L2TP with IPsec Policy <input type="text" value="Must"/> <input checked="" type="checkbox"/> SSL Tunnel <input checked="" type="checkbox"/> OpenVPN Tunnel <input type="text" value="UDP/TCP"/>	Username <input type="text" value="???"/> Password <input type="text" value="Max: 128 characters"/>
<input type="checkbox"/> Specify Remote VPN Gateway Remote IP <input type="text"/> Peer ID <input type="text" value="Max: 128 characters"/> Local ID <input type="text" value="Max: 47 characters"/>	<b>PPP Advanced Settings</b> + <b>OpenVPN Advanced Settings</b> + <b>Allowed IKE Authentication Method</b> <input checked="" type="checkbox"/> Pre-Shared Key <input type="text" value="Max: 128 characters"/> <input type="checkbox"/> X.509 Digital Signature <input type="text" value="None"/> Preferred Local ID <input type="text" value="Alternative Subject Name"/>
	<b>Allowed IPsec Security Method</b> <input checked="" type="checkbox"/> AH <input checked="" type="checkbox"/> ESP-DES <input checked="" type="checkbox"/> ESP-3DES <input checked="" type="checkbox"/> ESP-AES

Tunnel Settings

<input type="checkbox"/> Enable IPsec Dial-Out function GRE over IPsec Tunnel Local IP <input type="text"/>	<input type="checkbox"/> Logical Traffic Tunnel Remote IP <input type="text"/>
--	---

6in4 Settings

<input type="checkbox"/> Enable 6in4 over PPTP LAN Interface <input type="text" value="LAN1"/> Remote LAN IP <input type="text" value="0.0.0.0"/> LAN IPv6 Prefix <input type="text" value="::"/> / 64 Remote IPv6 Prefix <input type="text" value="::"/> / 64 Tunnel TTL <input type="text" value="255"/>
---

TCP/IP Network Settings

<b>Local Network</b> IP <input type="text" value="192.168.27.1"/> / Mask <input type="text" value="255.255.255.0 / 24"/> <b>Remote Network</b> IP <input type="text" value="0.0.0.0"/> / Mask <input type="text" value="255.255.255.0 / 24"/> More Remote Subnet +	Mode <input checked="" type="radio"/> Routing <input type="radio"/> NAT RIP via VPN <input type="text" value="Disable"/> Translate Local Network <input type="checkbox"/> Enable <input type="checkbox"/> Change Default Route to this VPN tunnel (This only works if there is only one WAN online)
--	---

Available settings are explained as follows:

Item	Description
<b>Common Settings</b>	
Enable this profile	Select to enable the profile.

	<p>Profile Name - Specify a name that allows you to identify this profile.</p> <p>Call Direction - Specify the allowed call direction of this LAN-to-LAN profile. Four choices are available for connection mode:</p> <ul style="list-style-type: none"> <li>● Both - Profile is to be used to initiate (dial out) or accept (dial in) connections.</li> <li>● Dial-Out - Profile is to be used to initiate outgoing connections.</li> <li>● Dial-In - Profile is to be used to accept incoming connections.</li> <li>● GRE Tunnel - Connection is by means of a GRE tunnel.</li> </ul> <p>Dial-Out Through - Select the WAN connection for connections made using this profile. This setting is useful for dial-out only.</p> <ul style="list-style-type: none"> <li>● WANx First - While connecting, the router will use WANx or LTE as the first channel for VPN connection. If WANx or LTE fails, the router will use another WAN interface instead.</li> <li>● WANx Only or LTE Only - While connecting, the router will use WANx or LTE as the only channel for VPN connection.</li> <li>● WAN1 Only: Only establish VPN if WAN2 down - If WAN2 failed, the router will use WAN1 for VPN connection.</li> <li>● WAN2 Only: Only establish VPN if WAN1 down - If WAN1 failed, the router will use WAN2 for VPN connection.</li> </ul> <p>Always On - Select this option to maintain an always on dial-out connection.</p> <p>Idle Timeout - The router will close connection if no activity is observed in the VPN connection for this many seconds. Default value is 300 seconds.</p> <p>Quality Monitoring/Keep Alive - Select this option to keep the VPN connection for the feature of SD-WAN quality monitoring.</p> <p>Netbios Naming Packet - Specifies whether to allow NetBIOS naming packets to traverse through the VPN tunnel.</p> <ul style="list-style-type: none"> <li>● Pass - click it to have an inquiry for data transmission between the hosts located on both sides of VPN Tunnel while connecting.</li> <li>● Block - When there is conflict occurred between the hosts on both sides of VPN Tunnel in connecting, such function can block data transmission of Netbios Naming Packet inside the tunnel.</li> </ul> <p>Multicast via VPN - Specifies whether to allow multicast packets to traverse through the VPN tunnel.</p> <ul style="list-style-type: none"> <li>● Pass - Click this button to let multicast packets pass through the router.</li> <li>● Block - This is default setting. Click this button to let multicast packets be blocked by the router.</li> </ul>
<b>Dial-Out Settings</b>	
VPN Server Type	Select the VPN protocol to be used.
Server IP/Host Name	IP address or DNS host name of remote VPN host.

Dial-Out Schedule Profile	Connect and disconnect according to schedule profiles. The default setting of this field is blank and the function will always work.
User Name	Enter a username for establishing VPN connection.
Password	Enter the password for establishing VPN connection.
If PPTP / L2TP with IPsec Policy / SSL Tunnel / is selected as VPN Server Type	<p>PPP Advanced Settings - Click it to expand the advanced settings for PPP.</p> <ul style="list-style-type: none"> <li>● PPP Authentication - <ul style="list-style-type: none"> <li>PAP Only - Authenticate dial-in users using the PAP protocol only. PAP/CHAP/MS-CHAP/MS-CHAPv2 - Attempt to authenticate dial-in users using various CHAP protocols, and if the remote VPN client fails to authenticate, fall back to PAP.</li> </ul> </li> <li>● VJ compression - Specifies whether to enable Van Jacobson (VJ) header compression, which improves throughput on slow connections.</li> <li>● Request IP Address - Enter the IP address.</li> </ul>
If IPsec/ L2TP with IPsec Policy is selected as VPN Server Type	<p>IKE Phase 1 Settings - Select from Main mode and Aggressive mode. The ultimate outcome is to exchange security proposals to create a protected secure channel. Main mode is more secure than Aggressive mode since more exchanges are done in a secure channel to set up the IPsec session. However, the Aggressive mode is faster. The default value in Vigor router is Main mode.</p> <ul style="list-style-type: none"> <li>● Authentication - Digital Signature(X.509) <ul style="list-style-type: none"> <li>- Peer ID - Select one of the predefined Profiles set in VPN and Remote Access &gt;&gt;IPsec Peer Identity.</li> <li>- Local ID - Use Alternative Subject Name or Subject Name of local certificate as local ID.</li> <li>- Local Certificate - Select one of the profiles set in Certificate Management&gt;&gt;Local Certificate.</li> </ul> </li> <li>● Authentication - Pre-Shared Key <ul style="list-style-type: none"> <li>- Pre-Shared Key - Input 1-128 characters as pre-shared key.</li> <li>- Local ID - Enter local IKE identity to send in the exchange to establish IPsec connection.</li> </ul> </li> <li>● proposal Encryption - Use Auto/AES/3DES/DES for packet encryption.</li> <li>● proposal ECDH Group - Specify a group if Auto is not selected as proposal Encryption.</li> <li>● proposal Authentication - Select SHA256 or SHA1 for packet authentication.</li> <li>● Force UDP Encapsulation - Select to make UDP encapsulation forcefully. All IPsec packets will be encapsulated with UDP header.</li> </ul> <p>IKE Phase 2 Settings - Specify the security protocol, proposal encryption and proposal authentication.</p> <ul style="list-style-type: none"> <li>● Security Protocol - AH (Medium) means data will be authenticated, but not be encrypted. By default, this option is active. ESP (High) means payload (data) will be encrypted and authenticated.</li> <li>● Proposal Encryption - Use AES/3DES encryption algorithm and apply MD5 or SHA-1 authentication</li> </ul>

	<p>algorithm.</p> <ul style="list-style-type: none"> <li>● Proposal Authentication - Select All, SHA or None.</li> </ul> <p>IKE Advanced Settings - Specify the key life of each IKE phase, network ID, etc.</p> <ul style="list-style-type: none"> <li>● IKE phase 1 key lifetime- For security reason, the lifetime of key should be defined. The default value is 28800 seconds. You may specify a value in between 900 and 86400 seconds.</li> <li>● IKE phase 2 key lifetime- For security reason, the lifetime of key should be defined. The default value is 3600 seconds. You may specify a value in between 600 and 86400 seconds.</li> <li>● Phase 2 Network ID - This is optional. Change the source IP address of VPN traffic to the specified IP address for NAT mode selected on TCP/IP Network Settings field.</li> <li>● Enable Perfect Forward Secret (PFS) - The IKE Phase 1 key will be reused to avoid the computation complexity in phase 2. The default value is inactive this function.</li> </ul> <p>Ping to Keep Alive - Select to enable the function of PING to keep alive.</p> <p>PING Target IP - Enter the IP address to keep alive.</p>
<p>If OpenVPN Tunnel with IPsec Policy is selected as VPN Server Type</p>	<p>OpenVPN Advanced Settings - Click to set the advanced settings for OpenVPN.</p> <ul style="list-style-type: none"> <li>● Cipher Algorithm - Select an algorithm for encrypting the packets via OpenVPN.</li> <li>● HMAC Algorithm - Select an algorithm for authenticating the packets via OpenVPN.</li> <li>● Client Certificate - Select a client certificate or self-signed a new certificate or DrayDDNS certificate.</li> <li>● Trust CA - Select a trust CA certificate.</li> <li>● Compress - Select a method to compress the packets to reduce the bandwidth usage while transferring the compressed packets.</li> <li>● TLS - auth - Select On to use the TLS authentication method. Related key information can be checked by clicking View.</li> </ul> <p>Import OpenVPN config file - An OpenVPN config file from other Vigor router can be imported and apply to this router.</p> <ul style="list-style-type: none"> <li>● Select File - Select a file from your hard disk.</li> <li>● Import - Click to upload the selected config file to this Vigor router.</li> </ul>
<p>Dial-In Settings</p>	
<p>Allowed VPN Type</p>	<p>Select permissible VPN protocols for dial-in connections.</p> <ul style="list-style-type: none"> <li>● PPTP - Allow the remote dial-in user to make a PPTP VPN connection through the Internet. You should set the User Name and Password of remote dial-in user below.</li> <li>● IPsec Tunnel(IKEv1/IKEv2)- Allow the remote dial-in user to trigger an IPsec VPN connection through Internet.</li> <li>● IPsec XAuth</li> <li>● L2TP with IPsec Policy - Allow the remote dial-in user to make a L2TP VPN connection through the Internet.</li> </ul>

	<p>You can select to use L2TP alone or with IPsec. Select from below:</p> <ul style="list-style-type: none"> <li>- None - Do not apply the IPsec policy. Accordingly, the VPN connection employed the L2TP without IPsec policy can be viewed as one pure L2TP connection.</li> <li>- Nice to Have - Apply the IPsec policy first, if it is applicable during negotiation. Otherwise, the dial-in VPN connection becomes one pure L2TP connection.</li> <li>- Must - Specify the IPsec policy to be definitely applied on the L2TP connection.</li> </ul> <ul style="list-style-type: none"> <li>● SSL Tunnel- Allow the remote dial-in user to trigger an SSL VPN connection through Internet.</li> <li>● OpenVPN Tunnel</li> </ul>
Specify Remote VPN Gateway	<p>You can specify the IP address of the remote dial-in user or peer ID (should be the same with the ID setting in dial-in type) by checking the box. Also, you should further specify the corresponding security methods on the right side.</p> <p>If you uncheck the checkbox, the connection type you select above will apply the authentication methods and security methods in the general settings.</p> <p>Username - This field is applicable when you select PPTP or L2TP with or without IPsec policy above. The length of the name is limited to 11 characters.</p> <p>Password - This field is applicable when you select PPTP or L2TP with or without IPsec policy above. The length of the password is limited to 11 characters.</p>
PPP Advanced Settings	<p>Click it to expand the advanced settings for PPP.</p> <p>VJ Compression - Specifies whether to enable Van Jacobson header compression, which improves throughput on slow connections.</p> <p>Assign Peer IP Address - Enter the IP address of the peer.</p>
OpenVPN Advanced Settings	<p>Cipher Algorithm - Select an algorithm for encrypting the packets via OpenVPN.</p> <p>HMAC Algorithm - Select an algorithm for authenticating the packets via OpenVPN.</p>
Allowed IKE Authentication Method	<p>This section is available when IPsec tunnel is selected as the dial-out protocol. Available options are IKE Pre-shared key and X.509 digital signature.</p> <p>Pre-Shared Key - To use a pre-shared key, select this radio-button and then click the IKE Pre-Shared Key button to enter the PSK.</p> <p>X.509 Digital Signature - To use an X.509 digital signature, select this radio button and then select an X.509 IPsec Peer Identity profile. To enable authentication using X.509 Peer IDs. X.509 profiles can be configured in VPN and Remote Access &gt;&gt; IPsec Peer Identity.</p> <ul style="list-style-type: none"> <li>● Local ID - Select whether to first match Subject Alternative Name or Subject Name during authentication.</li> </ul> <p>-Alternative Subject Name - The alternative subject name (configured in Certificate Management&gt;&gt;Local Certificate) will be inspected first.</p>

	-Subject Name - The subject name (configured in Certificate Management>>Local Certificate) will be inspected first.
Allowed IPsec Security Method	This setting is available when IPsec Tunnel is selected as the dial-out protocol. <ul style="list-style-type: none"> <li>● AH- Authentication Header (AH) means data will be authenticated, but not be encrypted. Select to use Authentication Header protocol. By default, this option is active.</li> <li>● ESP-DES/ESP-3DES/ESP-AES - Encapsulating Security Payload (ESP) means payload (data) will be encrypted and authenticated. You may select encryption algorithm from Data Encryption Standard (DES), Triple DES (3DES), and AES.</li> </ul>
<b>Tunnel Settings</b>	
Enable IPsec Dial-Out function GRE over IPsec	Check this box to verify data and transmit data in encryption with GRE over IPsec packet after configuring IPsec Dial-Out setting. Both ends must match for each other by setting same virtual IP address for communication.
Logical Traffic	Such technique comes from RFC2890. Define logical traffic for data transmission between both sides of VPN tunnel by using the characteristic of GRE. Even hacker can decipher IPsec encryption, he/she still cannot ask LAN site to do data transmission with any information. Such function can ensure the data transmitted on VPN tunnel is really sent out from both sides. This is an optional function. However, if one side wants to use it, the peer must enable it, too.
Tunnel Local IP	Enter the virtual IP for router itself for verified by peer.
Tunnel Remote IP	Enter the virtual IP of peer host for verified by router.
<b>6in4 Settings</b>	
Enable 6in4 over PPTP	Transmit the IPv6 packets from the local site to the remote site via IPv4 VPN tunnel with the encapsulation technology, 6in4.  Check to enable the function. The IPv6 packets can pass through WAN PPTP VPN tunnel to the remote site.
LAN Interface	Specify a LAN interface for transmitting the packets.
Remote LAN IP	Specify the IP address of the remote site.
LAN IPv6 Prefix	Specify the prefix (with length) of the local site.
Remote IPv6 Prefix	Specify the prefix (with length) of the remote site.
Tunnel TTL	Enter a value.
<b>TCP/IP Network Settings</b>	
Local Network	The default value is 0.0.0.0, which means the Vigor router will get a PPP IP address from the remote router during the IPCP negotiation phase. If the PPP IP address is fixed by remote side, specify the fixed IP address here. Do not change

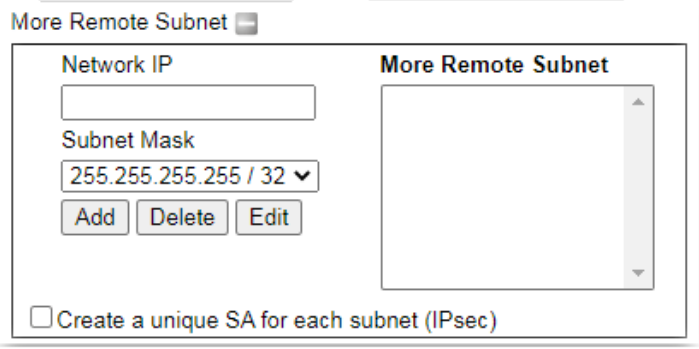
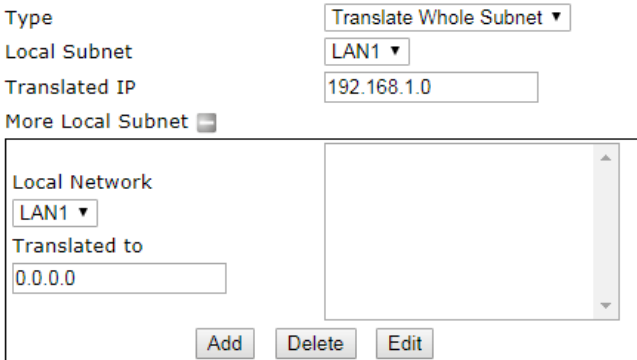
	<p>the default value if you do not select PPTP or L2TP.</p> <p>IP / Mask - Display the local network IP and mask for TCP / IP configuration. You can modify the settings if required.</p>
<p>Remote Network</p>	<p>The default value is 0.0.0.0, which means the Vigor router will get a remote Gateway PPP IP address from the remote router during the IPCP negotiation phase. If the PPP IP address is fixed by remote side, specify the fixed IP address here. Do not change the default value if you do not select PPTP or L2TP.</p> <p>IP/ Mask - Add a static route to direct all traffic destined to this Remote Network IP Address/Remote Network Mask through the VPN connection. For IPsec, this is the destination clients IDs of phase 2 quick mode.</p>
<p>More Remote Subnet</p>	<p>Click to bring up a dialog box to enter additional static routes for subnets destined for the remote network.</p> 
<p>Mode</p>	<p>If the remote network only allows one IP address for the local network, select NAT; otherwise, select Route.</p>
<p>When the Mode is set to Routing</p>	<p>When Routing is selected, the available fields in the TCP/IP Network Settings section will be shown as:</p> <p>Translate Local Network - Check the box to enable the function. Add a static route to direct all traffic destined to more Remote Network IP Addresses/ Remote Network Mask through the VPN connection. This is usually used when you find there are several subnets behind the remote VPN router.</p> <ul style="list-style-type: none"> <li>● Type - There are two types (Translate Whole Subnet, Translate Specific IP) for you to choose.</li> </ul> <p>When Translate Whole Subnet is selected as Type, available settings are listed as below:</p>  <ul style="list-style-type: none"> <li>- Local Subnet - Select the LAN whose IP addresses are to be translated.</li> <li>- Translated IP - Specify an IP address.</li> <li>- More Local Subnet - Click it to add more subnets.</li> </ul>



	<p>When Translate Specific IP is selected as Type, available settings are listed as below:</p> <p>Type <span style="float: right;">Translate Specific IP ▼</span></p> <div style="border: 1px solid black; padding: 5px; width: fit-content;"> <p><b>Virtual IP Mapping</b></p> <div style="border: 1px solid gray; height: 60px; margin-bottom: 5px;"></div> <p>Local IP <span style="margin-left: 150px;">Virtual IP</span></p> <div style="display: flex; justify-content: space-between; width: 100%;"> <input style="width: 100px;" type="text"/> <input style="width: 100px;" type="text"/> </div> <div style="display: flex; justify-content: center; gap: 10px; margin-top: 5px;"> <input type="button" value="Add"/> <input type="button" value="Delete"/> <input type="button" value="Edit"/> </div> </div> <p>- Virtual IP Mapping - A pop up dialog will appear for you to specify the local IP address and the mapping virtual IP address.</p>
<p>When the Mode is set to NAT</p>	<p>When NAT is selected, the available fields in the TCP/IP Network Settings section will be shown as:</p> <p>RIP via VPN - Specifies the direction of Routing Information Protocol (RIP) packets. Available options are:</p> <ul style="list-style-type: none"> <li>● TX/RX Both - can transmit or receive RIP packets</li> <li>● TX Only - can only transmit but not receive RIP packets</li> <li>● RX Only - can only receive but not transmit RIP packets</li> <li>● Disable - RIP is disabled.</li> </ul> <p>Change Default Route to this VPN tunnel - Select this option to direct all traffic that is not LAN-bound to this VPN tunnel. This option is functional when there is only one active WAN.</p>

2. To save changes on the LAN to LAN profile page, select OK; to reset the entire page to blank, select Clear; to discard changes, select Cancel.

---

## V-1-12 VPN Trunk Management

A VPN Trunk combines TWO LAN-to-LAN VPN tunnels to provide VPN Backup or VPN Load Balance functionalities.

### VPN Backup

VPN Backup provides redundant, uninterrupted VPN connectivity by constantly monitoring the health of a VPN tunnel, and fails over to the secondary VPN tunnel when the primary tunnel fails.

In a Backup VPN Trunk, only one of the two LAN-to-LAN VPN tunnels is connected at any given time. When one tunnel fails, the router will automatically start up and direct all VPN traffic destined for the trunk to the other tunnel.

### VPN Load Balance

VPN Load Balance increases the bandwidth of a LAN-to-LAN connection by combining and load balancing two tunnels, with the option to direct traffic to specific tunnels by originating address, destination address or port.

In a Load Balance VPN Trunk, both LAN-to-LAN VPN tunnels are simultaneously connected. The router first attempts to match the traffic to a load balance policy rule and send it down the tunnel specified in the matching rule. Traffic not matched to any policy will be load balanced in a round-robin fashion, and the traffic ratio between the two tunnels is either determined automatically by the router or specified by the user.

In order to set up a VPN Trunk, 2 LAN-to-LAN VPN profiles must have been configured first. For details on the configuration of LAN-to-LAN VPN tunnels, see section V-1-10 LAN to LAN. When the 2 LAN-to-LAN VPN profiles are ready, follow the steps below to set up a VPN Trunk.

## Creating a VPN Trunk

To create a new VPN Trunk, configure the General Setup section first.

VPN and Remote Access >> VPN TRUNK Management



Backup Profile List | [Set to Factory Default](#)

**Note:**  
[Active:NO] The LAN-to-LAN Profile is disabled or under Dial-In(Call Direction) at present.

No.	Status	Name	Member1 (Active) Type	Member2 (Active) Type

Advanced

Load Balance Profile List | [Set to Factory Default](#)

**Note:**  
[Active:NO] The LAN-to-LAN Profile is disabled or under Dial-In(Call Direction) at present.

No.	Status	Name	Member1 (Active) Type	Member2 (Active) Type

Advanced

General Setup

Status  Enable  Disable

Profile Name

Member1

Member2

Active Mode  Backup  Load Balance

Available settings are explained as follows:

Item	Description
General Setup	<p>Status - Enable or disable the VPN Trunk.</p> <ul style="list-style-type: none"> <li>● Enable - Select this to enable this VPN trunk.</li> <li>● Disable - Select this to disable this VPN trunk.</li> </ul> <p>Profile Name - Enter a name to identify this VPN Trunk profile.</p> <p>Member 1/Member2 - Select LAN-to-LAN VPN profiles to be the first and second members of this VPN Trunk.</p> <p>Active Mode - Select the operation mode of the VPN Trunk.</p> <p>Backup / Load Balance - Select this to set up a Backup / Load Balance VPN Trunk.</p> <p>Add - Select it to add a VPN Trunk Profile using the entered information.</p> <p>Update - Select it to save the changes to the Status (Enable or Disable), profile name, member1 or member2.</p> <p>Delete - Select it to delete the selected VPN TRUNK profile. The corresponding members (LAN-to-LAN profiles) grouped</p>

in the deleted VPN TRUNK profile will be released and that profiles in LAN-to-LAN will be displayed in black.

## Configuring, Modifying or Deleting a VPN Trunk

To configure or modify a VPN Trunk, go to the Profile List section that corresponds to the type of the VPN trunk (Backup or Load Balance).

VPN and Remote Access >> VPN TRUNK Management



### Backup Profile List [Set to Factory Default](#)

**Note:**  
[Active:NO] The LAN-to-LAN Profile is disabled or under Dial-In(Call Direction) at present.

No.	Status	Name	Member1 (Active) Type	Member2 (Active) Type

Advanced

### Load Balance Profile List [Set to Factory Default](#)

**Note:**  
[Active:NO] The LAN-to-LAN Profile is disabled or under Dial-In(Call Direction) at present.

No.	Status	Name	Member1 (Active) Type	Member2 (Active) Type

Advanced

### General Setup

Status  Enable  Disable

Profile Name

Member1

Member2

Active Mode  Backup  Load Balance

Available settings are explained as follows:

Item	Description
Backup Profile List and Load Balance Profile List	<p><b>Set to Factory Default</b> - Removes all VPN Trunk profiles in the Profile List.</p> <p><b>No.</b> - The index number of VPN profile.</p> <p><b>Status</b> - Shows whether the VPN Trunk is enabled or disabled.</p> <ul style="list-style-type: none"> <li>● v - VPN Trunk is enabled.</li> <li>● x - VPN Trunk is disabled.</li> </ul> <p><b>Name</b> - The user-entered name that identifies the trunk profile.</p> <p><b>Member1 (Active) Type / Member2 (Active) Type</b> - Shows the profile index, whether it is enabled or disabled, and the VPN protocol of the 2 LAN-to-LAN VPN profiles.</p> <p>Example: 1(YES)PPTP - the trunk member is set to use the</p>

	<p>first profile which is currently enabled and uses the PPTP protocol.</p> <p>Advanced - To configure advanced settings of a VPN Trunk profile, select its name from the dropdown list and click Advanced.</p>
<p>Advanced for Backup Profile List</p>	<p>If a Backup Profile was selected, the following Advanced Settings screen appears:</p> <div data-bbox="703 450 1422 651" style="border: 1px solid black; padding: 5px;"> <p><b>VPN Backup Advance Settings</b></p> <p>Profile Name: Trunk1</p> <p>ERD Mode: <input checked="" type="radio"/> Normal <input type="radio"/> Resume (Member 1 first)</p> <p>Detail Information: Environment Recovers Detection(ERD) Status: Normal Mode</p> <p style="text-align: right;"><input type="button" value="OK"/> <input type="button" value="Close"/></p> </div> <p>Profile Name - User-defined name that identifies this profile.</p> <p>ERD Mode - Sets the Environment Recovery Detection (ERD) mode.</p> <ul style="list-style-type: none"> <li>● Normal - Both VPN tunnels have equivalent priority.</li> <li>● Resume - Member 1 and Member 2 VPN tunnels are primary and secondary connections, respectively. The router will always attempt to use Member 1 first, and only fail over to Member 2 if Member 1 is down.</li> </ul> <p>Detail Information - Provides a detailed explanation of the ERD mode.</p> <p>To save Advanced Settings for the profile, select OK; to close without saving changes, select Close.</p>
<p>Advanced for Load Balance Profile List</p>	<p>If a Load Balance Profile was selected, the following Advanced Settings screen appears:</p> <div data-bbox="703 1200 1422 1917" style="border: 1px solid black; padding: 5px;"> <p><b>VPN Load Balance Advance Settings</b></p> <p>Profile Name: Trunk2</p> <p>Load Balance Algorithm: <input checked="" type="radio"/> Round Robin <input type="radio"/> Weighted Round Robin <input checked="" type="radio"/> Auto Weighted <input type="radio"/> According to Speed Ratio (Member1:Member2): 50:50</p> <p>VPN Load Balance Policy</p> <p><input checked="" type="radio"/> Edit <input type="radio"/> Insert after</p> <p>Tunnel Bind Table Index: <input type="text" value="1"/> (1~64)</p> <p>Active: <input type="text" value="Active"/></p> <p>Binding Dial Out Profile: <input type="text" value="1"/></p> <p>Src IP Start: <input type="text" value="0.0.0.0"/> End: <input type="text" value="255.255.255.255"/></p> <p>Dest IP Start: <input type="text" value="0.0.0.0"/> End: <input type="text" value="255.255.255.255"/></p> <p>Dest Port Start: <input type="text" value="1"/> End: <input type="text" value="65535"/></p> <p>Protocol: <input type="text" value="ANY"/> <input type="text" value="0"/></p> <p style="text-align: right;"><input type="button" value="OK"/> <input type="button" value="Close"/></p> <p>Detail Information</p> <p>[VPN Load Balance Profile name: Trunk2 ] [Algorithm: Round Robin ]</p> </div> <p>Profile Name - User-defined name that identifies this profile.</p> <p>Load Balance Algorithm - Configures how load balancing is performed.</p>

	<ul style="list-style-type: none"> <li>● Round Robin - All outgoing connections that do not match to any load balance policy are evenly distributed between the tunnels.</li> <li>● Weighted Round Robin -- All outgoing connections that do not match to any load balance policy are distributed between the tunnels based on a ratio that is either automatically determined by the router (Auto Weighted), or specified by the user (According to Speed Ratio).</li> </ul> <p>VPN Load Balance Policy - This section allows the modification or addition of load balance policy profiles.</p> <p>Edit / Insert After - Select Edit to modify the existing load balance profile with index specified in Tunnel Bind Table Index, or Insert After to insert a new load balance profile immediately after the index position specified in Tunnel Bind Table Index.</p> <p>Tunnel Bind Table Index- 64 Binding tunnel tables are provided by this device. In Edit mode, the profile that matches this index will be updated.</p> <p>In Insert After mode, a new profile will be inserted immediately after the policy having this index.</p> <p>Active - Includes Active and Clear. In which,</p> <ul style="list-style-type: none"> <li>● Active - All information will be saved into a load balance profile.</li> <li>● Clear - The profile with index matching Tunnel Bind Table Index will be deleted.</li> </ul> <p>Binding Dial Out Profile - The LAN-to-LAN VPN tunnel to which traffic matching this policy will be sent.</p> <p>Scr IP Start /End- Specify source IP addresses as starting point and ending point.</p> <p>Dest IP Start/End - Specify the target IP addresses as starting point and ending point.</p> <p>Dest Port Start /End- Specify the target port range if the protocol is TCP or UDP.</p> <p>Protocol - Specify the protocol of the traffic.</p> <p>Detail Information - Shows all the information about the Load Balance profile.</p> <p>To save Advanced Settings for the profile, select OK; to close without saving changes, select Close.</p>
Add	Select it to add a VPN Trunk Profile using the entered information.
Update	<p>Make modifications as necessary in the General Setup section.</p> <p>Select it to save the changes to the Status (Enable or Disable), profile name, member1 or member2.</p>
Delete	<p>Select it to remove the VPN TRUNK profile.</p> <p>The corresponding members (LAN-to-LAN profiles) grouped in the deleted VPN TRUNK profile will be released and that profiles in LAN-to-LAN will be displayed in black.</p>

## V-1-13 Connection Management

You can initiate outbound LAN-to-LAN VPN sessions, and view and disconnect all current LAN-to-LAN and dial-up VPN sessions.

VPN and Remote Access >> Connection Management

Dial-out Tool | Refresh |

General Mode:	( toEdge_VN ) 27.71.238.25	Dial
Backup Mode:		Dial
Load Balance Mode:		Dial

### VPN Connection Status

All VPN Status		LAN-to-LAN VPN Status		Remote Dial-in User Status				
VPN	Type	Remote IP	Virtual Network	Tx Pkts	Tx Rate(bps)	Rx Pkts	Rx Rate(bps)	UpTime
1	IKEV2 IPsec Tunnel PSK ( toEdge_VN ) AES128-CBC-SHA1 Auth	via WAN3	192.168.100.0/24	0	0	0	0	1 day 17:49:00
2	IKEV2 IPsec Tunnel PSK ( KD5 ) AES256-CBC-SHA256 Auth	via WAN3	172.17.5.0/24	173	0	496	72	00:31:21

No subpagging  No auto refreshing

~~~~~ : Data is encrypted.  
 ~~~~~ : Data isn't encrypted.  
 ~~~~~ : Waiting Client 2FA.

Available settings are explained as follows:

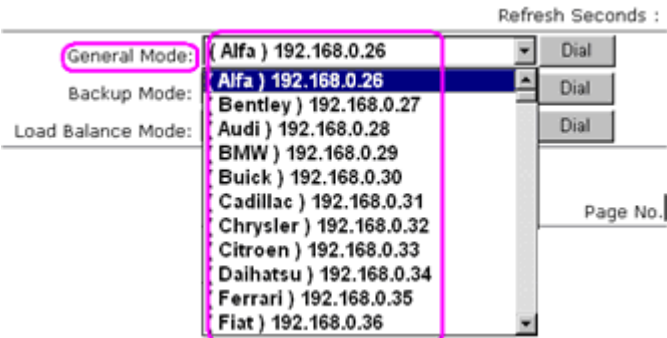
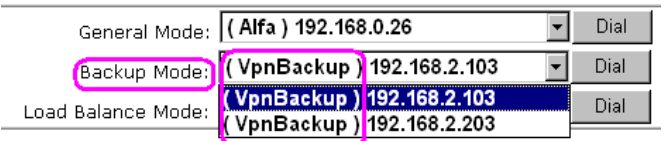
| Item          | Description                                                                                                                                                                                                                                                                                                                                                                                                                                                                                                                                                                                                                                                                                                                                                                                                                                                                                                                        |
|---------------|------------------------------------------------------------------------------------------------------------------------------------------------------------------------------------------------------------------------------------------------------------------------------------------------------------------------------------------------------------------------------------------------------------------------------------------------------------------------------------------------------------------------------------------------------------------------------------------------------------------------------------------------------------------------------------------------------------------------------------------------------------------------------------------------------------------------------------------------------------------------------------------------------------------------------------|
| Refresh       | Click to manually reload the page to refresh VPN connection information.                                                                                                                                                                                                                                                                                                                                                                                                                                                                                                                                                                                                                                                                                                                                                                                                                                                           |
| Dial-out Tool | <p>The Dial-out Tool section can be used to initiate outgoing LAN-to-LAN VPN sessions.</p> <p><b>General Mode</b> - It lists all LAN-to-LAN VPN profiles that do not belong to enabled VPN Trunk profiles.</p> <p>To manually dial a LAN-to-LAN VPN profile, select it from the combo box, and click the Dial button to the right. The VPN connection built by General Mode does not support VPN backup function.</p>  <p><b>Backup Mode</b> - It lists all Backup VPN Trunk profiles. To manually dial a Backup VPN Trunk profile, select it from the combo box, and click the Dial button to the right. The VPN connection built by Backup Mode supports VPN backup function.</p>  <p><b>Load Balance Mode</b> - It lists all Load Balance VPN Trunk</p> |

|                       |                                                                                                                                                                                                                                                                                                                                                                                                                                                                                                                                                                                                                                                                                                                                                                                                            |
|-----------------------|------------------------------------------------------------------------------------------------------------------------------------------------------------------------------------------------------------------------------------------------------------------------------------------------------------------------------------------------------------------------------------------------------------------------------------------------------------------------------------------------------------------------------------------------------------------------------------------------------------------------------------------------------------------------------------------------------------------------------------------------------------------------------------------------------------|
|                       | <p>profiles. To manually dial a Load Balance VPN Trunk profile, select it from the combo box, and click the Dial button to the right.</p> <p>Dial - Click this button to execute dial out function. If the connect is successfully made, it will show up in the VPN Connection Status section below.</p>                                                                                                                                                                                                                                                                                                                                                                                                                                                                                                   |
| VPN Connection Status | <p>VPN - Displays the VPN profile number and the profile name.</p> <p>Type - Displays the VPN protocol used for the connection</p> <p>Remote IP - Displays the remote IP address of the VPN connection.</p> <p>Virtual Network - Displays the IP subnet used by the VPN connection.</p> <p>Tx Pkts - Displays the number of packets that have been transmitted through the VPN connection.</p> <p>Tx Rate(Bps) - Displays the current upstream speed of the VPN connection.</p> <p>Rx Pkts - Displays the number of packets that have been received through the VPN connection.</p> <p>Rx Rate(Bps) - Displays the current downstream speed of the VPN connection.</p> <p>UpTime - Displays the elapsed time of the VPN connection.</p> <p>Drop - Click this button to disconnect this VPN connection.</p> |



---

## V-2 Certificate Management

A digital certificate is an electronic document issued by a certification authority (CA) to an entity to prove ownership of a public key. It contains identifying information including the issued-to party's name, a serial number, expiration dates etc., and the digital signature of the certificate-issuing authority so that a recipient can verify that the certificate is real. Vigor router supports digital certificates that conform to the X.509 standard.

In this section, you can generate and manage local digital certificates, and import trusted CA certificates. Be sure that the system time is correct on the router so that certificates will not be erroneously considered to be invalid because of an incorrect system time falling outside of the certificate's valid time period. The easiest way to accomplish this is by periodically synchronizing the system time to a Network Time Protocol (NTP) server.

The image below shows the menu items for Certificate Management.

# Web User Interface

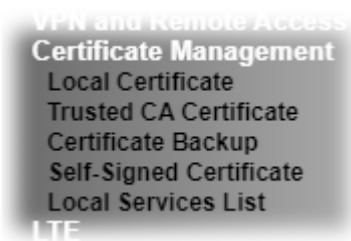

## V-2-1 Local Certificate

You can generate, import or view local certificates on this page.

Certificate Management >> Local Certificate

### X509 Local Certificate Configuration

| Name | Subject | Status                                                                        | CA | Modify |
|------|---------|-------------------------------------------------------------------------------|----|--------|
|      |         | <input type="button" value="GENERATE"/> <input type="button" value="IMPORT"/> |    |        |

### Storage for Certificate



**Note:**

1. Please setup the "System Maintenance >> **Time and Date**" correctly before signing the local certificate.
2. The Time Zone **MUST** be setup correctly!!
3. Local Certificate and Trusted CA Certificate share a storage space.
4. CA field means the certificate issuer has been imported to router.

Certificate Management >> Local Certificate

### X509 Local Certificate Configuration

| Name   | Subject                         | Status                                                                        | CA | Modify                                                                    |
|--------|---------------------------------|-------------------------------------------------------------------------------|----|---------------------------------------------------------------------------|
| server | C = TW, ST = HS, L = SF, O =... | Requesting                                                                    |    | <input type="button" value="View"/> <input type="button" value="Delete"/> |
|        |                                 | <input type="button" value="GENERATE"/> <input type="button" value="IMPORT"/> |    |                                                                           |

### Storage for Certificate



**Note:**

1. Ensure Time Zone is correctly set up in "System Maintenance >> **Time and Date**" before signing the local certificate.
2. Certificate files will be deleted when downgrading router firmware from version 4.4.0 to an older version.
3. Local Certificate and Trusted CA Certificate share a storage space.
4. CA field means the certificate issuer has been imported to router.

Available settings are explained as follows:

| Item    | Description                                           |
|---------|-------------------------------------------------------|
| Name    | Displays the Name that identifies the certificate.    |
| Subject | Displays the Subject Name entries of the certificate. |

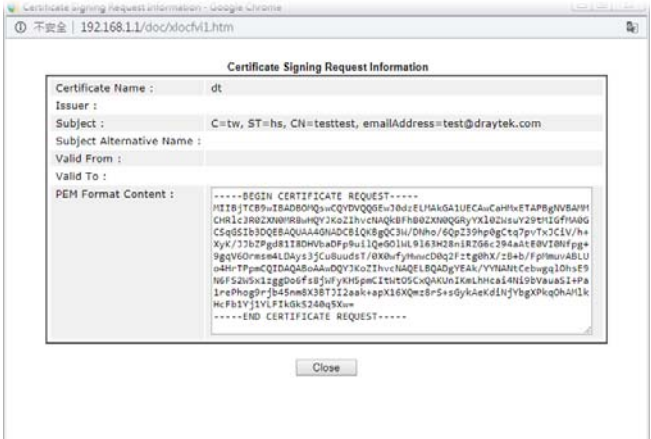
|                         |                                                                                                                                                                                                                                                                                                                                                                                                                   |
|-------------------------|-------------------------------------------------------------------------------------------------------------------------------------------------------------------------------------------------------------------------------------------------------------------------------------------------------------------------------------------------------------------------------------------------------------------|
| Status                  | Displays the status of the certificate.                                                                                                                                                                                                                                                                                                                                                                           |
| Modify                  | <p><b>View</b> - Click to view details about the certificate. A screen that looks like the following will be displayed, showing the Subject Name, Subject Alternative Name, and the certificate content.</p> <p><b>Delete</b> - Click to remove the selected name.</p>  <p><b>Delete</b> - Click to remove the certificate.</p> |
| Generate                | Click to fill out details about a certificate, and start the generation process.                                                                                                                                                                                                                                                                                                                                  |
| Storage for Certificate | Display the percentage of the storage usage.                                                                                                                                                                                                                                                                                                                                                                      |
| Refresh                 | Click this button to refresh the information on this page.                                                                                                                                                                                                                                                                                                                                                        |

## GENERATE

Use this screen to submit a request to your root CA to generate a certificate.

Certificate Management >> Local Certificate

### Generate Certificate Signing Request

|                                 |                                 |
|---------------------------------|---------------------------------|
| Certificate Name                | <input type="text"/>            |
| <b>Subject Alternative Name</b> |                                 |
| Type                            | IP Address <input type="text"/> |
| IP                              | <input type="text"/>            |
| <b>Subject Name</b>             |                                 |
| Country (C)                     | <input type="text"/>            |
| State (ST)                      | <input type="text"/>            |
| Location (L)                    | <input type="text"/>            |
| Organization (O)                | <input type="text"/>            |
| Organization Unit (OU)          | <input type="text"/>            |
| Common Name (CN)                | <input type="text"/>            |
| Email (E)                       | <input type="text"/>            |
| Key Type                        | RSA <input type="text"/>        |
| Key Size                        | 2048 Bit <input type="text"/>   |
| Algorithm                       | SHA-256 <input type="text"/>    |

Generate

Available settings are explained as follows:

| Item                   | Description                                                                                                |
|------------------------|------------------------------------------------------------------------------------------------------------|
| Certificate Name       | Name that identifies the certificate.                                                                      |
| Type                   | Select the type (IP address, Domain name, E-mail or None) of Subject Alternative Name and enter its value. |
| Country (C)            | Country in which your organization is located.                                                             |
| State (ST)             | State or province where your organization is located.                                                      |
| Location (L)           | City where your organization is located.                                                                   |
| Organization (O)       | Legal name of your organization.                                                                           |
| Organization Unit (OU) | Department within your organization that you wish to be associated with this certificate.                  |
| Common Name (CN)       | Fully-qualified domain name / WAN IP that will be used to reach your server.                               |
| Email (E)              | Email address of the entry.                                                                                |
| Key Type               | Key type is hard set to RSA.                                                                               |
| Key Size               | Choose between 1024 and 2048 bit.                                                                          |
| Algorithm              | Choose between SHA-1 and SHA-256.                                                                          |
| Generate               | Click to submit generate request to the CA server.                                                         |

After clicking the Generate button, you will be taken back to the main Local Certificate screen, showing the certificate request in progress:

Certificate Management >> Local Certificate

#### X509 Local Certificate Configuration

| Name   | Subject                         | Status                                  | CA                                                                                    | Modify                                                                    |
|--------|---------------------------------|-----------------------------------------|---------------------------------------------------------------------------------------|---------------------------------------------------------------------------|
| server | C = TW, ST = HS, L = SF, O =... | Requesting                              |  | <input type="button" value="View"/> <input type="button" value="Delete"/> |
|        |                                 | <input type="button" value="GENERATE"/> | <input type="button" value="IMPORT"/>                                                 |                                                                           |

#### Storage for Certificate



#### Note:

1. Please setup the "System Maintenance >> **Time and Date**" correctly before signing the local certificate.
2. The Time Zone **MUST** be setup correctly!!
3. Local Certificate and Trusted CA Certificate share a storage space.
4. CA field means the certificate issuer has been imported to router.

## IMPORT

Vigor router allows you to generate a certificate request and submit it the CA server, then import it as "Local Certificate". If you have already gotten a certificate from a third party, you may import it directly. The supported types are PKCS12 Certificate and Certificate with a private key.

Click this button to import a saved file as the certification information. There are three types of local certificate supported by Vigor router.

**Import X509 Local Certificate**

**Upload Local Certificate**  
 Select a local certificate file.  
 Certificate file:    
 Click **Import** to upload the local certificate.

---

**Upload PKCS12 Certificate**  
 Select a PKCS12 file.  
 PKCS12 file:    
 Password:   
 Click **Import** to upload the PKCS12 file.

---

**Upload Certificate and Private Key**  
 Select a certificate file and a matchable Private Key.  
 Certificate file:    
 Key file:    
 Password:   
 Click **Import** to upload the local certificate and private key.

Available settings are explained as follows:

| Item                      | Description                                                                                                                                                                                                                                                                                                                                                                                                                                                                                                                                                                                                                                                                                                                                                                                                                                                                                                                                                                                                                                                                                                                                                                                                                                                                                                                                                                                                                                                                                                                                                                                                                                                                                                                                                                                                                                                   |        |                                                                           |        |        |             |                                 |    |                                                                           |     |     |     |                                                                           |     |     |     |                                                                           |
|---------------------------|---------------------------------------------------------------------------------------------------------------------------------------------------------------------------------------------------------------------------------------------------------------------------------------------------------------------------------------------------------------------------------------------------------------------------------------------------------------------------------------------------------------------------------------------------------------------------------------------------------------------------------------------------------------------------------------------------------------------------------------------------------------------------------------------------------------------------------------------------------------------------------------------------------------------------------------------------------------------------------------------------------------------------------------------------------------------------------------------------------------------------------------------------------------------------------------------------------------------------------------------------------------------------------------------------------------------------------------------------------------------------------------------------------------------------------------------------------------------------------------------------------------------------------------------------------------------------------------------------------------------------------------------------------------------------------------------------------------------------------------------------------------------------------------------------------------------------------------------------------------|--------|---------------------------------------------------------------------------|--------|--------|-------------|---------------------------------|----|---------------------------------------------------------------------------|-----|-----|-----|---------------------------------------------------------------------------|-----|-----|-----|---------------------------------------------------------------------------|
| Upload Local Certificate  | <p>Certificate file - Click Browse to select a local certificate file.<br/>                     Import - Click to import selected certificate file to router.<br/>                     Cancel - Click to return to the main Local Certificate screen.<br/>                     If you have done well in certificate generation, the Status of the certificate will be shown as "OK".</p> <div style="border: 1px solid gray; padding: 5px; margin: 5px 0;"> <p style="text-align: center;"><b>Import X509 Local Certificate</b></p> <p style="text-align: center;"><b>Congratulation!</b><br/>                         Local Certificate has been imported successfully.<br/>                         Please click <input type="button" value="Back"/> to view the certificate.</p> </div> <div style="border: 1px solid gray; padding: 5px; margin: 5px 0;"> <p style="text-align: center;"><b>X509 Local Certificate Configuration</b></p> <table border="1" style="width: 100%; border-collapse: collapse;"> <thead> <tr> <th style="text-align: left;">Name</th> <th style="text-align: left;">Subject</th> <th style="text-align: left;">Status</th> <th style="text-align: left;">Modify</th> </tr> </thead> <tbody> <tr> <td>draytekdemo</td> <td>/O=Draytek/OU=Draytek Sales/...</td> <td>OK</td> <td><input type="button" value="View"/> <input type="button" value="Delete"/></td> </tr> <tr> <td>---</td> <td>---</td> <td>---</td> <td><input type="button" value="View"/> <input type="button" value="Delete"/></td> </tr> <tr> <td>---</td> <td>---</td> <td>---</td> <td><input type="button" value="View"/> <input type="button" value="Delete"/></td> </tr> </tbody> </table> <p style="text-align: center;"><input type="button" value="GENERATE"/> <input type="button" value="IMPORT"/> <input type="button" value="REFRESH"/></p> </div> | Name   | Subject                                                                   | Status | Modify | draytekdemo | /O=Draytek/OU=Draytek Sales/... | OK | <input type="button" value="View"/> <input type="button" value="Delete"/> | --- | --- | --- | <input type="button" value="View"/> <input type="button" value="Delete"/> | --- | --- | --- | <input type="button" value="View"/> <input type="button" value="Delete"/> |
| Name                      | Subject                                                                                                                                                                                                                                                                                                                                                                                                                                                                                                                                                                                                                                                                                                                                                                                                                                                                                                                                                                                                                                                                                                                                                                                                                                                                                                                                                                                                                                                                                                                                                                                                                                                                                                                                                                                                                                                       | Status | Modify                                                                    |        |        |             |                                 |    |                                                                           |     |     |     |                                                                           |     |     |     |                                                                           |
| draytekdemo               | /O=Draytek/OU=Draytek Sales/...                                                                                                                                                                                                                                                                                                                                                                                                                                                                                                                                                                                                                                                                                                                                                                                                                                                                                                                                                                                                                                                                                                                                                                                                                                                                                                                                                                                                                                                                                                                                                                                                                                                                                                                                                                                                                               | OK     | <input type="button" value="View"/> <input type="button" value="Delete"/> |        |        |             |                                 |    |                                                                           |     |     |     |                                                                           |     |     |     |                                                                           |
| ---                       | ---                                                                                                                                                                                                                                                                                                                                                                                                                                                                                                                                                                                                                                                                                                                                                                                                                                                                                                                                                                                                                                                                                                                                                                                                                                                                                                                                                                                                                                                                                                                                                                                                                                                                                                                                                                                                                                                           | ---    | <input type="button" value="View"/> <input type="button" value="Delete"/> |        |        |             |                                 |    |                                                                           |     |     |     |                                                                           |     |     |     |                                                                           |
| ---                       | ---                                                                                                                                                                                                                                                                                                                                                                                                                                                                                                                                                                                                                                                                                                                                                                                                                                                                                                                                                                                                                                                                                                                                                                                                                                                                                                                                                                                                                                                                                                                                                                                                                                                                                                                                                                                                                                                           | ---    | <input type="button" value="View"/> <input type="button" value="Delete"/> |        |        |             |                                 |    |                                                                           |     |     |     |                                                                           |     |     |     |                                                                           |
| Upload PKCS12 Certificate | <p>It allows users to import the certificate whose extensions are usually .pfx or .p12. And these certificates usually need passwords.<br/>                     Note that PKCS12 is a standard for storing private keys and certificates securely. It is used in (among other things) Netscape and Microsoft Internet Explorer with their import and export options.<br/>                     PKCS12 file - Click Browse to select a PKCS12 certificate file.<br/>                     Password - Enter the password associated with the certificate and key files.<br/>                     Import - Click to import selected certificate file to router.</p>                                                                                                                                                                                                                                                                                                                                                                                                                                                                                                                                                                                                                                                                                                                                                                                                                                                                                                                                                                                                                                                                                                                                                                                                |        |                                                                           |        |        |             |                                 |    |                                                                           |     |     |     |                                                                           |     |     |     |                                                                           |

|                                    |                                                                                                                                                                                                                                                                                                                                                                                                                                                                                                         |
|------------------------------------|---------------------------------------------------------------------------------------------------------------------------------------------------------------------------------------------------------------------------------------------------------------------------------------------------------------------------------------------------------------------------------------------------------------------------------------------------------------------------------------------------------|
|                                    | Cancel - Click to return to the main Local Certificate screen.                                                                                                                                                                                                                                                                                                                                                                                                                                          |
| Upload Certificate and Private Key | <p>It is useful when users have separated certificates and private keys. And the password is needed if the private key is encrypted.</p> <p>Certificate file - Click Browse to select a local certificate file.</p> <p>Key file - Click Browse to select a key file.</p> <p>Password - Enter the password associated with the certificate and key files.</p> <p>Import - Click to import selected certificate file to router.</p> <p>Cancel - Click to return to the main Local Certificate screen.</p> |

## V-2-2 Trusted CA Certificate

The user can build RootCA certificates (up to three) if required.

When the local client and remote client are required to make certificate authentication (e.g., IPsec X.509) for data passing through SSL tunnel and avoiding the attack of MITM, a trusted root certificate authority (Root CA) will be used to authenticate the digital certificates offered by both ends.

However, the procedure of applying digital certificate from a trusted root certificate authority is complicated and time-consuming. Therefore, Vigor router offers a mechanism which allows you to generate root CA to save time and provide convenience for general user. Later, such root CA generated by DrayTek server can perform the issuing of local certificate.



### Info

Root CA can be deleted but not edited. If you want to modify the settings for a Root CA, please delete the one and create another one by clicking Create Root CA.

Create, import or export, view root the trusted certificate authority certificates on this page.

### No Root CA Existed

Certificate Management >> Trusted CA Certificate

#### X509 Trusted CA Certificate Configuration

| Name   | Subject | Status | Modify         |
|--------|---------|--------|----------------|
| ---    | ---     | ---    | Create Root CA |
| IMPORT |         |        |                |

#### Storage for Certificate

|               |   |                                                              |    |
|---------------|---|--------------------------------------------------------------|----|
| Storage Usage | : | <div style="width: 8%;"><div style="width: 8%;"></div></div> | 8% |
|---------------|---|--------------------------------------------------------------|----|

#### Note:

1. Please setup the "System Maintenance >> **Time and Date**" correctly before you try to generate a RootCA!!
2. The Time Zone MUST be setup correctly!!
3. Local Certificate and Trusted CA Certificate share a storage space.

REFRESH

### A Root CA Existed

Certificate Management >> Trusted CA Certificate

#### X509 Trusted CA Certificate Configuration

| Name    | Subject                                | Status          | Modify             |
|---------|----------------------------------------|-----------------|--------------------|
| Root CA | C = TW, ST = HS, L = SF, O = DrayTe... | ● Not Valid Yet | Export View Delete |
| IMPORT  |                                        |                 |                    |

#### Storage for Certificate

|               |   |                                                                |     |
|---------------|---|----------------------------------------------------------------|-----|
| Storage Usage | : | <div style="width: 11%;"><div style="width: 11%;"></div></div> | 11% |
|---------------|---|----------------------------------------------------------------|-----|

#### Note:

1. Please setup the "System Maintenance >> **Time and Date**" correctly before you try to generate a RootCA!!
2. The Time Zone MUST be setup correctly!!
3. Local Certificate and Trusted CA Certificate share a storage space.

REFRESH

Available settings are explained as follows:

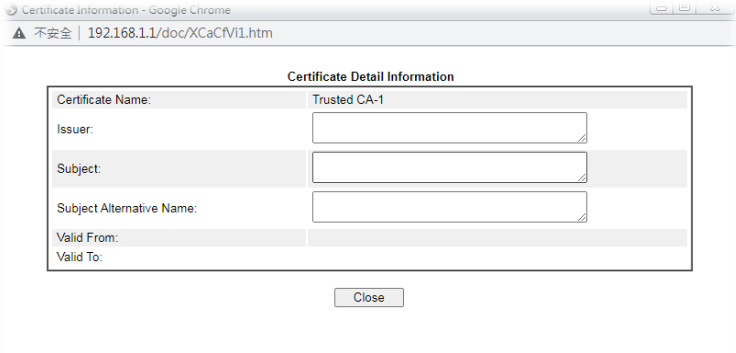
| Item           | Description                                                                                                                                                                                                                                                                                                                                                                                                                                                                                                                                                                  |
|----------------|------------------------------------------------------------------------------------------------------------------------------------------------------------------------------------------------------------------------------------------------------------------------------------------------------------------------------------------------------------------------------------------------------------------------------------------------------------------------------------------------------------------------------------------------------------------------------|
| Create Root CA | Click to create a new root CA.                                                                                                                                                                                                                                                                                                                                                                                                                                                                                                                                               |
| Name           | Name that identifies the certificate.                                                                                                                                                                                                                                                                                                                                                                                                                                                                                                                                        |
| Subject        | Shows the Subject Name of the certificate.                                                                                                                                                                                                                                                                                                                                                                                                                                                                                                                                   |
| Status         | Displays the status of the certificate.                                                                                                                                                                                                                                                                                                                                                                                                                                                                                                                                      |
| Modify         | <p>When none root CA existed:</p> <ul style="list-style-type: none"> <li>● Create Root CA - Click to fill out details about a certificate, and start the generation process.</li> </ul> <p>When a root CA existed:</p> <ul style="list-style-type: none"> <li>● Export - Click to export the certificate as a file.</li> <li>● View - Click to view details of the certificate.</li> </ul>  <ul style="list-style-type: none"> <li>● Delete - Click to delete the certificate.</li> </ul> |
| Import         | Click to import an existing certificate.                                                                                                                                                                                                                                                                                                                                                                                                                                                                                                                                     |
| Refresh        | Click to refresh the page to display the latest certificate information.                                                                                                                                                                                                                                                                                                                                                                                                                                                                                                     |

## Creating a Root CA

Click Create Root CA to open the following page.



## Generate Root CA

|                                 |                                                               |
|---------------------------------|---------------------------------------------------------------|
| <b>Certificate Name</b>         | Root CA <input type="button" value="Fill the default value"/> |
| <b>Subject Alternative Name</b> |                                                               |
| Type                            | IP Address ▼                                                  |
| IP                              | <input type="text"/>                                          |
| <b>Subject Name</b>             |                                                               |
| Country (C)                     | <input type="text"/>                                          |
| State (ST)                      | <input type="text"/>                                          |
| Location (L)                    | <input type="text"/>                                          |
| Organization (O)                | <input type="text"/>                                          |
| Organization Unit (OU)          | <input type="text"/>                                          |
| Common Name (CN)                | <input type="text"/>                                          |
| Email (E)                       | <input type="text"/>                                          |
| <b>Key Type</b>                 | RSA ▼                                                         |
| <b>Key Size</b>                 | 1024 Bit ▼                                                    |
| <b>Algorithm</b>                | SHA-256 ▼                                                     |

Available settings are explained as follows:

| Item                   | Description                                                                                                 |
|------------------------|-------------------------------------------------------------------------------------------------------------|
| Certificate Name       | Display the name of root CA.<br>Fill the default value - Click to enter the default value for this Root CA. |
| Type                   | Select the type of Subject Alternative Name and enter its value.                                            |
| Country (C)            | Country in which your organization is located.                                                              |
| State (ST)             | State or province where your organization is located.                                                       |
| Location (L)           | City where your organization is located.                                                                    |
| Organization (O)       | Legal name of your organization.                                                                            |
| Organization Unit (OU) | Department within your organization that you wish to be associated with this certificate.                   |
| Common Name (CN)       | Fully-qualified domain name / WAN IP that will be used to reach your server.                                |
| Email (E)              | Email address of the entry.                                                                                 |
| Key Type               | Key type is hard set to RSA.                                                                                |
| Key Size               | Choose between 1024 and 2048 bit.                                                                           |
| Algorithm              | Choose between SHA-1 and SHA-256.                                                                           |
| Generate               | Click to submit generate request to the CA server.                                                          |

### Importing a Trusted CA

To import a pre-saved trusted CA certificate, please click **IMPORT** to open the following window.

**Import X509 Trusted CA Certificate**

Select a trusted CA certificate file.

Click [Import](#) to upload the certification.

Available settings are explained as follows:

| Item   | Description                                                                                                                    |
|--------|--------------------------------------------------------------------------------------------------------------------------------|
| Browse | Click Browse to select a CA certificate file.                                                                                  |
| Import | Click to import selected certificate file to router. The one you imported will be listed on the Trusted CA Certificate window. |
| Cancel | Click to return to the main Trusted CA Certificate screen.                                                                     |

## V-2-3 Certificate Backup

You can back up Local and Trusted CA certificates on the router to a file.

Certificate Management >> Certificate Backup

### Certificate Backup / Restoration

#### Backup

Encrypt password:

Confirm password:

Click  to download certificates to your local PC as a file.

#### Restoration

Select a backup file to restore.

未選擇任何檔案

Decrypt password:

Click  to upload the file.

Available settings are explained as follows:

| Item                              | Description                                                        |
|-----------------------------------|--------------------------------------------------------------------|
| Backup                            |                                                                    |
| Encrypt password/Confirm password | Enter the password with which you wish to encrypt the certificate. |
| Backup                            | Click to download the certificate.                                 |
| Restoration                       |                                                                    |
| Select a backup file to restore   | Click Browse to select the backup file you wish to restore.        |
| Decrypt password                  | Enter the password that was used to encrypt the certificates.      |
| Restore                           | Click to retrieve the certificate.                                 |

## V-2-4 Self-Signed Certificate

A self-signed certificate is a *unique* identification for the device (e.g., Vigor router) which generates the certificate by itself to ensure the router security. Such self-signed certificate is signed with its own private key.

The self-signed certificate will be applied in SSL VPN, HTTPS, and so on. In addition, it can be created for free by using a wide variety of tools.

Certificate Management >> Self-Signed Certificate

### Self-Signed Certificate Information

|                            |                                                                                                                                                                                                                                                                                                                                                                                                                                                                                                                                                                                                                                                                                                                                                                                                  |
|----------------------------|--------------------------------------------------------------------------------------------------------------------------------------------------------------------------------------------------------------------------------------------------------------------------------------------------------------------------------------------------------------------------------------------------------------------------------------------------------------------------------------------------------------------------------------------------------------------------------------------------------------------------------------------------------------------------------------------------------------------------------------------------------------------------------------------------|
| Certificate Name :         | self-signed                                                                                                                                                                                                                                                                                                                                                                                                                                                                                                                                                                                                                                                                                                                                                                                      |
| Issuer :                   | C=TW, ST=HsinChu, L=HuKou, O=DrayTek Corp., OU=DrayTek Support, CN=Vigor Router                                                                                                                                                                                                                                                                                                                                                                                                                                                                                                                                                                                                                                                                                                                  |
| Subject :                  | C=TW, ST=HsinChu, L=HuKou, O=DrayTek Corp., OU=DrayTek Support, CN=Vigor Router                                                                                                                                                                                                                                                                                                                                                                                                                                                                                                                                                                                                                                                                                                                  |
| Subject Alternative Name : | DNS:www.draytek.com                                                                                                                                                                                                                                                                                                                                                                                                                                                                                                                                                                                                                                                                                                                                                                              |
| Valid From :               | Jul 7 11:50:06 2020 GMT                                                                                                                                                                                                                                                                                                                                                                                                                                                                                                                                                                                                                                                                                                                                                                          |
| Valid To :                 | Jul 7 11:50:06 2022 GMT                                                                                                                                                                                                                                                                                                                                                                                                                                                                                                                                                                                                                                                                                                                                                                          |
| PEM Format Content :       | <pre>-----BEGIN CERTIFICATE----- MIIDPjCCAo6gAwIBAgIJAM5Q46fLi+1oMA0GCSqGSIb3DQEBCwUAMHgxCzAJBg NV BAYTA1RXMRAdDgYDVQIDAdIc2luQ2h1MQ4wDAYDVQQHDAVIdUtvvdTEwMBQGA1 UE CgwNRHJheVR1ayBDb3JwLjEYMBYGA1UECwwPRHJheVR1ayBTRdXBwb3J0MRUwEw YD VQQDDAxwaWdvciB3b3V0ZXIwHhcNMjAwNzA3MTE1MDA2WhcNMjIwNzA3MTE1MD A2 WjB4MQswCQYDVQQGEwJUVzEQMA4GA1UECAwHSHNpbkNodTEOMAAGA1UEBwwFSH VL b3UxYjAUBgNVBAoMDURyYXl1ZlZwYXN0Q29ycC4xGDAwBgNVBAAsMD0RyYXl1ZlZw Vw cG9ydDEVMBMGA1UEAwwMlmb3JwLjEUMjAwNzA3MTE1MDA2WhcNMjIwNzA3MTE1MD OC AQ8AMIIBCgKCAQEAE0QFcz9DSwors6ExtdyTRkposUi2mNmwlvfIJTdlK95yoBW 41 FnPZnm3UYvc0gVVwWR7jnb90Q/CEMNaLBz0tvlyjKo0tCF2+aXB3aUvKZmd6LY Iw b5WZl7DvKde3D7sTBGh1W/V0sLKIC260ZuY0vQB6NtzSrXNYQ+X2SOZvL9wbmb yS N1pIYgyjlLDpHrDHOwPAFQLn//ij/XZFq7Z00yyyFEtk9Rfms6NPbFbJA/w1v7</pre> |

#### Note:

1. Please setup the [System Maintenance >> Time and Date](#) correctly before you try to regenerate a self-signed certificate!!
2. The Time Zone MUST be setup correctly!!

Regenerate

Click Regenerate to open the Regenerate Self-Signed Certificate window. Enter all requested information including certificate name (used to differentiate different certificates), subject alternative name type and relational settings for subject name. Then click GENERATE.

## V-2-5 Local Services List

This page shows certificate used by local services. Users can click to create self-signed certificate..

Certificate Management >> Local Services List

Default Certificate

| Certificate Name    | Local Services                                                   |
|---------------------|------------------------------------------------------------------|
| Default Certificate | Router Management -- Web Access from LAN or WAN                  |
|                     | Router Management -- SSH                                         |
|                     | VPN and Remote Access >> LAN to LAN -- SSL VPN                   |
|                     | VPN and Remote Access >> Remote Dial-in User -- SSL VPN          |
|                     | <b><u>VPN and Remote Access &gt;&gt; OpenVPN -- OpenVPN</u></b>  |
|                     | Hotspot Web Portal                                               |
|                     | <b><u>Applications &gt;&gt; Internal RADIUS</u></b>              |
|                     | <b><u>Applications &gt;&gt; Local 802.1X General Setup</u></b>   |
|                     | Applications >> High Availability                                |
|                     | CSM >> DNS Filter -- block page                                  |
|                     | USB Application >> USB User Management                           |
| server              |                                                                  |
| None                | <b><u>VPN and Remote Access &gt;&gt; IPsec General Setup</u></b> |

OK

This page is left blank.

# Part VI Security



Firewall



CSM

While the broadband users demand more bandwidth for multimedia, interactive applications, or distance learning, security has been always the most concerned. The firewall of the Vigor router helps to protect your local network against attack from unauthorized outsiders. It also restricts users in the local network from accessing the Internet.

CSM is an abbreviation of Central Security Management which is used to control IM/P2P usage, filter the web content and URL content to reach a goal of security management.

---

## VI-1 Firewall

### Basic

A network firewall monitors traffic travelling between networks, with the ability to selectively allow or block traffic using a predefined set of security rules. This helps to maintain the integrity of networks by stopping unauthorized access and the exchange of sensitive information.

### Firewall Facilities

LAN users are provided with secured protection by the following firewall facilities:

- User-configurable IP filter (Data Filter).
- Stateful Packet Inspection (SPI): tracks packets and denies unsolicited incoming data
- Selectable Denial of Service (DoS) /Distributed DoS (DDoS) attacks protection

### Data Filter

All traffic, both incoming and outgoing, that does not trigger a PPP connection attempt (either because a PPP connection is not necessary, or the required PPP connection has already been established) is checked against the Data Filter, and will be allowed or blocked according to the rules configured within.

The following flowcharts show how the router treats incoming traffic and outgoing traffic respectively.

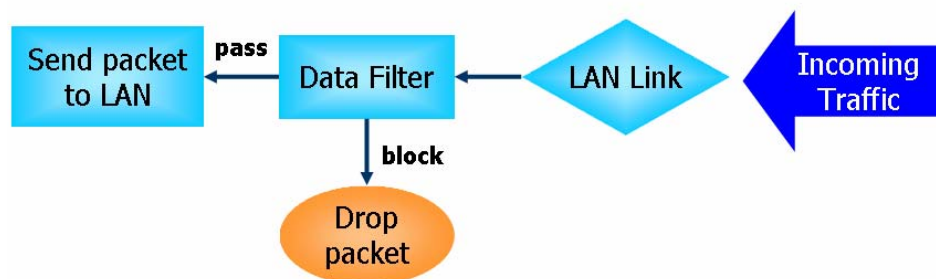

### Stateful Packet Inspection (SPI)

Stateful inspection is a firewall architecture that works at the network layer. Unlike legacy static packet filtering, which examines a packet based on the information in its header, stateful inspection builds up a state machine to track each connection traversing all interfaces of the firewall and makes sure they are valid. The stateful firewall of Vigor router not only examines the header information also monitors the state of the connection.

### Denial of Service (DoS) Defense

DoS attacks are categorized into two types: flooding-type attacks and vulnerability attacks. Flooding-type attacks attempts to exhaust system resources while vulnerability attacks attempts to paralyze the system by exploiting vulnerabilities of protocols or operation systems.



Vigor's DoS Defense functionality detects DoS attacks and mitigates their damage by inspecting every incoming packet, and malicious packets will be blocked. If Syslog is enabled, alert messages will also be sent. Abnormal traffic flow such as flood and port scan attacks that exceed allowable thresholds are also blocked.

The below shows the attack types that DoS/DDoS defense function can detect:

1. SYN flood attack
2. UDP flood attack
3. ICMP flood attack
4. Port Scan attack
5. IP options
6. Land attack
7. Smurf attack
8. Trace route
9. SYN fragment
10. Fraggle attack
11. TCP flag scan
12. Tear drop attack
13. Ping of Death attack
14. ICMP fragment
15. Unassigned Numbers

# Web User Interface

Below shows the menu items for Firewall.

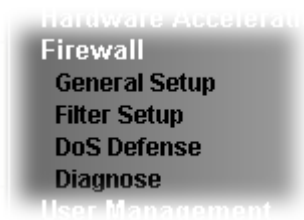

## VI-1-1 General Setup

### General Setup Page

Such page allows you to enable / disable Data Filter, determine general rule for filtering the incoming and outgoing data.

Firewall >> General Setup

General Setup

General Setup

Default Rule

Data Filter  Enable  Disable

Start Filter Set Set#1 ▼

---

Allow pass inbound fragmented large packets (required for certain games and streaming)

Enable Strict Security Firewall

Block routing connections initiated from WAN  IPv4  IPv6

**Note:**

Packets are filtered by firewall functions in the following order:  
 1.Data Filter Sets and Rules 2.Block routing connections initiated from WAN 3.Default Rule

|                                                            |                                                                                                                            |
|------------------------------------------------------------|----------------------------------------------------------------------------------------------------------------------------|
| Backup Firewall :<br><input type="button" value="Backup"/> | Restore Firewall: <input type="button" value="選擇檔案"/> 未選擇任何檔案 <input style="float: right;" type="button" value="Restore"/> |
|------------------------------------------------------------|----------------------------------------------------------------------------------------------------------------------------|

**Note:**

This will not backup the detail setting of Quality of Service and Schedule.

Available settings are explained as follows:

| Item        | Description                                                                             |
|-------------|-----------------------------------------------------------------------------------------|
| Data Filter | Select Enable to activate the Data Filter function, and then choose a Start Filter Set. |

|                                                            |                                                                                                                                                                                                                                                                                                                                                                                                                                                                                                                                   |
|------------------------------------------------------------|-----------------------------------------------------------------------------------------------------------------------------------------------------------------------------------------------------------------------------------------------------------------------------------------------------------------------------------------------------------------------------------------------------------------------------------------------------------------------------------------------------------------------------------|
| <p><b>Always pass inbound fragmented large packets</b></p> | <p>Certain games and video streaming service use fragmented UDP packets to transfer data. Enabling this option allows these applications to function properly.</p> <p>If this option is not enabled, the router will attempt to reassemble fragmented packets up to a certain value (e.g., 15xx-2102) kilobytes long. Packets larger than the certain value will be discarded.</p> <p>If this option is enabled, the router always passes fragmented packets without reassembling them, regardless of the size of the packet.</p> |
| <p><b>Enable Strict Security Firewall</b></p>              | <p>If this option and the Web Content Filter (WCF) are both enabled, web traffic will be blocked if the WCF server fails to respond to lookup requests.</p>                                                                                                                                                                                                                                                                                                                                                                       |
| <p><b>Block routing connections initiated from WAN</b></p> | <p>IPv6 - IPv6 does not make use of Network Address Translation (NAT), so all LAN hosts receive public IPv6 IP addresses that are exposed to the WAN. Enable this option to block WAN hosts from connecting to LAN hosts using IPv6.</p> <p>IPv4 - For LAN hosts receiving WAN IPv4 addresses using the IP routed subnet, enable this option to prevent WAN hosts from connecting to LAN hosts. This option has no effect on LAN hosts on private LAN subnets.</p>                                                                |
| <p><b>Backup Firewall</b></p>                              | <p>Click <b>Backup</b> to save the firewall configuration.</p>                                                                                                                                                                                                                                                                                                                                                                                                                                                                    |
| <p><b>Restore Firewall</b></p>                             | <p>Click <b>Select</b> to choose a firewall configuration file. Then click <b>Restore</b> to apply the file.</p>                                                                                                                                                                                                                                                                                                                                                                                                                  |

To save changes on the page, click **OK**. To discard changes, click **Cancel**.

Traffic is filtered by firewall functions in the following order:

1. Data Filter Sets and Rules
2. Block connections initiated from WAN
3. Default Rule

## Default Rule Page

Such page allows you to choose filtering profiles including QoS, Load-Balance policy, WCF, APP Enforcement, URL Content Filter, for data transmission via Vigor router.

The default rule applies to all traffic that is not constrained by other filters or rules.

Firewall >> General Setup

General Setup

General Setup

Default Rule

**Actions for default rule:**

| Application               | Action/Profile                                              | Syslog                   |
|---------------------------|-------------------------------------------------------------|--------------------------|
| Filter                    | Pass <input type="button" value="v"/>                       | <input type="checkbox"/> |
| Sessions Control          | 0 / <input style="width: 50px;" type="text" value="60000"/> | <input type="checkbox"/> |
| <u>Quality of Service</u> | None <input type="button" value="v"/>                       | <input type="checkbox"/> |
| <u>User Management</u>    | None <input type="button" value="v"/>                       | <input type="checkbox"/> |
| <u>APP Enforcement</u>    | None <input type="button" value="v"/>                       | <input type="checkbox"/> |
| <u>URL Content Filter</u> | None <input type="button" value="v"/>                       | <input type="checkbox"/> |
| <u>Web Content Filter</u> | None <input type="button" value="v"/>                       | <input type="checkbox"/> |
| <u>DNS Filter</u>         | None <input type="button" value="v"/>                       | <input type="checkbox"/> |

---

Advance Setting

|                                                            |                                                                                  |                                        |
|------------------------------------------------------------|----------------------------------------------------------------------------------|----------------------------------------|
| Backup Firewall :<br><input type="button" value="Backup"/> | Restore Firewall: <input style="width: 50px;" type="text" value="選擇檔案"/> 未選擇任何檔案 | <input type="button" value="Restore"/> |
|------------------------------------------------------------|----------------------------------------------------------------------------------|----------------------------------------|

**Note:**

This will not backup the detail setting of Quality of Service and Schedule.

Available settings are explained as follows:

| Item               | Description                                                                                                                                                                                                                                                                                                                                                  |
|--------------------|--------------------------------------------------------------------------------------------------------------------------------------------------------------------------------------------------------------------------------------------------------------------------------------------------------------------------------------------------------------|
| Filter             | Select Pass or Block for the packets that do not match with the filter rules. When the setting is Block, all other fields on the page are disabled because they are not applicable.                                                                                                                                                                          |
| Sessions Control   | The current number of sessions is shown before the slash, followed by the maximum number of concurrent sessions allowed, which is configurable. The default maximum is 60000, which is also the upper limit of the value.                                                                                                                                    |
| Quality of Service | Choose one of the QoS rules to be applied as firewall rule. For detailed information of setting QoS, please refer to the related section later.                                                                                                                                                                                                              |
| User Management    | This setting is only available when Rule-Based is selected in User Management>>General Setup. The default firewall rule will be applied to the selected user or user group. Refer to the chapter on User Management for more details on the feature. <ul style="list-style-type: none"> <li>● None: User Management does not apply to the default</li> </ul> |

|                    |                                                                                                                                                                                                                                                                                                                                                                                                                                                                                                                                                                                                                                                                |
|--------------------|----------------------------------------------------------------------------------------------------------------------------------------------------------------------------------------------------------------------------------------------------------------------------------------------------------------------------------------------------------------------------------------------------------------------------------------------------------------------------------------------------------------------------------------------------------------------------------------------------------------------------------------------------------------|
|                    | <p>rule.</p> <ul style="list-style-type: none"> <li>● User Object: The default rule only applies to the selected user.</li> <li>● [Create New User]: Select this to create a new user.</li> <li>● User Group: The default rule only applies to the selected User Group.</li> <li>● [Create New Group]: Select this to create a new user group.</li> <li>● ALL: The default rule applies to all defined users.</li> <li>● Create New User or Create New Group item will appear for you to click to create a new one if there is no user profile or group profile existed.</li> </ul> <p>Syslog - Select to allow User Management to log messages in Syslog.</p> |
| APP Enforcement    | <p>Select an APP Enforcement profile for application blocking, or None to disable APP Enforcement for the Default Rule. Select [Create New] from the dropdown list to create a new profile. Refer to the chapter on APP Enforcement for more details on the feature.</p> <p>Syslog - Select to allow APP Enforcement to log messages in Syslog.</p>                                                                                                                                                                                                                                                                                                            |
| URL Content Filter | <p>Select a URL Content Filter profile to be used, or None to disable URL Content Filter for the Default Rule. Select [Create New] from the dropdown list to create a new profile. Refer to the chapter on URL Content Filter for more details on the feature.</p> <p>Syslog - Select to allow URL Content Filter to log messages in Syslog. Logging action is configured at the profile level in CSM&gt;&gt;URL Content Filter Profile, Log.</p>                                                                                                                                                                                                              |
| Web Content Filter | <p>Select a Web Content Filter profile to be used, or None to disable Web Content Filter for the Default Rule. Select [Create New] from the dropdown list to create a new profile.</p> <p>Syslog - Select to allow Web Content Filter to log messages in Syslog. Logging action is configured at the profile level in the Web Content Filter Profile Table section in CSM&gt;&gt;Web Content Filter Profile, Log.</p>                                                                                                                                                                                                                                          |
| DNS Filter         | <p>Select the DNS Filter profile to be used, or None to disable DNS Filter for the Default Rule. Select [Create New] from the dropdown list to create a new profile.</p> <p>Syslog - Select to allow DNS Filter to log messages in Syslog. Logging action is configured at the profile level in the DNS Filter Profile Table section in CSM&gt;&gt;DNS Filter Profile, SysLog.</p>                                                                                                                                                                                                                                                                             |
| Advance Setting    | <p>Click Edit to open the configuration window for Advanced Settings. However, it is recommended to use the default settings.</p>                                                                                                                                                                                                                                                                                                                                                                                                                                                                                                                              |

Firewall >> General Setup

|                  |                    |
|------------------|--------------------|
| Advance Setting  |                    |
| Codepage         | ANSI(1252)-Latin I |
| Window size:     | 65535              |
| Session timeout: | 60 Minute          |

OK Close

Codepage - Sets the codepage used by the URL content filter to match URLs against keywords in profiles. Choosing the appropriate codepage can increase the accuracy of the URL Content Filter. The default value is ANSI 1252 Latin I. If the setting is None, no decoding of URL will be performed.

If you are unsure of which codepage to use, please start the Syslog application, and the recommended codepage will be shown in the Codepage Information tab in the Setup dialog box.

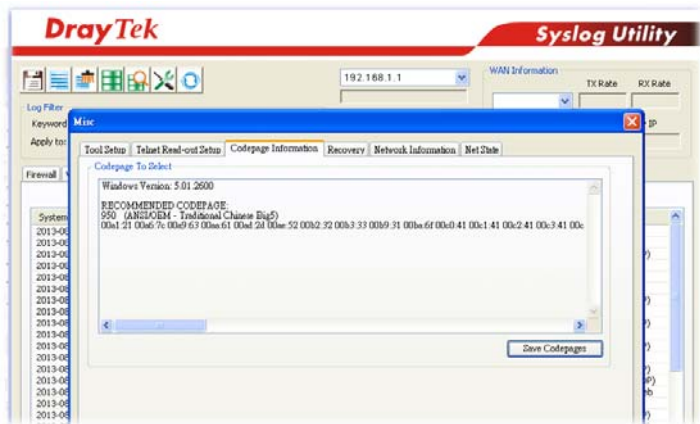

Window size - Sets the TCP window size as described in RFC 1323. Valid values are from 0 to 65535. The more the value is, the better the performance will be. However, if the network is not stable, small value will be proper.

Session timeout - Sets the timeout sessions are allowed to idle before they are removed from the system.

|                  |                                                                                             |
|------------------|---------------------------------------------------------------------------------------------|
| Backup Firewall  | Click Backup to save the firewall configuration.                                            |
| Restore Firewall | Click Select to choose a firewall configuration file. Then click Restore to apply the file. |

After finishing all the settings here, please click OK to save the configuration.

## VI-1-2 Filter Setup

Click Firewall and click Filter Setup to bring up the setup page.

Firewall >> Filter Setup



| Filter Setup       |                     | <a href="#">Set to Factory Default</a> |          |
|--------------------|---------------------|----------------------------------------|----------|
| Set                | Comments            | Set                                    | Comments |
| <a href="#">1.</a> | Default Data Filter | <a href="#">7.</a>                     |          |
| <a href="#">2.</a> |                     | <a href="#">8.</a>                     |          |
| <a href="#">3.</a> |                     | <a href="#">9.</a>                     |          |
| <a href="#">4.</a> |                     | <a href="#">10.</a>                    |          |
| <a href="#">5.</a> |                     | <a href="#">11.</a>                    |          |
| <a href="#">6.</a> |                     | <a href="#">12.</a>                    |          |

To edit a filter set, click on its set number. The following Filter Set page will be shown. Each filter set contains up to 7 rules.

Firewall >> Filter Setup >> Edit Filter Set

Filter Set 1  
 Comments :

| Rule | Enable                              | Comments        | Direction             | Src IP | Dst IP | Service Type                      | Action            | CSM | Move Up            | Move Down            |
|------|-------------------------------------|-----------------|-----------------------|--------|--------|-----------------------------------|-------------------|-----|--------------------|----------------------|
| 1    | <input checked="" type="checkbox"/> | xNetBios -> DNS | LAN/DMZ/RT/VPN -> WAN | Any    | Any    | TCP/UDP, Port: from 137~139 to 53 | Block Immediately |     |                    | <a href="#">Down</a> |
| 2    | <input type="checkbox"/>            |                 | LAN/DMZ/RT/VPN -> WAN | Any    | Any    | Any                               | Pass Immediately  |     | <a href="#">Up</a> | <a href="#">Down</a> |
| 3    | <input type="checkbox"/>            |                 | LAN/DMZ/RT/VPN -> WAN | Any    | Any    | Any                               | Pass Immediately  |     | <a href="#">Up</a> | <a href="#">Down</a> |
| 4    | <input type="checkbox"/>            |                 | LAN/DMZ/RT/VPN -> WAN | Any    | Any    | Any                               | Pass Immediately  |     | <a href="#">Up</a> | <a href="#">Down</a> |
| 5    | <input type="checkbox"/>            |                 | LAN/DMZ/RT/VPN -> WAN | Any    | Any    | Any                               | Pass Immediately  |     | <a href="#">Up</a> | <a href="#">Down</a> |
| 6    | <input type="checkbox"/>            |                 | LAN/DMZ/RT/VPN -> WAN | Any    | Any    | Any                               | Pass Immediately  |     | <a href="#">Up</a> | <a href="#">Down</a> |
| 7    | <input type="checkbox"/>            |                 | LAN/DMZ/RT/VPN -> WAN | Any    | Any    | Any                               | Pass Immediately  |     | <a href="#">Up</a> |                      |

Filter Set [1](#) [2](#) [3](#) [4](#) [5](#) [6](#) [7](#) [8](#) [9](#) [10](#) [11](#) [12](#) Next Filter Set

Wizard Mode: most frequently used settings in three pages  
 Advance Mode: all settings in one page

Available settings are explained as follows:

| Item            | Description                                                                                                                                                      |
|-----------------|------------------------------------------------------------------------------------------------------------------------------------------------------------------|
| Filter Rule     | To edit the filter rule, click the filter rule number to bring up the Edit Filter Rule page. See the following section for details on the Edit Filter Rule page. |
| Enable          | Select to enable the filter rule.                                                                                                                                |
| Comments        | Optional comment entered in the settings page to identify the rule.                                                                                              |
| Direction       | Displays the direction of packet.                                                                                                                                |
| Src IP / Dst IP | Displays the IP address of source / destination.                                                                                                                 |
| Service Type    | Displays the type and port number of the packet.                                                                                                                 |

|                 |                                                                                                                                                                                                                   |
|-----------------|-------------------------------------------------------------------------------------------------------------------------------------------------------------------------------------------------------------------|
| Action          | Displays the packets to be passed /blocked.                                                                                                                                                                       |
| CSM             | Displays the content security managed                                                                                                                                                                             |
| Move Up/Down    | Use Up or Down link to change the order of the filter rules.                                                                                                                                                      |
| Next Filter Set | Select the filter set for the firewall to process after the current filter set, or None if the current filter set is the last one to be processed. Be careful not to create a loop when setting next filter sets. |
| Wizard Mode     | Allow to configure frequently used settings for filter rule via several setting pages.                                                                                                                            |
| Advance Mode    | Allow to configure detailed settings of filter rule.                                                                                                                                                              |

To use Wizard Mode, simple do the following steps:

1. Click the Wizard Mode radio button.
2. Click Index 1. The setting page will appear as follows:

Firewall >> Edit Filter Set >> Edit Filter Rule Wizard

Filter Set 1 Rule 1

Firewall Rule applies to packets that meet the following criteria

Comments:

Direction:

Source IP:

Start IP Address

End IP Address

Subnet Mask

Destination IP:

Start IP Address

End IP Address

Subnet Mask

Protocol:

Source Port

Destination Port

Available settings are explained as follows:

| Item                  | Description                                                                                                                                              |
|-----------------------|----------------------------------------------------------------------------------------------------------------------------------------------------------|
| Comments              | Enter filter set comments/description. Maximum length is 14- character long.                                                                             |
| Direction             | Set the direction of packet flow.<br>Note: RT means routing domain for 2nd subnet or other LAN.                                                          |
| Source/Destination IP | To set the IP address manually, please choose Any Address/Single Address/Range Address/Subnet Address as the Address Type and Enter them in this dialog. |
| Protocol              | Specify the protocol(s) which this filter rule will apply to.                                                                                            |



|                                |                                                                                                                                                                                                                                                                                                                                                                                                                                                                                                                                                                                                                                    |
|--------------------------------|------------------------------------------------------------------------------------------------------------------------------------------------------------------------------------------------------------------------------------------------------------------------------------------------------------------------------------------------------------------------------------------------------------------------------------------------------------------------------------------------------------------------------------------------------------------------------------------------------------------------------------|
| Source Port / Destination Port | <p>(=) - when the first and last value are the same, it indicates one port; when the first and last values are different, it indicates a range for the port and available for this service type.</p> <p>(!=) - when the first and last value are the same, it indicates all the ports except the port defined here; when the first and last values are different, it indicates that all the ports except the range defined here are available for this service type.</p> <p>(&gt;) - the port number greater than this value is available.</p> <p>(&lt;) - the port number less than this value is available for this profile.</p> |
|--------------------------------|------------------------------------------------------------------------------------------------------------------------------------------------------------------------------------------------------------------------------------------------------------------------------------------------------------------------------------------------------------------------------------------------------------------------------------------------------------------------------------------------------------------------------------------------------------------------------------------------------------------------------------|

- Click Next to get the following page.

Firewall >> Edit Filter Set >> Edit Filter Rule Wizard

Filter Set 1 Rule 1

Based on the settings in the previous pages, we guess you want to have: Pass

The current setting is :

Pass Immediately

APP Enforcement:

URL Content Filter:

Web Content Filter:

DNS Filter:

Block Immediately

Back Next Finish Cancel

Available settings are explained as follows:

| Item              | Description                                                                                                                                                                                                                                                                                                                                                                                                                                                                                                                                                                                                                                                                                                                                                                                                                                                                                                                                                                                                                                       |
|-------------------|---------------------------------------------------------------------------------------------------------------------------------------------------------------------------------------------------------------------------------------------------------------------------------------------------------------------------------------------------------------------------------------------------------------------------------------------------------------------------------------------------------------------------------------------------------------------------------------------------------------------------------------------------------------------------------------------------------------------------------------------------------------------------------------------------------------------------------------------------------------------------------------------------------------------------------------------------------------------------------------------------------------------------------------------------|
| Pass Immediately  | <p>Packets matching the rule will be passed immediately.</p> <p>APP Enforcement - Select an APP Enforcement profile for application blocking, or None to disable APP Enforcement for the Default Rule. Select [Create New] from the dropdown list to create a new profile. Refer to the chapter on APP Enforcement for more details on the feature.</p> <p>URL Content Filter - Select a URL Content Filter profile to be used, or None to disable URL Content Filter for the Default Rule. Select [Create New] from the dropdown list to create a new profile. Refer to the chapter on URL Content Filter for more details on the feature.</p> <p>Web Content Filter - Select a Web Content Filter profile to be used, or None to disable Web Content Filter for the Default Rule. Select [Create New] from the dropdown list to create a new profile.</p> <p>DNS Filter - Select the DNS Filter profile to be used, or None to disable DNS Filter for the Default Rule. Select [Create New] from the dropdown list to create a new profile.</p> |
| Block Immediately | Packets matching the rule will be dropped immediately.                                                                                                                                                                                                                                                                                                                                                                                                                                                                                                                                                                                                                                                                                                                                                                                                                                                                                                                                                                                            |

- After choosing the mechanism, click Next to get the summary page for reference.

Filter Set 1 Rule 1 Configuration Summary

|                       |                                     |      |
|-----------------------|-------------------------------------|------|
| Comments :            | xNetBios -> DNS                     |      |
| Direction             |                                     |      |
| LAN/DMZ/RT/VPN -> WAN |                                     |      |
| Criteria              |                                     |      |
| Source IP             | Any                                 |      |
| Destination IP        | Any                                 |      |
| Protocol              | TCP/UDP, Port: from 137 ~ 139 to 53 |      |
| More options          |                                     |      |
| Pass Immediately      |                                     |      |
|                       | APP Enforcement :                   | None |
|                       | URL Content Filter :                | None |
|                       | Web Content Filter :                | None |
|                       | DNS Filter :                        | None |

5. If there is no error, click Finish to complete wizard setting.

To use Advance Mode, do the following steps:

1. Click the Advance Mode radio button.
2. Click Index 1 to access into the following page.

Firewall >> Edit Filter Set >> Edit Filter Rule

Filter Set 1 Rule 1

Enable

Comments

Schedule Profile  ,  ,  ,

Clear sessions when schedule is ON

---

Direction

Source IP/Country

Destination IP/Country

Service Type

Fragments

---

| Application                | Action/Profile                                 | Syslog                   |
|----------------------------|------------------------------------------------|--------------------------|
| Filter                     | <input type="text" value="Block Immediately"/> | <input type="checkbox"/> |
| Branch to Other Filter Set | <input type="text" value="None"/>              | <input type="checkbox"/> |
| Sessions Control           | <input type="text" value="0 / 60000"/>         | <input type="checkbox"/> |
| MAC Bind IP                | <input type="text" value="Non-Strict"/>        | <input type="checkbox"/> |
| <u>Quality of Service</u>  | <input type="text" value="None"/>              | <input type="checkbox"/> |
| <u>User Management</u>     | <input type="text" value="None"/>              | <input type="checkbox"/> |
| <u>APP Enforcement</u>     | <input type="text" value="None"/>              | <input type="checkbox"/> |
| <u>URL Content Filter</u>  | <input type="text" value="None"/>              | <input type="checkbox"/> |
| <u>Web Content Filter</u>  | <input type="text" value="None"/>              | <input type="checkbox"/> |
| <u>DNS Filter</u>          | <input type="text" value="None"/>              | <input type="checkbox"/> |

Advance Setting

Available settings are explained as follows:

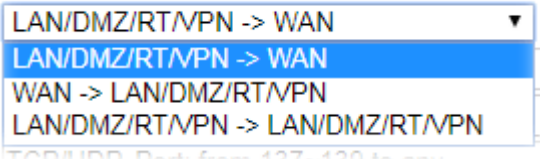
| Item                            | Description                                                                                                                                                                                                                             |
|---------------------------------|-----------------------------------------------------------------------------------------------------------------------------------------------------------------------------------------------------------------------------------------|
| Enable                          | Check this box to enable the filter rule.                                                                                                                                                                                               |
| Comments                        | Enter filter set comments/description. Maximum length is 14- character long.                                                                                                                                                            |
| Schedule Profile                | Select Schedule indexes to allow the rule to be enabled at specific times. You may choose up to 4 out of the 15 schedules in Applications >> Schedule. The rule is always enabled when no indexes have been selected.                   |
| Clear sessions when schedule ON | Select this option to clear existing sessions when the rule is changes is enabled by a schedule profile. All connections will be reset.                                                                                                 |
| Direction                       | Specify the direction of traffic flow to which this filter rule applies.<br><br>Note: RT stands for the routing domain for 2nd subnet or other LAN. |

Advanced - After choosing the direction, click the Advanced button to specify interfaces for traffic flow.

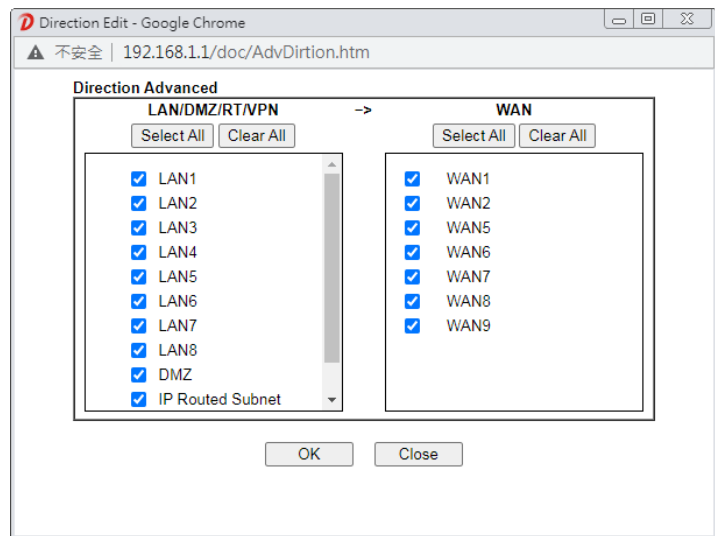

Source IP/ Country and Destination IP / Country

Click Edit to bring up the following dialog box to configure the source and destination IP addresses or country objects.

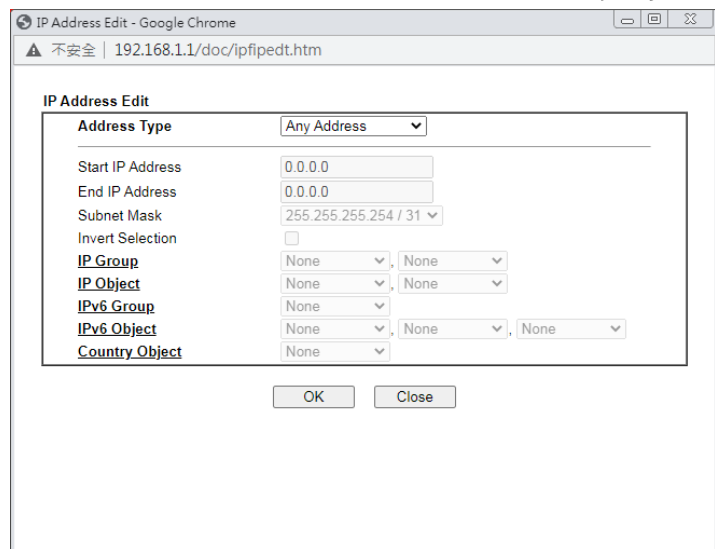

To set the IP address manually, please choose an Address Type and enter required information.

Address Type - Select from one of the following:

- Any Address - All IP addresses
- Single Address - Enter one IP address in Start IP address
- Range Address - Enter the Start and End IP Addresses
- Subnet Address - Enter the Start IP Address and the Subnet Mask. Example: Start IP Address 192.168.1.1 and Subnet Mask 255.255.255.128 means is the same as having the Start IP Address as 192.168.1.1 and the End IP Address as 192.168.1.127.
- Group and Objects - Allows selection of predefined IP Groups and IP Objects. For details on IP Groups and Objects, see the chapter on Objects Setting.
- Country Object - Allows selection of predefined country objects.

Service Type

Click Edit to bring up the following dialog box to configure

the Service Type.

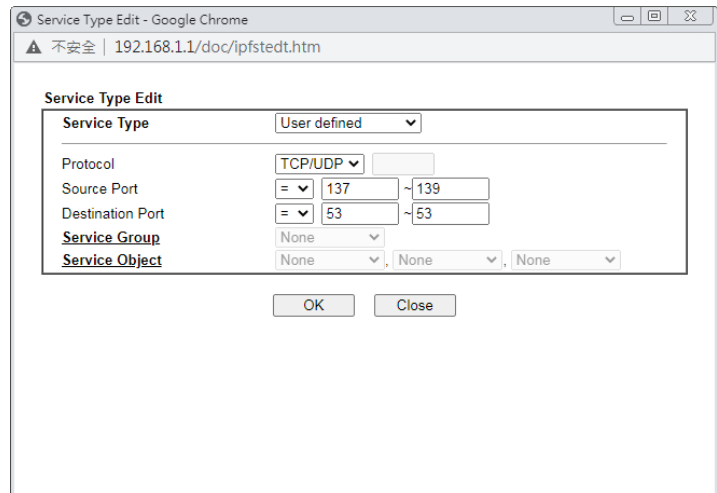

Service Type - To set the service type manually, please choose User defined as the Service Type.

- User defined - Configure the protocol, source and destination ports manually.
- Group and Objects - Select preconfigured Service Groups or Objects.

Protocol - Specify the protocol(s) which this filter rule will apply to.

Source/Destination Port -

- (=) - any port that falls within the specified range
- (!=) - any port that falls outside of the specified range
- (>) - a port whose number is greater than the specified value
- (<) - a port whose number is smaller than the specified value

Service Group/Object - Use the drop down list to select the desired Service Groups or Objects.

|                                   |                                                                                                                                                                                                                                                                                                                                                                                                                                                               |
|-----------------------------------|---------------------------------------------------------------------------------------------------------------------------------------------------------------------------------------------------------------------------------------------------------------------------------------------------------------------------------------------------------------------------------------------------------------------------------------------------------------|
| <p>Fragments</p>                  | <p>Action to be taken for fragmented packets. This option is valid for Data Filter rules only.</p> <ul style="list-style-type: none"> <li>● Don't care -No action will be taken towards fragmented packets.</li> <li>● Unfragmented -Apply the rule to unfragmented packets.</li> <li>● Fragmented - Apply the rule to fragmented packets.</li> <li>● Too Short - Apply the rule only to packets that are too short to contain a complete header.</li> </ul>  |
| <p>Filter</p>                     | <p>Action to be taken when packets match the rule.</p> <p>Block Immediately - Packets matching the rule will be dropped immediately.</p> <p>Pass Immediately - Packets matching the rule will be passed immediately.</p> <p>Block If No Further Match - Block the packet if this the last matching rule for this packet in the filter.</p> <p>Pass If No Further Match - Pass the packet if this is the last matching rule for this packet in the filter.</p> |
| <p>Branch to other Filter Set</p> | <p>If the packet matches the filter rule, and the Filter action is Block If No Further Match or Pass If No Further Match, you</p>                                                                                                                                                                                                                                                                                                                             |

|                    |                                                                                                                                                                                                                                                                                                                                                                                                                                                                                                                                                                                                                                                                                                                                                                                                                                                                                                                                                                      |
|--------------------|----------------------------------------------------------------------------------------------------------------------------------------------------------------------------------------------------------------------------------------------------------------------------------------------------------------------------------------------------------------------------------------------------------------------------------------------------------------------------------------------------------------------------------------------------------------------------------------------------------------------------------------------------------------------------------------------------------------------------------------------------------------------------------------------------------------------------------------------------------------------------------------------------------------------------------------------------------------------|
|                    | can specify the next filter set to be applied, thus skipping the rest of the rules in the current filter set.                                                                                                                                                                                                                                                                                                                                                                                                                                                                                                                                                                                                                                                                                                                                                                                                                                                        |
| Sessions Control   | The current number of sessions is shown before the slash, followed by the maximum number of concurrent sessions allowed, which is configurable. The default maximum is 60000, which is also the upper limit of the value.                                                                                                                                                                                                                                                                                                                                                                                                                                                                                                                                                                                                                                                                                                                                            |
| MAC Bind IP        | Strict - Ensure that both the MAC address and the IP address of the source and/or destination clients.<br>Non-Strict - Do not check the IP address when processing IP Objects that specify MAC addresses.                                                                                                                                                                                                                                                                                                                                                                                                                                                                                                                                                                                                                                                                                                                                                            |
| Quality of Service | Choose one of the QoS rules to be applied as firewall rule. For detailed information of setting QoS, please refer to the related section later.                                                                                                                                                                                                                                                                                                                                                                                                                                                                                                                                                                                                                                                                                                                                                                                                                      |
| User Management    | This setting is only available when Rule-Based is selected in User Management>>General Setup. The default firewall rule will be applied to the selected user or user group. Refer to the chapter on User Management for more details on the feature. <ul style="list-style-type: none"> <li>● None: User Management does not apply to the default rule.</li> <li>● User Object: The default rule only applies to the selected user.</li> <li>● [Create New User]: Select this to create a new user.</li> <li>● User Group: The default rule only applies to the selected User Group.</li> <li>● [Create New Group]: Select this to create a new user group.</li> <li>● ALL: The default rule applies to all defined users.</li> <li>● Create New User or Create New Group item will appear for you to click to create a new one if there is no user profile or group profile existed.</li> </ul> Syslog - Select to allow User Management to log messages in Syslog. |
| APP Enforcement    | Select an APP Enforcement profile for application blocking, or None to disable APP Enforcement for the Default Rule. Select [Create New] from the dropdown list to create a new profile. Refer to the chapter on APP Enforcement for more details on the feature.<br>Syslog - Select to allow APP Enforcement to log messages in Syslog.                                                                                                                                                                                                                                                                                                                                                                                                                                                                                                                                                                                                                             |
| URL Content Filter | Select a URL Content Filter profile to be used, or None to disable URL Content Filter for the Default Rule. Select [Create New] from the dropdown list to create a new profile. Refer to the chapter on URL Content Filter for more details on the feature.<br>Syslog - Select to allow URL Content Filter to log messages in Syslog. Logging action is configured at the profile level in CSM>>URL Content Filter Profile, Log.                                                                                                                                                                                                                                                                                                                                                                                                                                                                                                                                     |
| Web Content Filter | Select a Web Content Filter profile to be used, or None to disable Web Content Filter for the Default Rule. Select [Create New] from the dropdown list to create a new profile.<br>Syslog - Select to allow Web Content Filter to log messages in Syslog. Logging action is configured at the profile level in                                                                                                                                                                                                                                                                                                                                                                                                                                                                                                                                                                                                                                                       |

|            |                                                                                                                                                                                                                                                                                                                                                                   |
|------------|-------------------------------------------------------------------------------------------------------------------------------------------------------------------------------------------------------------------------------------------------------------------------------------------------------------------------------------------------------------------|
|            | the Web Content Filter Profile Table section in CSM>>Web Content Filter Profile, Log.                                                                                                                                                                                                                                                                             |
| DNS Filter | Select the DNS Filter profile to be used, or None to disable DNS Filter for the Default Rule. Select [Create New] from the dropdown list to create a new profile.<br>Syslog - Select to allow DNS Filter to log messages in Syslog. Logging action is configured at the profile level in the DNS Filter Profile Table section in CSM>>DNS Filter Profile, SysLog. |

**Advance Setting** Click Edit to open the configuration window for Advanced Settings. However, it is recommended to use the default settings.

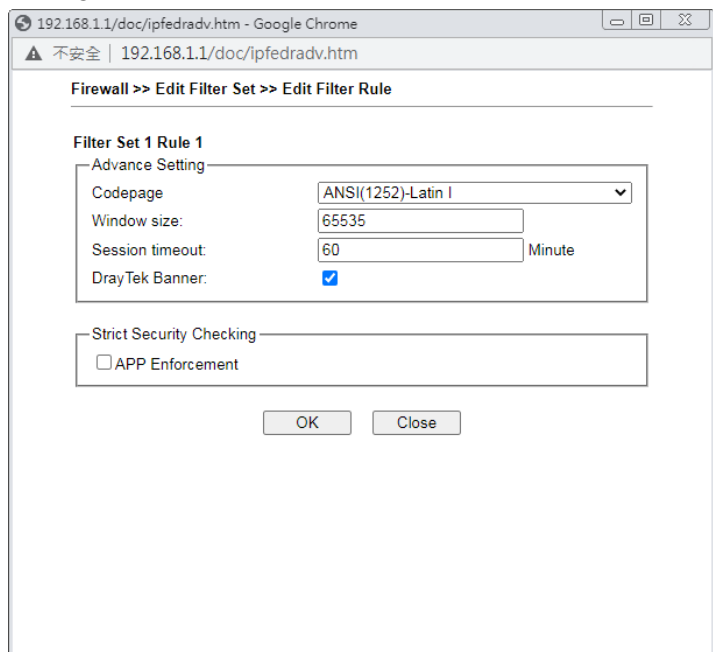

**Codepage** - Sets the codepage used by the URL content filter to match URLs against keywords in profiles. Choosing the appropriate codepage can increase the accuracy of the URL Content Filter. The default value is ANSI 1252 Latin I. If the setting is None, no decoding of URL will be performed.

If you are unsure of which codepage to use, please start the Syslog application, and the recommended codepage will be shown in the Codepage Information tab in the Setup dialog box.

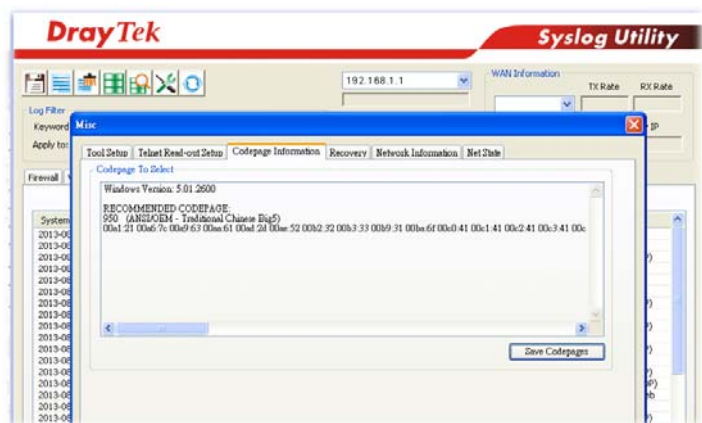

**Window size** - Sets the TCP window size as described in RFC 1323. Valid values are from 0 to 65535. The more the

---

value is, the better the performance will be. However, if the network is not stable, small value will be proper.

**Session timeout** - Sets the timeout sessions are allowed to idle before they are removed from the system.

**DrayTek Banner** - Select to display the following screen for web pages that are blocked by the Firewall. The default setting is Enabled.



#### **Strict Security Checking**

**APP Enforcement** - If this option is selected, when the router cannot identify the application that generated the outbound traffic due to limited system resources, the session will be blocked; if this option is not selected, the session will be allowed.

- 
3. When you finish the configuration, please click OK to save and exit this page.



## VI-1-3 Defense Setup

As a sub-functionality of IP Filter/Firewall, there are 15 types of detect/ defense function in the DoS Defense setup. The DoS Defense functionality is disabled for default.

### VI-1-3-1 DoS Defense

To configure DoS Defense, select DoS Defense under the Firewall menu item on the Web UI menu bar.

Firewall >> Defense Setup

| DoS Defense                                                                                                                                                                                                                                                            | Spoofing Defense                                                                                                                                                                                                                              |
|------------------------------------------------------------------------------------------------------------------------------------------------------------------------------------------------------------------------------------------------------------------------|-----------------------------------------------------------------------------------------------------------------------------------------------------------------------------------------------------------------------------------------------|
| <b>DoS defense</b><br><input type="checkbox"/> Enable DoS Defense <input type="button" value="Select All"/> <input type="button" value="White/Black List Option"/> Log: <input type="button" value="Enable"/>                                                          |                                                                                                                                                                                                                                               |
| <input type="checkbox"/> Enable SYN flood defense                                                                                                                                                                                                                      | Threshold <input type="text" value="2000"/> packets / sec<br>Timeout <input type="text" value="10"/> sec                                                                                                                                      |
| <input type="checkbox"/> Enable UDP flood defense                                                                                                                                                                                                                      | Threshold <input type="text" value="5000"/> packets / sec<br>Timeout <input type="text" value="10"/> sec                                                                                                                                      |
| <input type="checkbox"/> Enable ICMP flood defense                                                                                                                                                                                                                     | Threshold <input type="text" value="250"/> packets / sec<br>Timeout <input type="text" value="10"/> sec                                                                                                                                       |
| <input type="checkbox"/> Enable Port Scan detection                                                                                                                                                                                                                    | Threshold <input type="text" value="2000"/> packets / sec                                                                                                                                                                                     |
| <input type="checkbox"/> Block IP options<br><input type="checkbox"/> Block Land<br><input type="checkbox"/> Block Smurf<br><input type="checkbox"/> Block trace route<br><input type="checkbox"/> Block SYN fragment<br><input type="checkbox"/> Block Fraggle Attack | <input type="checkbox"/> Block TCP flag scan<br><input type="checkbox"/> Block Tear Drop<br><input type="checkbox"/> Block Ping of Death<br><input type="checkbox"/> Block ICMP fragment<br><input type="checkbox"/> Block Unassigned Numbers |
| <input type="button" value="OK"/> <input type="button" value="Clear All"/> <input type="button" value="Cancel"/>                                                                                                                                                       |                                                                                                                                                                                                                                               |

**Note:**

- Enabling the UDP Flood Defense option may affect UDP services, like NAT-T VPN, DNS, and VoIP service. When you have UDP servers running, please increase the UDP threshold according to the Internet speed, or add the server IP into the White List. The suggested threshold value are as follows:  
 20M Bandwidth: 2,000 (packets/sec)  
 60M Bandwidth: 5,000 (packets/sec)  
 100M Bandwidth: 8,000 (packets/sec)  
 300M Bandwidth: 25,000 (packets/sec)
- Packets that have been accelerated by Hardware Acceleration will not be checked by the DoS Defense function.

Available settings are explained as follows:

| Item                     | Description                                                                                                                                                                                                                                                                      |
|--------------------------|----------------------------------------------------------------------------------------------------------------------------------------------------------------------------------------------------------------------------------------------------------------------------------|
| Enable Dos Defense       | Select to enable DoS Defense.<br>Select All - Click to select all DoS Defense options.<br>White/Black List Option - Set white/black list of IPv4/IPv6 address.                                                                                                                   |
| Enable SYN flood defense | Select to enable SYN flood defense. When the arrival rate of SYN packets exceeds the Threshold value, the router will start to randomly discard TCP SYN packets for a period of time as defined in Timeout. This is to prevent TCP SYN packets from exhausting router resources. |

|                            |                                                                                                                                                                                                                                                                                                                                                                                                                                                                                               |
|----------------------------|-----------------------------------------------------------------------------------------------------------------------------------------------------------------------------------------------------------------------------------------------------------------------------------------------------------------------------------------------------------------------------------------------------------------------------------------------------------------------------------------------|
|                            | The default values of threshold and timeout are 2000 packets per second and 10 seconds, respectively.                                                                                                                                                                                                                                                                                                                                                                                         |
| Enable UDP flood defense   | Select to enable UDP flood defense. When the arrival rate of UDP packets exceeds the Threshold value, the router will start to randomly discard TCP SYN packets for a period of time as defined in Timeout.<br>The default values of threshold and timeout are 2000 packets per second and 10 seconds, respectively.                                                                                                                                                                          |
| Enable ICMP flood defense  | Select to enable ICMP flood defense. When the arrival rate of ICMP packets exceeds the Threshold value, the router will start to randomly discard TCP SYN packets for a period of time as defined in Timeout.<br>The default values of threshold and timeout are 250 packets per second and 10 seconds, respectively.                                                                                                                                                                         |
| Enable Port Scan detection | Select to enable Port Scan detection. Port Scans attack your network by sending packets to a range of ports in an attempt to find services that would respond. When Port Scan detection is enabled, the router sends warning messages when it detects port scanning activities that exceed the Threshold rate.<br>The default threshold is 2000 packets per second.                                                                                                                           |
| Block IP options           | Select to enable Block IP options. The Vigor router will ignore IP packets with IP option field set in the datagram header. IP options are rarely used and could be abused by attackers as they carry information about the private network otherwise not available to the external network, such as security, TCC (closed user group) parameters, a series of Internet addresses, routing messages, etc, which external eavesdroppers can use to discover details about the private network. |
| Block Land                 | Select to Block LAND attacks. LAND attacks happen when an attacker sends spoofed SYN packets with both source and destination addresses set to that of the target system, which causes the target to reply to itself continuously.                                                                                                                                                                                                                                                            |
| Block Smurf                | Select to Block Smurf attacks. The router will ignore any broadcasting ICMP echo request.                                                                                                                                                                                                                                                                                                                                                                                                     |
| Block trace route          | Select to Block traceroutes. The router will not forward traceroute packets.                                                                                                                                                                                                                                                                                                                                                                                                                  |
| Block SYN fragment         | Select to Block SYN packet fragments. The router will drop any packets having both the SYN and more-fragments bits set.                                                                                                                                                                                                                                                                                                                                                                       |
| Block Fraggle Attack       | Select to Block Fraggle Attacks. Broadcast UDP packets received from the Internet are blocked.<br>Activating this feature might block some legitimate packets. Since all broadcast UDP packets coming from the Internet are blocked, RIP packets from the Internet could also be dropped.                                                                                                                                                                                                     |
| Block TCP flag scan        | Select to Block TCP Flag Scans. TCP packets with abnormal flag settings will be dropped. TCP flag scanning activities that are blocked include no flag scan, FIN without ACK scan, SYN FIN scan, Xmas scan and full Xmas scan.                                                                                                                                                                                                                                                                |
| Block Tear Drop            | Select to Block Tear Drop attacks. Some clients may crash when they receive ICMP datagrams (packets) that exceed                                                                                                                                                                                                                                                                                                                                                                              |

|                          |                                                                                                                                                                                                                                                                                                                                                                                                                                                                                                                                                                                                                                                                                                                                                                                                                                                                                                                                                                                                                                                                                                                                                                                                                                                                                                                                                                                                                                                                                                                                                                                                                                                                                                                                                                                                                                                                                                                                                                                                                                                                                                                                                                                                                                                                                                                                                                                                                                                                                                                                                                                                                                                                                                |
|--------------------------|------------------------------------------------------------------------------------------------------------------------------------------------------------------------------------------------------------------------------------------------------------------------------------------------------------------------------------------------------------------------------------------------------------------------------------------------------------------------------------------------------------------------------------------------------------------------------------------------------------------------------------------------------------------------------------------------------------------------------------------------------------------------------------------------------------------------------------------------------------------------------------------------------------------------------------------------------------------------------------------------------------------------------------------------------------------------------------------------------------------------------------------------------------------------------------------------------------------------------------------------------------------------------------------------------------------------------------------------------------------------------------------------------------------------------------------------------------------------------------------------------------------------------------------------------------------------------------------------------------------------------------------------------------------------------------------------------------------------------------------------------------------------------------------------------------------------------------------------------------------------------------------------------------------------------------------------------------------------------------------------------------------------------------------------------------------------------------------------------------------------------------------------------------------------------------------------------------------------------------------------------------------------------------------------------------------------------------------------------------------------------------------------------------------------------------------------------------------------------------------------------------------------------------------------------------------------------------------------------------------------------------------------------------------------------------------------|
|                          | the maximum length. The router discards any fragmented ICMP packets having lengths greater than 1024 octets.                                                                                                                                                                                                                                                                                                                                                                                                                                                                                                                                                                                                                                                                                                                                                                                                                                                                                                                                                                                                                                                                                                                                                                                                                                                                                                                                                                                                                                                                                                                                                                                                                                                                                                                                                                                                                                                                                                                                                                                                                                                                                                                                                                                                                                                                                                                                                                                                                                                                                                                                                                                   |
| Block Ping of Death      | Select to Block Ping of Death, where fragmented ping packets are sent to target hosts so that those hosts could crash as they reassemble the malformed ping packets.                                                                                                                                                                                                                                                                                                                                                                                                                                                                                                                                                                                                                                                                                                                                                                                                                                                                                                                                                                                                                                                                                                                                                                                                                                                                                                                                                                                                                                                                                                                                                                                                                                                                                                                                                                                                                                                                                                                                                                                                                                                                                                                                                                                                                                                                                                                                                                                                                                                                                                                           |
| Block ICMP Fragment      | Select to Block ICMP Fragments. ICMP packets with the more-fragments bit set are dropped.                                                                                                                                                                                                                                                                                                                                                                                                                                                                                                                                                                                                                                                                                                                                                                                                                                                                                                                                                                                                                                                                                                                                                                                                                                                                                                                                                                                                                                                                                                                                                                                                                                                                                                                                                                                                                                                                                                                                                                                                                                                                                                                                                                                                                                                                                                                                                                                                                                                                                                                                                                                                      |
| Block Unassigned Numbers | Select to Block Unassigned Protocol Numbers, and the router will block packets having unassigned protocol numbers. Individual IP packet has a protocol field in the datagram header to indicate the protocol type running over the upper layer. However, the protocol types greater than 100 are reserved and undefined at this time. Therefore, the router should have ability to detect and reject this kind of packets.                                                                                                                                                                                                                                                                                                                                                                                                                                                                                                                                                                                                                                                                                                                                                                                                                                                                                                                                                                                                                                                                                                                                                                                                                                                                                                                                                                                                                                                                                                                                                                                                                                                                                                                                                                                                                                                                                                                                                                                                                                                                                                                                                                                                                                                                     |
| Warning Messages         | <p>We provide Syslog function for user to retrieve message from Vigor router. The user, as a Syslog Server, shall receive the report sending from Vigor router which is a Syslog Client.</p> <p>All the warning messages related to DoS Defense will be sent to user and user can review it through Syslog daemon. Look for the keyword DoS in the message, followed by a name to indicate what kind of attacks is detected.</p> <p>System Maintenance &gt;&gt; SysLog / Mail Alert Setup</p> <p><b>SysLog / Mail Alert Setup</b></p> <p><b>SysLog Access Setup</b></p> <ul style="list-style-type: none"> <li><input checked="" type="checkbox"/> Enable</li> <li>Syslog Save to:       <ul style="list-style-type: none"> <li><input checked="" type="checkbox"/> Syslog Server</li> <li><input type="checkbox"/> USB Disk</li> </ul> </li> <li>Maximum Syslog folder space: 1 GB</li> <li>When Syslog folder is full: Overwrite oldest logs</li> <li>Router Name: DrayTek</li> <li>Server IP/Hostname: [ ]</li> <li>Destination Port: 514</li> <li>Mail Syslog: <input type="checkbox"/> Enable</li> <li>Enable syslog message:       <ul style="list-style-type: none"> <li><input checked="" type="checkbox"/> Firewall Log</li> <li><input checked="" type="checkbox"/> VPN Log</li> <li><input checked="" type="checkbox"/> User Access Log / Hotspot User Information</li> <li><input checked="" type="checkbox"/> WAN Log</li> <li><input checked="" type="checkbox"/> Router/DSL information</li> </ul> </li> </ul> <p><b>Mail Alert Setup</b></p> <ul style="list-style-type: none"> <li><input checked="" type="checkbox"/> Enable <input type="button" value="Send a test e-mail"/></li> <li>Interface: Any</li> <li>SMTP Server: [ ]</li> <li>SMTP Port: 25</li> <li>Mail To: [ ]</li> <li>Sender Address: [ ]</li> <li>Connection Security: Plaintext</li> <li><input type="checkbox"/> Authentication       <ul style="list-style-type: none"> <li>Username: [ ]</li> <li>Password: [ ]</li> </ul> </li> <li>Enable E-Mail Alert:       <ul style="list-style-type: none"> <li><input checked="" type="checkbox"/> DoS Attack</li> <li><input checked="" type="checkbox"/> APPE</li> <li><input checked="" type="checkbox"/> VPN LOG</li> <li><input type="checkbox"/> APPE Signature</li> <li><input type="checkbox"/> Debug Log</li> </ul> </li> </ul> <p><b>Note:</b></p> <ol style="list-style-type: none"> <li>1. USB Syslog space is available from 256-1024 MB or 1-16 GB.</li> <li>2. Mail Syslog cannot be activated unless USB Disk is ticked for "Syslog Save to".</li> <li>3. Mail Syslog feature will send the Syslog when it is full.</li> </ol> <p>OK Clear</p> |

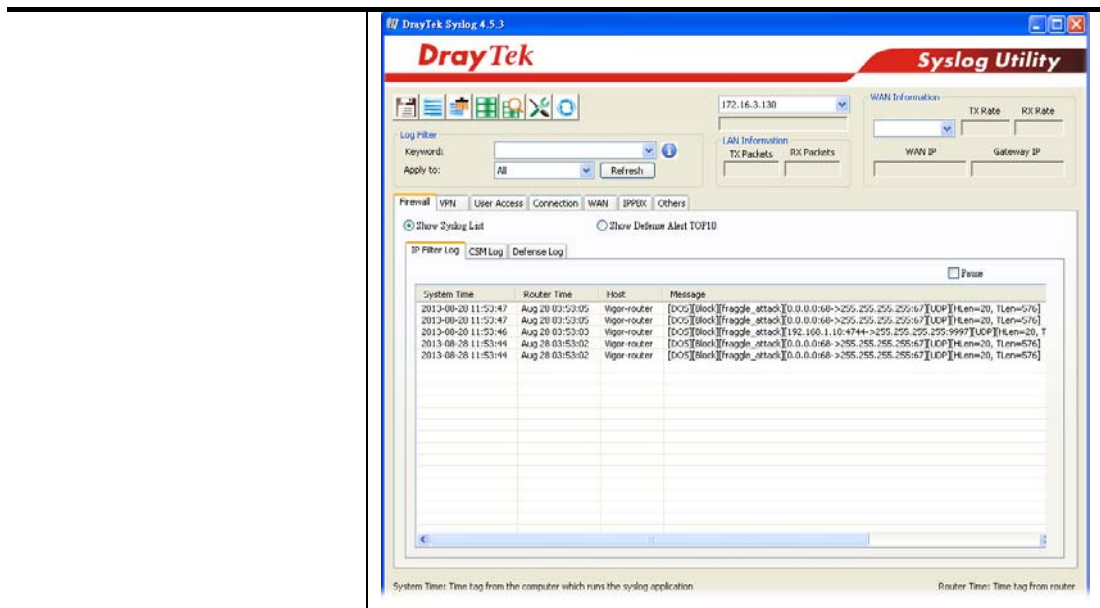

After finishing all the settings here, please click OK to save the configuration.

## VI-1-3-2 Spoofing Defense

Click the Spoofing Defense tab to open the setup page.

Firewall >> Defense Setup

| DoS Defense                                                                                                                                                                                                                                                                                                                                                                                               | Spoofing Defense |
|-----------------------------------------------------------------------------------------------------------------------------------------------------------------------------------------------------------------------------------------------------------------------------------------------------------------------------------------------------------------------------------------------------------|------------------|
| <p><b>ARP Spoofing Defense</b> <span style="float: right;">Log: <input type="text" value="Enable"/></span></p> <p><input checked="" type="checkbox"/> Block ARP replies with inconsistent source MAC addresses.</p> <p><input checked="" type="checkbox"/> Block ARP replies with inconsistent destination MAC addresses.</p> <p><input checked="" type="checkbox"/> Decline VRRP MAC into ARP table.</p> |                  |
| <p><b>IP Spoofing Defense</b></p> <p><input checked="" type="checkbox"/> Block IP packet from WAN with inconsistent source IP addresses.</p> <p><input type="checkbox"/> Block IP packet from LAN with inconsistent source IP addresses.</p> <p style="text-align: center;"> <input type="button" value="OK"/> <input type="button" value="Cancel"/> </p>                                                 |                  |

## VI-1-4 Diagnose

The purpose of this function is to test when the router receiving incoming packet, which firewall rule will be applied to that packet. The test result, including firewall rule profile, IP address translation in packet transmission, state of the firewall functions and etc., also will be shown on this page.



### Info

The result obtained by using Diagnose is offered for RD debug. It will be different according to actual state such as network connection, LAN/WAN settings and so on.

Firewall >> Diagnose

---

**Mode**  
 ICMP  UDP  TCP

**Direction**

**Test View**

A → LAN → B

Src IP

Src MAC

Dst IP

**Packet & Payload**

| Packet | Enable                              | Direction | Protocol       |
|--------|-------------------------------------|-----------|----------------|
| 1      | <input checked="" type="checkbox"/> | A->B      | ICMP:Customize |
| 2      | <input type="checkbox"/>            | A->B      | ICMP:Customize |

**Note:**  
 This is firewall live test which need setup WAN and plug cable in.

Available settings are explained as follows:

| Item      | Description                                                                                                                                                                                                                                                                                                             |
|-----------|-------------------------------------------------------------------------------------------------------------------------------------------------------------------------------------------------------------------------------------------------------------------------------------------------------------------------|
| Mode      | To have a firewall rule test, specify the service type (ICMP, UDP, TCP) of the packet and type of the IP address (IPv4/IPv6).                                                                                                                                                                                           |
| Direction | Set the way (from WAN or from LAN) that Vigor router receives the first packet for test. Different way means the firewall will process the connection initiated from LAN or from WAN.                                                                                                                                   |
| Test View | This is a dynamic display page.<br>According to the direction specified, test view will display the figure to guide you typing IP address, port number, and MAC address.<br>Later, after clicking the Analyze button, the information for the firewall rule profile and address translation will be shown on this page. |
| Src IP    | Enter the IPv4/IPv6 address of the packet's source.                                                                                                                                                                                                                                                                     |
| Src Port  | Enter the port number of the packet's source.                                                                                                                                                                                                                                                                           |
| Src MAC   | Enter the MAC address of the packet's source.                                                                                                                                                                                                                                                                           |
| Dst IP    | Enter the IPv4/IPv6 address of the packet's destination.                                                                                                                                                                                                                                                                |

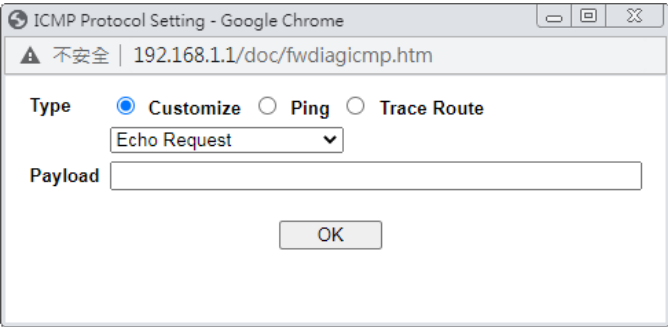
|                  |                                                                                                                                                                                                                                                                                                                                                                                                                                                                                                                                                                                                                                                                                                                                                                                                                                                                                                                                                                                                                                                                                                                                                                                                                                                                                                                  |
|------------------|------------------------------------------------------------------------------------------------------------------------------------------------------------------------------------------------------------------------------------------------------------------------------------------------------------------------------------------------------------------------------------------------------------------------------------------------------------------------------------------------------------------------------------------------------------------------------------------------------------------------------------------------------------------------------------------------------------------------------------------------------------------------------------------------------------------------------------------------------------------------------------------------------------------------------------------------------------------------------------------------------------------------------------------------------------------------------------------------------------------------------------------------------------------------------------------------------------------------------------------------------------------------------------------------------------------|
| Dst Port         | Enter the port number of the packet's destination.                                                                                                                                                                                                                                                                                                                                                                                                                                                                                                                                                                                                                                                                                                                                                                                                                                                                                                                                                                                                                                                                                                                                                                                                                                                               |
| Packet & Payload | <p>In firewall diagnose, two packets belong to one connection. In general, two packets are enough for Vigor router to perform this test.</p> <p>Enable - Check the box to send out the test packet.</p> <p>Direction - The first packet of the firewall test will follow the direction specified above. However, the direction for the second packet might be different. Simply choose the direction (from Computer A to B or from the B to A) for the second packet.</p> <p>Protocol - It displays the mode selected above and the state. If required, click the mode link to configure advanced setting. The common service type (Customize, Ping, Trace Route / Customize, DNS, Trace Route / Customize, Http(GET) related to that mode (ICMP / UDP / TCP) will be shown on the following dialog box.</p>  <ul style="list-style-type: none"> <li>● Type - Choose Customize, Ping, Trace Route / Customize, DNS, Trace Route / Customize, Http (GET).</li> <li>● Payload - It is available when Customize is selected. Simply type 16 HEX characters which represent certain packet (e.g., DNS packet) if you want to set the data transferred with protocol (ICMP/UDP/TCP) which is different to Type setting.</li> </ul> |
| Analyze          | Execute the test and analyze the result.                                                                                                                                                                                                                                                                                                                                                                                                                                                                                                                                                                                                                                                                                                                                                                                                                                                                                                                                                                                                                                                                                                                                                                                                                                                                         |

The following figure shows the test result after clicking Analyze. Processing state for the functions (MAC Filter, QoS, User management, etc.) related to the firewall will be displayed by green or red LED.

Firewall >> Diagnose

---

**Mode**  
 ICMP  UDP  TCP IPv4 ▾

**Direction**  
From LAN ▾

**Test View**

**A**

192.168.1.111:22222  
->7.7.7.51348

LAN

Firewall

WAN1

<<REPLY

7.7.7.51348  
172.16.2.234:62094<-

**B**

| Status | Packet | Set     | Rule    | UCF/WCF |
|--------|--------|---------|---------|---------|
| Pass   | 2      | default | default | n/a     |

**Packet & Payload**

| Packet                                       | Enable                                         | Direction                                  | Protocol                                     |                                             |                                            |                                         |
|----------------------------------------------|------------------------------------------------|--------------------------------------------|----------------------------------------------|---------------------------------------------|--------------------------------------------|-----------------------------------------|
| 1                                            | <input checked="" type="checkbox"/>            | A->B ▾                                     | UDP:Customize                                |                                             |                                            |                                         |
| Acceleration                                 |                                                |                                            |                                              |                                             |                                            |                                         |
| 2                                            | <input checked="" type="checkbox"/>            | B->A ▾                                     | UDP:Customize                                |                                             |                                            |                                         |
| Acceleration                                 |                                                |                                            |                                              |                                             |                                            |                                         |
| <input checked="" type="checkbox"/> SESS CTL | <input checked="" type="checkbox"/> MAC FILTER | <input checked="" type="checkbox"/> PCAP   | <input checked="" type="checkbox"/> USER MGT | <input checked="" type="checkbox"/> APPE    | <input checked="" type="checkbox"/> UCF    | <input checked="" type="checkbox"/> WCE |
| <input checked="" type="checkbox"/> DNSF     | <input checked="" type="checkbox"/> SESS LMT   | <input checked="" type="checkbox"/> BW LMT | <input checked="" type="checkbox"/> QOS      | <input checked="" type="checkbox"/> APP_QOS | <input checked="" type="checkbox"/> HW ACC |                                         |

APP: The APP need to check. ●: The APP is completed.  
 APP: The APP doesn't need to check. ●: The APP is processing.

**Note:**  
 PCAP is "ip pcap" in telnet command.

<<Back Reset

---

## VI-2 Central Security Management (CSM)

Content Security Management (CSM) allows the network administrator to restrict Internet traffic based on the content type, thus ensuring appropriate use of network resources and also reducing the likelihood of threats from malicious network content.

### APP Enforcement Filter

The APP Enforcement Filter can be used to prevent users from using undesirable or inappropriate network applications such as online chat and peer-to-peer programs. The filter works by detecting and blocking network traffic of applications by means of traffic patterns.

### URL Content Filter

The URL Content Filter scans URL strings in HTTP requests for predefined keywords to restrict browsing activities.

### Web Content Filter

Users can also be prevented from browsing certain types of websites by using the Web Content Filter. This filter classifies website domain names into different categories, which can be selectively blocked.

Filter profiles must first be created before these CSM Filters can be enabled. Once profiles have been configured, they can be applied to the Default Rule under Firewall>>General Setup, or Filter Rules in Filter Sets under Firewall>>Filter Setup.



---

Info

---

The priority of URL Content Filter is higher than Web Content Filter.

---



---

## Web User Interface

Objects Setting  
CSM  
APP Enforcement Profile  
APPE Signature Upgrade  
URL Content Filter Profile  
Web Content Filter Profile  
DNS Filter Profile

---

### VI-2-1 APP Enforcement Profile

Up to 32 policy profiles for APP Enforcement can be configured.

CSM >> APP Enforcement Profile

APP Enforcement Profile Table:

[Set to Factory Default](#)

| Profile             | Name | Profile             | Name |
|---------------------|------|---------------------|------|
| <a href="#">1.</a>  |      | <a href="#">17.</a> |      |
| <a href="#">2.</a>  |      | <a href="#">18.</a> |      |
| <a href="#">3.</a>  |      | <a href="#">19.</a> |      |
| <a href="#">4.</a>  |      | <a href="#">20.</a> |      |
| <a href="#">5.</a>  |      | <a href="#">21.</a> |      |
| <a href="#">6.</a>  |      | <a href="#">22.</a> |      |
| <a href="#">7.</a>  |      | <a href="#">23.</a> |      |
| <a href="#">8.</a>  |      | <a href="#">24.</a> |      |
| <a href="#">9.</a>  |      | <a href="#">25.</a> |      |
| <a href="#">10.</a> |      | <a href="#">26.</a> |      |
| <a href="#">11.</a> |      | <a href="#">27.</a> |      |
| <a href="#">12.</a> |      | <a href="#">28.</a> |      |
| <a href="#">13.</a> |      | <a href="#">29.</a> |      |
| <a href="#">14.</a> |      | <a href="#">30.</a> |      |
| <a href="#">15.</a> |      | <a href="#">31.</a> |      |
| <a href="#">16.</a> |      | <a href="#">32.</a> |      |

Available settings are explained as follows:

| Item                   | Description                                                                       |
|------------------------|-----------------------------------------------------------------------------------|
| Set to Factory Default | Clear all profile settings.                                                       |
| Profile                | Index of the profile.<br>Click to bring up the configuration page of the profile. |
| Name                   | Name of the profile.                                                              |

To configure a profile, click on its profile number, and the following profile configuration page will appear:

CSM >> APP Enforcement Profile

Profile Index : 1

Profile Name:

| For Firewall                              | For Route Policy                            |                                             |                                        |
|-------------------------------------------|---------------------------------------------|---------------------------------------------|----------------------------------------|
| <b>Category</b>                           | <b>Application</b>                          |                                             |                                        |
| <b>Instant Message</b>                    | <input type="checkbox"/> AIM Login          | <input type="checkbox"/> AliWW              | <input type="checkbox"/> Ares          |
|                                           | <input type="checkbox"/> BaiduHi            | <input type="checkbox"/> Facebook/Instagram | <input type="checkbox"/> Fetion        |
| <input type="button" value="Select All"/> | <input type="checkbox"/> GaduGadu Protocol  | <input type="checkbox"/> ICQ                | <input type="checkbox"/> iSpQ          |
|                                           | <input type="checkbox"/> KC                 | <input type="checkbox"/> LINE               | <input type="checkbox"/> LinkedIn      |
| <input type="button" value="Clear All"/>  | <input type="checkbox"/> Paltalk            | <input type="checkbox"/> PocoCall           | <input type="checkbox"/> Qnext         |
|                                           | <input type="checkbox"/> Signal             | <input type="checkbox"/> Slack              | <input type="checkbox"/> Snapchat      |
|                                           | <input type="checkbox"/> Telegram           | <input type="checkbox"/> Tencent QQ         | <input type="checkbox"/> UC            |
|                                           | <input type="checkbox"/> WebIM URLs         | <input type="checkbox"/> WhatsApp           | <input type="checkbox"/> WhatsApp Call |
|                                           | <input type="checkbox"/> Zalo               |                                             |                                        |
| <b>VoIP</b>                               | <input type="checkbox"/> RC Voice           | <input type="checkbox"/> Skype/Teams        | <input type="checkbox"/> TeamSpeak     |
| <input type="button" value="Select All"/> | <input type="checkbox"/> TelTel             | <input type="checkbox"/> WeChat             |                                        |
| <input type="button" value="Clear All"/>  |                                             |                                             |                                        |
| <b>P2P</b>                                | <input type="checkbox"/> Ares               | <input type="checkbox"/> BitTorrent         | <input type="checkbox"/> ClubBox       |
| <input type="button" value="Select All"/> | <input type="checkbox"/> eDonkey            | <input type="checkbox"/> FastTrack          | <input type="checkbox"/> Gnutella      |
|                                           | <input type="checkbox"/> Huntmine           | <input type="checkbox"/> Kuwo               | <input type="checkbox"/> OpenFT        |
| <input type="button" value="Clear All"/>  | <input type="checkbox"/> OpenNap            | <input type="checkbox"/> Pando              | <input type="checkbox"/> SoulSeek      |
|                                           | <input type="checkbox"/> Vagaa              | <input type="checkbox"/> Xunlei(Thunder)    |                                        |
| <b>Protocol</b>                           | <input type="checkbox"/> BGP                | <input type="checkbox"/> DNS                | <input type="checkbox"/> FTP           |
|                                           | <input type="checkbox"/> GIT                | <input type="checkbox"/> H.323              | <input type="checkbox"/> HTTP          |
|                                           | <input type="checkbox"/> IBM Informix       | <input type="checkbox"/> IBM DB2            | <input type="checkbox"/> ICMP          |
| <input type="button" value="Select All"/> | <input type="checkbox"/> IMAP/IMAP STARTTLS | <input type="checkbox"/> IRC                | <input type="checkbox"/> Microsoft SQL |
|                                           | <input type="checkbox"/> MQTT               | <input type="checkbox"/> MySQL              | <input type="checkbox"/> NNTP          |
|                                           | <input type="checkbox"/> NNTPS              | <input type="checkbox"/> NTP                | <input type="checkbox"/> Oracle        |

Available settings are explained as follows:

| Item                     | Description                                                                                     |
|--------------------------|-------------------------------------------------------------------------------------------------|
| Profile Name             | Name that identifies this profile. Maximum length is 15 characters.                             |
| Category                 | Apps are classified into several categories. Each category contains several apps to be blocked. |
| Clone Profile            | Click it to clone settings configured by an existed profile.                                    |
| Select All               | Click to select all of the items on this page.                                                  |
| Clear All                | Click to deselect all selected items.                                                           |
| <input type="checkbox"/> | Select this checkbox to block the app.                                                          |

To save changes on the page, click OK. To discard changes, click Cancel.

## VI-2-2 APPE Signature Upgrade

The APP Enforcement Profile feature identifies applications by matching their network traffic to signatures. DrayTek periodically releases APPE signature upgrades to ensure that new applications or new versions can be detected.

Upgrade checks can be performed manually or automatically.

CSM >> APPE Signature Upgrade

**APP Enforcement License** [Activate](#)  
 [Status: **Inactivated**]

**Upgrade Setting**  
 APPE Module Version: 15.29 [APPE Support List](#)  
 Upgrade via interface: auto-selected ▼ (Waiting for WAN connection...)

**Setup Download Server** auto-selected [Find more](#)

Signature authentication / download message  
 [2000-01-01 00:00:00] Load APPE signature failed. System will use APPE default signature.

**Upgrade Manually** Import

**Upgrade Automatically**

Scheduled Update

Every: 1 ▼ (hour) 00 ▼ (minutes after the hour)

Daily: 0 ▼ (hour) 00 ▼ (minute)

Weekly: Sunday ▼ (day) 0 ▼ (hour) 00 ▼ (minute)

OK

Available settings are explained as follows:

| Item                    | Description                                                                                                                                                                                                                                                                                                                                                                                                                                                                                                             |
|-------------------------|-------------------------------------------------------------------------------------------------------------------------------------------------------------------------------------------------------------------------------------------------------------------------------------------------------------------------------------------------------------------------------------------------------------------------------------------------------------------------------------------------------------------------|
| APP Enforcement License | Status - Display current license status.                                                                                                                                                                                                                                                                                                                                                                                                                                                                                |
| Upgrade Setting         | <p>APPE Module Version - Shows the current version of the APPE signature.</p> <p>New version from the Internet - The Download button is enabled only when there is a newer version of APPE signature than the one present on the router. After clicking on the Download button, a dialog box will appear, displaying the release information of the new version. Click OK in the dialog box to proceed with the download.</p> <p>Upgrade via interface - Select a WAN interface to download the new APPE signature.</p> |
| Setup Download Server   | <p>Specify a download server by typing its URL of the server. Click the <a href="#">Find more</a> for a list of download servers. When the default value auto-selected is used, the server is determined automatically by looking up the geolocation of the WAN IP address.</p> <p>Signature authentication/download message -Displays download status messages.</p>                                                                                                                                                    |

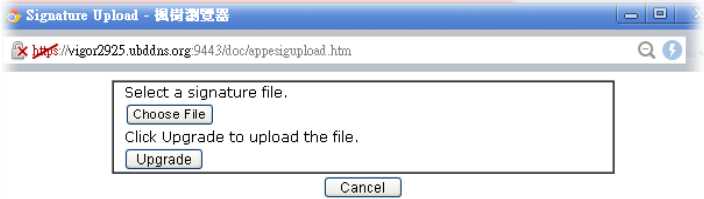
|                                     |                                                                                                                                                                                                                                                                                                                                                                                    |
|-------------------------------------|------------------------------------------------------------------------------------------------------------------------------------------------------------------------------------------------------------------------------------------------------------------------------------------------------------------------------------------------------------------------------------|
| <p><b>Upgrade Manually</b></p>      | <p>Use this functionality if you wish to upgrade using a previously-downloaded signature file.</p> <p><b>Import</b> - Clicking the button brings up the following page.</p>  <p>Click <b>Choose File</b> to select the signature file. Click <b>Upgrade</b> to initiate the upgrade process.</p> |
| <p><b>Upgrade Automatically</b></p> | <p><b>Scheduled Update</b> - Select to enable automatic periodic checking for signature updates.</p>                                                                                                                                                                                                                                                                               |

Click OK to save changes on the page.

## VI-2-3 URL Content Filter Profile

To set up URL Content Filter Profiles, click CSM on the Main Menu bar, and then click URL Content Filter Profile to open the profile setting page.

CSM >> URL Content Filter Profile



URL Content Filter Profile Table:

| [Set to Factory Default](#) |

| Profile   | Name | Profile   | Name |
|-----------|------|-----------|------|
| <u>1.</u> |      | <u>5.</u> |      |
| <u>2.</u> |      | <u>6.</u> |      |
| <u>3.</u> |      | <u>7.</u> |      |
| <u>4.</u> |      | <u>8.</u> |      |

**Note:**

To make URL Content Filter profile effective, please go to [Firewall >> Filter Setup](#) page to create a firewall rule and select the desired profile.

**Administration Message** (Max 255 characters)

[Default Message](#)

```
<body><center><br><p>The requested Web page has been blocked by URL Content Filter.<p>Please contact your system administrator for further information.</center></body>
```

OK

Each item is explained as follows:

| Item                   | Description                                                                                                                                                                                                                                    |
|------------------------|------------------------------------------------------------------------------------------------------------------------------------------------------------------------------------------------------------------------------------------------|
| Set to Factory Default | Clear all profile settings.                                                                                                                                                                                                                    |
| Profile                | Index number of the profile.                                                                                                                                                                                                                   |
| Name                   | Name that identifies the profile.                                                                                                                                                                                                              |
| Administration Message | The message to be displayed in the browser when access to a URL has been blocked. A custom message can be entered with HTML formatting in the text box.<br>Default Message - Click to reset the administration message to the factory default. |

To set up a profile, click the profile number under Index column to bring up the configuration page.

CSM >> URL Content Filter Profile

Profile Index: 1

Profile Name:

Priority:  Log:

**URL Access Control**

Enable URL Access Control       Prevent web access from IP address

Action:       Group/Object Selections

Exception List

**Web Feature**

Enable Web Feature Restriction

Action:       **File Extension Profile:**        Cookie       Proxy       Upload

Available settings are explained as follows:

| Item               | Description                                                                                                                                                                                                                                                                                                                                                                                                                                                                                                                                                                                                                                                                                                                                                                                                                                                                                                                                                                                                                                                                                      |
|--------------------|--------------------------------------------------------------------------------------------------------------------------------------------------------------------------------------------------------------------------------------------------------------------------------------------------------------------------------------------------------------------------------------------------------------------------------------------------------------------------------------------------------------------------------------------------------------------------------------------------------------------------------------------------------------------------------------------------------------------------------------------------------------------------------------------------------------------------------------------------------------------------------------------------------------------------------------------------------------------------------------------------------------------------------------------------------------------------------------------------|
| Profile Name       | Name that identifies the URL Content Filter profile. The maximum length of the Profile Name is 15 characters.                                                                                                                                                                                                                                                                                                                                                                                                                                                                                                                                                                                                                                                                                                                                                                                                                                                                                                                                                                                    |
| Priority           | <p>The order of evaluation of URL Access Control and Web Feature below:</p> <p><b>Both: Pass</b> - Router will allow access only to web resources that match conditions specified in both URL Access Control and Web Feature. The Action setting of both URL Access Control and Web Feature will be disabled and the values set to Pass.</p> <p><b>Both:Block</b> - Router will block access to web resources that match conditions specified in both URL Access Control and Web Feature. The Action setting of both URL Access Control and Web Feature will be disabled and the values set to Block.</p> <p><b>Either: URL Access Control First</b> - Router will block or allow access to web resources that match conditions specified in either URL Access Control or Web Feature. URL Access Control is applied first, followed by Web Feature.</p> <p><b>Either: Web Feature First</b> - Router will block or allow access to web resources that match conditions specified in either URL Access Control or Web Feature. Web Feature is applied first, followed by URL Access Control.</p> |
| Log                | <p><b>None</b> - No log file will be created for this profile.</p> <p><b>Pass</b> - Only passed access attempts will be recorded in Syslog.</p> <p><b>Block</b> - Only blocked access attempts will be recorded in Syslog.</p> <p><b>All</b> - Both passed and blocked access attempts will be recorded in Syslog.</p>                                                                                                                                                                                                                                                                                                                                                                                                                                                                                                                                                                                                                                                                                                                                                                           |
| URL Access Control | Enable URL Access Control - Select to activate URL Access                                                                                                                                                                                                                                                                                                                                                                                                                                                                                                                                                                                                                                                                                                                                                                                                                                                                                                                                                                                                                                        |

**Control.**

Prevent web access from IP address - URLs containing IP addresses (e.g., 192.168.1.1) will be blocked. Only URLs with domain addresses (e.g., www.draytek.com) will be allowed. This is to prevent users from circumventing URL Access Control.

Action - This setting is enabled only when Priority is set to Either: URL Access Control First or Either: Web Feature First.

- Pass - Allows access to web pages with URLs containing keywords that are in the selected keyword groups or objects. Access to other URLs is blocked.
- Block - Blocks access to web pages with URLs containing keywords that are in the selected keyword groups or objects. Access to other URLs is allowed.

Exception List - Specify the object profile(s) as the exception list which will be processed in an opposite manner to the action selected above.

Group/Object Selections - Shows the Keyword Groups and/or Objects selected for this URL Content Filter Profile.

To add or remove Keyword Groups and Objects to the selection, click the Edit button to bring up the following screen.

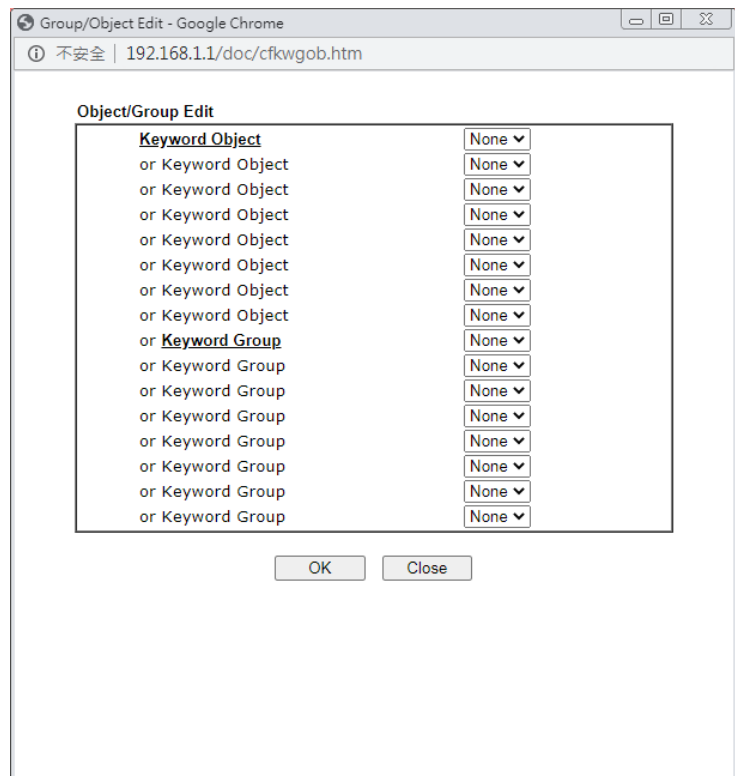

Up to 8 Keyword Objects and 8 Keyword Groups can be selected. To add, remove or modify Groups or Objects, click the Keyword Object or Keyword Group hyperlinks to bring up the Objects Setting >> Keyword Object or Objects Setting >> Keyword Group pages.

**Web Feature**

Enable Restrict Web Feature - Check to enable the web feature restriction.

Action - This setting is enabled only when Priority is set to Either: URL Access Control First or Either: Web Feature

---

|  |                                                                                                                                                                                                                                                                                                                                                                                                                                                                                                                                                                                                                                                                                                                                                                                                    |
|--|----------------------------------------------------------------------------------------------------------------------------------------------------------------------------------------------------------------------------------------------------------------------------------------------------------------------------------------------------------------------------------------------------------------------------------------------------------------------------------------------------------------------------------------------------------------------------------------------------------------------------------------------------------------------------------------------------------------------------------------------------------------------------------------------------|
|  | <p>First.</p> <ul style="list-style-type: none"><li>● Pass - Allows access to web pages with URLs containing keywords that are in the selected keyword groups or objects. Access to other URLs is blocked.</li><li>● Block - Blocks access to web pages with URLs containing keywords that are in the selected keyword groups or objects. Access to other URLs is allowed.</li></ul> <p>File Extension Profile - Choose one of the profiles that you configured in Object Setting&gt;&gt; File Extension Objects previously for passing or blocking the file downloading.</p> <p>Cookie - Select to block cookies from Internet websites.</p> <p>Proxy - Select to block web proxy servers that relay HTTP traffic.</p> <p>Upload - Select to block HTTP uploads from the LAN to the Internet.</p> |
|--|----------------------------------------------------------------------------------------------------------------------------------------------------------------------------------------------------------------------------------------------------------------------------------------------------------------------------------------------------------------------------------------------------------------------------------------------------------------------------------------------------------------------------------------------------------------------------------------------------------------------------------------------------------------------------------------------------------------------------------------------------------------------------------------------------|

---

To save changes on the page, click OK. To discard changes, click Cancel. To clear all settings, click Clear.



## VI-2-4 Web Content Filter Profile

Trial WCF service can be activated using the Service Activation Wizard.

If you wish to continue using WCF beyond the trial period, you can obtain a full WCF subscription by contacting your local DrayTek channel partner or dealer. WCF subscriptions can be activated using the Activate link on CSM >> Web Content Filter Profile (described in this section) or System Maintenance.

From the main menu, click CSM, followed by Web Content Filter Profile to load the profile configuration page.



### Info 1

Web Content Filter (WCF) is not a built-in service of Vigor router but a service powered by Commtouch. If you want to use such service (trial or formal edition), you have to perform the procedure of activation first. For the service of formal edition, please contact with your dealer/distributor for detailed information.

### Info 2

Commtouch is merged by Cyren, and GlobalView services will be continued to deliver powerful cloud-based information security solutions! Refer to: <http://www.prnewswire.com/news-releases/commtouch-is-now-cyren-239025151.html>

CSM >> Web Content Filter Profile



Web-Filter License

[Activate](#)

[Status: **Inactivated**]

|                    |                                            |                           |
|--------------------|--------------------------------------------|---------------------------|
| Setup Query Server | <input type="text" value="auto-selected"/> | <a href="#">Find more</a> |
| Setup Test Server  | <input type="text" value="auto-selected"/> | <a href="#">Find more</a> |

Web Content Filter Profile Table:

Cache :  | [Set to Factory Default](#) |

| Profile | Name    | Profile | Name |
|---------|---------|---------|------|
| 1.      | Default | 5.      |      |
| 2.      |         | 6.      |      |
| 3.      |         | 7.      |      |
| 4.      |         | 8.      |      |

**Note:**

To make Web Content Filter profile effective, please go to [Firewall >> Filter Setup](#) page to create a firewall rule and select the desired profile.

Administration Message (Max 255 characters)

[Default Message](#)

```
<body><center><br><br><br><p>The requested Web page <br> from %SIP% <br>to %URL% <br>that is categorized with %CL% <br>has been blocked by %RNAME% Web Content Filter.<p>Please contact your system administrator for further information.</center></body>
```

**Legend:**

%SIP% - Source IP , %DIP% - Destination IP , %URL% - URL  
%CL% - Category , %RNAME% - Router Name

OK

Available settings are explained as follows:

| Item | Description |
|------|-------------|
|------|-------------|

|                        |                                                                                                                                                                                                                                                                                                                                                                                                                                                                                                                                                                                                                                                                                                                                                                                     |
|------------------------|-------------------------------------------------------------------------------------------------------------------------------------------------------------------------------------------------------------------------------------------------------------------------------------------------------------------------------------------------------------------------------------------------------------------------------------------------------------------------------------------------------------------------------------------------------------------------------------------------------------------------------------------------------------------------------------------------------------------------------------------------------------------------------------|
| Activate               | Click to visit the MyVigor website to activate WCF service. You will need to log in to your MyVigor account to proceed with the activation process. If you do not already have a MyVigor account, you can create one at this time.                                                                                                                                                                                                                                                                                                                                                                                                                                                                                                                                                  |
| Setup Query Server     | Specify a WCF query server by typing address of the server. Click the <a href="#">Find more</a> for a list of query servers. When the default value auto-selected is used, the server is determined automatically by looking up the geolocation of the WAN IP address.<br>It is recommended that the default setting auto-selected be used.                                                                                                                                                                                                                                                                                                                                                                                                                                         |
| Setup Test Server      | Specify a WCF test server by typing address of the server. Click the <a href="#">Find more</a> for a list of test servers. When the default value auto-selected is used, the server is determined automatically by looking up the geolocation of the WAN IP address.<br>It is recommended that the default setting auto-selected be used.                                                                                                                                                                                                                                                                                                                                                                                                                                           |
| Cache                  | None - The router verifies every HTTP URL requested by communicating with the WCF server on the Internet. This mode provides the most precise URL matching but has the lowest performance.<br>L1 - The router caches the HTTP URLs that have been checked against the WCF server. URLs will be looked up in the L1 cache before reaching out to the WCF server. When the cache is full, the oldest entry will be deleted to accommodate new URLs.<br>L2 - After a URL has been checked and found to pass WCF, the source and destination IPs are cached for about 1 second in the L2 cache. This is to allow a webpage to be loaded without further verifying the same URLs against the L1 cache or the WCF server.<br>L1+L2 Cache - The router will utilize both L1 and L2 caches. |
| Set to Factory Default | Clear all profile settings.                                                                                                                                                                                                                                                                                                                                                                                                                                                                                                                                                                                                                                                                                                                                                         |
| Profile                | Index number of the profile.                                                                                                                                                                                                                                                                                                                                                                                                                                                                                                                                                                                                                                                                                                                                                        |
| Name                   | Name that identifies the profile.                                                                                                                                                                                                                                                                                                                                                                                                                                                                                                                                                                                                                                                                                                                                                   |
| Administration Message | The message to be displayed in the browser when access to a website has been blocked. A custom message can be entered with HTML formatting in the text box.<br>You can embed the following variables in the message:<br>%SIP% - The source IP address that attempted the HTTP access.<br>%DIP% - The destination IP address to which access was attempted.<br>%URL% - The URL of the destination website.<br>%CL% - The category to which the URL belongs.<br>%RNAME% - The name of the router.<br>Default Message - Click to reset the administration message to the factory default.                                                                                                                                                                                              |

Up to 8 WCF profiles can be set up. To configure a profile, click its profile number to bring up its configuration page. Filter profile settings are specific to WCF providers. If you already

have an active WCF subscription, activating a WCF subscription to a provider different from your current provider will clear all existing profile configurations.

CSM >> Web Content Filter Profile

---

Profile Index: 1  
 Profile Name:  Log:

**Black/White List**

Enable  
 Action:  URL keywords:

Action:

**Security**

**Basic Categories**

Anonymizers       Botnets       Compromised  
 Malware       Network Errors       Parked Domains  
 Phishing & Fraud       Spam Sites

**Advanced Categories**

Cryptocurrency Mining       Suspected Malware       Suspected Phishing

**Parental Control**

**Basic Categories**

Alcohol & Tobacco       Chat       Child Abuse Images  
 Criminal Activity       Cults       Hate & Intolerance  
 Illegal Drugs       Nudity       Pornography/Sexually Explicit  
 School Cheating       Sex Education       Tasteless  
 Violence       Weapons

**Advanced Categories**

Available settings are explained as follows:

| Item                  | Description                                                                                                                                                                                                                                                                                                                                                                                                                                                                                                     |
|-----------------------|-----------------------------------------------------------------------------------------------------------------------------------------------------------------------------------------------------------------------------------------------------------------------------------------------------------------------------------------------------------------------------------------------------------------------------------------------------------------------------------------------------------------|
| Profile Name          | Name that identifies the WCF profile. The maximum length of the Profile Name is 15 characters.                                                                                                                                                                                                                                                                                                                                                                                                                  |
| Log                   | <p>Pass - Only passed access attempts will be recorded in Syslog.</p> <p>Block - Only blocked access attempts will be recorded in Syslog.</p> <p>All - Both passed and blocked access attempts will be recorded in Syslog.</p>                                                                                                                                                                                                                                                                                  |
| Black/White List      | <p>Keyword objects and groups can be applied to the URL to override WCF category filtering.</p> <p>Enable - Select to enable blacklisting or whitelisting.</p> <p>Action - Action to take when a URL matches keyword group and object selections.</p> <ul style="list-style-type: none"> <li>● Pass - Allow access to the URL.</li> <li>● Block - Disallow access to the URL.</li> </ul> <p>URL Keywords - Displays selected keyword group and objects. Click the Edit button to modify keyword selections.</p> |
| Groups and Categories | <p>Select categories to be included in the filter.</p> <p>Action - Action to take when a URL matches keyword group and object selections.</p> <ul style="list-style-type: none"> <li>● Pass - allow access to the URL.</li> <li>● Block - disallow access to the URL.</li> </ul> <p>Select All - Click to select all categories within the group.</p>                                                                                                                                                           |

---

|                                                                |
|----------------------------------------------------------------|
| Clear All - Click to deselect all categories within the group. |
|----------------------------------------------------------------|

---

To save changes on the page, click OK. To discard changes, click Cancel.

## VI-2-5 DNS Filter Profile

DNS Filter blocks or allows traffic to the WAN by intercepting DNS queries, and applying UCF and WCF rules to hostnames. DNS filtering is especially useful when you wish to restrict access of protocols other than HTTP, such as HTTPS. Note that a WCF license must have already been activated before WCF rules could be used.

To configure DNS Filter Profiles, select CSM >> Web Content Filter Profile from the main menu.

CSM >> DNS Filter

---

**DNS Filter Profile Table** [Set to Factory Default!](#)

| Profile | Name | Profile | Name |
|---------|------|---------|------|
| 1.      |      | 5.      |      |
| 2.      |      | 6.      |      |
| 3.      |      | 7.      |      |
| 4.      |      | 8.      |      |

**Note:**  
To make DNS Filter profile effective, please go to [Firewall >> Filter Setup](#) page to create a firewall rule and select the desired profile.

**DNS Filter Local Setting**

**DNS Filter**  Enable

**Web Content Filter** None ▾

**URL Content Filter** None ▾

**Syslog** None ▾

**Black/White List**  Enable Blacklist ▾

**Address Type** Any Address ▾

**Start IP Address** 0.0.0.0

**End IP Address** 0.0.0.0

**Subnet Mask** 0.0.0.0

**IP Group** None ▾

or IP Group None ▾

or **IP Object** None ▾

or IP Object None ▾

**Administration Message** (Max 255 characters) Default Message

<body><center><br><br><br><p>The requested Web page <br> from %SIP% <br>to %URL% <br>that is categorized with %CL% <br>has been blocked by %RNAME% DNS Filter.<p>Please contact your system administrator for further information.</center></body>

**Legend:**  
 %SIP% - Source IP , %URL% - URL  
 %CL% - Category , %RNAME% - Router Name

OK
Cancel

Available settings are explained as follows:

| Item                     | Description                                                                                                                                                                                                                                                                                          |
|--------------------------|------------------------------------------------------------------------------------------------------------------------------------------------------------------------------------------------------------------------------------------------------------------------------------------------------|
| DNS Filter Profile Table | DNS Filter Profiles take effect when DNS servers on the WAN are used for DNS queries. The router intercepts all outgoing DNS queries on UDP port 53 and applies WCF and UCF rules on the domain names before passing the queries to the DNS servers. IP addresses of the domains are then blocked or |

|                          |                                                                                                                                                                                                                                                                                                                                                                                                                                                                                                                                                                                                                                                                                                                                                                                                                                                                                                                                                                                                                                                                                                                                                                                      |
|--------------------------|--------------------------------------------------------------------------------------------------------------------------------------------------------------------------------------------------------------------------------------------------------------------------------------------------------------------------------------------------------------------------------------------------------------------------------------------------------------------------------------------------------------------------------------------------------------------------------------------------------------------------------------------------------------------------------------------------------------------------------------------------------------------------------------------------------------------------------------------------------------------------------------------------------------------------------------------------------------------------------------------------------------------------------------------------------------------------------------------------------------------------------------------------------------------------------------|
|                          | <p>allowed as per applicable WCF and UCF rules.</p> <p>DNS Filter Profiles can be applied by selecting from Firewall filter rules.</p> <p>Profile - Index number of the profile. Click to bring up the configuration page for the profile entry.</p> <p>Name - Name that identifies the profile.</p>                                                                                                                                                                                                                                                                                                                                                                                                                                                                                                                                                                                                                                                                                                                                                                                                                                                                                 |
| Set to Factory Default   | Clear all DNS Filter profile settings.                                                                                                                                                                                                                                                                                                                                                                                                                                                                                                                                                                                                                                                                                                                                                                                                                                                                                                                                                                                                                                                                                                                                               |
| DNS Filter Local Setting | <p>By setting the IP address of the DNS lookup server to the router's address, the router serves as a DNS lookup proxy server. When DNS Filter Local Setting is enabled, all DNS queries sent to the router will have WCF and UCF rules applied to the hostnames, and access to the resolved IP addresses will be allowed or blocked as configured in the rules.</p> <p>DNS Filter - Select to enable DNS Filter Local Setting.</p> <p>Web Content Filter - Select a WCF profile.</p> <p>URL Content Filter - Select a UCF profile.</p> <p>Syslog - The filtering result can be recorded according to the setting selected for Syslog.</p> <ul style="list-style-type: none"> <li>● None - No log file will be created for this profile.</li> <li>● Pass Only - Only passed access attempts will be recorded in Syslog.</li> <li>● Block Only- Only blocked access attempts will be recorded in Syslog.</li> <li>● Both - Both passed and blocked access attempts will be recorded in Syslog.</li> </ul> <p>Black/White List - Specify IP address, subnet mask, IP object, or IP group as a black list or white list for DNS packets passing through or blocked by Vigor router.</p> |
| Administration Message   | <p>The message to be displayed in the browser when access to a website has been blocked. A custom message can be entered with HTML formatting in the text box.</p> <p>You can embed the following variables in the message:</p> <ul style="list-style-type: none"> <li>● %SIP% - The source IP address that attempted the HTTP access.</li> <li>● %DIP% - The destination IP address to which access was attempted.</li> <li>● %URL% - The URL of the destination website.</li> <li>● %CL% - The category to which the URL belongs.</li> <li>● %RNAME% - The name of the router.</li> </ul> <p>Default Message - Click to reset the administration message to the factory default.</p>                                                                                                                                                                                                                                                                                                                                                                                                                                                                                               |

To save changes on the page, click OK. To discard changes, click Cancel.

# Application Notes

## A-1 How to Create an Account for MyVigor

The website of MyVigor (a server located on <http://myvigor.draytek.com>) provides several useful services (such as Anti-Spam, Web Content Filter, Anti-Intrusion, and etc.) to filtering the web pages for the sake of protecting your system.

To access into MyVigor for getting more information, please create an account for MyVigor.

### Create an Account via Vigor Router

1. Click CSM>> Web Content Filter Profile. The following page will appear.

CSM >> **Web Content Filter Profile** ?

---

**Web-Filter License**  
[Status: **Not Activated**] **Activate**

|                           |               |                           |
|---------------------------|---------------|---------------------------|
| <b>Setup Query Server</b> | auto-selected | <a href="#">Find more</a> |
| <b>Setup Test Server</b>  | auto-selected | <a href="#">Find more</a> |

**Web Content Filter Profile Table:** [Set to Factory Default](#)

| Profile   | Name    | Profile   | Name |
|-----------|---------|-----------|------|
| <u>1.</u> | Default | <u>5.</u> |      |
| <u>2.</u> |         | <u>6.</u> |      |
| <u>3.</u> |         | <u>7.</u> |      |
| <u>4.</u> |         | <u>8.</u> |      |

Administration Message (Max 255) Preview! Cache :

2. Click the Activate link. A login page for MyVigor web site will pop up automatically.

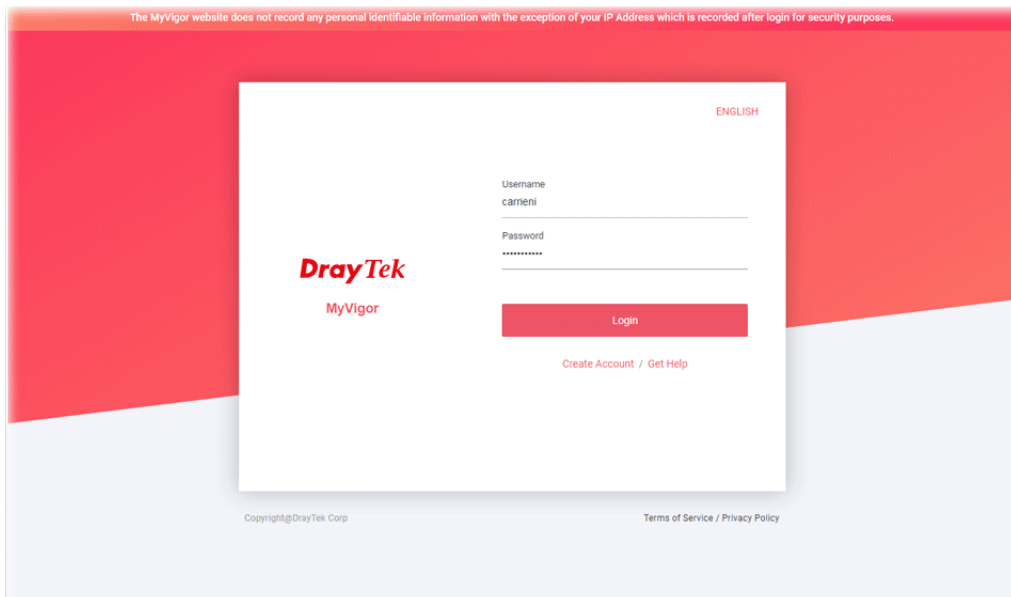

3. Click the link of Create Account.
4. The system will ask if you are 16 years old or over.
  - If yes, click I am 16 or over.

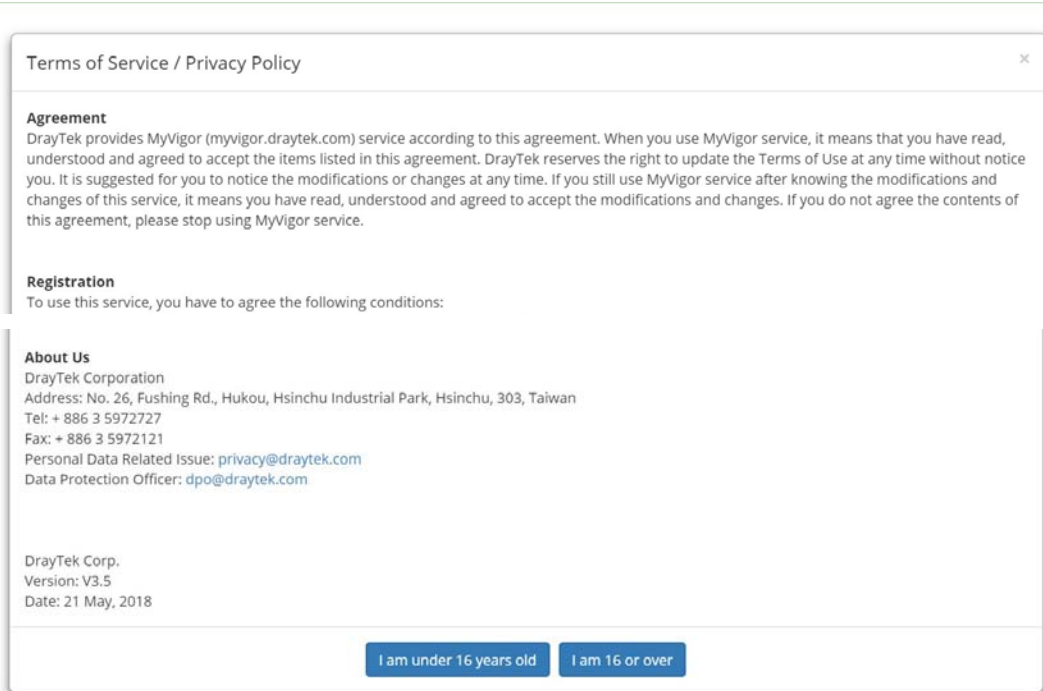

- If not, click I am under 16 years old to get the following page. Then, click I and my legal guardian agree.

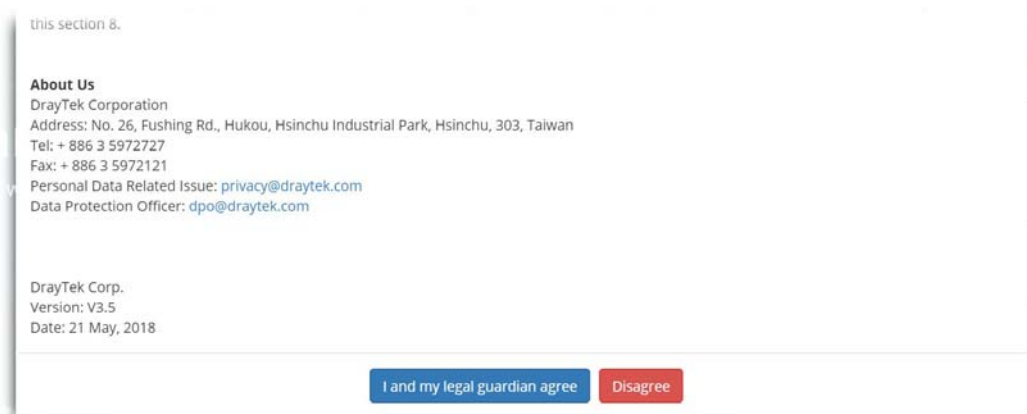

5. After reading the terms of service/privacy policy, click Agree.

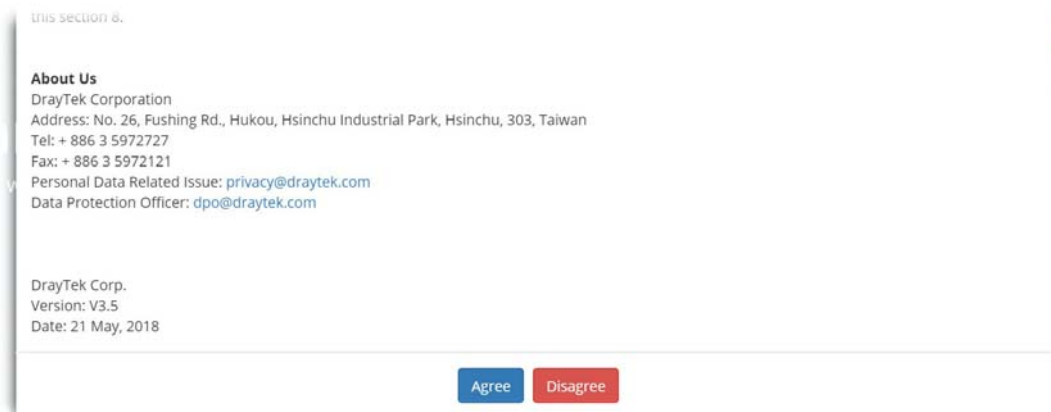

6. In the following page, enter your personal information in this page and then click Continue.



**DrayTek MyVigor** English ▾

Create an account - Please enter personal profile.

**UserName**  
Draytek\_Document

**Email Address**  
draytek@draytek.com

The user account ( Draytek\_Document ) is available. Please complete registration to register this account.

**Country**  
TAIWAN ▾

**Industry**  
Other ▾

**Password**  
.....

**Confirm Password**  
.....

Do you agree to share your information to DrayTek office, regional distributor, local dealer and third party, in order to receive the newsletter or information from us?

Do you agree that MyVigor website can record your IP Address for security purposes?  
Your IP Address record will only be used for the purposes of detecting and preventing malicious login attempts.  
You can change the setting or clear the record at anytime.

I'm not a robot  reCAPTCHA  
Privacy - Terms

**Continue**

Return to Login

7. Choose proper selection for your computer and click Continue.

**DrayTek MyVigor** English ▾

Thank you Draytek\_Document, Your account has been created and an activation link has been sent to dr\*\*\*\*k@draytek.com.

Note that you must activate the account by following the activation link in the email before you can login.

I'm not a robot  reCAPTCHA  
Privacy - Terms

Resend the activation mail

Return to Login

8. Now you have created an account successfully.
9. Check to see the confirmation *email* with the title of New Account Confirmation Letter from myvigor.draytek.com.

\*\*\*\*\* This is an automated message from myvigor.draytek.com.\*\*\*\*\*

Thank you (**Mary**) for creating an account.

Please click on the activation link below to activate your account

Link : [Activate my Account](#)

10. Click the Activate my Account link to enable the account that you created. The following screen will be shown to verify the register process is finished. Please click Login.

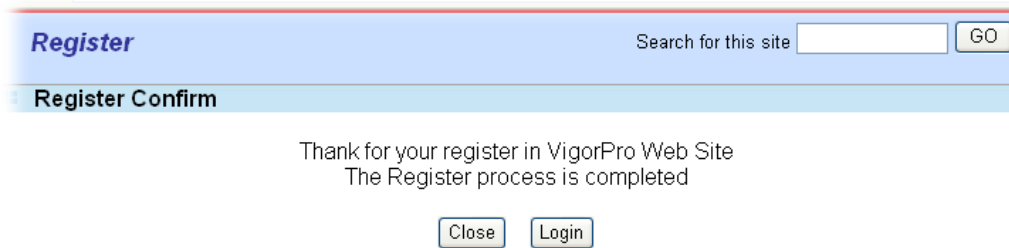

11. When you see the following page, please Enter the account and password (that you just created) in the fields of Username and Password.

The MyVigor website does not record any personal identifiable information with the exception of your IP Address which is recorded after login for security purposes.

ENGLISH

Username  
carrini

Password  
\*\*\*\*\*

**DrayTek**  
MyVigor

Login

Create Account / Get Help

Copyright@DrayTek Corp Terms of Service / Privacy Policy

12. Now, click Login. Your account has been activated. You can access into MyVigor server to activate the service (e.g., WCF) that you want.

## A-2 How to Block Facebook Service Accessed by the Users via Web Content Filter / URL Content Filter

There are two ways to block the facebook service, Web Content Filter and URL Content Filter.

Web Content Filter,

Benefits: Easily and quickly implement the category/website that you want to block.

Note: License is required.

URL Content Filter,

Benefits: Free, flexible for customize webpage.

Note: Manual setting (e.g., one keyword for one website.)

### I. Via Web Content Filter

1. Make sure the Web Content Filter license is valid.

CSM >> Web Content Filter Profile

Web-Filter License Activate  
 [Status:CommTouch] [Start Date:2012-12-31 Expire Date:2013-01-08]

Setup Query Server: auto-selected Find more  
 Setup Test Server: auto-selected Find more

| Profile | Name    | Profile | Name |
|---------|---------|---------|------|
| 1.      | Default | 5.      |      |
| 2.      |         | 6.      |      |
| 3.      |         | 7.      |      |
| 4.      |         | 8.      |      |

Cache: L1 + L2 Cache

Administration Message (Max 255 characters) Default Message

Legend:  
 %SIP% - Source IP, %DIP% - Destination IP, %URL% - URL  
 %CL% - Category, %RNAME% - Router Name

OK

2. Open CSM >> Web Content Filter Profile to create a WCF profile. Check Social Networking with Action, Block.

Child Protection  
 Select All  
 Clear All

Leisure  
 Select All  
 Clear All

Business  
 Select All  
 Clear All

Chatting  
 Select All  
 Clear All

Computer-Internet  
 Select All  
 Clear All

Other

Alcohol & Tobacco  
 Hate & Intolerance  
 Porn & Sexually  
 School Cheating  
 Child Abuse Images

Entertainment  
 Travel

Business  
 Business

Chat  
 Chat

Anonymizers  
 Download Sites  
 Search Engine, Portals  
 Malware  
 Illegal Software

Criminal Activity  
 Illegal Drug  
 Violence  
 Sex Education

Games  
 Leisure & Recreation

Job Search

Instant Messaging

Forums & Newsgroups  
 Streaming Downloads  
 Social Networking (checked)  
 Botnets  
 Information Security

Gambling  
 Nudity  
 Weapons  
 Tasteless

Sports  
 Fashion & Beauty

Web-based Mail

Computers, Technology  
 Phishing & Fraud  
 Spam Sites  
 Hacking  
 Peer-to-Peer

3. Enable this profile in Firewall>>General Setup>>Default Rule.

Firewall >> General Setup

General Setup

**General Setup** | **Default Rule**

Actions for default rule:

| Application        | Action/Profile | Syslog                   |
|--------------------|----------------|--------------------------|
| Filter             | Pass           | <input type="checkbox"/> |
| Sessions Control   | 0 / 60000      | <input type="checkbox"/> |
| Quality of Service | None           | <input type="checkbox"/> |
| User Management    | None           | <input type="checkbox"/> |
| APP Enforcement    | None           | <input type="checkbox"/> |
| URL Content Filter | None           | <input type="checkbox"/> |
| Web Content Filter | None           | <input type="checkbox"/> |
| DNS Filter         | None           | <input type="checkbox"/> |

Advance Setting

OK    Cancel

Backup Firewall:     Restore Firewall:  未選擇任何檔案

**Note:**

This will not backup the detail setting of Quality of Service and Schedule.

4. Next time when someone accesses facebook via this router, the web page would be blocked and the following message would be displayed instead.

The requested Web page  
from 192.168.2.114  
to www.facebook.com/  
that is categorized with [Social Networking]  
has been blocked by Web Content Filter.

Please contact your system administrator for further information.

[Powered by DrayTek]

## II. Via URL Content Filter

### A. Block the web page containing the word of “Facebook”

1. Open Object Settings>>Keyword Object. Click an index number to open the setting page.
2. In the field of Contents, please type *facebook*. Configure the settings as the following figure.

Objects Setting >> Keyword Object Setup

Profile Index : 1

|          |          |
|----------|----------|
| Name     | Facebook |
| Contents | facebook |

Limit of Contents: Max 3 Words and 63 Characters.  
Each word should be separated by a single space.

You can replace a character with %HEX.  
Example:  
Contents: backdoo%72 virus keep%20out

Result:  
1. backdoor  
2. virus  
3. keep out

OK Clear Cancel

3. Open CSM>>URL Content Filter Profile. Click an index number to open the setting page.
4. Configure the settings as the following figure.

CSM >> URL Content Filter Profile

Profile Index: 1

Profile Name: Facebook

Priority: Either : URL Access Control First Log: Block

**URL Access Control**

Enable URL Access Control  Prevent web access from IP address

Action: Pass Group/Object Selections: Facebook Edit

Exception List Edit

**Web Feature**

Enable Web Feature Restriction

Action: Pass File Extension Profile: None  Cookie  Proxy  Upload

OK Clear Cancel

5. When you finished the above steps, click OK. Then, open Firewall>>General Setup.

- Click the Default Rule tab. Choose the profile just configured from the drop down list in the field of URL Content Filter. Now, users cannot open any web page with the word “facebook” inside.

Firewall >> General Setup

---

General Setup

General Setup    Default Rule

| Actions for default rule: | Action/Profile | Syslog                   |
|---------------------------|----------------|--------------------------|
| Application Filter        | Pass           | <input type="checkbox"/> |
| Sessions Control          | 0 / 60000      | <input type="checkbox"/> |
| Quality of Service        | None           | <input type="checkbox"/> |
| User Management           | None           | <input type="checkbox"/> |
| APP Enforcement           | None           | <input type="checkbox"/> |
| URL Content Filter        | 1-Facebook     | <input type="checkbox"/> |
| Web Content Filter        | None           | <input type="checkbox"/> |
| DNS Filter                | None           | <input type="checkbox"/> |

Advance Setting

Backup Firewall :   

Restore Firewall:

**Note:**  
This will not backup the detail setting of Quality of Service and Schedule.

## B. Disallow users to play games on Facebook

- Open Object Settings>>Keyword Object. Click an index number to open the setting page.
- In the field of Contents, please type *apps.facebook*. Configure the settings as the following figure.

Objects Setting >> Keyword Object Setup

---

Profile Index : 2

Name   

Contents   

**Limit of Contents:** Max 3 Words and 63 Characters.  
Each word should be separated by a single space.

You can replace a character with %HEX.  
Example:  
Contents: backdoo%72 virus keep%20out

Result:  
1. backdoor  
2. virus  
3. keep out

- Open CSM>>URL Content Filter Profile. Click an index number to open the setting page.
- Configure the settings as the following figure.

CSM >> URL Content Filter Profile

Profile Index: 2

Profile Name:

Priority:  Log:

**URL Access Control**

Enable URL Access Control       Prevent web access from IP address

Action:       Group/Object Selections

Exception List

**Web Feature**

Enable Web Feature Restriction

Action:       **File Extension Profile:**        Cookie       Proxy       Upload

- When you finished the above steps, please open Firewall>>General Setup.
- Click the Default Rule tab. Choose the profile just configured from the drop down list in the field of URL Content Filter. Now, users cannot open any web page with the word “facebook” inside.

Firewall >> General Setup

General Setup

**General Setup**    **Default Rule**

**Actions for default rule:**

| Application               | Action/Profile                           | Syslog                   |
|---------------------------|------------------------------------------|--------------------------|
| Filter                    | <input type="text" value="Pass"/>        | <input type="checkbox"/> |
| Sessions Control          | <input type="text" value="0 / 60000"/>   | <input type="checkbox"/> |
| Quality of Service        | <input type="text" value="None"/>        | <input type="checkbox"/> |
| User Management           | <input type="text" value="None"/>        | <input type="checkbox"/> |
| APP Enforcement           | <input type="text" value="None"/>        | <input type="checkbox"/> |
| <b>URL Content Filter</b> | <input type="text" value="2-face.apps"/> | <input type="checkbox"/> |
| Web Content Filter        | <input type="text" value="None"/>        | <input type="checkbox"/> |
| DNS Filter                | <input type="text" value="None"/>        | <input type="checkbox"/> |

Advance Setting



# Part VII Management



System  
Maintenance



Bandwidth  
Management



User  
Management

There are several items offered for the Vigor router system setup: System Status, TR-069, Administrator Password, User Password, Login Page Greeting, Configuration Backup, Syslog /Mail Alert, Time and Date, Management, Reboot System, Firmware Upgrade and Activation.

It is used to control the bandwidth of data transmission through configuration of Sessions Limit, Bandwidth Limit, and Quality of Service (QoS).

It is a security feature which disallows any IP traffic (except DHCP-related packets) from a particular host until that host has correctly supplied a valid username and password.

---

## VII-1 System Maintenance

For the system setup, there are several items that you have to know the way of configuration: System Status, TR-069, NetFlow, Administrator Password, User Password, Login Page Greeting, Configuration Backup, Webhook, Syslog /Mail Alert, Time and Date, SNMP, Management, Panel Control, Self-Signed Certificate, Reboot System, Firmware Upgrade, Firmware Backup, Internal Service User List and Dashboard Control.

Below shows the menu items for System Maintenance.

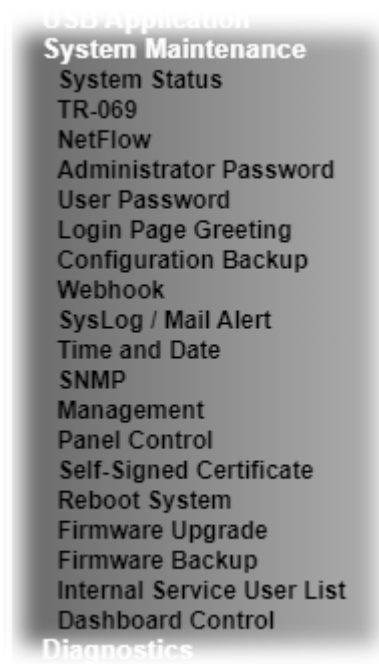

# Web User Interface

## VII-1-1 System Status

The System Status displays basic network information of Vigor router including LAN and WAN interface status. Also available is the current firmware version and firmware related information.

### System Maintenance >> System Status

Model Name : Vigor2927Vac  
 Firmware Version : 4.4.2.2  
 Build Date/Time : Nov 11 2022 11:59:09

| LAN              |                   |               |               |             |         |
|------------------|-------------------|---------------|---------------|-------------|---------|
|                  | MAC Address       | IP Address    | Subnet Mask   | DHCP Server | DNS     |
| LAN1             | 14-49-BC-11-7B-60 | 192.168.1.1   | 255.255.255.0 | ON          | 8.8.8.8 |
| LAN2             | 14-49-BC-11-7B-60 | 192.168.2.1   | 255.255.255.0 | ON          | 8.8.8.8 |
| LAN3             | 14-49-BC-11-7B-60 | 192.168.3.1   | 255.255.255.0 | ON          | 8.8.8.8 |
| LAN4             | 14-49-BC-11-7B-60 | 192.168.4.1   | 255.255.255.0 | ON          | 8.8.8.8 |
| LAN5             | 14-49-BC-11-7B-60 | 192.168.5.1   | 255.255.255.0 | ON          | 8.8.8.8 |
| LAN6             | 14-49-BC-11-7B-60 | 192.168.6.1   | 255.255.255.0 | ON          | 8.8.8.8 |
| LAN7             | 14-49-BC-11-7B-60 | 192.168.7.1   | 255.255.255.0 | ON          | 8.8.8.8 |
| LAN8             | 14-49-BC-11-7B-60 | 192.168.8.1   | 255.255.255.0 | ON          | 8.8.8.8 |
| DMZ PORT         | 14-49-BC-11-7B-60 | 192.168.254.1 | 255.255.255.0 | ON          | 8.8.8.8 |
| IP Routed Subnet | 14-49-BC-11-7B-60 | 192.168.0.1   | 255.255.255.0 | ON          | 8.8.8.8 |

| Wireless LAN(2.4GHz) |                  |                  |         |
|----------------------|------------------|------------------|---------|
| MAC Address          | Frequency Domain | Firmware Version | SSID    |
| 16-49-BC-41-7B-60    | Europe           | 5.0.4.0          | DrayTek |

| Wireless LAN(5GHz) |                  |                  |            |
|--------------------|------------------|------------------|------------|
| MAC Address        | Frequency Domain | Firmware Version | SSID       |
| 14-49-BC-11-7B-60  | Europe           | 5.0.4.0          | DrayTek_5G |

| WAN  |              |                   |             |            |                 |
|------|--------------|-------------------|-------------|------------|-----------------|
|      | Link Status  | MAC Address       | Connection  | IP Address | Default Gateway |
| WAN1 | Disconnected | 14-49-BC-11-7B-61 | DHCP Client | ---        | ---             |
| WAN2 | Disconnected | 14-49-BC-11-7B-62 | DHCP Client | ---        | ---             |
| WAN3 | Disconnected | 12-59-BC-11-7B-60 | ---         | ---        | ---             |
| WAN4 | Disconnected | 12-49-BC-11-7B-60 | ---         | ---        | ---             |
| WAN5 | Disconnected | 14-49-BC-11-7B-65 | ---         | ---        | ---             |
| WAN6 | Disconnected | 14-49-BC-11-7B-66 | ---         | ---        | ---             |

| IPv6 |                              |       |                      |
|------|------------------------------|-------|----------------------|
|      | Address                      | Scope | Internet Access Mode |
| LAN  | FE80::1649:BCFF:FE11:7B60/64 | Link  | ---                  |

| VoIP   |         |      |        |
|--------|---------|------|--------|
| Port   | Profile | Reg. | In/Out |
| Phone1 |         | No   | 0/0    |
| Phone2 |         | No   | 0/0    |

Available settings are explained as follows:

| Item             | Description                                                                                                                                     |
|------------------|-------------------------------------------------------------------------------------------------------------------------------------------------|
| Model Name       | Displays the model name of the router.                                                                                                          |
| Firmware Version | Displays the firmware version of the router.                                                                                                    |
| Build Date/Time  | Displays the date and time of the current firmware build.                                                                                       |
| LAN              | MAC Address<br>- Displays the MAC address of the LAN Interface.<br>IP Address<br>- Displays the IP address of the LAN interface.<br>Subnet Mask |

|              |                                                                                                                                                                                                                                                                                                                                                                                                                                                                                                                                                                                                                                        |
|--------------|----------------------------------------------------------------------------------------------------------------------------------------------------------------------------------------------------------------------------------------------------------------------------------------------------------------------------------------------------------------------------------------------------------------------------------------------------------------------------------------------------------------------------------------------------------------------------------------------------------------------------------------|
|              | <ul style="list-style-type: none"> <li>- Displays the subnet mask address of the LAN interface.</li> </ul> <p>DHCP Server</p> <ul style="list-style-type: none"> <li>- Displays the current status of DHCP server of the LAN interface.</li> </ul> <p>DNS</p> <ul style="list-style-type: none"> <li>- Displays the assigned IP address of the primary DNS.</li> </ul>                                                                                                                                                                                                                                                                 |
| Wireless LAN | <p>MAC Address</p> <ul style="list-style-type: none"> <li>- Displays the MAC address of the LAN Interface.</li> </ul> <p>Frequency Domain</p> <ul style="list-style-type: none"> <li>- Displays the frequency domain.</li> </ul> <p>Firmware Version</p> <ul style="list-style-type: none"> <li>- Displays the firmware version.</li> </ul> <p>SSID</p> <ul style="list-style-type: none"> <li>- Displays the name of the SSID.</li> </ul>                                                                                                                                                                                             |
| WAN          | <p>Link Status</p> <ul style="list-style-type: none"> <li>- Displays current connection status of the WAN interface.</li> </ul> <p>MAC Address</p> <ul style="list-style-type: none"> <li>- Displays the MAC address of the WAN Interface.</li> </ul> <p>Connection</p> <ul style="list-style-type: none"> <li>- Displays the connection type of the WAN interface..</li> </ul> <p>IP Address</p> <ul style="list-style-type: none"> <li>- Displays the IP address of the WAN interface.</li> </ul> <p>Default Gateway</p> <ul style="list-style-type: none"> <li>- Display the assigned IP address of the default gateway.</li> </ul> |
| IPv6         | <p>Address - Displays the IPv6 address for LAN.</p> <p>Scope - Displays the scope of IPv6 address. For example, IPv6 Link Local is non-routable and can only be used for local connections.</p> <p>Internet Access Mode - Displays the connection mode of the WAN interface.</p>                                                                                                                                                                                                                                                                                                                                                       |

## VII-1-2 TR-069

This device supports the TR-069 standard for remote management of customer-premises equipment (CPE) through an Auto Configuration Server, such as VigorACS.

### VII-1-2-1 ACS and CPE Settings

System Maintenance >> TR-069 Setting



| ACS and CPE Settings                                                                                                                               | Reporting Configuration                                    | Export Parameters |
|----------------------------------------------------------------------------------------------------------------------------------------------------|------------------------------------------------------------|-------------------|
| TR-069 <input checked="" type="radio"/> Disable <input type="radio"/> Enable                                                                       |                                                            |                   |
| <b>Primary ACS Server</b>                                                                                                                          |                                                            |                   |
| ACS Server On                                                                                                                                      | Internet                                                   |                   |
| <input checked="" type="checkbox"/> Enable TR069 Server on <a href="#">System Maintenance &gt;&gt; Management &gt;&gt; Internet Access Control</a> |                                                            |                   |
| URL                                                                                                                                                | <input type="text"/> <input type="button" value="Wizard"/> |                   |
| <input type="checkbox"/> Acquire URL from DHCP option 43                                                                                           |                                                            |                   |
| Username                                                                                                                                           | Max: 31 characters                                         |                   |
| Password                                                                                                                                           | Max: 31 characters                                         |                   |
| <b>STUN Settings</b> <input type="radio"/> Enable <input checked="" type="radio"/> Disable                                                         |                                                            |                   |
| Server Address                                                                                                                                     | <input type="text"/>                                       |                   |
| Server STUN Port                                                                                                                                   | 3478                                                       |                   |
| Minimum Keep Alive Period                                                                                                                          | 60                                                         | second(s)         |
| Maximum Keep Alive Period                                                                                                                          | -1                                                         | second(s)         |

Available settings are explained as follows:

| Item               | Description                                                                                                                                                                                                                                                                                                                                                                                                                                                                                                                                                                                                                                                                                                                                                                                                                                                                                                                                                                                    |
|--------------------|------------------------------------------------------------------------------------------------------------------------------------------------------------------------------------------------------------------------------------------------------------------------------------------------------------------------------------------------------------------------------------------------------------------------------------------------------------------------------------------------------------------------------------------------------------------------------------------------------------------------------------------------------------------------------------------------------------------------------------------------------------------------------------------------------------------------------------------------------------------------------------------------------------------------------------------------------------------------------------------------|
| TR-069             | Enables or disables TR-069 functionality.                                                                                                                                                                                                                                                                                                                                                                                                                                                                                                                                                                                                                                                                                                                                                                                                                                                                                                                                                      |
| Primary ACS Server | <p>This section specifies the settings of the ACS Server.</p> <p>ACS Server On - Choose the interface for connecting the router to the Auto Configuration Server.</p> <p>Enable TR069 Server on System Maintenance&gt;&gt;Management&gt;&gt;Internet Access Control - If enabled, a user will be allowed to access into TR-069 from WAN.</p> <p>URL - Enter the URL for connecting to the ACS.</p> <p>Wizard - Click it to enter the IP address of VigorACS server, port number and the handler.</p> <p>Acquire URL form DHCP option 43 - Check the box to get the URL from DHCP option 43.</p> <p>Username/Password - Enter the credentials required to connect to the ACS server.</p> <p>STUN Settings - The default is Disable. If select Enable, please type the relational settings listed below:</p> <ul style="list-style-type: none"> <li>● Server Address - Type the IP address of the STUN server.</li> <li>● Server STUN Port - Type the port number of the STUN server.</li> </ul> |

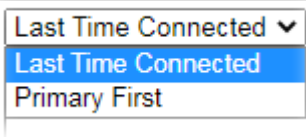
|                      |                                                                                                                                                                                                                                                                                                                                                                                                                                                                                                                                                                                                                                                                                                                                                                                                                                                                                                                                                                                                                                                                                                                                                                                                                                                                                                                                                                                                                                                                                                                                                                               |
|----------------------|-------------------------------------------------------------------------------------------------------------------------------------------------------------------------------------------------------------------------------------------------------------------------------------------------------------------------------------------------------------------------------------------------------------------------------------------------------------------------------------------------------------------------------------------------------------------------------------------------------------------------------------------------------------------------------------------------------------------------------------------------------------------------------------------------------------------------------------------------------------------------------------------------------------------------------------------------------------------------------------------------------------------------------------------------------------------------------------------------------------------------------------------------------------------------------------------------------------------------------------------------------------------------------------------------------------------------------------------------------------------------------------------------------------------------------------------------------------------------------------------------------------------------------------------------------------------------------|
|                      | <ul style="list-style-type: none"> <li>● Minimum Keep Alive Period - If STUN is enabled, the CPE must send binding request to the server for the purpose of maintaining the binding in the Gateway. Please type a number as the minimum period. The default setting is “60 seconds”.</li> <li>● Maximum Keep Alive Period - If STUN is enabled, the CPE must send binding request to the server for the purpose of maintaining the binding in the Gateway. Please type a number as the maximum period. A value of “-1” indicates that no maximum period is specified.</li> </ul>                                                                                                                                                                                                                                                                                                                                                                                                                                                                                                                                                                                                                                                                                                                                                                                                                                                                                                                                                                                              |
| Secondary ACS Server | <p>Mode - Choose Primary First if this server will act as a backup server.</p>  <p>ACS Server On - Choose the interface for connecting the router to the Auto Configuration Server.</p> <p>Enable TR069 Server on System Maintenance&gt;&gt;Management&gt;&gt;Internet Access Control - If enabled, a user will be allowed to access into TR-069 from WAN.</p> <p>URL - Enter the URL for connecting to the ACS.</p> <p>Wizard - Click it to enter the IP address of VigorACS server, port number and the handler.</p> <p>Username/Password - Such data must be typed according to the ACS (Auto Configuration Server) you want to link.</p> <p>STUN Settings - The default is Disable. If select Enable, please type the relational settings listed below:</p> <ul style="list-style-type: none"> <li>● Server Address - Type the IP address of the STUN server.</li> <li>● Server STUN Port - Type the port number of the STUN server.</li> <li>● Minimum Keep Alive Period - If STUN is enabled, the CPE must send binding request to the server for the purpose of maintaining the binding in the Gateway. Please type a number as the minimum period. The default setting is “60 seconds”.</li> <li>● Maximum Keep Alive Period - If STUN is enabled, the CPE must send binding request to the server for the purpose of maintaining the binding in the Gateway. Please type a number as the maximum period. A value of “-1” indicates that no maximum period is specified.</li> </ul> |
| Status               | <p>Last Inform Response Time - Display the time that VigorACS server made a response while receiving Inform message from CPE last time.</p> <p>Test With Inform - Click it to send a message based on the event code selection to test if such CPE is able to communicate with VigorACS SI server.</p> <p>Event Code - Use the drop down menu to specify an event to perform the test.</p>                                                                                                                                                                                                                                                                                                                                                                                                                                                                                                                                                                                                                                                                                                                                                                                                                                                                                                                                                                                                                                                                                                                                                                                    |
| CPE Client           | <p>This section specifies the settings of the CPE Client.</p> <p>Protocol - Select Https if the connection is encrypted;</p>                                                                                                                                                                                                                                                                                                                                                                                                                                                                                                                                                                                                                                                                                                                                                                                                                                                                                                                                                                                                                                                                                                                                                                                                                                                                                                                                                                                                                                                  |

|                          |                                                                                                                                                                                                                                                                                                                                                                                                                                                                                                                                                                                                                                                                                                                                                                                                                                                                                              |
|--------------------------|----------------------------------------------------------------------------------------------------------------------------------------------------------------------------------------------------------------------------------------------------------------------------------------------------------------------------------------------------------------------------------------------------------------------------------------------------------------------------------------------------------------------------------------------------------------------------------------------------------------------------------------------------------------------------------------------------------------------------------------------------------------------------------------------------------------------------------------------------------------------------------------------|
|                          | <p>otherwise select Http.</p> <p>Port - In the event of port conflicts, change the port number of the CPE.</p> <p>Username and Password - Enter the username and password that the VigorACS will use to connect to the CPE.</p>                                                                                                                                                                                                                                                                                                                                                                                                                                                                                                                                                                                                                                                              |
| Periodic Inform Settings | <p>Enable - The default setting is Enable, which means the CPE Client will periodically connect to the ACS Server to update its connection parameters at intervals specified in the Interval Time field.</p> <ul style="list-style-type: none"> <li>● Time Interval - Set interval time or schedule time for the router to send notification to CPE.</li> </ul> <p>Disable - Select Disable to turn off periodic notifications.</p>                                                                                                                                                                                                                                                                                                                                                                                                                                                          |
| Apply Settings to APs    | <p>This feature is able to apply TR-069 settings (including STUN and ACS server settings) to all of APs managed by Vigor2927 at the same time.</p> <p>Disable - TR-069 and Related settings will not be applied to VigorAPs.</p> <p>Enable - TR-069 settings will be applied to VigorAPs after clicking OK. The VigorAP password must be specified.</p> <ul style="list-style-type: none"> <li>● AP Password - Enter the password of the VigorAP that you want to apply Vigor2135's TR-069 settings.</li> <li>● Specify STUN Settings for APs - After clicking the Enable radio button for Apply Settings to APs, if you want to apply specific STUN settings (i.e., different from the Vigor2865 STUN settings) to VigorAPs to meet specific requirements, check this box and enter the server IP address, server port, and minimum and maximum keep alive periods respectively.</li> </ul> |

Select OK to save changes on the page, or Clear to reset all settings to factory defaults.

## VII-1-2-2 Reporting Configuration

Information related to the router's health are divided into several categories and listed in this field. After checking the item(s), Vigor router will arrange and send corresponding data to VigorACS as a reference for the system administrator.

System Maintenance >> TR-069 Setting

| ACS and CPE Settings                                                                                                                                                                                                                                                                                                                                                                                                          | Reporting Configuration | Export Parameters |
|-------------------------------------------------------------------------------------------------------------------------------------------------------------------------------------------------------------------------------------------------------------------------------------------------------------------------------------------------------------------------------------------------------------------------------|-------------------------|-------------------|
| <p><b>CPE Notification Settings</b></p> <p><input type="checkbox"/> Enable</p> <ul style="list-style-type: none"> <li><input type="checkbox"/> Web Login</li> <li><input type="checkbox"/> Web Configuration</li> <li><input type="checkbox"/> High Availability</li> <li><input type="checkbox"/> Bandwidth Utilization</li> <li><input type="checkbox"/> SSH Login</li> <li><input type="checkbox"/> SSH Command</li> </ul> |                         |                   |
| <input type="button" value="OK"/>                                                                                                                                                                                                                                                                                                                                                                                             |                         |                   |

Available settings are explained as follows:

| Item                      | Description                                                |
|---------------------------|------------------------------------------------------------|
| CPE Notification Settings | Enable - Check the box to select the notification item(s). |

---

Vigor router will send the utilization status to VigorACS.

---

Click OK to save changes on the page.

### VII-1-2-3 Export Parameters

Click Export to save the TR-069 parameter settings as an ".xml".

System Maintenance >> TR-069 Setting

---

|                      |                   |                   |
|----------------------|-------------------|-------------------|
| ACS and CPE Settings | Health Parameters | Export Parameters |
|----------------------|-------------------|-------------------|

Export

Export tr069 parameters by xml.

---

### VII-1-3 NetFlow

This page allows you to set the IP address, port number, versions and timeout for collecting packet information monitored by NetFlow feature.

System Maintenance >> NetFlow

Enable

Collector IP

Collector Port

Version  ▼

Active Timeout  second(s)

Inactive Timeout  second(s)

Available settings are explained as follows:

| Item             | Description                                                                                                                                                                                             |
|------------------|---------------------------------------------------------------------------------------------------------------------------------------------------------------------------------------------------------|
| Enable           | Enable - Check the box to enable the NetFlow function.                                                                                                                                                  |
| Collector IP     | Enter the IP address of a server (e.g., VigorConnect) which can be used as the flow collector.                                                                                                          |
| Collector Port   | Enter the port number of the server.                                                                                                                                                                    |
| Version          | The router supports three versions (v5, v9 and IPFIX) of NetFlow feature.                                                                                                                               |
| Active Timeout   | Range from 60 to 1800 seconds. Default is 300 (seconds). Set the time interval of activity that marks a flow active. The data flow information will be collected continuously until the active timeout. |
| Inactive Timeout | Range from 15 to 1800 seconds. Set the time interval of inactivity that marks a flow inactive. The collected data information will be exported after the inactive time interval.                        |

Click OK to save changes on the page.



## VII-1-4 Administrator Password

This page allows you to set or change the administrator password.

System Maintenance >> Administrator Password Setup

### Administrator Password

|                                                                                                                                                           |                                                                                                                 |
|-----------------------------------------------------------------------------------------------------------------------------------------------------------|-----------------------------------------------------------------------------------------------------------------|
| Old Password                                                                                                                                              | <input type="text" value="Max: 83 characters"/>                                                                 |
| New Password                                                                                                                                              | <input type="text" value="Max: 83 characters"/>                                                                 |
| Confirm Password                                                                                                                                          | <input type="text" value="Max: 83 characters"/>                                                                 |
| Password Strength:                                                                                                                                        | <input type="button" value="Weak"/> <input type="button" value="Medium"/> <input type="button" value="Strong"/> |
| Strong password requirements:<br>1. Have at least one upper-case letter and one lower-case letter.<br>2. Including non-alphanumeric characters is a plus. |                                                                                                                 |
| <input checked="" type="checkbox"/> Enable 'admin' account login to Web UI from the Internet                                                              |                                                                                                                 |
| <input type="checkbox"/> Enable Advanced Authentication method when login from "WAN"                                                                      |                                                                                                                 |
| <input type="radio"/> Time-based One-time Password (TOTP)                                                                                                 |                                                                                                                 |
| <input checked="" type="radio"/> Mobile one-Time Passwords(mOTP)                                                                                          |                                                                                                                 |
| PIN Code                                                                                                                                                  | <input type="text" value="*****"/> Secret <input type="text" value="*****"/>                                    |
| <input type="radio"/> 2-Step Authentication                                                                                                               |                                                                                                                 |
| Send Auth code via                                                                                                                                        |                                                                                                                 |
| <input type="checkbox"/> SMS Profile                                                                                                                      | <input type="text" value="1-???"/> Recipient Number <input type="text"/>                                        |
| <input type="checkbox"/> Mail Profile                                                                                                                     | <input type="text" value="1-???"/> Mail Address <input type="text"/>                                            |

#### Note:

Password can contain only a-z A-Z 0-9 , ; : " < > \* + = | ? @ # ^ ! ( )

### Administrator Local User

| <input type="checkbox"/> Enable Local User                                                                                                                                              |                                                                           |       |             |      |             |  |  |  |  |
|-----------------------------------------------------------------------------------------------------------------------------------------------------------------------------------------|---------------------------------------------------------------------------|-------|-------------|------|-------------|--|--|--|--|
| <b>Specific User</b>                                                                                                                                                                    |                                                                           |       |             |      |             |  |  |  |  |
| User Name                                                                                                                                                                               | <input type="text" value="Max: 15 characters"/>                           |       |             |      |             |  |  |  |  |
| Password                                                                                                                                                                                | <input type="text" value="Max: 15 characters"/>                           |       |             |      |             |  |  |  |  |
| Confirm Password                                                                                                                                                                        | <input type="text" value="Max: 15 characters"/>                           |       |             |      |             |  |  |  |  |
| <input type="radio"/> User Name and Password only                                                                                                                                       |                                                                           |       |             |      |             |  |  |  |  |
| <input type="radio"/> Time-based One-time Password (TOTP)                                                                                                                               |                                                                           |       |             |      |             |  |  |  |  |
| <input type="radio"/> Mobile one-Time Passwords(mOTP)                                                                                                                                   |                                                                           |       |             |      |             |  |  |  |  |
| <input type="radio"/> 2-Step Authentication                                                                                                                                             |                                                                           |       |             |      |             |  |  |  |  |
| <input type="checkbox"/> Enable Advanced Authentication method when login from "WAN"                                                                                                    |                                                                           |       |             |      |             |  |  |  |  |
| <input type="button" value="Add"/>                                                                                                                                                      | <input type="button" value="Edit"/> <input type="button" value="Delete"/> |       |             |      |             |  |  |  |  |
| <b>Local User List</b>                                                                                                                                                                  |                                                                           |       |             |      |             |  |  |  |  |
| <table border="1"><thead><tr><th>Index</th><th>User Name</th><th>Type</th><th>Destination</th></tr></thead><tbody><tr><td colspan="4" style="height: 100px;"></td></tr></tbody></table> |                                                                           | Index | User Name   | Type | Destination |  |  |  |  |
| Index                                                                                                                                                                                   | User Name                                                                 | Type  | Destination |      |             |  |  |  |  |
|                                                                                                                                                                                         |                                                                           |       |             |      |             |  |  |  |  |

### Administrator LDAP Setting



|                                                               |
|---------------------------------------------------------------|
| <input type="checkbox"/> Enable LDAP/AD login for admin users |
| LDAP Server <a href="#">Profiles Setup</a>                    |

### Administrator TACACS+ Setting

|                                                                      |
|----------------------------------------------------------------------|
| <input type="checkbox"/> Enable TACACS+ login for admin users        |
| <input checked="" type="checkbox"/> Fallback to Local Authentication |

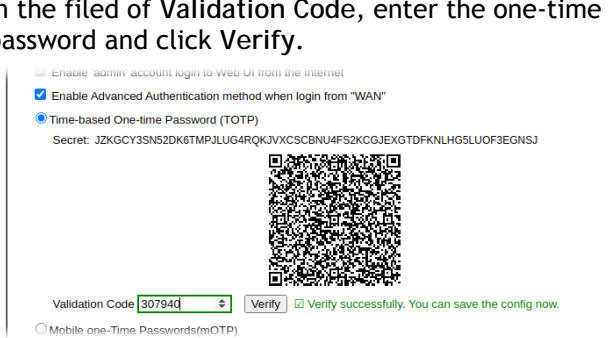
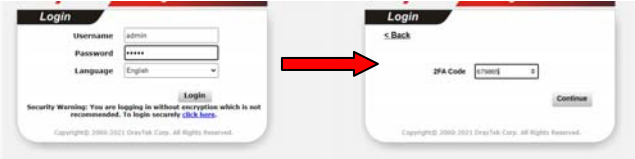
Available settings are explained as follows:

| Item                   | Description                                                                                                                                                                                                                                                                                                                                                                                                                                                                                                                                                                                                                                                                                                                                                                                                                                                                                                                                                                                                                                                                                                                                                                                                                                                                                                                                                                                                                                                                                                                                                                                                                                                                                                                                                                                                                                                        |
|------------------------|--------------------------------------------------------------------------------------------------------------------------------------------------------------------------------------------------------------------------------------------------------------------------------------------------------------------------------------------------------------------------------------------------------------------------------------------------------------------------------------------------------------------------------------------------------------------------------------------------------------------------------------------------------------------------------------------------------------------------------------------------------------------------------------------------------------------------------------------------------------------------------------------------------------------------------------------------------------------------------------------------------------------------------------------------------------------------------------------------------------------------------------------------------------------------------------------------------------------------------------------------------------------------------------------------------------------------------------------------------------------------------------------------------------------------------------------------------------------------------------------------------------------------------------------------------------------------------------------------------------------------------------------------------------------------------------------------------------------------------------------------------------------------------------------------------------------------------------------------------------------|
| Administrator Password | <p>The administrator can login web user interface of Vigor router to modify all of the settings to fit the requirements.</p> <p>Old Password - Enter the current password. The factory default is “admin”.</p> <p>New Password - Enter the new password. The maximum length of the password is 23 characters.</p> <p>Confirm Password - Enter the new password again for confirmation.</p> <p>Password Strength - Shows the security strength of the password specified above.</p> <p>Enable ‘admin’ account login to Web UI from the Internet - Select to allow the administrator to log in from the Internet. This option is enabled when Administrator Local User is enabled (see below).</p> <p>Use only advanced authentication method for Admin “WAN” login - Advanced authentication method can offer a more secure network connection. Select to require TOTP, mOTP or 2-step authentication when logging in from the WAN.</p> <ul style="list-style-type: none"> <li>● Time-based One-time Password (TOTP) - Please make sure the time zone of your router is correct. Then, install Google Authenticator APP on your cell phone. Open the APP to scan the QR code on this page. A one-time password will be shown on your phone.</li> </ul>  <p>In the field of Validation Code, enter the one-time password and click Verify.</p>  <p>Now, the configuration is finished. You will be asked to enter the 2FA code on the after passing the username and password authentication.</p>  <ul style="list-style-type: none"> <li>● Mobile one-Time Password (mOTP) - Select to allow</li> </ul> |

|                                 |                                                                                                                                                                                                                                                                                                                                                                                                                                                                                                                                                                                                                                                                                                                                                                                                                                                                                                                                                                                                                                                                                                                                                                                                                                                                                                                                                                                                                                                                                                                                                                                                                                                                                                                                                                                                                                                                                                                                                                                                                                                                                                                                                                                                                                                                                                                                                                                                                                                                                                                                                                                                                                                                                                                                                                                                                                                                                                                                            |
|---------------------------------|--------------------------------------------------------------------------------------------------------------------------------------------------------------------------------------------------------------------------------------------------------------------------------------------------------------------------------------------------------------------------------------------------------------------------------------------------------------------------------------------------------------------------------------------------------------------------------------------------------------------------------------------------------------------------------------------------------------------------------------------------------------------------------------------------------------------------------------------------------------------------------------------------------------------------------------------------------------------------------------------------------------------------------------------------------------------------------------------------------------------------------------------------------------------------------------------------------------------------------------------------------------------------------------------------------------------------------------------------------------------------------------------------------------------------------------------------------------------------------------------------------------------------------------------------------------------------------------------------------------------------------------------------------------------------------------------------------------------------------------------------------------------------------------------------------------------------------------------------------------------------------------------------------------------------------------------------------------------------------------------------------------------------------------------------------------------------------------------------------------------------------------------------------------------------------------------------------------------------------------------------------------------------------------------------------------------------------------------------------------------------------------------------------------------------------------------------------------------------------------------------------------------------------------------------------------------------------------------------------------------------------------------------------------------------------------------------------------------------------------------------------------------------------------------------------------------------------------------------------------------------------------------------------------------------------------------|
|                                 | <p>the use of mOTP passwords. Enter the PIN Code and Secret settings for getting one-time passwords.</p> <ul style="list-style-type: none"> <li>● 2-Step Auth code via <u>SMS Profile</u> and/or <u>Mail Profile</u> - Select the SMS and/or Mail profiles and the destination SMS number and/or email address for transmitting the password.</li> </ul>                                                                                                                                                                                                                                                                                                                                                                                                                                                                                                                                                                                                                                                                                                                                                                                                                                                                                                                                                                                                                                                                                                                                                                                                                                                                                                                                                                                                                                                                                                                                                                                                                                                                                                                                                                                                                                                                                                                                                                                                                                                                                                                                                                                                                                                                                                                                                                                                                                                                                                                                                                                   |
| <p>Administrator Local User</p> | <p>Usually, the system administrator has the highest privilege to modify the settings on the web user interface of the Vigor router. However, in some cases, it might be necessary to have other users in LAN to access into the web user interface of Vigor router.</p> <p>This feature allows you to add more administrators who can then log in to the web interface, with the same privileges as the administrator.</p> <p>Enable Local User - Check the box to allow other users to administer the router.</p> <p>Specific User - Create the new user account as the local user. Then specify the authentication method (dividing into Basic and Advanced) for the user account.</p> <ul style="list-style-type: none"> <li>● User Name - Enter a user name.</li> <li>● Password - Enter the password for the local user.</li> <li>● Confirm Password - Enter the new password again for confirmation.</li> <li>● User Name and Password only - If selected, you need to enter a user name and password.</li> <li>● Time-based One-time Password (TOTP) - Please make sure the time zone of your router is correct. Then, install Google Authenticator APP on your cell phone. Open the APP to scan the QR code on this page. A one-time password will be shown on your phone.</li> </ul> <div data-bbox="778 1227 1396 1473" style="border: 1px solid #ccc; padding: 5px;"> <p><input checked="" type="checkbox"/> Enable Advanced Authentication method when login from "WAN"</p> <p><input checked="" type="radio"/> Time-based One-time Password (TOTP)</p> <p>Secret: ISQUC3CEGNLWIU3DNFAUGY2OMFKU22LKMFTG22TLNBRTQWLXJ5FGSOTFJU4GE22V</p>  <p>Validation Code: <input type="text"/> <input type="button" value="Verify"/></p> <p><input type="radio"/> Mobile one-Time Passwords(mOTP)</p> </div> <p>In the field of Validation Code, enter the one-time password and click Verify.</p> <div data-bbox="778 1563 1396 1832" style="border: 1px solid #ccc; padding: 5px;"> <p><input type="checkbox"/> Enable "admin" account login to Web UI from the Internet</p> <p><input checked="" type="checkbox"/> Enable Advanced Authentication method when login from "WAN"</p> <p><input checked="" type="radio"/> Time-based One-time Password (TOTP)</p> <p>Secret: JZKGCY3SN52DK6TMPJLUG4RQKJXVCSCBNU4FS2KCGJEXGTFDKNLHG5LUOF3EGNSJ</p>  <p>Validation Code: <input type="text" value="30794Q"/> <input type="button" value="Verify"/> <input checked="" type="checkbox"/> Verify successfully. You can save the config now.</p> <p><input type="radio"/> Mobile one-Time Passwords(mOTP)</p> </div> <p>Now, the configuration is finished. You will be asked to enter the 2FA code on the after passing the username and password authentication.</p> |

|                                      |                                                                                                                                                                                                                                                                                                                                                                                                                                                                                                                                                                                                                                                                                                                                                                                                                                                                                                                                                                                                                                                                                                                                                                                                                                                                                                                                     |
|--------------------------------------|-------------------------------------------------------------------------------------------------------------------------------------------------------------------------------------------------------------------------------------------------------------------------------------------------------------------------------------------------------------------------------------------------------------------------------------------------------------------------------------------------------------------------------------------------------------------------------------------------------------------------------------------------------------------------------------------------------------------------------------------------------------------------------------------------------------------------------------------------------------------------------------------------------------------------------------------------------------------------------------------------------------------------------------------------------------------------------------------------------------------------------------------------------------------------------------------------------------------------------------------------------------------------------------------------------------------------------------|
|                                      |  <ul style="list-style-type: none"> <li>● Mobile one-Time Password (mOTP) - Select to allow the use of mOTP passwords. Enter the mOTP PIN Code and Secret that will be used to generate the one-time passwords.</li> <li>● 2-Step Authentication via <u>SMS Profile</u> and/or <u>Mail Profile</u> - Select the SMS and/or Mail profiles and the destination SMS number and/or email address for transmitting the password.</li> <li>● Enable Advanced Authentication method when login from "WAN"- Advanced authentication method can offer a more secure network connection. Select to require mOTP or TOTP or 2-step authentication when logging in from the WAN.</li> <li>● Add - After entering the user name and password above, click this button to create a new local user. The new user will be shown on the Local User List immediately.</li> <li>● Edit - If you wish to change a user in the Local User List, select it, perform the necessary modifications, and click this button to update the user.</li> <li>● Delete - If you wish to delete a user in the Local User List, select it and click this button to remove it.</li> <li>● Local User List - Shows all the users that are set up to administer the router.</li> </ul> |
| <b>Administrator LDAP Setting</b>    | Enable LDAP/AD login for admin users - Select to allow authentication using an LDAP/Active Directory Server.<br>LDAP Server <u>Profiles Setup</u> - Click to set up the LDAP/Active Directory server.                                                                                                                                                                                                                                                                                                                                                                                                                                                                                                                                                                                                                                                                                                                                                                                                                                                                                                                                                                                                                                                                                                                               |
| <b>Administrator TACACS+ Setting</b> | Enable TACACS+ login for admin users - If it is enabled, any user can access into the web user interface of Vigor router through the TACACS+ server authentication. <ul style="list-style-type: none"> <li>● Fallback to local Authentication - If it is enabled, the administrator can use other login methods for authentication once the TACACS+ server has no response.</li> </ul>                                                                                                                                                                                                                                                                                                                                                                                                                                                                                                                                                                                                                                                                                                                                                                                                                                                                                                                                              |

Click OK to save changes on the page, and you will be directed to the login screen. Please log in with the new password.

## VII-1-5 User Password

This page allows you to set new password for user operation.

System Maintenance >> User Password

Enable User Mode for simple web configuration

User Password

| [Set to Factory Default](#) |

|                                                                   |                                                                                                                 |
|-------------------------------------------------------------------|-----------------------------------------------------------------------------------------------------------------|
| Password                                                          | Max: 23 characters                                                                                              |
| Confirm Password                                                  | Max: 23 characters                                                                                              |
| Password Strength:                                                | <input type="button" value="Weak"/> <input type="button" value="Medium"/> <input type="button" value="Strong"/> |
| Strong password requirements:                                     |                                                                                                                 |
| 1. Have at least one upper-case letter and one lower-case letter. |                                                                                                                 |
| 2. Including non-alphanumeric characters is a plus.               |                                                                                                                 |

Note:

1. Password can contain a-z A-Z 0-9 , ; : . " < > \* + = | ? @ # ^ ! ( )
2. Password can't be all asterisks(\*). For example, '\*' or '\*\*\*\*' is illegal, but '123\*' or '\*45' is OK.

Available settings are explained as follows:

| Item                                          | Description                                                                                                                                                                                                                                                        |
|-----------------------------------------------|--------------------------------------------------------------------------------------------------------------------------------------------------------------------------------------------------------------------------------------------------------------------|
| Enable User Mode for simple web configuration | Check this box to enable User Mode for web user interface with the password typed here for simple web configuration. The simple web user interface settings differ from those on the full web user interface seen when logged in using the administrator password. |
| Password                                      | Enter the password. The maximum length of the password is 31 characters.                                                                                                                                                                                           |
| Confirm Password                              | Enter the password again for verification.                                                                                                                                                                                                                         |
| Password Strength                             | Shows the security strength of the password specified above.                                                                                                                                                                                                       |
| Set to Factory Default                        | Click to return to the factory default setting.                                                                                                                                                                                                                    |

Click OK to save changes on the page, and you will be directed to the login screen. Please window will appear. Please log in with the new password.

Here are the steps involved in setting up the router for User Mode Access:

1. Navigate to System Maintenance>>User Password in the web user interface.
2. Check the box of Enable User Mode for simple web configuration to enable user mode operation. Enter a new password in the Password field and click OK.

System Maintenance >> User Password

Enable User Mode for simple web configuration

User Password

[Set to Factory Default](#)

|                                                                   |                                        |
|-------------------------------------------------------------------|----------------------------------------|
| Password                                                          | <input type="password" value="*****"/> |
| Confirm Password                                                  | <input type="password" value="*****"/> |
| Password Strength:                                                | Weak <b>Medium</b> Strong              |
| Strong password requirements:                                     |                                        |
| 1. Have at least one upper-case letter and one lower-case letter. |                                        |
| 2. Including non-alphanumeric characters is a plus.               |                                        |

Note:

1. Password can contain a-z A-Z 0-9 , ; : . " < > \* + = | ? @ # ^ ! ( )
2. Password can't be all asterisks(\*). For example, '\*\*\*' or '\*\*\*\*\*' is illegal, but '123\*\*' or '\*\*45' is OK.

OK

3. The following screen will appear. Click OK.

System Maintenance >> User Password

Active Configuration

|          |         |
|----------|---------|
| Password | : ***** |
|----------|---------|

4. Log out the Vigor router web user interface by clicking the Logout button.



5. The following window will be shown. Enter the new user password in the Password field and click Login.

**DrayTek** **Vigor2927 Series**

**Login**

Username

Password

The username or password you entered is incorrect.

Login

**Security Warning: You are logging in without encryption which is not recommended. To login securely [click here](#).**

Copyright © 2000-2020 DrayTek Corp. All Rights Reserved.

6. The main screen with User Mode will be shown as follows:

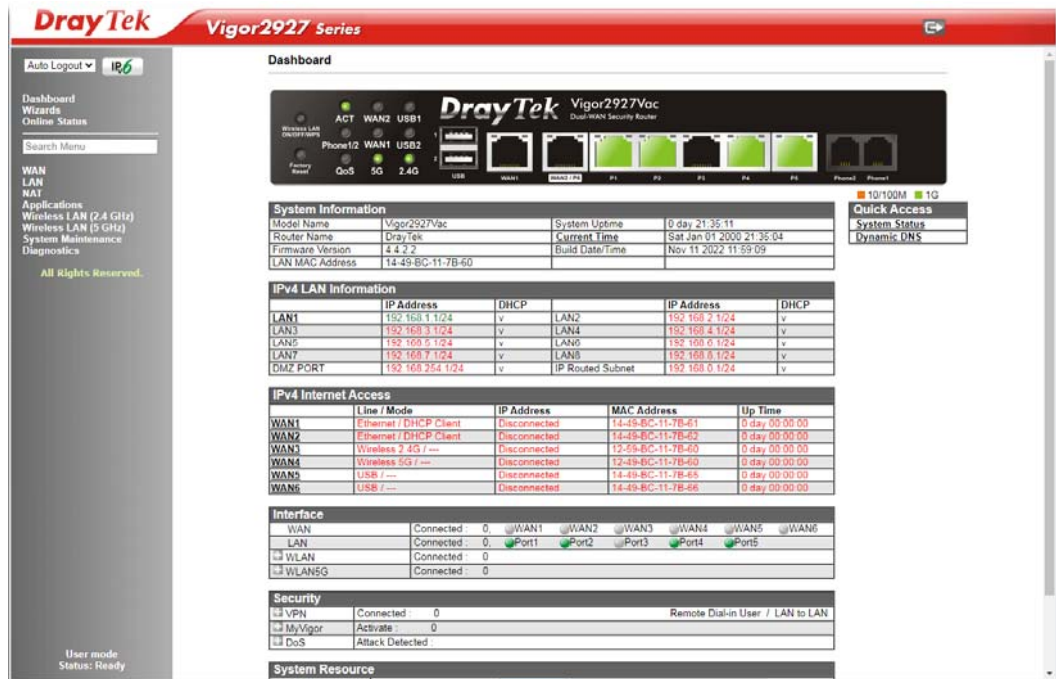

Only basic settings are available in User Mode. These are a subset of the Admin Mode settings.



Info

Setting in User Mode can be configured as same as in Admin Mode.

## VII-1-6 Login Page Greeting

When you want to access into the web user interface of Vigor router, the system will ask you to offer username and password first. At that moment, the background of the web page is blank and no heading will be displayed on the Login window. This page allows you to specify login URL and the heading on the Login window if you have such requirement.

This section allows you to customize the login page by adding a message and/or setting the page title.

System Maintenance >> Login Page Greeting

**Login Page Greeting**

Login Page Logo: Default ▼

(Max 524 × 352 pixel)

選擇檔案 未選擇任何檔案

Upload

Enable Greeting

Login Page Title: Router Login

Welcome Message and Bulletin (Max 511 characters) [Preview](#) [Set to Factory Default](#)

```

<h1><b><font color=red>Welcome Message</font></b></h1><p>This welcome message is
displayed in the Login page of the router. Replace this text with your own
message. </p><ol><li>The welcome message can be written in HTML so lists such as
this one can be created </li><li>Other markup tags such as p, font or img can be
used</li></ol>
        
```

Examples of Welcome Message and Bulletin:  
<h1><b><font color=red>Welcome Message</font></b></h1>  
<p>Message</p>

OK Cancel

Available settings are explained as follows:

| Item                         | Description                                                                                                                                                                                                                                                                                            |
|------------------------------|--------------------------------------------------------------------------------------------------------------------------------------------------------------------------------------------------------------------------------------------------------------------------------------------------------|
| Login Page Logo              | Set an image which will be shown above the log in window.<br>Default - The Enable Greeting feature is available to set the login page title.<br>Blank - No image / no greeting.<br>Upload a file - Choose an image file and click Upload. Later the selected image will be shown on the log in window. |
| Enable Greeting              | Check this box to enable the login customization function.                                                                                                                                                                                                                                             |
| Login Page Title             | Enter a brief description (e.g., Welcome to DrayTek) which will be shown on the heading of the login dialog.                                                                                                                                                                                           |
| Welcome Message and Bulletin | Enter words or sentences here. It will be displayed for bulletin message. In addition, it can be displayed on the login dialog at the bottom.<br>Note that do not enter URL redirect link here.                                                                                                        |
| Preview                      | Click to preview the customized login window based on the settings entered on this page.                                                                                                                                                                                                               |
| Set to Factory Default       | Click to return to the factory default setting.                                                                                                                                                                                                                                                        |



Below shows an example of a customized login page with the values entered in the Login Page Title and Welcome Message and Bulletin fields.



**DrayTek** Vigor2927 Series

**Login**

**Router Login**

**Username**

**Password**

The username or password you entered is incorrect.

**Login**

**Security Warning: You are logging in without encryption which is not recommended. To login securely [click here](#).**

Copyright © 2000-2020 DrayTek Corp. All Rights Reserved.

## Welcome Message

This welcome message is displayed in the Login page of the router. Replace this text with your own message.

1. The welcome message can be written in HTML so lists such as this one can be created
2. Other markup tags such as p, font or img can be used

## VII-1-7 Configuration Backup

This function allows the backup and restoration of router settings. In addition to restoring Vigor2927's own configuration backup, it is possible to restore backups from certain DrayTek routers such as Vigor2820, Vigor2830 and Vigor2850 series on the Vigor2927.

### Backing up the Configuration

Follow the steps below to backup your configuration.

1. Go to System Maintenance >> Configuration Backup. The following page will be shown.

System Maintenance >> Configuration Backup

---

Configuration Backup / Restoration

**Restore**  
Restore settings from a configuration file.

選擇檔案 未選擇任何檔案

USB Storage  

Restore configuration except the login password.

**Note:**  
This will work only if the selected configuration file was created from this device.

---

**Backup**  
Back up the current settings into a configuration file.

Protect with password

**Note:**  
The router's certificates are not part of the configuration file. Please use [Certificate Management >> Certificate Backup](#) for backup.

---

**Auto Backup to USB storage**

Enable

Backup folder  

Periodic backup  
Cycle duration:  days and  hours

Backup after change configuration

**Note:**

1. When loading a configuration file from a model in the Supported Model List please note that features and functionality can vary between models so please manually verify the settings after the restoration.
2. Auto backup to USB: if settings do not change, configuration doesn't backup.
3. Auto backup to USB: if configuration backup multiple times in one hour, the old file will be overwritten with the same filename.

**Supported Model List**

| Model     | Firmware Version  |
|-----------|-------------------|
| Vigor2926 | 3.9.1.4, or later |

Available settings are explained as follows:

| Item    | Description                                                                                                                                                                                                                                                                                                                                                                                        |
|---------|----------------------------------------------------------------------------------------------------------------------------------------------------------------------------------------------------------------------------------------------------------------------------------------------------------------------------------------------------------------------------------------------------|
| Restore | Restore settings from a configuration file - Click the Select File button to specify a file to be restored or click USB Storage (if a USB storage disk connected) to choose the configuration file.<br>Restore configuration except the login password - Select to exclude the password from getting restored from the backup.<br>Restore - Click to initiate restoration of configuration. If the |

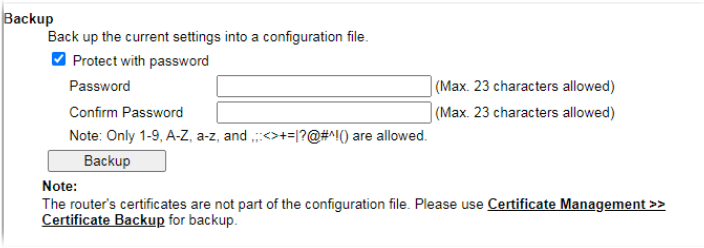
|                            |                                                                                                                                                                                                                                                                                                                                                                                                                                                                                                                                                      |
|----------------------------|------------------------------------------------------------------------------------------------------------------------------------------------------------------------------------------------------------------------------------------------------------------------------------------------------------------------------------------------------------------------------------------------------------------------------------------------------------------------------------------------------------------------------------------------------|
|                            | backup file is encrypted, you will be asked to enter the password.                                                                                                                                                                                                                                                                                                                                                                                                                                                                                   |
| Backup                     | <p>Click it to perform the configuration backup of this router. Protect with password- Select to encrypt the backup with a password. You will be prompted to enter the password as shown below:</p>  <ul style="list-style-type: none"> <li>● Password - Enter a new password for encrypting the configuration file.</li> <li>● Confirm Password - Enter the new password again for confirmation.</li> </ul> <p>Backup - Click to initiate the backup process.</p> |
| Auto Backup to USB storage | <p>The configuration can be stored to a USB connecting to Vigor router as a backup.</p> <p>Enable - Check the box to enable the function.</p> <p>Backup folder - Set the path for downloading.</p> <p>Periodic backup - Set the circle duration for backup.</p> <p>Backup after change configuration - Backup will be executed whenever the configuration is changed.</p>                                                                                                                                                                            |

2. Click the Backup button, and the File Download dialog will be shown. Depending on your browser, you may be prompted to select a location to save the file, or the file may be saved in the default download location of your browser. The configuration will download automatically to your computer as a file named config.cfg.

The above example is using Windows platform for demonstrating examples. The Mac or Linux platform will appear different windows, but the backup function is still available.



|      |                                                                                                                                                                           |
|------|---------------------------------------------------------------------------------------------------------------------------------------------------------------------------|
| Info | Configuration Backup does not include certificates stored on the router. Please back up certificates separately by going to Certificate Management >> Certificate Backup. |
|------|---------------------------------------------------------------------------------------------------------------------------------------------------------------------------|

## Restoring the Configuration

1. Go to System Maintenance >> Configuration Backup. The following windows will be shown.

Configuration Backup / Restoration

**Restore**

Restore settings from a configuration file.

選擇檔案 未選擇任何檔案  
 USB Storage    
 Restore configuration except the login password.

**Note:**  
This will work only if the selected configuration file was created from this device.

---

**Backup**

Back up the current settings into a configuration file.

Protect with password

**Note:**  
The router's certificates are not part of the configuration file. Please use [Certificate Management >> Certificate Backup](#) for backup.

---

**Auto Backup to USB storage**

Enable

Backup folder  

Periodic backup  
 Cycle duration:  days and  hours  
 Backup after change configuration

**Note:**

1. When loading a configuration file from a model in the Supported Model List please note that features and functionality can vary between models so please manually verify the settings after the restoration.
2. Auto backup to USB: if settings do not change, configuration doesn't backup.
3. Auto backup to USB: if configuration backup multiple times in one hour, the old file will be overwritten with the same filename.

**Supported Model List**

| Model     | Firmware Version  |
|-----------|-------------------|
| Vigor2926 | 3.9.1.4, or later |

2. Click the Choose File button under Backup to bring up the open file dialog box to select the configuration file to be uploaded and restored.
3. Click the Restore button and wait for few seconds.

---

## VII-1-8 Webhook

Vigor router will send a report (webhook message) including WAN up, down, CPU usage, memory usage and etc. to a monitoring server periodically.

System Maintenance >> Webhook

---

Enable

Monitoring Server URL

Report Period  
(1~1440 minutes)

OK

Cancel

**Note:**

Vigor Router will use HTTPS to send the Webhook message by default. When the Monitoring Server supports HTTP only, please configure the URL with HTTP://.

Available settings are explained as follows:

| Item                  | Description                                          |
|-----------------------|------------------------------------------------------|
| Enable                | Select it to enable this function.                   |
| Monitoring Server URL | Enter the URL of a server.                           |
| Report Period         | Define the interval time for each report to be sent. |

Select OK to save changes on the page.

## VII-1-9 Syslog/Mail Alert

SysLog function is provided for users to monitor router.

System Maintenance >> SysLog / Mail Alert Setup

**SysLog / Mail Alert Setup**

|                                                                                                                                                                                                                                                                                                                                                                                                                                                                                                                                                                                                                                                                                                                                                                                                                                                                                                                                                                                                                                                                                                                                                                                                                                                      |                                                                                                                                                                                                                                                                                                                                                                                                                                                                                                                                                                                                                                                                                                                                                                                                                                               |
|------------------------------------------------------------------------------------------------------------------------------------------------------------------------------------------------------------------------------------------------------------------------------------------------------------------------------------------------------------------------------------------------------------------------------------------------------------------------------------------------------------------------------------------------------------------------------------------------------------------------------------------------------------------------------------------------------------------------------------------------------------------------------------------------------------------------------------------------------------------------------------------------------------------------------------------------------------------------------------------------------------------------------------------------------------------------------------------------------------------------------------------------------------------------------------------------------------------------------------------------------|-----------------------------------------------------------------------------------------------------------------------------------------------------------------------------------------------------------------------------------------------------------------------------------------------------------------------------------------------------------------------------------------------------------------------------------------------------------------------------------------------------------------------------------------------------------------------------------------------------------------------------------------------------------------------------------------------------------------------------------------------------------------------------------------------------------------------------------------------|
| <p><b>SysLog Access Setup</b></p> <p><input checked="" type="checkbox"/> Enable</p> <p>Syslog Save to:</p> <p><input checked="" type="checkbox"/> Syslog Server</p> <p><input type="checkbox"/> USB Disk</p> <p>Maximum Syslog folder space: <input type="text" value="1"/> GB</p> <p>When Syslog folder is full: <input type="text" value="Overwrite oldest logs"/></p> <p><b>Router Name</b> <input type="text" value="DrayTek"/></p> <p><b>Primary Syslog Server</b></p> <p>Server IP/Hostname: <input type="text"/></p> <p>Destination Port: <input type="text" value="514"/></p> <p><b>Secondary Syslog Server</b></p> <p>Server IP/Hostname: <input type="text"/></p> <p>Destination Port: <input type="text" value="514"/></p> <p>Mail Syslog <input type="checkbox"/> Enable</p> <p>Enable syslog message:</p> <p><input checked="" type="checkbox"/> Firewall Log</p> <p><input checked="" type="checkbox"/> VPN Log</p> <p><input checked="" type="checkbox"/> User Access Log / Hotspot User Information</p> <p><input checked="" type="checkbox"/> Call Log</p> <p><input checked="" type="checkbox"/> WAN Log</p> <p><input checked="" type="checkbox"/> Router/DSL information</p> <p><input checked="" type="checkbox"/> WLAN Log</p> | <p><b>Mail Alert Setup</b></p> <p><input checked="" type="checkbox"/> Enable <input type="button" value="Send a test e-mail"/></p> <p>Interface: <input type="text" value="Any"/></p> <p>SMTP Server: <input type="text"/></p> <p>SMTP Port: <input type="text" value="25"/></p> <p>Mail To: <input type="text"/></p> <p>Sender Address: <input type="text"/></p> <p>Connection Security: <input type="text" value="Plaintext"/></p> <p><input type="checkbox"/> Authentication</p> <p>Username: <input type="text"/></p> <p>Password: <input type="text"/></p> <p>Enable E-Mail Alert:</p> <p><input checked="" type="checkbox"/> DoS Attack</p> <p><input checked="" type="checkbox"/> APPE</p> <p><input checked="" type="checkbox"/> VPN LOG</p> <p><input type="checkbox"/> APPE Signature</p> <p><input type="checkbox"/> Debug Log</p> |
|------------------------------------------------------------------------------------------------------------------------------------------------------------------------------------------------------------------------------------------------------------------------------------------------------------------------------------------------------------------------------------------------------------------------------------------------------------------------------------------------------------------------------------------------------------------------------------------------------------------------------------------------------------------------------------------------------------------------------------------------------------------------------------------------------------------------------------------------------------------------------------------------------------------------------------------------------------------------------------------------------------------------------------------------------------------------------------------------------------------------------------------------------------------------------------------------------------------------------------------------------|-----------------------------------------------------------------------------------------------------------------------------------------------------------------------------------------------------------------------------------------------------------------------------------------------------------------------------------------------------------------------------------------------------------------------------------------------------------------------------------------------------------------------------------------------------------------------------------------------------------------------------------------------------------------------------------------------------------------------------------------------------------------------------------------------------------------------------------------------|

**Note:**

1. USB Syslog space is available from 256-1024 MB or 1-16 GB.
2. Mail Syslog cannot be activated unless USB Disk is ticked for "Syslog Save to".
3. Mail Syslog feature will send the Syslog when it is full.

Available settings are explained as follows:

| Item                | Description                                                                                                                                                                                                                                                                                                                                                                                                                                                                                                                                  |
|---------------------|----------------------------------------------------------------------------------------------------------------------------------------------------------------------------------------------------------------------------------------------------------------------------------------------------------------------------------------------------------------------------------------------------------------------------------------------------------------------------------------------------------------------------------------------|
| SysLog Access Setup | <p>Enable - Select to enable the Syslog function.</p> <p>Syslog Save to - Check Syslog Server and / or USB Disk.</p> <ul style="list-style-type: none"> <li>● Syslog Server - Events will be sent to a Syslog server.</li> <li>● USB Disk - Events will be saved to a USB storage device connected to the router.</li> <li>● Maximum Syslog folder space - Set a space (unit GB/MB) to store event logs.</li> <li>● When Syslog folder is full - Specify the action (overwrite the olderest logs or stop logging) to be executed.</li> </ul> |
| Router Name         | <p>Shows the name of the router set in System Maintenance &gt;&gt; Management. This name will be used to identify the router in the Syslog entries.</p> <p>To set or modify the router name, click the hyperlink and you will be taken to System Maintenance &gt;&gt; Management where</p>                                                                                                                                                                                                                                                   |

|                                                    |                                                                                                                                                                                                                                                                                                                                                                                                                                                                                                                                                                                                                                                                                                                                                                                                                                                                                                                                                                                                                                                                                                                                                                                                                                                                                              |
|----------------------------------------------------|----------------------------------------------------------------------------------------------------------------------------------------------------------------------------------------------------------------------------------------------------------------------------------------------------------------------------------------------------------------------------------------------------------------------------------------------------------------------------------------------------------------------------------------------------------------------------------------------------------------------------------------------------------------------------------------------------------------------------------------------------------------------------------------------------------------------------------------------------------------------------------------------------------------------------------------------------------------------------------------------------------------------------------------------------------------------------------------------------------------------------------------------------------------------------------------------------------------------------------------------------------------------------------------------|
|                                                    | you can enter the value.                                                                                                                                                                                                                                                                                                                                                                                                                                                                                                                                                                                                                                                                                                                                                                                                                                                                                                                                                                                                                                                                                                                                                                                                                                                                     |
| Primary Syslog Server /<br>Secondary Syslog Server | <p>Primary Syslog Server / Secondary Syslog Server - Vigor router will send the data to Syslog server for analysis based on the server settings configured here. It might send to both servers simultaneously if primary and secondary servers are set; or send to either one of the servers which has been set here.</p> <p>Server IP /Hostname -The IP address or the host name of the Syslog server.</p> <p>Destination Port - Assign a port for the Syslog protocol.</p> <p>Mail Syslog - Check the box to recode the mail event on Syslog.</p> <p>Enable syslog message - Check the box listed on this web page to send the corresponding message of firewall, VPN, User Access, Call, WAN, Router/DSL information to Syslog.</p>                                                                                                                                                                                                                                                                                                                                                                                                                                                                                                                                                       |
| Mail Alert Setup                                   | <p>Enable - Select to enable the Mail Alert.</p> <p>Send a test e-mail - Click to send a test email message using the settings below.</p> <p>Interface - Specify the WAN interface for a mail passing through.</p> <p>SMTP Server - Enter the address of the SMTP server used to send email.</p> <p>SMTP Port - Enter the port of the SMTP server. Default setting is 25.</p> <p>Mail To - Enter the email address of the recipient.</p> <p>Sender Address - Enter the email address of the sender.</p> <p>Connection Security - Select a method (Plaintext, SSL or StartTLS) to ensure the connection security. SSL means to use port 465 for SMTP server for some e-mail server uses https as the transmission method.</p> <ul style="list-style-type: none"> <li>● Accept using plain text if StartTLS connection failed.</li> <li>● Force StartTLS. Stop if StartTLS connection failed.</li> </ul> <p>Authentication - Select this checkbox and enter the username and password if the SMTP server requires authentication.</p> <ul style="list-style-type: none"> <li>● User Name - Enter the user name for authentication.</li> <li>● Password - Enter the password for authentication.</li> </ul> <p>Enable E-mail Alert - Select the event types that will trigger email alerts.</p> |

Select OK to save changes on the page, or Clear to reset all settings to factory defaults.

To view the Syslog message, please follow the steps below:

1. On the Syslog / Mail Alert Setup screen, enter the monitor PC's IP address in the Server IP Address field.
2. Install the Router Tools from DrayTek web site. After installation, start Syslog by clicking on Router Tools>>Syslog in the Windows Start Menu.

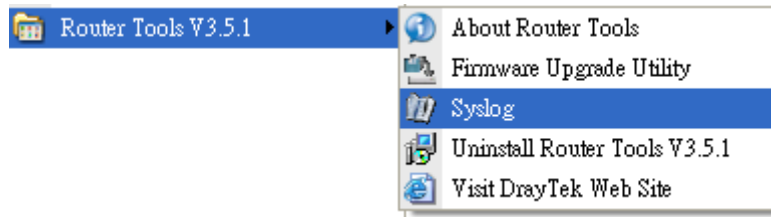

3. In the Syslog application, select the router you wish to monitor. Remember to select the network adapter to be used to connect to the router under Network Information, or else Syslog traffic cannot be received from the router.

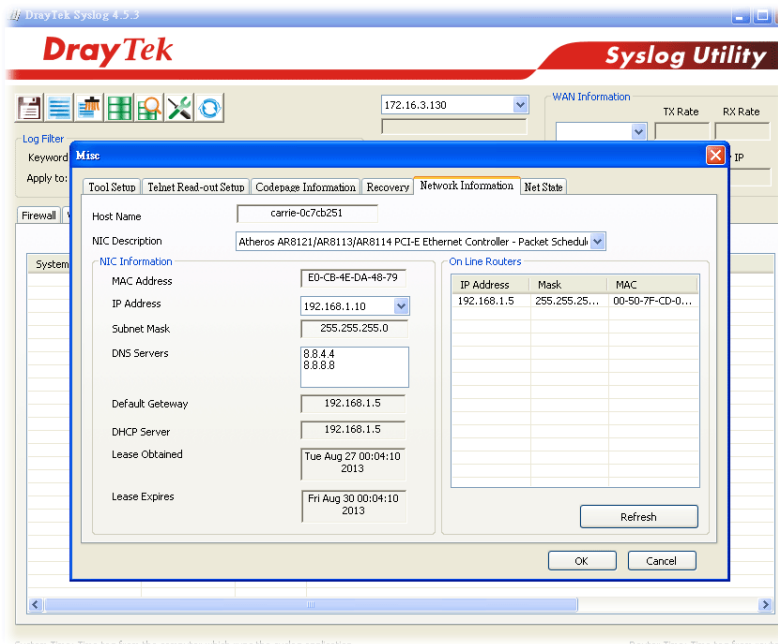



## VII-1-10 Time and Date

This section allows you to configure settings related to the system date and time.

System Maintenance >> Time and Date

**Time Information**

Current System Time: 2000 Jan 1 Sat 22 : 57 : 36 Inquire Time

---

**Time Setup**

Use Browser Time  
 Use Internet Time

Time Server:

Priority:

Time Zone:

Enable Daylight Saving:  Advanced

Automatically Update Interval:

Send NTP Request Through:

Available settings are explained as follows:

| Item                   | Description                                                                                                                                                                                                                                                                                                                                                                                                                                                                                                                                                                                                                                                                                                                                                                                                                                                                                                                                                                                                                                                                                                                                                                                                                                                                                                                                                                                                                 |
|------------------------|-----------------------------------------------------------------------------------------------------------------------------------------------------------------------------------------------------------------------------------------------------------------------------------------------------------------------------------------------------------------------------------------------------------------------------------------------------------------------------------------------------------------------------------------------------------------------------------------------------------------------------------------------------------------------------------------------------------------------------------------------------------------------------------------------------------------------------------------------------------------------------------------------------------------------------------------------------------------------------------------------------------------------------------------------------------------------------------------------------------------------------------------------------------------------------------------------------------------------------------------------------------------------------------------------------------------------------------------------------------------------------------------------------------------------------|
| Current System Time    | Click <b>Inquire Time</b> to retrieve the current time from the time server.                                                                                                                                                                                                                                                                                                                                                                                                                                                                                                                                                                                                                                                                                                                                                                                                                                                                                                                                                                                                                                                                                                                                                                                                                                                                                                                                                |
| Use Browser Time       | Select this option to let the router set its system time using the time reported by the web browser.                                                                                                                                                                                                                                                                                                                                                                                                                                                                                                                                                                                                                                                                                                                                                                                                                                                                                                                                                                                                                                                                                                                                                                                                                                                                                                                        |
| Use Internet Time      | Select this option to let the browser set its system time by retrieving time information from the specified network time server using the Network Time Protocol (NTP).                                                                                                                                                                                                                                                                                                                                                                                                                                                                                                                                                                                                                                                                                                                                                                                                                                                                                                                                                                                                                                                                                                                                                                                                                                                      |
| Time Server            | Enter the address of the time server.                                                                                                                                                                                                                                                                                                                                                                                                                                                                                                                                                                                                                                                                                                                                                                                                                                                                                                                                                                                                                                                                                                                                                                                                                                                                                                                                                                                       |
| Priority               | Select <b>Auto</b> or <b>IPv6 First</b> as the priority.                                                                                                                                                                                                                                                                                                                                                                                                                                                                                                                                                                                                                                                                                                                                                                                                                                                                                                                                                                                                                                                                                                                                                                                                                                                                                                                                                                    |
| Time Zone              | Select the time zone where the router is located.                                                                                                                                                                                                                                                                                                                                                                                                                                                                                                                                                                                                                                                                                                                                                                                                                                                                                                                                                                                                                                                                                                                                                                                                                                                                                                                                                                           |
| Enable Daylight Saving | <p>Check the box to enable Daylight Saving Time (DST) if it is applicable to your location.</p> <p><b>Advanced</b> - Click to enter a custom schedule to enable DST.</p> <div style="border: 1px solid black; padding: 5px; margin: 5px 0;"> <p><b>Daylight Saving Advanced</b></p> <p><input checked="" type="radio"/> <b>Default</b><br/>           Start: Last Sunday in March<br/>           End: Last Sunday in October</p> <p><input type="radio"/> <b>Customized: By Date</b><br/>           Start: <input type="text" value="Month"/> <input type="text" value="Day"/> <input type="text" value="00:00"/><br/>           End: <input type="text" value="Month"/> <input type="text" value="Day"/> <input type="text" value="00:00"/></p> <p><input type="radio"/> <b>Customized: By Weekday</b><br/>           Start: <input type="text" value="January"/> <input type="text" value="First"/> <input type="text" value="Sunday"/> <input type="text" value="00:00"/><br/>           End: <input type="text" value="January"/> <input type="text" value="First"/> <input type="text" value="Sunday"/> <input type="text" value="00:00"/></p> <p style="text-align: center;"> <input type="button" value="OK"/> <input type="button" value="Close"/> </p> </div> <p>Use the default time setting or set user defined time for your requirement.</p> <p>Default - Uses the default DST schedule for the time zone.</p> |

|                               |                                                                                                                                                                      |
|-------------------------------|----------------------------------------------------------------------------------------------------------------------------------------------------------------------|
|                               | <p>Date Range - Select this option if DST starts and ends on fixed dates.</p> <p>Yearly - Select this option if DST starts and ends on certain days of the week.</p> |
| Automatically Update Interval | Select the time interval at which the router updates the system time.                                                                                                |
| Send NTP Request Through      | Specify a WAN interface to send NTP request for time synchronization.                                                                                                |

Select OK to save changes on the page, or Cancel to discard changes without saving.

## VII-1-11 SNMP

This section allows you to configure settings for SNMP and SNMPv3 services.

The SNMPv3 is more secure than SNMP through the use of encryption (supports AES and DES) and authentication (supports MD5 and SHA) for the management needs.

System Maintenance >> SNMP

**SNMP Setup**

Enable SNMP Agent  
 Enable SNMPv3 Agent  
 Enable SNMPv2C Agent

Get Community:

Set Community:

Manager Host IP(IPv4)

| Index | IP                   | Subnet Mask          |
|-------|----------------------|----------------------|
| 1     | <input type="text"/> | <input type="text"/> |
| 2     | <input type="text"/> | <input type="text"/> |
| 3     | <input type="text"/> | <input type="text"/> |

Manager Host IP(IPv6)

| Index | IPv6 Address         | / Prefix Length                |
|-------|----------------------|--------------------------------|
| 1     | <input type="text"/> | <input type="text" value="0"/> |
| 2     | <input type="text"/> | <input type="text" value="0"/> |
| 3     | <input type="text"/> | <input type="text" value="0"/> |

Trap Community:

Notification Host IP(IPv4)

| Index | IP                   |
|-------|----------------------|
| 1     | <input type="text"/> |
| 2     | <input type="text"/> |

Notification Host IP(IPv6)

| Index | IPv6 Address         |
|-------|----------------------|
| 1     | <input type="text"/> |
| 2     | <input type="text"/> |

Trap Timeout:

Enable SNMPv1 Agent

Note:

SNMP service also shall be enabled for Internet access in **System Maintenance >> Management**.

OK Cancel

Available settings are explained as follows:

| Item              | Description                                                                                                                                                              |
|-------------------|--------------------------------------------------------------------------------------------------------------------------------------------------------------------------|
| Enable SNMP Agent | Check to enable SNMP function. Then, enable SNMPv3 Agent / SNMPv2C Agent/ SNMPv1 Agent.                                                                                  |
| Get Community     | Enter the Get Community string. The default setting is public. Devices that send requests to retrieve information using get commands must pass the correct Get Community |

|                             |                                                                                                                                                                                                                               |
|-----------------------------|-------------------------------------------------------------------------------------------------------------------------------------------------------------------------------------------------------------------------------|
|                             | string.<br>The maximum allowed length is 23 characters.                                                                                                                                                                       |
| Set Community               | Enter the Set Community string. The default setting is private. Devices that send requests to change settings using set commands must pass the correct Set Community string. The maximum length of the text is 23 characters. |
| Manager Host IP (IPv4)      | Enter the IPv4 address of hosts that are allowed to issue SNMP commands. If this field is left blank, any IPv4 LAN host is allowed to issue SNMP commands.                                                                    |
| Manager Host IP (IPv6)      | Enter the IPv6 address of hosts that are allowed to issue SNMP commands. If this field is left blank, any IPv6 LAN host is allowed to issue SNMP commands.                                                                    |
| Trap Community              | Enter the Trap Community string. The default setting is public. Devices that send unsolicited messages to the SNMP console must pass the correct Trap Community string. The maximum length of the text is 23 characters.      |
| Notification Host IP (IPv4) | Enter the IPv4 address of hosts that are allowed to be sent SNMP traps.                                                                                                                                                       |
| Notification Host IP (IPv6) | Enter the IPv6 address of hosts that are allowed to be sent SNMP traps.                                                                                                                                                       |
| Trap Timeout                | The default setting is 10 seconds.                                                                                                                                                                                            |
| Enable SNMPV3 Agent         | Check to enable SNMPV3 function.                                                                                                                                                                                              |
| USM User                    | USM means user-based security mode.<br>Enter the username to be used for authentication. The maximum allowed length is 23 characters.                                                                                         |
| Auth Algorithm              | Choose one of the hashing methods to be used with the authentication algorithm.                                                                                                                                               |
| Auth Password               | Enter a password for authentication. The maximum allowed length is 23 characters.                                                                                                                                             |
| Privacy Algorithm           | Choose an encryption method as the privacy algorithm.                                                                                                                                                                         |
| Privacy Password            | Enter a password for privacy. The maximum allowed length is 23 characters.                                                                                                                                                    |

Select OK to save changes on the page, or Cancel to discard changes without saving.

## VII-1-11 Management

This page allows you to manage the settings for Internet/LAN Access Control, Access List from Internet, Management Port Setup, TLS/SSL Encryption Setup, CVM Access Control and Device Management.

Management setup for IPv4 and IPv6 are on separate tab pages.

### IPv4 Management Setup

System Maintenance >> Management



| IPv4 Management Setup                                                                                                                                                                                                                                                                                                                                                                                                                                                                                                                                                                                                                                          | IPv6 Management Setup | LAN Access Setup |           |       |             |   |           |      |   |           |      |   |           |      |   |           |      |   |           |      |   |           |      |   |           |      |   |           |      |   |           |      |    |           |      |
|----------------------------------------------------------------------------------------------------------------------------------------------------------------------------------------------------------------------------------------------------------------------------------------------------------------------------------------------------------------------------------------------------------------------------------------------------------------------------------------------------------------------------------------------------------------------------------------------------------------------------------------------------------------|-----------------------|------------------|-----------|-------|-------------|---|-----------|------|---|-----------|------|---|-----------|------|---|-----------|------|---|-----------|------|---|-----------|------|---|-----------|------|---|-----------|------|---|-----------|------|----|-----------|------|
| Router Name <input type="text" value="DrayTek"/>                                                                                                                                                                                                                                                                                                                                                                                                                                                                                                                                                                                                               |                       |                  |           |       |             |   |           |      |   |           |      |   |           |      |   |           |      |   |           |      |   |           |      |   |           |      |   |           |      |   |           |      |    |           |      |
| <input type="checkbox"/> Default:Disable Auto-Logout<br><input type="checkbox"/> Enable Validation Code in Internet/LAN Access                                                                                                                                                                                                                                                                                                                                                                                                                                                                                                                                 |                       |                  |           |       |             |   |           |      |   |           |      |   |           |      |   |           |      |   |           |      |   |           |      |   |           |      |   |           |      |   |           |      |    |           |      |
| <b>Internet Access Control</b><br><input type="checkbox"/> Allow management from the Internet<br>Domain name allowed <input type="text"/> <ul style="list-style-type: none"> <li><input type="checkbox"/> FTP Server</li> <li><input type="checkbox"/> HTTP Server <input checked="" type="checkbox"/> Enforce HTTPS Access</li> <li><input checked="" type="checkbox"/> HTTPS Server</li> <li><input type="checkbox"/> Telnet Server</li> <li><input type="checkbox"/> TR069 Server</li> <li><input type="checkbox"/> SSH Server</li> <li><input type="checkbox"/> SNMP Server</li> </ul> <input checked="" type="checkbox"/> Disable PING from the Internet  |                       |                  |           |       |             |   |           |      |   |           |      |   |           |      |   |           |      |   |           |      |   |           |      |   |           |      |   |           |      |   |           |      |    |           |      |
| <b>Apply to Interface</b><br><input type="text" value="Selected Interface"/>                                                                                                                                                                                                                                                                                                                                                                                                                                                                                                                                                                                   |                       |                  |           |       |             |   |           |      |   |           |      |   |           |      |   |           |      |   |           |      |   |           |      |   |           |      |   |           |      |   |           |      |    |           |      |
| <b>Loopback Interface</b><br><input type="checkbox"/> Enable Loopback Interface <input type="text" value="LAN1"/>                                                                                                                                                                                                                                                                                                                                                                                                                                                                                                                                              |                       |                  |           |       |             |   |           |      |   |           |      |   |           |      |   |           |      |   |           |      |   |           |      |   |           |      |   |           |      |   |           |      |    |           |      |
| <b>Note:</b><br>1. Management from WAN only available using Loopback IP, the WAN IP will not respond.<br>2. Source IP used for TR069,NTP,RADIUS/TACACS+,SYSLOG,SNMP.                                                                                                                                                                                                                                                                                                                                                                                                                                                                                           |                       |                  |           |       |             |   |           |      |   |           |      |   |           |      |   |           |      |   |           |      |   |           |      |   |           |      |   |           |      |   |           |      |    |           |      |
| <b>Access List from the Internet</b><br><input type="checkbox"/> Apply Access List to PING                                                                                                                                                                                                                                                                                                                                                                                                                                                                                                                                                                     |                       |                  |           |       |             |   |           |      |   |           |      |   |           |      |   |           |      |   |           |      |   |           |      |   |           |      |   |           |      |   |           |      |    |           |      |
| <table border="1"> <thead> <tr> <th>List Type</th> <th>Index</th> <th>Description</th> </tr> </thead> <tbody> <tr><td>1</td><td>IP Object</td><td>None</td></tr> <tr><td>2</td><td>IP Object</td><td>None</td></tr> <tr><td>3</td><td>IP Object</td><td>None</td></tr> <tr><td>4</td><td>IP Object</td><td>None</td></tr> <tr><td>5</td><td>IP Object</td><td>None</td></tr> <tr><td>6</td><td>IP Object</td><td>None</td></tr> <tr><td>7</td><td>IP Object</td><td>None</td></tr> <tr><td>8</td><td>IP Object</td><td>None</td></tr> <tr><td>9</td><td>IP Object</td><td>None</td></tr> <tr><td>10</td><td>IP Object</td><td>None</td></tr> </tbody> </table> |                       |                  | List Type | Index | Description | 1 | IP Object | None | 2 | IP Object | None | 3 | IP Object | None | 4 | IP Object | None | 5 | IP Object | None | 6 | IP Object | None | 7 | IP Object | None | 8 | IP Object | None | 9 | IP Object | None | 10 | IP Object | None |
| List Type                                                                                                                                                                                                                                                                                                                                                                                                                                                                                                                                                                                                                                                      | Index                 | Description      |           |       |             |   |           |      |   |           |      |   |           |      |   |           |      |   |           |      |   |           |      |   |           |      |   |           |      |   |           |      |    |           |      |
| 1                                                                                                                                                                                                                                                                                                                                                                                                                                                                                                                                                                                                                                                              | IP Object             | None             |           |       |             |   |           |      |   |           |      |   |           |      |   |           |      |   |           |      |   |           |      |   |           |      |   |           |      |   |           |      |    |           |      |
| 2                                                                                                                                                                                                                                                                                                                                                                                                                                                                                                                                                                                                                                                              | IP Object             | None             |           |       |             |   |           |      |   |           |      |   |           |      |   |           |      |   |           |      |   |           |      |   |           |      |   |           |      |   |           |      |    |           |      |
| 3                                                                                                                                                                                                                                                                                                                                                                                                                                                                                                                                                                                                                                                              | IP Object             | None             |           |       |             |   |           |      |   |           |      |   |           |      |   |           |      |   |           |      |   |           |      |   |           |      |   |           |      |   |           |      |    |           |      |
| 4                                                                                                                                                                                                                                                                                                                                                                                                                                                                                                                                                                                                                                                              | IP Object             | None             |           |       |             |   |           |      |   |           |      |   |           |      |   |           |      |   |           |      |   |           |      |   |           |      |   |           |      |   |           |      |    |           |      |
| 5                                                                                                                                                                                                                                                                                                                                                                                                                                                                                                                                                                                                                                                              | IP Object             | None             |           |       |             |   |           |      |   |           |      |   |           |      |   |           |      |   |           |      |   |           |      |   |           |      |   |           |      |   |           |      |    |           |      |
| 6                                                                                                                                                                                                                                                                                                                                                                                                                                                                                                                                                                                                                                                              | IP Object             | None             |           |       |             |   |           |      |   |           |      |   |           |      |   |           |      |   |           |      |   |           |      |   |           |      |   |           |      |   |           |      |    |           |      |
| 7                                                                                                                                                                                                                                                                                                                                                                                                                                                                                                                                                                                                                                                              | IP Object             | None             |           |       |             |   |           |      |   |           |      |   |           |      |   |           |      |   |           |      |   |           |      |   |           |      |   |           |      |   |           |      |    |           |      |
| 8                                                                                                                                                                                                                                                                                                                                                                                                                                                                                                                                                                                                                                                              | IP Object             | None             |           |       |             |   |           |      |   |           |      |   |           |      |   |           |      |   |           |      |   |           |      |   |           |      |   |           |      |   |           |      |    |           |      |
| 9                                                                                                                                                                                                                                                                                                                                                                                                                                                                                                                                                                                                                                                              | IP Object             | None             |           |       |             |   |           |      |   |           |      |   |           |      |   |           |      |   |           |      |   |           |      |   |           |      |   |           |      |   |           |      |    |           |      |
| 10                                                                                                                                                                                                                                                                                                                                                                                                                                                                                                                                                                                                                                                             | IP Object             | None             |           |       |             |   |           |      |   |           |      |   |           |      |   |           |      |   |           |      |   |           |      |   |           |      |   |           |      |   |           |      |    |           |      |
| <b>Note:</b><br>Access list type: Hostname, single IP address supported for corresponding domain name.                                                                                                                                                                                                                                                                                                                                                                                                                                                                                                                                                         |                       |                  |           |       |             |   |           |      |   |           |      |   |           |      |   |           |      |   |           |      |   |           |      |   |           |      |   |           |      |   |           |      |    |           |      |
| <b>Management Port Setup</b><br><input checked="" type="radio"/> User Define Ports <input type="radio"/> Default Ports                                                                                                                                                                                                                                                                                                                                                                                                                                                                                                                                         |                       |                  |           |       |             |   |           |      |   |           |      |   |           |      |   |           |      |   |           |      |   |           |      |   |           |      |   |           |      |   |           |      |    |           |      |
| Telnet Port <input type="text" value="23"/> (Default: 23)<br>HTTP Port <input type="text" value="80"/> (Default: 80)<br>HTTPS Port <input type="text" value="443"/> (Default: 443)<br>FTP Port <input type="text" value="21"/> (Default: 21)<br>TR069 Port <input type="text" value="8069"/> (Default: 8069)<br>SSH Port <input type="text" value="22"/> (Default: 22)                                                                                                                                                                                                                                                                                         |                       |                  |           |       |             |   |           |      |   |           |      |   |           |      |   |           |      |   |           |      |   |           |      |   |           |      |   |           |      |   |           |      |    |           |      |
| <b>Note:</b><br>Ports 8001 and 8043 are used for Hotspot Web Portal.                                                                                                                                                                                                                                                                                                                                                                                                                                                                                                                                                                                           |                       |                  |           |       |             |   |           |      |   |           |      |   |           |      |   |           |      |   |           |      |   |           |      |   |           |      |   |           |      |   |           |      |    |           |      |
| <b>Brute Force Protection</b><br><input checked="" type="checkbox"/> Enable brute force login protection                                                                                                                                                                                                                                                                                                                                                                                                                                                                                                                                                       |                       |                  |           |       |             |   |           |      |   |           |      |   |           |      |   |           |      |   |           |      |   |           |      |   |           |      |   |           |      |   |           |      |    |           |      |
| <input checked="" type="checkbox"/> FTP Server<br><input checked="" type="checkbox"/> HTTP Server<br><input checked="" type="checkbox"/> HTTPS Server<br><input checked="" type="checkbox"/> Telnet Server<br><input checked="" type="checkbox"/> TR069 Server<br><input checked="" type="checkbox"/> SSH Server<br><input checked="" type="checkbox"/> VPN Server                                                                                                                                                                                                                                                                                             |                       |                  |           |       |             |   |           |      |   |           |      |   |           |      |   |           |      |   |           |      |   |           |      |   |           |      |   |           |      |   |           |      |    |           |      |
| Maximum login failures <input type="text" value="5"/> times<br>Penalty period <input type="text" value="300"/> seconds                                                                                                                                                                                                                                                                                                                                                                                                                                                                                                                                         |                       |                  |           |       |             |   |           |      |   |           |      |   |           |      |   |           |      |   |           |      |   |           |      |   |           |      |   |           |      |   |           |      |    |           |      |
| <b>Blocked IP List</b>                                                                                                                                                                                                                                                                                                                                                                                                                                                                                                                                                                                                                                         |                       |                  |           |       |             |   |           |      |   |           |      |   |           |      |   |           |      |   |           |      |   |           |      |   |           |      |   |           |      |   |           |      |    |           |      |
| <b>TLS/SSL Encryption Setup</b><br><input checked="" type="checkbox"/> Enable TLS 1.3<br><input checked="" type="checkbox"/> Enable TLS 1.2<br><input checked="" type="checkbox"/> Enable TLS 1.1<br><input checked="" type="checkbox"/> Enable TLS 1.0                                                                                                                                                                                                                                                                                                                                                                                                        |                       |                  |           |       |             |   |           |      |   |           |      |   |           |      |   |           |      |   |           |      |   |           |      |   |           |      |   |           |      |   |           |      |    |           |      |
| <b>CVM Access Control</b><br><input type="checkbox"/> CVM Port <input type="text" value="8000"/> (Default: 8000)<br><input type="checkbox"/> CVM SSL Port <input type="text" value="8443"/> (Default: 8443)                                                                                                                                                                                                                                                                                                                                                                                                                                                    |                       |                  |           |       |             |   |           |      |   |           |      |   |           |      |   |           |      |   |           |      |   |           |      |   |           |      |   |           |      |   |           |      |    |           |      |
| <b>AP Management</b><br><input checked="" type="checkbox"/> Enable AP Management                                                                                                                                                                                                                                                                                                                                                                                                                                                                                                                                                                               |                       |                  |           |       |             |   |           |      |   |           |      |   |           |      |   |           |      |   |           |      |   |           |      |   |           |      |   |           |      |   |           |      |    |           |      |
| <input checked="" type="checkbox"/> <b>Device Management</b><br><input type="checkbox"/> Respond to external device                                                                                                                                                                                                                                                                                                                                                                                                                                                                                                                                            |                       |                  |           |       |             |   |           |      |   |           |      |   |           |      |   |           |      |   |           |      |   |           |      |   |           |      |   |           |      |   |           |      |    |           |      |

OK

Available settings are explained as follows:

| Item        | Description                               |
|-------------|-------------------------------------------|
| Router Name | Enter the router name as provided by ISP. |

|                                                      |                                                                                                                                                                                                                                                                                                                                                                                                                                                                                                                                                                                                                                                                                                                                                                                                                                                                                                                                                                                                                                                                                                                                                                                                                                                |
|------------------------------------------------------|------------------------------------------------------------------------------------------------------------------------------------------------------------------------------------------------------------------------------------------------------------------------------------------------------------------------------------------------------------------------------------------------------------------------------------------------------------------------------------------------------------------------------------------------------------------------------------------------------------------------------------------------------------------------------------------------------------------------------------------------------------------------------------------------------------------------------------------------------------------------------------------------------------------------------------------------------------------------------------------------------------------------------------------------------------------------------------------------------------------------------------------------------------------------------------------------------------------------------------------------|
| <p>Default: Disable Auto-Logout</p>                  | <p>If enabled, the auto-logout function for web user interface will be disabled.</p>  <p>The web user interface will not terminate until you manually click the Logout icon.</p>                                                                                                                                                                                                                                                                                                                                                                                                                                                                                                                                                                                                                                                                                                                                                                                                                                                                                                                                                                             |
| <p>Enable Validation Code in Internet/LAN Access</p> | <p>If enabled, Vigor router will require users to enter a validation code as shown in an image when they log in.</p>                                                                                                                                                                                                                                                                                                                                                                                                                                                                                                                                                                                                                                                                                                                                                                                                                                                                                                                                                                                                                                                                                                                           |
| <p>Internet Access Control</p>                       | <p>Allow management from the Internet - Enable the checkbox to allow system administrators to login from the Internet, and then select the specific services that are allowed to be remotely administered.</p> <p>Domain name allowed - This setting is only available if DNS filtering is enabled, applying DNS filter profile in firewall rules, or enabling DNS Filter Local Setting. The router will only allow connections to the WebUI using domain addresses configured in either DDNS profiles or this section.</p> <p>If DNS filtering is disabled, this setting will be disabled, and any domain address that resolves to the router's WAN IP address can be used to connect to the WebUI.</p> <p>Disable PING from the Internet - Select to reject all PING packets from the Internet. For increased security, this setting is enabled by default.</p> <p>Apply to Interface - Allow the user to access the router via the selected WAN interfaces.</p>                                                                                                                                                                                                                                                                             |
| <p>Loopback Interface</p>                            | <p>A loopback interface is a logical virtual interface created on a router simulating a real interface. This can be used to connect to management services such as Web (HTTPS), SNMP, ACS (TR069), Syslog, or SSH as well as authentication services such as TACACS+ or RADIUS instead of using a LAN IP. For the authentication function, using the dedicated loopback address will reduce the administrative overhead since there is no need to add multiple router IP addresses to the AAA server. In addition, security will be enhanced by isolating authentication from the user network.</p> <p>Using a loopback address means the virtual interface is always up, especially when the CPE has multiple WAN interfaces. For example, if BGP connected on WAN1 is down, management and AAA traffic can be routed to the defined loopback interface through the VPN tunnel connected on WAN2.</p> <p>Another benefit is that the loopback IP can be an IP address (with a 32-bit mask). This means that the interface is not assigned to any LAN port, which improves security and saves a lot of IP address space. We can imagine that if we assign 24-bit mask IPs to many managed routers, there will be insufficient network IPs.</p> |

|                               |                                                                                                                                                                                                                                                                                                                                                                                                                                                                                                                                                                                                                                                                                                                                                                                                                                                                     |
|-------------------------------|---------------------------------------------------------------------------------------------------------------------------------------------------------------------------------------------------------------------------------------------------------------------------------------------------------------------------------------------------------------------------------------------------------------------------------------------------------------------------------------------------------------------------------------------------------------------------------------------------------------------------------------------------------------------------------------------------------------------------------------------------------------------------------------------------------------------------------------------------------------------|
|                               | <p>Enable Loopback Interface - Select to enable the function of Loopback Interface.</p> <p>LAN#- Select a LAN subnet as the Loopback Interface.</p>                                                                                                                                                                                                                                                                                                                                                                                                                                                                                                                                                                                                                                                                                                                 |
| Access List from the Internet | <p>The ability of system administrators to log into the router can be restricted to up to 10 specific hosts or networks.</p> <p>Apply Access List to PING - When this option is checked and Disable PING from the Internet is unchecked, pings originating from the Internet will be accepted only if they are from one of the IP addresses and/or subnet masks specified below. This option has no effect if Disable PING from the Internet is checked, which blocks all pings from the Internet.</p> <p>Type - Select IP Object.</p> <p>Index - Select the index number of a configured IP object.</p> <p>Description - Shows a brief comment for the selected IP object (with subnet mask).</p>                                                                                                                                                                  |
| Management Port Setup         | <p>User Define Ports - Check to specify user-defined port numbers for the Telnet, HTTP, HTTPS, FTP, TR-069 and SSH servers.</p> <p>Default Ports - Check to use standard port numbers for the servers.</p>                                                                                                                                                                                                                                                                                                                                                                                                                                                                                                                                                                                                                                                          |
| Brute Force Protection        | <p>Any client trying to access into Internet via Vigor router will be asked for passing through user authentication. Such feature can prevent Vigor router from attacks when a hacker tries every possible combination of letters, numbers and symbols until find out the correct combination of password.</p> <p>Enable brute force login protection - Select to enable detection of brute force login attempts.</p> <p>Maximum login failure - Specify the maximum number of failed login attempts before further login is blocked.</p> <p>Penalty period - Set the lockout time after maximum number of login attempts has been exceeded. The user will be unable to attempt to log in until the specified time has passed.</p> <p>Blocked IP List - Display, in a new browser window, IP addresses that are currently blocked from logging into the router.</p> |
| TLS/SSL Encryption Setup      | <p>Enable TLS 3.0/1.0/1.1/1.2/1.3 - Check the box to enable TLS 3.0/1.0/1.1/1.2/1.3 encryption protocols.</p> <p>For improved security, the HTTPS and SSL VPN servers that are built into the router have been upgraded to TLS 1.x protocol. If you are using an old web browser (eg. IE 6.0) or an old version of the SmartVPN Client, you may need to enable SSL 3.0 to connect to the router. However, it is recommended that you instead upgrade your web browser or SmartVPN client to a version that supports TLS protocols that are far more secure than SSL.</p>                                                                                                                                                                                                                                                                                            |
| CVM Access Control            | <p>CVM Port - Check the box to enable Central VPN Management port setting.</p> <p>CVM SSL Port - Check the box to enable Central VPN Management SSL port setting.</p>                                                                                                                                                                                                                                                                                                                                                                                                                                                                                                                                                                                                                                                                                               |
| AP Management                 | <p>Enable AP Management - Check to enable the access point management function. If not, menu items related to Central</p>                                                                                                                                                                                                                                                                                                                                                                                                                                                                                                                                                                                                                                                                                                                                           |

|                   |                                                                                                                                                                                                                                                                                                                                                      |
|-------------------|------------------------------------------------------------------------------------------------------------------------------------------------------------------------------------------------------------------------------------------------------------------------------------------------------------------------------------------------------|
|                   | Management>>AP will be hidden.                                                                                                                                                                                                                                                                                                                       |
| Device Management | Check to enable the device management function.<br>Respond to external device - If selected, Vigor2927 will function as a slave device. When an external device (master device) sends packets to the Vigor2927 to attempt to manage it, the Vigor2927 will respond to the request coming from the external device which is able to manage Vigor2927. |

Select OK to save changes on the page.

## IPv6 Management Setup

System Maintenance >> Management



| IPv4 Management Setup                                                                                                                                                                                                                                                                                                                                                                                                                                                                                                                                                                                                                                                                                                                                                                                                                                                                                                                                                                                                                                     | IPv6 Management Setup | LAN Access Setup |             |      |       |             |   |           |      |  |   |           |      |  |   |           |      |  |   |           |      |  |   |           |      |  |   |           |      |  |   |           |      |  |   |           |      |  |   |           |      |  |    |           |      |  |
|-----------------------------------------------------------------------------------------------------------------------------------------------------------------------------------------------------------------------------------------------------------------------------------------------------------------------------------------------------------------------------------------------------------------------------------------------------------------------------------------------------------------------------------------------------------------------------------------------------------------------------------------------------------------------------------------------------------------------------------------------------------------------------------------------------------------------------------------------------------------------------------------------------------------------------------------------------------------------------------------------------------------------------------------------------------|-----------------------|------------------|-------------|------|-------|-------------|---|-----------|------|--|---|-----------|------|--|---|-----------|------|--|---|-----------|------|--|---|-----------|------|--|---|-----------|------|--|---|-----------|------|--|---|-----------|------|--|---|-----------|------|--|----|-----------|------|--|
| <b>Management Access Control</b><br><input type="checkbox"/> Allow management from the Internet<br><input type="checkbox"/> Telnet Server ( Port : 23)<br><input type="checkbox"/> HTTP Server ( Port : 80) <input type="checkbox"/> Enforce HTTPS Access<br><input type="checkbox"/> HTTPS Server ( Port : 443)<br><input type="checkbox"/> SSH Server ( Port : 22)<br><input type="checkbox"/> SNMP Server ( Port : 161)<br><input checked="" type="checkbox"/> Disable PING from the Internet<br><b>IPv6 Address Security Option</b><br><input checked="" type="checkbox"/> Enable Random Interface Identifiers(IIDs) instead of EUI-64 IIDs                                                                                                                                                                                                                                                                                                                                                                                                           |                       |                  |             |      |       |             |   |           |      |  |   |           |      |  |   |           |      |  |   |           |      |  |   |           |      |  |   |           |      |  |   |           |      |  |   |           |      |  |   |           |      |  |    |           |      |  |
| <b>Access List from the Internet</b><br><input type="checkbox"/> Apply Access List to PING<br><table border="1"> <thead> <tr> <th>List</th> <th>Type</th> <th>Index</th> <th>Description</th> </tr> </thead> <tbody> <tr><td>1</td><td>IP Object</td><td>None</td><td></td></tr> <tr><td>2</td><td>IP Object</td><td>None</td><td></td></tr> <tr><td>3</td><td>IP Object</td><td>None</td><td></td></tr> <tr><td>4</td><td>IP Object</td><td>None</td><td></td></tr> <tr><td>5</td><td>IP Object</td><td>None</td><td></td></tr> <tr><td>6</td><td>IP Object</td><td>None</td><td></td></tr> <tr><td>7</td><td>IP Object</td><td>None</td><td></td></tr> <tr><td>8</td><td>IP Object</td><td>None</td><td></td></tr> <tr><td>9</td><td>IP Object</td><td>None</td><td></td></tr> <tr><td>10</td><td>IP Object</td><td>None</td><td></td></tr> </tbody> </table> <p><b>Note:</b><br/>           1Telnet / Http server port is the same as IPv4.<br/>           2Access list type: Hostname, single IP address supported for corresponding domain name.</p> |                       |                  | List        | Type | Index | Description | 1 | IP Object | None |  | 2 | IP Object | None |  | 3 | IP Object | None |  | 4 | IP Object | None |  | 5 | IP Object | None |  | 6 | IP Object | None |  | 7 | IP Object | None |  | 8 | IP Object | None |  | 9 | IP Object | None |  | 10 | IP Object | None |  |
| List                                                                                                                                                                                                                                                                                                                                                                                                                                                                                                                                                                                                                                                                                                                                                                                                                                                                                                                                                                                                                                                      | Type                  | Index            | Description |      |       |             |   |           |      |  |   |           |      |  |   |           |      |  |   |           |      |  |   |           |      |  |   |           |      |  |   |           |      |  |   |           |      |  |   |           |      |  |    |           |      |  |
| 1                                                                                                                                                                                                                                                                                                                                                                                                                                                                                                                                                                                                                                                                                                                                                                                                                                                                                                                                                                                                                                                         | IP Object             | None             |             |      |       |             |   |           |      |  |   |           |      |  |   |           |      |  |   |           |      |  |   |           |      |  |   |           |      |  |   |           |      |  |   |           |      |  |   |           |      |  |    |           |      |  |
| 2                                                                                                                                                                                                                                                                                                                                                                                                                                                                                                                                                                                                                                                                                                                                                                                                                                                                                                                                                                                                                                                         | IP Object             | None             |             |      |       |             |   |           |      |  |   |           |      |  |   |           |      |  |   |           |      |  |   |           |      |  |   |           |      |  |   |           |      |  |   |           |      |  |   |           |      |  |    |           |      |  |
| 3                                                                                                                                                                                                                                                                                                                                                                                                                                                                                                                                                                                                                                                                                                                                                                                                                                                                                                                                                                                                                                                         | IP Object             | None             |             |      |       |             |   |           |      |  |   |           |      |  |   |           |      |  |   |           |      |  |   |           |      |  |   |           |      |  |   |           |      |  |   |           |      |  |   |           |      |  |    |           |      |  |
| 4                                                                                                                                                                                                                                                                                                                                                                                                                                                                                                                                                                                                                                                                                                                                                                                                                                                                                                                                                                                                                                                         | IP Object             | None             |             |      |       |             |   |           |      |  |   |           |      |  |   |           |      |  |   |           |      |  |   |           |      |  |   |           |      |  |   |           |      |  |   |           |      |  |   |           |      |  |    |           |      |  |
| 5                                                                                                                                                                                                                                                                                                                                                                                                                                                                                                                                                                                                                                                                                                                                                                                                                                                                                                                                                                                                                                                         | IP Object             | None             |             |      |       |             |   |           |      |  |   |           |      |  |   |           |      |  |   |           |      |  |   |           |      |  |   |           |      |  |   |           |      |  |   |           |      |  |   |           |      |  |    |           |      |  |
| 6                                                                                                                                                                                                                                                                                                                                                                                                                                                                                                                                                                                                                                                                                                                                                                                                                                                                                                                                                                                                                                                         | IP Object             | None             |             |      |       |             |   |           |      |  |   |           |      |  |   |           |      |  |   |           |      |  |   |           |      |  |   |           |      |  |   |           |      |  |   |           |      |  |   |           |      |  |    |           |      |  |
| 7                                                                                                                                                                                                                                                                                                                                                                                                                                                                                                                                                                                                                                                                                                                                                                                                                                                                                                                                                                                                                                                         | IP Object             | None             |             |      |       |             |   |           |      |  |   |           |      |  |   |           |      |  |   |           |      |  |   |           |      |  |   |           |      |  |   |           |      |  |   |           |      |  |   |           |      |  |    |           |      |  |
| 8                                                                                                                                                                                                                                                                                                                                                                                                                                                                                                                                                                                                                                                                                                                                                                                                                                                                                                                                                                                                                                                         | IP Object             | None             |             |      |       |             |   |           |      |  |   |           |      |  |   |           |      |  |   |           |      |  |   |           |      |  |   |           |      |  |   |           |      |  |   |           |      |  |   |           |      |  |    |           |      |  |
| 9                                                                                                                                                                                                                                                                                                                                                                                                                                                                                                                                                                                                                                                                                                                                                                                                                                                                                                                                                                                                                                                         | IP Object             | None             |             |      |       |             |   |           |      |  |   |           |      |  |   |           |      |  |   |           |      |  |   |           |      |  |   |           |      |  |   |           |      |  |   |           |      |  |   |           |      |  |    |           |      |  |
| 10                                                                                                                                                                                                                                                                                                                                                                                                                                                                                                                                                                                                                                                                                                                                                                                                                                                                                                                                                                                                                                                        | IP Object             | None             |             |      |       |             |   |           |      |  |   |           |      |  |   |           |      |  |   |           |      |  |   |           |      |  |   |           |      |  |   |           |      |  |   |           |      |  |   |           |      |  |    |           |      |  |

OK

Available settings are explained as follows:

| Item                          | Description                                                                                                                                                                                                                                                                                                   |
|-------------------------------|---------------------------------------------------------------------------------------------------------------------------------------------------------------------------------------------------------------------------------------------------------------------------------------------------------------|
| Management Access Control     | Allow management from the Internet - Check to enable the function. Select the servers that system administrators are allowed to manage from the Internet.<br>Disable PING from the Internet - Check to reject all PING packets from the Internet. For increased security, this setting is enabled by default. |
| IPv6 Address Security Option  | Enable Random Interface Identifiers (IIDs)... - The IPv6 address will be generated randomly but not using LAN/WAN MAC to prevent the attack from the hacker.                                                                                                                                                  |
| Access List from the Internet | You could specify that the system administrator can only login from a specific host or network defined in the list. A maximum of three IPs/subnet masks is allowed.                                                                                                                                           |

|  |                                                                                                                                                                                                                                                                                                                                                                                                                                                                                           |
|--|-------------------------------------------------------------------------------------------------------------------------------------------------------------------------------------------------------------------------------------------------------------------------------------------------------------------------------------------------------------------------------------------------------------------------------------------------------------------------------------------|
|  | <p>Apply Access List to PING - When this option is checked and Disable PING from the Internet is unchecked, pings originating from the Internet will be accepted only if they are from one of the IP addresses and/or subnet masks specified below. This option has no effect if Disable PING from the Internet is checked, which blocks all pings from the Internet.</p> <p>Type - Select IP Object or Hostname.</p> <p>Index - Select the index number of a configured IPv6 object.</p> |
|--|-------------------------------------------------------------------------------------------------------------------------------------------------------------------------------------------------------------------------------------------------------------------------------------------------------------------------------------------------------------------------------------------------------------------------------------------------------------------------------------------|

Select OK to save changes on the page.

## LAN Access Setup

System Maintenance >> Management ?

| IPv4 Management Setup                                                                                                                                                                                                                                                                                                                                                                                                                                                                                                                                                                                                                                                                                                                                                                                                                                                                                                                                                                                                                                                                                                                                                                                                                                                                                                                                                                                                                                                                                                                                                                                                                                                                                                                                                                                                                                                                                                                 | IPv6 Management Setup                                              | LAN Access Setup |  |                    |                                          |                                                                    |                                          |                                                                    |                                          |                                                                    |                                          |                                                                    |                                          |                                                                    |                                          |                                                                    |                                          |                                                                    |                                          |                                                                    |                                         |                                                                    |                                                      |                                                                    |
|---------------------------------------------------------------------------------------------------------------------------------------------------------------------------------------------------------------------------------------------------------------------------------------------------------------------------------------------------------------------------------------------------------------------------------------------------------------------------------------------------------------------------------------------------------------------------------------------------------------------------------------------------------------------------------------------------------------------------------------------------------------------------------------------------------------------------------------------------------------------------------------------------------------------------------------------------------------------------------------------------------------------------------------------------------------------------------------------------------------------------------------------------------------------------------------------------------------------------------------------------------------------------------------------------------------------------------------------------------------------------------------------------------------------------------------------------------------------------------------------------------------------------------------------------------------------------------------------------------------------------------------------------------------------------------------------------------------------------------------------------------------------------------------------------------------------------------------------------------------------------------------------------------------------------------------|--------------------------------------------------------------------|------------------|--|--------------------|------------------------------------------|--------------------------------------------------------------------|------------------------------------------|--------------------------------------------------------------------|------------------------------------------|--------------------------------------------------------------------|------------------------------------------|--------------------------------------------------------------------|------------------------------------------|--------------------------------------------------------------------|------------------------------------------|--------------------------------------------------------------------|------------------------------------------|--------------------------------------------------------------------|------------------------------------------|--------------------------------------------------------------------|-----------------------------------------|--------------------------------------------------------------------|------------------------------------------------------|--------------------------------------------------------------------|
| <input checked="" type="checkbox"/> Allow management from LAN <ul style="list-style-type: none"> <li><input checked="" type="checkbox"/> FTP Server</li> <li><input checked="" type="checkbox"/> HTTP Server <input type="checkbox"/> Enforce HTTPS Access</li> <li><input checked="" type="checkbox"/> HTTPS Server</li> <li><input checked="" type="checkbox"/> Telnet Server</li> <li><input checked="" type="checkbox"/> TR069 Server</li> <li><input checked="" type="checkbox"/> SSH Server</li> </ul>                                                                                                                                                                                                                                                                                                                                                                                                                                                                                                                                                                                                                                                                                                                                                                                                                                                                                                                                                                                                                                                                                                                                                                                                                                                                                                                                                                                                                          |                                                                    |                  |  |                    |                                          |                                                                    |                                          |                                                                    |                                          |                                                                    |                                          |                                                                    |                                          |                                                                    |                                          |                                                                    |                                          |                                                                    |                                          |                                                                    |                                         |                                                                    |                                                      |                                                                    |
| <b>Apply To Subnet</b> <table style="width: 100%; border-collapse: collapse;"> <thead> <tr> <th style="width: 70%;"></th> <th style="width: 30%; text-align: center;">Index in IP Object</th> </tr> </thead> <tbody> <tr><td><input checked="" type="checkbox"/> LAN1</td><td style="text-align: center;"><input type="checkbox"/> <input style="width: 100%;" type="text"/></td></tr> <tr><td><input checked="" type="checkbox"/> LAN2</td><td style="text-align: center;"><input type="checkbox"/> <input style="width: 100%;" type="text"/></td></tr> <tr><td><input checked="" type="checkbox"/> LAN3</td><td style="text-align: center;"><input type="checkbox"/> <input style="width: 100%;" type="text"/></td></tr> <tr><td><input checked="" type="checkbox"/> LAN4</td><td style="text-align: center;"><input type="checkbox"/> <input style="width: 100%;" type="text"/></td></tr> <tr><td><input checked="" type="checkbox"/> LAN5</td><td style="text-align: center;"><input type="checkbox"/> <input style="width: 100%;" type="text"/></td></tr> <tr><td><input checked="" type="checkbox"/> LAN6</td><td style="text-align: center;"><input type="checkbox"/> <input style="width: 100%;" type="text"/></td></tr> <tr><td><input checked="" type="checkbox"/> LAN7</td><td style="text-align: center;"><input type="checkbox"/> <input style="width: 100%;" type="text"/></td></tr> <tr><td><input checked="" type="checkbox"/> LAN8</td><td style="text-align: center;"><input type="checkbox"/> <input style="width: 100%;" type="text"/></td></tr> <tr><td><input checked="" type="checkbox"/> DMZ</td><td style="text-align: center;"><input type="checkbox"/> <input style="width: 100%;" type="text"/></td></tr> <tr><td><input checked="" type="checkbox"/> IP Routed Subnet</td><td style="text-align: center;"><input type="checkbox"/> <input style="width: 100%;" type="text"/></td></tr> </tbody> </table> |                                                                    |                  |  | Index in IP Object | <input checked="" type="checkbox"/> LAN1 | <input type="checkbox"/> <input style="width: 100%;" type="text"/> | <input checked="" type="checkbox"/> LAN2 | <input type="checkbox"/> <input style="width: 100%;" type="text"/> | <input checked="" type="checkbox"/> LAN3 | <input type="checkbox"/> <input style="width: 100%;" type="text"/> | <input checked="" type="checkbox"/> LAN4 | <input type="checkbox"/> <input style="width: 100%;" type="text"/> | <input checked="" type="checkbox"/> LAN5 | <input type="checkbox"/> <input style="width: 100%;" type="text"/> | <input checked="" type="checkbox"/> LAN6 | <input type="checkbox"/> <input style="width: 100%;" type="text"/> | <input checked="" type="checkbox"/> LAN7 | <input type="checkbox"/> <input style="width: 100%;" type="text"/> | <input checked="" type="checkbox"/> LAN8 | <input type="checkbox"/> <input style="width: 100%;" type="text"/> | <input checked="" type="checkbox"/> DMZ | <input type="checkbox"/> <input style="width: 100%;" type="text"/> | <input checked="" type="checkbox"/> IP Routed Subnet | <input type="checkbox"/> <input style="width: 100%;" type="text"/> |
|                                                                                                                                                                                                                                                                                                                                                                                                                                                                                                                                                                                                                                                                                                                                                                                                                                                                                                                                                                                                                                                                                                                                                                                                                                                                                                                                                                                                                                                                                                                                                                                                                                                                                                                                                                                                                                                                                                                                       | Index in IP Object                                                 |                  |  |                    |                                          |                                                                    |                                          |                                                                    |                                          |                                                                    |                                          |                                                                    |                                          |                                                                    |                                          |                                                                    |                                          |                                                                    |                                          |                                                                    |                                         |                                                                    |                                                      |                                                                    |
| <input checked="" type="checkbox"/> LAN1                                                                                                                                                                                                                                                                                                                                                                                                                                                                                                                                                                                                                                                                                                                                                                                                                                                                                                                                                                                                                                                                                                                                                                                                                                                                                                                                                                                                                                                                                                                                                                                                                                                                                                                                                                                                                                                                                              | <input type="checkbox"/> <input style="width: 100%;" type="text"/> |                  |  |                    |                                          |                                                                    |                                          |                                                                    |                                          |                                                                    |                                          |                                                                    |                                          |                                                                    |                                          |                                                                    |                                          |                                                                    |                                          |                                                                    |                                         |                                                                    |                                                      |                                                                    |
| <input checked="" type="checkbox"/> LAN2                                                                                                                                                                                                                                                                                                                                                                                                                                                                                                                                                                                                                                                                                                                                                                                                                                                                                                                                                                                                                                                                                                                                                                                                                                                                                                                                                                                                                                                                                                                                                                                                                                                                                                                                                                                                                                                                                              | <input type="checkbox"/> <input style="width: 100%;" type="text"/> |                  |  |                    |                                          |                                                                    |                                          |                                                                    |                                          |                                                                    |                                          |                                                                    |                                          |                                                                    |                                          |                                                                    |                                          |                                                                    |                                          |                                                                    |                                         |                                                                    |                                                      |                                                                    |
| <input checked="" type="checkbox"/> LAN3                                                                                                                                                                                                                                                                                                                                                                                                                                                                                                                                                                                                                                                                                                                                                                                                                                                                                                                                                                                                                                                                                                                                                                                                                                                                                                                                                                                                                                                                                                                                                                                                                                                                                                                                                                                                                                                                                              | <input type="checkbox"/> <input style="width: 100%;" type="text"/> |                  |  |                    |                                          |                                                                    |                                          |                                                                    |                                          |                                                                    |                                          |                                                                    |                                          |                                                                    |                                          |                                                                    |                                          |                                                                    |                                          |                                                                    |                                         |                                                                    |                                                      |                                                                    |
| <input checked="" type="checkbox"/> LAN4                                                                                                                                                                                                                                                                                                                                                                                                                                                                                                                                                                                                                                                                                                                                                                                                                                                                                                                                                                                                                                                                                                                                                                                                                                                                                                                                                                                                                                                                                                                                                                                                                                                                                                                                                                                                                                                                                              | <input type="checkbox"/> <input style="width: 100%;" type="text"/> |                  |  |                    |                                          |                                                                    |                                          |                                                                    |                                          |                                                                    |                                          |                                                                    |                                          |                                                                    |                                          |                                                                    |                                          |                                                                    |                                          |                                                                    |                                         |                                                                    |                                                      |                                                                    |
| <input checked="" type="checkbox"/> LAN5                                                                                                                                                                                                                                                                                                                                                                                                                                                                                                                                                                                                                                                                                                                                                                                                                                                                                                                                                                                                                                                                                                                                                                                                                                                                                                                                                                                                                                                                                                                                                                                                                                                                                                                                                                                                                                                                                              | <input type="checkbox"/> <input style="width: 100%;" type="text"/> |                  |  |                    |                                          |                                                                    |                                          |                                                                    |                                          |                                                                    |                                          |                                                                    |                                          |                                                                    |                                          |                                                                    |                                          |                                                                    |                                          |                                                                    |                                         |                                                                    |                                                      |                                                                    |
| <input checked="" type="checkbox"/> LAN6                                                                                                                                                                                                                                                                                                                                                                                                                                                                                                                                                                                                                                                                                                                                                                                                                                                                                                                                                                                                                                                                                                                                                                                                                                                                                                                                                                                                                                                                                                                                                                                                                                                                                                                                                                                                                                                                                              | <input type="checkbox"/> <input style="width: 100%;" type="text"/> |                  |  |                    |                                          |                                                                    |                                          |                                                                    |                                          |                                                                    |                                          |                                                                    |                                          |                                                                    |                                          |                                                                    |                                          |                                                                    |                                          |                                                                    |                                         |                                                                    |                                                      |                                                                    |
| <input checked="" type="checkbox"/> LAN7                                                                                                                                                                                                                                                                                                                                                                                                                                                                                                                                                                                                                                                                                                                                                                                                                                                                                                                                                                                                                                                                                                                                                                                                                                                                                                                                                                                                                                                                                                                                                                                                                                                                                                                                                                                                                                                                                              | <input type="checkbox"/> <input style="width: 100%;" type="text"/> |                  |  |                    |                                          |                                                                    |                                          |                                                                    |                                          |                                                                    |                                          |                                                                    |                                          |                                                                    |                                          |                                                                    |                                          |                                                                    |                                          |                                                                    |                                         |                                                                    |                                                      |                                                                    |
| <input checked="" type="checkbox"/> LAN8                                                                                                                                                                                                                                                                                                                                                                                                                                                                                                                                                                                                                                                                                                                                                                                                                                                                                                                                                                                                                                                                                                                                                                                                                                                                                                                                                                                                                                                                                                                                                                                                                                                                                                                                                                                                                                                                                              | <input type="checkbox"/> <input style="width: 100%;" type="text"/> |                  |  |                    |                                          |                                                                    |                                          |                                                                    |                                          |                                                                    |                                          |                                                                    |                                          |                                                                    |                                          |                                                                    |                                          |                                                                    |                                          |                                                                    |                                         |                                                                    |                                                      |                                                                    |
| <input checked="" type="checkbox"/> DMZ                                                                                                                                                                                                                                                                                                                                                                                                                                                                                                                                                                                                                                                                                                                                                                                                                                                                                                                                                                                                                                                                                                                                                                                                                                                                                                                                                                                                                                                                                                                                                                                                                                                                                                                                                                                                                                                                                               | <input type="checkbox"/> <input style="width: 100%;" type="text"/> |                  |  |                    |                                          |                                                                    |                                          |                                                                    |                                          |                                                                    |                                          |                                                                    |                                          |                                                                    |                                          |                                                                    |                                          |                                                                    |                                          |                                                                    |                                         |                                                                    |                                                      |                                                                    |
| <input checked="" type="checkbox"/> IP Routed Subnet                                                                                                                                                                                                                                                                                                                                                                                                                                                                                                                                                                                                                                                                                                                                                                                                                                                                                                                                                                                                                                                                                                                                                                                                                                                                                                                                                                                                                                                                                                                                                                                                                                                                                                                                                                                                                                                                                  | <input type="checkbox"/> <input style="width: 100%;" type="text"/> |                  |  |                    |                                          |                                                                    |                                          |                                                                    |                                          |                                                                    |                                          |                                                                    |                                          |                                                                    |                                          |                                                                    |                                          |                                                                    |                                          |                                                                    |                                         |                                                                    |                                                      |                                                                    |

**Note:**  
If an IP Object is specified in a LAN Subnet, the setting will be applied to the selected IP only.

Available settings are explained as follows:

| Item                      | Description                                                                                                                                                                                                                                                                                   |
|---------------------------|-----------------------------------------------------------------------------------------------------------------------------------------------------------------------------------------------------------------------------------------------------------------------------------------------|
| Allow management from LAN | Enable the checkbox to allow system administrators to login from LAN interface. There are several servers provided by the system which allow you to manage the router from LAN interface. Check the box(es) to specify.                                                                       |
| Apply To Subnet           | Check the LAN interface for the administrator to use for accessing into web user interface of Vigor router.<br><b>Index in IP Object</b> - Check the box and enter the index number of the IP object profile. Note that the Address Type selected for that IP object must not be Any Address. |

Select OK to save changes on the page.

## VII-1-12 Panel Control



You may customize the behavior of the LEDs, buttons, WLAN, USB and LAN ports on the front panel.

## For LED

By default, LEDs on the front panel illuminate or blink during operation to show the status of the various functions on the router. However, you may configure them to remain off at all times, or remain off until a button is pressed to wake them up.

System Maintenance >> Panel Control

| LED                                                                                                                                                         | Button | USB | LAN Port | Refresh |
|-------------------------------------------------------------------------------------------------------------------------------------------------------------|--------|-----|----------|---------|
| <input checked="" type="checkbox"/> Enable LED<br><input type="checkbox"/> Enable Sleep Mode<br>Turn off LED after <u>  1  </u> minutes (Default: 1 minute) |        |     |          |         |

**Note:**

Enable the Sleep Mode will make the functions of "Wireless Button" and "Factory Reset Button" on the front panel as below:

| LED Status           | LED On                                                                                       | LED Off      |
|----------------------|----------------------------------------------------------------------------------------------|--------------|
| Wireless Button      | Wireless On/Off/WPS                                                                          | Turn LED On* |
| Factory Reset Button | Press 1 second: Turn LED off immediately*<br>Press till the ACT light flashing: Reset router |              |

\*Still functional even the buttons are disabled.

OK

Available settings are explained as follows:

| Item              | Description                                                                                                                                                                                                                                                                                                                                                                                                                                                                       |
|-------------------|-----------------------------------------------------------------------------------------------------------------------------------------------------------------------------------------------------------------------------------------------------------------------------------------------------------------------------------------------------------------------------------------------------------------------------------------------------------------------------------|
| Refresh           | Click to refresh the page to display the latest information.                                                                                                                                                                                                                                                                                                                                                                                                                      |
| Enable LED        | Select to enable the LEDs to function according to the configured settings.<br>Deselect to disable LEDs entirely.                                                                                                                                                                                                                                                                                                                                                                 |
| Enable Sleep Mode | Select to let the system turn off the LEDs after the specified number of minutes has elapsed.<br>When Sleep Mode is enabled, the LEDs can be woken up by pressing one of the following buttons: <ul style="list-style-type: none"> <li>● Wireless LAN ON/OFF/WPS on the front panel</li> <li>● Factory Reset on the front panel</li> <li>● Wake up LED on this configuration page</li> </ul>  |
| Status            | Shows the status of the LEDs.<br>When the following is shown, the LEDs are in sleep mode.                                                                                                                                                                                                                                                                                                                                                                                         |

|             |                                                                                                                                                                                                                                                                                                                                                                                                                                                                                                                                                                                                                                                                                                                                                                                      |
|-------------|--------------------------------------------------------------------------------------------------------------------------------------------------------------------------------------------------------------------------------------------------------------------------------------------------------------------------------------------------------------------------------------------------------------------------------------------------------------------------------------------------------------------------------------------------------------------------------------------------------------------------------------------------------------------------------------------------------------------------------------------------------------------------------------|
|             | <p><b>Status :</b> Sleep <input type="button" value="Wake up LED"/></p> <p>To wake them up, do one of the following actions:</p> <ul style="list-style-type: none"> <li>● press the Wake up LED button on this page</li> <li>● press the Wireless On/Off/WPS button on the front panel</li> <li>● press the Factory Reset button on the front panel.</li> </ul> <p>When the following is shown, the LEDs are awake.</p> <p><b>Status :</b> Awake, sleep after 1 minutes <input type="button" value="LED sleep immediately"/></p> <p>To put them to sleep immediately, perform one of the following actions:</p> <ul style="list-style-type: none"> <li>● press the LED sleep immediately button on this page</li> <li>● press the Factory Reset button on the front panel</li> </ul> |
| Wake up LED | Click to resume operation of the LED after they have gone to sleep.                                                                                                                                                                                                                                                                                                                                                                                                                                                                                                                                                                                                                                                                                                                  |

Select OK to save changes on the page.

#### For Button

The primary functions of the Factory Reset and Wireless ON/OFF/WPS front-panel buttons (reset to factory defaults and wireless control, respectively) are enabled by default, but they can be enabled or disabled as needed.

When the Factory Reset button is set to Disabled, the router cannot be reset during normal operation. Other functions of the reset button (such as starting up the TFTP server to upload firmware during power on, and controlling the illumination of the front panel LEDs when LED sleep mode is enabled) can still be used.

When the Wireless ON/OFF/WPS button is set to Disabled, the button cannot be used to turn on or off the wireless network, nor can it be used to start the WPS pairing process. However, the front panel LEDs can be woken up when LED sleep mode is enabled.

Click the Button tab to get the following page.

| LED                                                                                                                                                                                                                                                                                                                       | Button        | USB | LAN Port | Refresh |        |        |                                     |          |                                     |               |
|---------------------------------------------------------------------------------------------------------------------------------------------------------------------------------------------------------------------------------------------------------------------------------------------------------------------------|---------------|-----|----------|---------|--------|--------|-------------------------------------|----------|-------------------------------------|---------------|
| <table border="1"> <thead> <tr> <th>Enable</th> <th>Button</th> </tr> </thead> <tbody> <tr> <td style="text-align: center;"><input checked="" type="checkbox"/></td> <td>Wireless</td> </tr> <tr> <td style="text-align: center;"><input checked="" type="checkbox"/></td> <td>Factory Reset</td> </tr> </tbody> </table> |               |     |          |         | Enable | Button | <input checked="" type="checkbox"/> | Wireless | <input checked="" type="checkbox"/> | Factory Reset |
| Enable                                                                                                                                                                                                                                                                                                                    | Button        |     |          |         |        |        |                                     |          |                                     |               |
| <input checked="" type="checkbox"/>                                                                                                                                                                                                                                                                                       | Wireless      |     |          |         |        |        |                                     |          |                                     |               |
| <input checked="" type="checkbox"/>                                                                                                                                                                                                                                                                                       | Factory Reset |     |          |         |        |        |                                     |          |                                     |               |

**Note:**

Enable the Sleep Mode will make the functions of "Wireless Button" and "Factory Reset Button" on the front panel as below:

| LED Status           | LED On                                                                                       | LED Off      |
|----------------------|----------------------------------------------------------------------------------------------|--------------|
| Wireless Button      | Wireless On/Off/WPS                                                                          | Turn LED On* |
| Factory Reset Button | Press 1 second: Turn LED off immediately*<br>Press till the ACT light flashing: Reset router |              |

\*Still functional even the buttons are disabled.

OK

Available settings are explained as follows:

| Item                        | Description                                                                                                                                                                                                                                                                                        |
|-----------------------------|----------------------------------------------------------------------------------------------------------------------------------------------------------------------------------------------------------------------------------------------------------------------------------------------------|
| Refresh                     | Click to refresh the page to display the latest information.                                                                                                                                                                                                                                       |
| Enable Factory Reset Button | The default value is Enabled.<br>Deselect to disable the reset function of the factory reset button.<br>Disabling the Factory Reset button only prevents it from being used to reboot Vigor router with default settings. It can still be used to wake up the LEDs when LED sleep mode is enabled. |
| Enable Wireless Button      | The default value is Enabled.<br>Deselect to disable the ability of the Wireless button to control WLAN and WPS functions.<br>Disabling the wireless button only prevents it from being used to control WLAN functions. It can still be used to wake up the LEDs when LED sleep mode is enabled.   |

Select OK to save changes on the page.

**For USB**

The USB ports can be individually enabled or disabled. When a USB port is disabled, attached devices will not be recognized by the router.

| LED                                                                                                                                                                                                                                                                                                                                                                                                                | Button                              | USB       | LAN Port | Refresh |      |        |        |   |                                     |           |   |                                     |           |
|--------------------------------------------------------------------------------------------------------------------------------------------------------------------------------------------------------------------------------------------------------------------------------------------------------------------------------------------------------------------------------------------------------------------|-------------------------------------|-----------|----------|---------|------|--------|--------|---|-------------------------------------|-----------|---|-------------------------------------|-----------|
| <table border="1"> <thead> <tr> <th>Port</th> <th>Enable</th> <th>Status</th> </tr> </thead> <tbody> <tr> <td style="text-align: center;">1</td> <td style="text-align: center;"><input checked="" type="checkbox"/></td> <td>No Device</td> </tr> <tr> <td style="text-align: center;">2</td> <td style="text-align: center;"><input checked="" type="checkbox"/></td> <td>No Device</td> </tr> </tbody> </table> |                                     |           |          |         | Port | Enable | Status | 1 | <input checked="" type="checkbox"/> | No Device | 2 | <input checked="" type="checkbox"/> | No Device |
| Port                                                                                                                                                                                                                                                                                                                                                                                                               | Enable                              | Status    |          |         |      |        |        |   |                                     |           |   |                                     |           |
| 1                                                                                                                                                                                                                                                                                                                                                                                                                  | <input checked="" type="checkbox"/> | No Device |          |         |      |        |        |   |                                     |           |   |                                     |           |
| 2                                                                                                                                                                                                                                                                                                                                                                                                                  | <input checked="" type="checkbox"/> | No Device |          |         |      |        |        |   |                                     |           |   |                                     |           |

OK

Available settings are explained as follows:

| Item    | Description                                                                                                                                                                       |
|---------|-----------------------------------------------------------------------------------------------------------------------------------------------------------------------------------|
| Refresh | Click to refresh the page to display the latest information.                                                                                                                      |
| Port    | The number corresponds to the USB port number shown on the front panel.                                                                                                           |
| Enable  | Deselect to disable the USB port. The default value is enabled.                                                                                                                   |
| Status  | Shows the status of the USB port.<br>No device - no USB device is connected to the port.<br>Connected - a USB device is connected to the port.<br>--- - the USB port is disabled. |

Select OK to save changes on the page.

## For LAN Port

The 5 LAN ports can be individually enabled or disabled. When a LAN port is disabled, attached devices will not be recognized by the router.

System Maintenance >> Panel Control

| LED                                                                                                                                                                                                                                                                                                                                                                                                                                                                                                                                                                                                                                                     | Button                              | USB       | LAN Port | Refresh |      |        |        |       |   |                                     |           |     |   |                                     |           |     |   |                                     |         |          |   |                                     |           |     |   |                                     |           |     |
|---------------------------------------------------------------------------------------------------------------------------------------------------------------------------------------------------------------------------------------------------------------------------------------------------------------------------------------------------------------------------------------------------------------------------------------------------------------------------------------------------------------------------------------------------------------------------------------------------------------------------------------------------------|-------------------------------------|-----------|----------|---------|------|--------|--------|-------|---|-------------------------------------|-----------|-----|---|-------------------------------------|-----------|-----|---|-------------------------------------|---------|----------|---|-------------------------------------|-----------|-----|---|-------------------------------------|-----------|-----|
| <table border="1"> <thead> <tr> <th>Port</th> <th>Enable</th> <th>Status</th> <th>Speed</th> </tr> </thead> <tbody> <tr> <td>1</td> <td><input checked="" type="checkbox"/></td> <td>Link Down</td> <td>---</td> </tr> <tr> <td>2</td> <td><input checked="" type="checkbox"/></td> <td>Link Down</td> <td>---</td> </tr> <tr> <td>3</td> <td><input checked="" type="checkbox"/></td> <td>Link Up</td> <td>1000Mbps</td> </tr> <tr> <td>4</td> <td><input checked="" type="checkbox"/></td> <td>Link Down</td> <td>---</td> </tr> <tr> <td>5</td> <td><input checked="" type="checkbox"/></td> <td>Link Down</td> <td>---</td> </tr> </tbody> </table> |                                     |           |          |         | Port | Enable | Status | Speed | 1 | <input checked="" type="checkbox"/> | Link Down | --- | 2 | <input checked="" type="checkbox"/> | Link Down | --- | 3 | <input checked="" type="checkbox"/> | Link Up | 1000Mbps | 4 | <input checked="" type="checkbox"/> | Link Down | --- | 5 | <input checked="" type="checkbox"/> | Link Down | --- |
| Port                                                                                                                                                                                                                                                                                                                                                                                                                                                                                                                                                                                                                                                    | Enable                              | Status    | Speed    |         |      |        |        |       |   |                                     |           |     |   |                                     |           |     |   |                                     |         |          |   |                                     |           |     |   |                                     |           |     |
| 1                                                                                                                                                                                                                                                                                                                                                                                                                                                                                                                                                                                                                                                       | <input checked="" type="checkbox"/> | Link Down | ---      |         |      |        |        |       |   |                                     |           |     |   |                                     |           |     |   |                                     |         |          |   |                                     |           |     |   |                                     |           |     |
| 2                                                                                                                                                                                                                                                                                                                                                                                                                                                                                                                                                                                                                                                       | <input checked="" type="checkbox"/> | Link Down | ---      |         |      |        |        |       |   |                                     |           |     |   |                                     |           |     |   |                                     |         |          |   |                                     |           |     |   |                                     |           |     |
| 3                                                                                                                                                                                                                                                                                                                                                                                                                                                                                                                                                                                                                                                       | <input checked="" type="checkbox"/> | Link Up   | 1000Mbps |         |      |        |        |       |   |                                     |           |     |   |                                     |           |     |   |                                     |         |          |   |                                     |           |     |   |                                     |           |     |
| 4                                                                                                                                                                                                                                                                                                                                                                                                                                                                                                                                                                                                                                                       | <input checked="" type="checkbox"/> | Link Down | ---      |         |      |        |        |       |   |                                     |           |     |   |                                     |           |     |   |                                     |         |          |   |                                     |           |     |   |                                     |           |     |
| 5                                                                                                                                                                                                                                                                                                                                                                                                                                                                                                                                                                                                                                                       | <input checked="" type="checkbox"/> | Link Down | ---      |         |      |        |        |       |   |                                     |           |     |   |                                     |           |     |   |                                     |         |          |   |                                     |           |     |   |                                     |           |     |

OK

Available settings are explained as follows:

| Item    | Description                                                                                                                                                                                                                                                                                            |
|---------|--------------------------------------------------------------------------------------------------------------------------------------------------------------------------------------------------------------------------------------------------------------------------------------------------------|
| Refresh | Click to refresh the page to display the latest information.                                                                                                                                                                                                                                           |
| Port    | The number corresponds to the LAN port number shown on the front panel.                                                                                                                                                                                                                                |
| Enable  | Deselect to disable the LAN port. The default value is enabled.                                                                                                                                                                                                                                        |
| Status  | Shows the status of the USB port.<br>Link Up - An active Ethernet device is connected to the port.<br>Link Down - No active Ethernet device is detected.<br>--- - The LAN port is disabled.                                                                                                            |
| Speed   | Shows the negotiated speed of the LAN port.<br>1000Mbps - Negotiated speed of the LAN port is 1000 Mbps.<br>100Mbps - Negotiated speed of the LAN port is 100 Mbps.<br>10Mbps - Negotiated speed of the LAN port is 10 Mbps.<br>--- - The LAN port is disabled or there is no active device connected. |

Select OK to save changes on the page.

## VII-1-13 Self-Signed Certificate

A self-signed certificate is a *unique* identification for the device (e.g., Vigor router) which generates the certificate by itself to ensure the router security. Such self-signed certificate is signed with its own private key.

The self-signed certificate can be used for services such as SSL VPN and HTTPS. In addition, it can be created for free by using a wide variety of tools.

System Maintenance >> Self-Signed Certificate

### Self-Signed Certificate Information

|                            |                                                                                                                                                                                                                                                                                                                                                                                                                                                                                                                                                                                                                                                                                                                                                                                                    |
|----------------------------|----------------------------------------------------------------------------------------------------------------------------------------------------------------------------------------------------------------------------------------------------------------------------------------------------------------------------------------------------------------------------------------------------------------------------------------------------------------------------------------------------------------------------------------------------------------------------------------------------------------------------------------------------------------------------------------------------------------------------------------------------------------------------------------------------|
| Certificate Name :         | self-signed                                                                                                                                                                                                                                                                                                                                                                                                                                                                                                                                                                                                                                                                                                                                                                                        |
| Issuer :                   | C=TW, ST=HsinChu, L=HuKou, O=DrayTek Corp., OU=DrayTek Support, CN=Vigor Router                                                                                                                                                                                                                                                                                                                                                                                                                                                                                                                                                                                                                                                                                                                    |
| Subject :                  | C=TW, ST=HsinChu, L=HuKou, O=DrayTek Corp., OU=DrayTek Support, CN=Vigor Router                                                                                                                                                                                                                                                                                                                                                                                                                                                                                                                                                                                                                                                                                                                    |
| Subject Alternative Name : | DNS:www.draytek.com                                                                                                                                                                                                                                                                                                                                                                                                                                                                                                                                                                                                                                                                                                                                                                                |
| Valid From :               | Jul 7 11:50:06 2020 GMT                                                                                                                                                                                                                                                                                                                                                                                                                                                                                                                                                                                                                                                                                                                                                                            |
| Valid To :                 | Jul 7 11:50:06 2022 GMT                                                                                                                                                                                                                                                                                                                                                                                                                                                                                                                                                                                                                                                                                                                                                                            |
| PEM Format Content :       | <pre>-----BEGIN CERTIFICATE----- MIIDpjCCAo6gAwIBAgIJAM5Q46fLi+1oMA0GCSqGSIb3DQEBCwUAMHgx CzA3B8g NV BAYTA1RXMRAwDgYDVQQIDAdIc2luQ2h1MQ4wDAYDVQQHDAVIdUtv dTEwMBQGA1 UE CgwNRHJheVR1ayBDb3JwLjEYMBYGA1UECwwPRHJheVR1ayBTdXBwb3J0MRUwEw YD VQQDDAxWaldvc iB5b3V0ZXIwHhcNMjAwNzA3MTE1MDA2W hcNMjIwNzA3MTE1MD A2 WjB4MQswCQYDVQQGEwJUVzEQMA4GA1UECAwHSHNpbkNodTE0AwGA1UEBwwFSH VL b3Ux FjAUBGNVBAoMDURyYX1UZWsgQ29ycC4xGDAwBgNVBA sMD0RyYX1UZWsgU3 Vw cG9ydDEVMBMGA1UEAwMMVmlnb3I gUm91dGVyMIIBIjANBgkqhkiG9w0BAQEFAA OC AQ8AMIIBCgKCAQEAE0QFcz9DSwors6Ext dyTRkposUi2mNmwlvfIjTdlK95yo8W 41 FnPZnm3UYvc0gVVwWR7jnb90Q/CEMNaLBz0tvlyjKo0tCF2+aXB3aUvKZmd6LY Iw b5WZl7DvKde3D7sTBGh1w/V0sLKIc260ZuY0vQB6NtzSrXNYQ+X2SOZvL9wbmb yS N1pIYgyj1LDpHrDH0WPAFQLn//ij/XZFq7Z00yyyFEtk9Rfms6NPbFbJA/W1v7</pre> |

#### Note:

1. Please setup the [System Maintenance >> Time and Date](#) correctly before you try to regenerate a self-signed certificate!!
2. The Time Zone MUST be setup correctly!!

Regenerate

Click Regenerate to open Regenerate Self-Signed Certificate window.

Regenerate Self-Signed Certificate

|                                 |                      |
|---------------------------------|----------------------|
| <b>Certificate Name</b>         | self-signed          |
| <b>Subject Alternative Name</b> |                      |
| Type                            | IP Address ▾         |
| IP                              | <input type="text"/> |
| <b>Subject Name</b>             |                      |
| Country (C)                     | <input type="text"/> |
| State (ST)                      | <input type="text"/> |
| Location (L)                    | <input type="text"/> |
| Organization (O)                | <input type="text"/> |
| Organization Unit (OU)          | <input type="text"/> |
| Common Name (CN)                | <input type="text"/> |
| Email (E)                       | <input type="text"/> |
| <b>Key Type</b>                 | RSA ▾                |
| <b>Key Size</b>                 | 2048 Bit ▾           |

Enter all requested information including certificate name (used to differentiate different certificates), subject alternative name type and relational settings for subject name. Then click GENERATE.

## VII-1-14 Reboot System

The Web user interface may be used to restart your router. Click Reboot System from System Maintenance to bring up the following page.

System Maintenance >> Reboot System

**Reboot System**

Do you want to reboot your router ?

Using current configuration  
 Using factory default configuration

**Auto Reboot Time Schedule**

**Schedule Profile :**  ,  ,  ,

**Note:**  
Action and Duration Time settings will be ignored.

Available settings are explained as follows:

| Item                      | Description                                                                                                                                                                                                                                                                                                                                    |
|---------------------------|------------------------------------------------------------------------------------------------------------------------------------------------------------------------------------------------------------------------------------------------------------------------------------------------------------------------------------------------|
| Reboot System             | Select one of the following options, and press the Reboot Now button to reboot the router.<br>Using current configuration - Select this option to reboot the router using the current configuration.<br>Using factory default configuration - Select this option to reset the router's configuration to the factory defaults before rebooting. |
| Auto Reboot Time Schedule | Schedule Profile - Select up to 4 user-configured schedules to reboot the router on a scheduled basis.                                                                                                                                                                                                                                         |

Select OK to save changes on the page, or Cancel to discard changes without saving.



### Info

When the system pops up Reboot System web page after you configure web settings, please click Reboot Now to reboot your router for ensuring normal operation and preventing unexpected errors of the router in the future.



---

## VII-1-15 Firmware Upgrade

Click System Maintenance>> Firmware Upgrade to upgrade firmware upgrade.

System Maintenance >> Firmware Upgrade



### Firmware Version Status

|                                                                                                        |
|--------------------------------------------------------------------------------------------------------|
| Current Firmware Version: 4.4.2.2                                                                      |
| Latest Firmware Version: 4.4.2.2                                                                       |
| <input type="button" value="Download Directly"/> <input type="button" value="Latest Firmware Detail"/> |

Download Link: <https://www.draytek.com/support/latest-firmwares/>

### Web Firmware Upgrade

|                                                                                                                 |
|-----------------------------------------------------------------------------------------------------------------|
| Select a firmware file.                                                                                         |
| <input type="button" value="選擇檔案"/> 未選擇任何檔案                                                                     |
| Click Upgrade to upload the file. <input type="button" value="Upgrade"/> <input type="button" value="Preview"/> |

**Note:**

Upgrade using the ALL file will retain existing router configuration, whereas using the RST file will reset the configuration to factory defaults.

Available settings are explained as follows:

| Item                    | Description                                                                                                                                                                                                                                                                             |
|-------------------------|-----------------------------------------------------------------------------------------------------------------------------------------------------------------------------------------------------------------------------------------------------------------------------------------|
| Firmware Version Status | Check The Latest Firmware - Click to check for updated firmware.<br>Any available new firmware files will be displayed and you can download any one of them by clicking Download. After the file has been downloaded, click Select followed by Upgrade to perform the firmware upgrade. |
| Web Firmware Upgrade    | Click Browse... to select the firmware file, followed by Upgrade to start the upgrade process, or Preview to display detailed information about the selected firmware file:                                                                                                             |

## VII-1-16 Firmware Backup

The firmware for Vigor router can be saved on the host as a backup firmware. After that, if the router crashes due to the firmware error, the backup firmware will be applied to make the router run normally.

System Maintenance >> Firmware Backup

### Automatic Firmware Recovery

Enable automatic firmware recovery

If the router unexpectedly reboots three times in a row then the backup firmware will be restored to the unit on the third reboot.

### Backup Setting

Backup after reboot

Backup after system uptime of  day  hour (max. 7 days)

Backup manually

Backup Firmware: 4.4.0

Last backup:2000/01/02 00:00:28

OK

Cancel

Available settings are explained as follows:

| Item                        | Description                                                                                                                                                                                                                                                                                                                                                                                                                                                                                                                                                                                                                                                                                               |
|-----------------------------|-----------------------------------------------------------------------------------------------------------------------------------------------------------------------------------------------------------------------------------------------------------------------------------------------------------------------------------------------------------------------------------------------------------------------------------------------------------------------------------------------------------------------------------------------------------------------------------------------------------------------------------------------------------------------------------------------------------|
| Automatic Firmware Recovery | Enable automatic firmware recovery- If this option is enabled, the router will restore the most recently backed-up firmware after the router reboots unexpectedly three times.                                                                                                                                                                                                                                                                                                                                                                                                                                                                                                                            |
| Backup Setting              | <p>This option controls the backup behavior of the router.</p> <ul style="list-style-type: none"> <li>● Backup after reboot - The router makes a copy of the current firmware immediately after it reboots</li> <li>● Backup after system uptime... - The router makes a copy of the current firmware after it has run for the specified length of time after boot-up.</li> <li>● Backup manually - the router will not automatically create a backup copy of the firmware. Click this option and click OK, firmware backup will be performed immediately.</li> </ul> <p>Backup Firmware - Displays recent firmware backup version.</p> <p>Last backup - Displays the time of recent firmware backup.</p> |

Select OK to save changes on the page, or Cancel to discard changes without saving.

## VII-1-17 Internal Service User List

User profiles (clients) defined and enabled in User Management>>User Profile will be displayed in this page.

Such page allows you to turn on or turn off security authentication service (offered by internal RADIUS and/or Local 802.1X) for each user profile without accessing into the User Management configuration page.

System Maintenance >> Internal Service User List

| User Name             | <input type="checkbox"/> Radius | <input type="checkbox"/> Local 802.1X | User Name | <input type="checkbox"/> Radius | <input type="checkbox"/> Local 802.1X |
|-----------------------|---------------------------------|---------------------------------------|-----------|---------------------------------|---------------------------------------|
| No valid User Profile |                                 |                                       |           |                                 |                                       |

**Note:**

1. Only the user profiles which is enabled in User **Management >> User Profile** will be listed here.
2. If you enable RADIUS or Local 802.1X for a user profile here, it will use the default authentication methods; however, you may change its authentication methods via User **Management >> User Profile**.

Available settings are explained as follows:

| Item         | Description                                                                                                                                                                                                                                                                                                                                                                                                 |
|--------------|-------------------------------------------------------------------------------------------------------------------------------------------------------------------------------------------------------------------------------------------------------------------------------------------------------------------------------------------------------------------------------------------------------------|
| User Name    | Display the name of the existed user profile. To modify the detailed settings, simply click the user name link to access into the web page for modification.                                                                                                                                                                                                                                                |
| Radius       | <p>Check the box to turn on the security authentication service offered by internal RADIUS server for the user profile.</p> <p>Uncheck the box to turn off security authentication service offered by internal RADIUS server for the user profile.</p> <p>If you check the box next to such item, all of the user profiles listed in this page will be enabled with RADIUS service enabled vice versa.</p>  |
| Local 802.1X | <p>Check the box to turn on the security authentication service offered by Local 802.1X server for the user profile.</p> <p>Uncheck the box to turn off security authentication service offered by Local 802.1X server for the user profile.</p> <p>If you check the box next to such item, all of the user profiles listed in this page will be enabled with Local 802.1X service enabled; vice versa.</p> |



**Info**

For the detailed setting (such as IP address, port number) configuration of internal RADIUS, refer to Applications>>RADIUS/TACACS+.

For the detailed setting (such as IP address, port number) configuration of Local 802.1X, refer to LAN>>Wired 802.1X and Wireless LAN>>Security.

---

## VII-1-18 Dashboard Control

There are nine groups of setting information which can be displayed on Dashboard as a reference for administrator/user. Except for Front Panel and System Information, the settings information regarding to the groups listed on this page can be hidden if required.

System Maintenance >> Dashboard Control

---

- Front Panel
- System Information
- IPv4 LAN Information
- IPv4 Internet Access
- IPv6 Internet Access
- Interface
- Security
- System Resource
- LTE Status
- Quick Access

---

## VII-2 Bandwidth Management

### Sessions Limit

When LAN clients share a common public IP address by means of Network Address Translation (NAT), the router must track NAT sessions so that traffic to and from the WAN can reach the intended destinations. There is a finite number of sessions that can be tracked by the router, and by setting session limits will ensure that the router does not run out of resources. This is especially important when P2P applications are used. P2P applications, such as BitTorrent, that attempt to simultaneously establish connections to as many WAN hosts as possible.

### Bandwidth Limit

Bandwidth Limit ensures LAN clients get their fair share of network bandwidth by placing restrictions on upstream and downstream network speeds.

### Quality of Service (QoS)

QoS (Quality of Service) ensures that all LAN clients receive their fair share of bandwidth that is required for applications to function properly and efficiently.

Without QoS, it is possible that certain applications may consume excessive network resources that they degrade performance of more important applications, especially ones that are less tolerant of jitter (delay variation) or lost or delayed packets. Additionally, at times of network congestion, QoS is able to prioritize different types of traffic according to their predefined priority, thus ensuring traffic of higher importance gets processed first.

A typical QoS deployment consists of two components:

- **Classification:** Identifying low-latency or crucial applications and marking them for high-priority service level enforcement throughout the network.
- **Scheduling:** Prioritizing packets by assigning them to different queues and service types according to service levels.

### APP QoS

APP QoS allows QoS to be applied to select protocols and applications.

Protocols and applications fall into two categories: Traceable and Untraceable. Traceable applications are those whose traffic can be 100% traced, and can be assigned a specific QoS class. Untraceable applications, on the other hand, are detected when they attempt to establish connections to remote hosts, and all traffic between the remote hosts and the local network will be placed under QoS, within the same QoS class.

## Web User Interface

Bandwidth management ensures efficient allocation of network bandwidth for various applications.

To set up Bandwidth Management, from the Main Menu, select Bandwidth Management.



### VII-2-1 Sessions Limit

To configure Sessions Limit, from the Bandwidth Management menu, select Sessions Limit to open the setup page.

Bandwidth Management >> Sessions Limit

IPv4
IPv6

Enable
  Disable

Default Max Sessions:

5  entries per page

**Limitation List (Max. 20 entries)**

| Index | Start IP | End IP | Max Sessions |
|-------|----------|--------|--------------|
|       |          |        |              |

**Specific Limitation**

Start IP:  End IP:

Maximum Sessions:

**Administration Message (Max 255 characters)**

You have reached the maximum number of permitted Internet sessions.<p>Please close one or more applications to allow further Internet access.<p>Contact your system administrator for further information.

**Time Schedule**

Schedule Profile:

Note: Action and Idle Timeout settings will be ignored.

Available settings are explained as follows:

| Item             | Description                                                                                                                                                                                                                                                                      |
|------------------|----------------------------------------------------------------------------------------------------------------------------------------------------------------------------------------------------------------------------------------------------------------------------------|
| Enable / Disable | Enable - Select to activate session limit function.<br>Disable - Select to deactivate session limit function.<br>Default Max Session - The default maximum number of sessions allowed per LAN client, unless overridden by specifying a different number in the Limitation List. |

|                               |                                                                                                                                                                                                                                                                                                                                                                                                                                                                                                                                                                                                                                 |
|-------------------------------|---------------------------------------------------------------------------------------------------------------------------------------------------------------------------------------------------------------------------------------------------------------------------------------------------------------------------------------------------------------------------------------------------------------------------------------------------------------------------------------------------------------------------------------------------------------------------------------------------------------------------------|
| <b>Limitation List</b>        | Displays specific limitation entries.                                                                                                                                                                                                                                                                                                                                                                                                                                                                                                                                                                                           |
| <b>Specific Limitation</b>    | <p>Start IP - The beginning IP address for this limit entry.</p> <p>End IP - The ending IP address for limit entry.</p> <p>Maximum Sessions - The maximum number of NAT sessions allowed per LAN client. If no value is entered, the Default Max Sessions value is used.</p> <p>Add - Creates a new limit entry using the above Specific Limitation values.</p> <p>Edit - To edit an existing entry, select the entry from the Limitation List, make the appropriate changes in Specific Limitation, then click Edit.</p> <p>Delete - To delete an entry, select it from the Limitation List, then click the Delete button.</p> |
| <b>Administration Message</b> | <p>Message to be displayed in a web browser on the LAN client when the maximum number of NAT sessions has been reached.</p> <p>Default Message - Click to reset the administration message to the factory default.</p>                                                                                                                                                                                                                                                                                                                                                                                                          |
| <b>Time Schedule</b>          | Schedule Profile - Specify up to 4 time schedule entries to enable or disable the WAN.                                                                                                                                                                                                                                                                                                                                                                                                                                                                                                                                          |

To save changes on the page, click OK.

## VII-2-2 Bandwidth Limit

To configure the Bandwidth Limit feature, from the Bandwidth Management menu, select Bandwidth Limit to bring up the configuration pages for IPv4, IPv6 and APP. Here we take IPv4 as an example.

Bandwidth Management >> Bandwidth Limit

IPv4
IPv6
APP

Enable
  Disable
  IP Routed Subnet

**Default Limit (Per User)**  
 TX Limit:  
 RX Limit:

entries per page

**Limitation List (Max. 20 entries)**

| Index | Start IP/Group | End IP/Object | TX limit | RX limit | Shared |
|-------|----------------|---------------|----------|----------|--------|
|       |                |               |          |          |        |

Add Entry By:  IP Range
  IP Object
 Start IP: 
 End IP:

Each
  Shared
 TX Limit:  
 RX Limit:

**Auto-Adjustment**  
 Allow user to use more bandwidth than the assigned limit when there are bandwidth available.

**Smart Bandwidth Limit**  
 Apply the below limit to users not in Limitation List and user more than  sessions  
 TX Limit:  
 RX Limit:

**Time Schedule**  
 Schedule Profile:

**Note:**

1. Set "0" for TX/RX Limit for unlimited bandwidth.
2. Available bandwidth is calculated according to the maximum bandwidth detected or the Line Speed defined in WAN >> [General Setup](#) when in "According to Line Speed" Load Balance mode.
3. The Action and Idle Timeout settings in the Schedule Profile will be ignored.
4. When Bandwidth Limit is enabled, the IPs applied with Bandwidth Limit cannot be accelerated by the Hardware Acceleration.

Available settings are explained as follows:

| Item             | Description                                                                                                                                                                                                                                                                                                                                                                                                                                                                                                      |
|------------------|------------------------------------------------------------------------------------------------------------------------------------------------------------------------------------------------------------------------------------------------------------------------------------------------------------------------------------------------------------------------------------------------------------------------------------------------------------------------------------------------------------------|
| Enable / Disable | Enable - Select to activate bandwidth limit function.<br>Disable - Select to deactivate bandwidth limit function.<br><b>Default Limit (Per User)</b> <ul style="list-style-type: none"> <li>● TX Limit - Default upstream speed limit for each LAN client. Unit can be either Kbps or Mbps. Value must be between 0 (unlimited) and 30000.</li> <li>● RX limit - Default downstream speed limit for each LAN client. Unit can be either Kbps or Mbps. Value must be between 0 (unlimited) and 30000).</li> </ul> |
| Limitation List  | Displays specific limitation entries.                                                                                                                                                                                                                                                                                                                                                                                                                                                                            |
| Add Entry By     | IP Range - All the IPs within the range defined will be restricted by bandwidth limit defined by TX Limit and RX Limit below.                                                                                                                                                                                                                                                                                                                                                                                    |



|                       |                                                                                                                                                                                                                                                                                                                                                                                                                                                                                                                                                                                                                                                                                                                                                                                                                                                                                                                                                                                                                                                                                                                                                                                                                                                                                                                                                                          |
|-----------------------|--------------------------------------------------------------------------------------------------------------------------------------------------------------------------------------------------------------------------------------------------------------------------------------------------------------------------------------------------------------------------------------------------------------------------------------------------------------------------------------------------------------------------------------------------------------------------------------------------------------------------------------------------------------------------------------------------------------------------------------------------------------------------------------------------------------------------------------------------------------------------------------------------------------------------------------------------------------------------------------------------------------------------------------------------------------------------------------------------------------------------------------------------------------------------------------------------------------------------------------------------------------------------------------------------------------------------------------------------------------------------|
|                       | <ul style="list-style-type: none"> <li>● Start IP - The beginning IP address for this limit entry.</li> <li>● End IP - The ending IP address for limit entry.</li> </ul> <p>IP Object - All the IPs specified by the selected IP object or IP group will be restricted by bandwidth limit defined by TX Limit and RX Limit below.</p> <ul style="list-style-type: none"> <li>● IP Group - Specify an IP group by using the drop down list.</li> <li>● IP Object - Specify an IP object by using the drop down list.</li> </ul> <p>Each - The specified bandwidth is the limit per LAN client.<br/> Shared - The specified bandwidth limits are the total allowed for all LAN clients within the range of IP addresses.</p> <ul style="list-style-type: none"> <li>● TX limit - The upstream limit. Unit can be either Kbps or Mbps. Value must be between 0 (unlimited) and 30000.</li> <li>● RX limit - The downstream limit. Unit can be either Kbps or Mbps. Value must be between 0 (unlimited) and 30000.</li> </ul> <p>Add - Creates a new limit entry using the above Specific Limitation values.<br/> Edit - To edit an existing entry, select the entry from the Limitation List, make the appropriate changes in Specific Limitation, then click Edit.<br/> Delete - To delete an entry, select it from the Limitation List, then click the Delete button.</p> |
| Auto-Adjustment       | Allow user to use more bandwidth ...- Select to let the router automatically adjust the upstream and downstream limits based on available bandwidth.                                                                                                                                                                                                                                                                                                                                                                                                                                                                                                                                                                                                                                                                                                                                                                                                                                                                                                                                                                                                                                                                                                                                                                                                                     |
| Smart Bandwidth Limit | <p>This option restricts the bandwidth of LAN clients that are not in the limitation list when the network sessions exceed a predefined threshold.</p> <p>Apply the below limit to ... - The number of sessions a LAN client is allowed to have before Smart Bandwidth Limit activates.</p> <ul style="list-style-type: none"> <li>● TX limit - Upstream speed limit for each LAN client. Unit can be either Kbps or Mbps. Value must be between 0 (unlimited) and 30000.</li> <li>● RX limit - Downstream speed limit for each LAN client. Unit can be either Kbps or Mbps. Value must be between 0 (unlimited) and 30000).</li> </ul>                                                                                                                                                                                                                                                                                                                                                                                                                                                                                                                                                                                                                                                                                                                                  |
| Time Schedule         | Schedule Profile - Specify up to 4 time schedule entries to enable or disable the WAN.                                                                                                                                                                                                                                                                                                                                                                                                                                                                                                                                                                                                                                                                                                                                                                                                                                                                                                                                                                                                                                                                                                                                                                                                                                                                                   |

To save changes on the page, click OK.

## VII-2-3 Quality of Service

To configure Quality of Service, from the main menu, select Bandwidth Management menu, then click Quality of Service to bring up the configuration page.

Bandwidth Management >> Quality of Service

**Hardware QoS General Setup** | [Set to Factory Default](#) |

| Index | Enable                   | Direction         | Egress Bandwidth |        | Class 1 | Class 2 | Class 3 | Others | Status                 |
|-------|--------------------------|-------------------|------------------|--------|---------|---------|---------|--------|------------------------|
| WAN1  | <input type="checkbox"/> | Egress (Upload)   | 1000             | Mbps ▾ | 25 %    | 25 %    | 25 %    | 25 %   | <a href="#">Status</a> |
| WAN2  | <input type="checkbox"/> | Egress (Upload)   | 1000             | Mbps ▾ | 25 %    | 25 %    | 25 %    | 25 %   | <a href="#">Status</a> |
| Port1 | <input type="checkbox"/> | Egress (Download) | 1000             | Mbps ▾ | 25 %    | 25 %    | 25 %    | 25 %   | <a href="#">Status</a> |
| Port2 | <input type="checkbox"/> | Egress (Download) | 1000             | Mbps ▾ | 25 %    | 25 %    | 25 %    | 25 %   | <a href="#">Status</a> |
| Port3 | <input type="checkbox"/> | Egress (Download) | 1000             | Mbps ▾ | 25 %    | 25 %    | 25 %    | 25 %   | <a href="#">Status</a> |
| Port4 | <input type="checkbox"/> | Egress (Download) | 1000             | Mbps ▾ | 25 %    | 25 %    | 25 %    | 25 %   | <a href="#">Status</a> |
| Port5 | <input type="checkbox"/> | Egress (Download) | 1000             | Mbps ▾ | 25 %    | 25 %    | 25 %    | 25 %   | <a href="#">Status</a> |

Note:

1. Please enable hardware acceleration so Hardware QoS will work.
2. Hardware QoS has higher priority than Software QoS.

### Software QoS General Setup

| Index       | Enable                   | Direction | Ingress / Egress Bandwidth |              | Class 1 | Class 2 | Class 3 | Others | Status |                        |
|-------------|--------------------------|-----------|----------------------------|--------------|---------|---------|---------|--------|--------|------------------------|
| <b>WAN1</b> | <input type="checkbox"/> | BOTH ▾    | 100                        | Mbps ▾ / 100 | Mbps ▾  | 25 %    | 25 %    | 25 %   | 25 %   | <a href="#">Status</a> |
| <b>WAN2</b> | <input type="checkbox"/> | BOTH ▾    | 100                        | Mbps ▾ / 100 | Mbps ▾  | 25 %    | 25 %    | 25 %   | 25 %   | <a href="#">Status</a> |
| <b>WAN3</b> | <input type="checkbox"/> | BOTH ▾    | 100                        | Mbps ▾ / 100 | Mbps ▾  | 25 %    | 25 %    | 25 %   | 25 %   | <a href="#">Status</a> |
| <b>WAN4</b> | <input type="checkbox"/> | BOTH ▾    | 100                        | Mbps ▾ / 100 | Mbps ▾  | 25 %    | 25 %    | 25 %   | 25 %   | <a href="#">Status</a> |
| <b>WAN5</b> | <input type="checkbox"/> | BOTH ▾    | 100                        | Mbps ▾ / 100 | Mbps ▾  | 25 %    | 25 %    | 25 %   | 25 %   | <a href="#">Status</a> |
| <b>WAN6</b> | <input type="checkbox"/> | BOTH ▾    | 100                        | Mbps ▾ / 100 | Mbps ▾  | 25 %    | 25 %    | 25 %   | 25 %   | <a href="#">Status</a> |

Note:

1. QoS may not work properly if the bandwidth entered is not correct. Before enable QoS, you may run speed test (from e.g., <http://speedtest.net>) or contact your ISP for the accurate bandwidth.
2. When Hardware Acceleration enabled, the QoS performance will increase. However, the reserved bandwidth of each class will be fixed, and could not release for others even when not fully used.

### Class Rule

| Index                              | Enable | QoS Class | Local Address | Remote Address | DSCP | Service Type |
|------------------------------------|--------|-----------|---------------|----------------|------|--------------|
| <input type="button" value="Add"/> |        |           |               |                |      |              |

Note:

1. The packets that don't match any class rules above will be classified into 'Others'
2. Go to [User Defined Service Type](#) to edit/delete user-defined service type profiles.

### VoIP Prioritization

Enable the First Priority for VoIP SIP/RTP:

SIP UDP Port:  (Default: 5060) 

### Tag Outbound Traffic

|         |                          |                              |                                        |
|---------|--------------------------|------------------------------|----------------------------------------|
| Class 1 | <input type="checkbox"/> | Add DSCP or Precedence Value | <input type="text" value="Default"/> ▾ |
| Class 2 | <input type="checkbox"/> | Add DSCP or Precedence Value | <input type="text" value="Default"/> ▾ |
| Class 3 | <input type="checkbox"/> | Add DSCP or Precedence Value | <input type="text" value="Default"/> ▾ |

Available settings are explained as follows:

| Item                       | Description                                                                                                                                                                                                                                                                                                                                                                     |
|----------------------------|---------------------------------------------------------------------------------------------------------------------------------------------------------------------------------------------------------------------------------------------------------------------------------------------------------------------------------------------------------------------------------|
| Hardware QoS General Setup | <p>Before using Hardware QoS, enable Hardware Acceleration first.</p> <p>Index - Link of WAN/LAN interface.</p> <p>Enable - Check the box to enable the QoS function for WAN/LAN interface. If it is enabled, you can configure general QoS setting for each interface.</p> <ul style="list-style-type: none"> <li>● Direction - Apply QoS to outgoing traffic only.</li> </ul> |

|                            |                                                                                                                                                                                                                                                                                                                                                                                                                                                                                                                                                                                                                                                                                                                                                                                                                                                                                    |
|----------------------------|------------------------------------------------------------------------------------------------------------------------------------------------------------------------------------------------------------------------------------------------------------------------------------------------------------------------------------------------------------------------------------------------------------------------------------------------------------------------------------------------------------------------------------------------------------------------------------------------------------------------------------------------------------------------------------------------------------------------------------------------------------------------------------------------------------------------------------------------------------------------------------|
|                            | <ul style="list-style-type: none"> <li>● Egress Bandwidth - The outbound bandwidth of the WAN/LAN.</li> <li>● Class 1 ~ 3 / Others - Percentage of bandwidth reserved for each class.</li> <li>● Status - Click to bring up the Online Statistics page that shows snapshots of statistics for the given WAN/LAN interface.</li> </ul>                                                                                                                                                                                                                                                                                                                                                                                                                                                                                                                                              |
| Software QoS General Setup | <p>Index - Link of WAN/LTE interface.</p> <p>Enable - Check the box to enable the QoS function for WAN/LTE interface. If it is enabled, you can configure general QoS setting for each WAN/LTE interface.</p> <ul style="list-style-type: none"> <li>● Direction -Direction of traffic to which QoS is to be applied (Inbound, Outbound, or Both). <ul style="list-style-type: none"> <li>- IN - Apply QoS to incoming traffic only.</li> <li>- OUT - Apply QoS to outgoing traffic only.</li> <li>- BOTH - Apply to both incoming and outgoing traffic.</li> </ul> </li> <li>● Ingress/Egress Bandwidth - The inbound / outbound bandwidth of the WAN.</li> <li>● Class 1 ~ 3 / Others - Percentage of bandwidth reserved for each class.</li> </ul> <p>Status - Click to bring up the Online Statistics page that shows snapshots of statistics for the given WAN interface.</p> |
| Class Rule                 | <p>Define and list the Class rules.</p> <p>Index - Display the class number that you can edit.</p> <p>Enable - Display the status of this class rule.</p> <p>QoS Class - Display the QoS class level.</p> <p>Local Address - Display the local IP address for the rule.</p> <p>Remote Address - Display the remote IP address for the rule.</p> <p>DSCP - Display the levels of the data for processing with QoS control.</p> <p>Service Type - Display detailed settings for the service type.</p> <p>Add - Click it to create a class rule for QoS.</p>                                                                                                                                                                                                                                                                                                                          |
| VoIP Prioritization        | <p>Enable the First Priority for VoIP SIP/RTP - Select to allow VoIP traffic to receive the highest priority.</p> <p>SIP UDP Port - Port number to be monitored for SIP traffic.</p> <p> - Click this icon to display the VoIP QoS Status.</p>                                                                                                                                                                                                                                                                                                                                                                                                                                                                                                                                                  |
| Tag Outbound Traffic       | <p>Tag the outgoing traffic with the DSCP or Precedence value.</p> <p>Add DSCP or Precedence Value for Class 1 to Class 3 - Check to apply the DSCP or precedence value for each class.</p>                                                                                                                                                                                                                                                                                                                                                                                                                                                                                                                                                                                                                                                                                        |

To save changes, click OK; to discard changes, click Cancel.

## Online Statistics

Click the Status link in the General Setup section to show real-time online statistics of the WAN interface.

Bandwidth Management >> Quality of Service

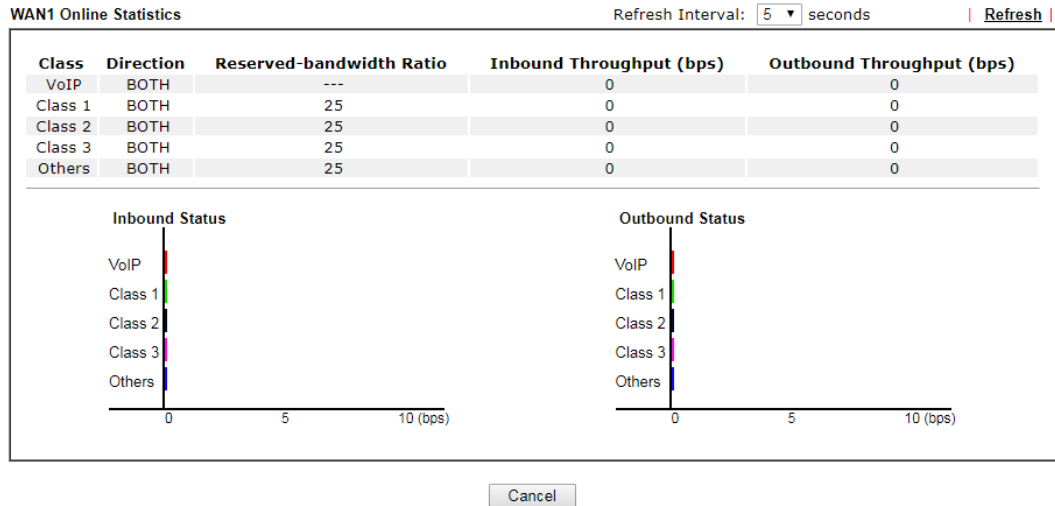

## General Setup for WAN Interface (Software QoS)

Click WAN/LTE interface number link to configure the limited bandwidth ratio for QoS of the WAN interface.

Bandwidth Management >> Quality of Service >> WAN1

Enable UDP Bandwidth Control  
 Limited\_bandwidth Ratio  %

Outbound TCP ACK Prioritize

OK Cancel

Available settings are explained as follows:

| Item                         | Description                                                                                                                                                                                                                                                                |
|------------------------------|----------------------------------------------------------------------------------------------------------------------------------------------------------------------------------------------------------------------------------------------------------------------------|
| Enable UDP Bandwidth Control | Select to restrict the bandwidth available to UDP traffic. The Limited_bandwidth Ratio value is the maximum percentage of bandwidth that can be used by UDP traffic. <ul style="list-style-type: none"> <li>Limited_bandwidth Ratio - Enter a percentage value.</li> </ul> |
| Outbound TCP ACK Prioritize  | Select to give outbound ACK packets priority over other packets to ensure traffic is not slowed down because the remote host is waiting for ACK packets before further traffic will be sent.                                                                               |



### Info

The rate of outbound/inbound must be smaller than the real bandwidth to ensure correct calculation of QoS. It is suggested to set the bandwidth value for inbound/outbound as 80% - 85% of physical network speed provided by ISP to maximize the QoS performance.

## Add / edit a Class Rule for QoS

You can set up to 20 rules for one Class. If you want to edit an existed rule, please select the radio button of that one and click Edit to open the rule edit page for modification.

- To add a rule, click Add to bring up the configuration page. To edit an existing rule, select the rule by clicking the radio button in front of the rule, and then click Edit to bring up the configuration page.

**Class Rule**

| Index | Enable | Qos Class | Local Address | Remote Address | DSCP | Service Type |
|-------|--------|-----------|---------------|----------------|------|--------------|
| Add   |        |           |               |                |      |              |

**Note:**

- The packets that don't match any class rules above will be classified into 'Others'
- Go to [User Defined Service Type](#) to edit/delete user-defined service type profiles.
- Hardware Acceleration will not work on wired WAN interfaces with QoS enabled.

**VoIP Prioritization**

Enable the First Priority for VoIP SIP/RTP: 

SIP UDP Port:  (Default: 5060)

**Tag Outbound Traffic**

|         |                                                       |         |   |
|---------|-------------------------------------------------------|---------|---|
| Class 1 | <input type="checkbox"/> Add DSCP or Precedence Value | Default | ▼ |
| Class 2 | <input type="checkbox"/> Add DSCP or Precedence Value | Default | ▼ |
| Class 3 | <input type="checkbox"/> Add DSCP or Precedence Value | Default | ▼ |

OK Cancel

- For adding a new rule, click Add to open the following page.

Bandwidth Management >> Quality of Service

**Rule 1**

Enable

IP Version:  IPv4  IPv6

Local IP Address:  Edit

Remote IP Address:  Edit

DiffServ CodePoint:  Edit

Service Type:  ▼

QoS Class:  ▼

OK Delete Cancel

Available settings are explained as follows:

| Item              | Description                                                                             |
|-------------------|-----------------------------------------------------------------------------------------|
| Enable            | Select to enable this rule.                                                             |
| IP Version        | Protocol (IPv4 or IPv6) to which this rule applies.                                     |
| Local IP Address  | Click the Edit button to set the local (LAN) IP address or address range for the rule.  |
| Remote IP Address | Click the Edit button to set the remote (WAN) IP address or address range for the rule. |

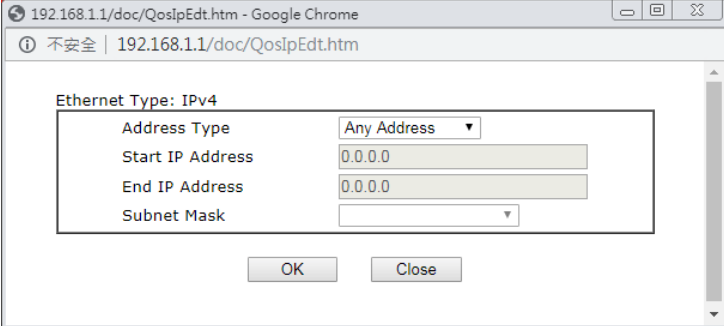
|                    |                                                                                                                                                                                                                                                                                                                                                                                                                              |
|--------------------|------------------------------------------------------------------------------------------------------------------------------------------------------------------------------------------------------------------------------------------------------------------------------------------------------------------------------------------------------------------------------------------------------------------------------|
|                    |  <p>Address Type - Type of address: Any Address, Single Address, Range Address, Subnet Address.</p> <ul style="list-style-type: none"> <li>● Single Address - Specify IP address.</li> <li>● Range Address - Specify Start IP Address and End IP Address.</li> <li>● Subnet Address - Specify Start IP Address and Subnet Mask.</li> </ul> |
| DiffServ CodePoint | DSCP or ToS precedence of packets to which this rule applies.                                                                                                                                                                                                                                                                                                                                                                |
| Service Type       | Service Type to which this rule applies.<br>Service is a predefined or user-defined type of traffic that uses certain protocols or ports. To set up a custom service, select User Defined to set the service name, the protocol, and port number.                                                                                                                                                                            |
| QoS Class          | Specify the QoS class (1, 2 or 3) for this rule.                                                                                                                                                                                                                                                                                                                                                                             |

3. After finishing all the settings here, please click OK to save the configuration.

**Class Rule**

| Index | Enable                              | QoS Class | Local Address | Remote Address | DSCP | Service Type |
|-------|-------------------------------------|-----------|---------------|----------------|------|--------------|
| 1     | <input checked="" type="checkbox"/> | Class1    | Any           | Any            | ANY  | ANY          |

**Note:**

- The packets that don't match any class rules above will be classified into 'Others'
- Go to **User Defined Service Type** to edit/delete user-defined service type profiles.

**VoIP Prioritization**

Enable the First Priority for VoIP SIP/RTP: 

SIP UDP Port:  (Default: 5060)

**Tag Outbound Traffic**

|         |                          |                              |         |
|---------|--------------------------|------------------------------|---------|
| Class 1 | <input type="checkbox"/> | Add DSCP or Precedence Value | Default |
| Class 2 | <input type="checkbox"/> | Add DSCP or Precedence Value | Default |
| Class 3 | <input type="checkbox"/> | Add DSCP or Precedence Value | Default |

### Retag the Packets for Identification

Packets originating from the LAN that are destined for the WAN can have the DS flag changed to a different value by enabling Tag Packet and specifying the DSCP or IP Precedence value.

In the following illustration, outbound VoIP packets from the LAN arrive at the Vigor router with the QoS value unset. The router sets the DSCP value to AF before forwarding them to the ISP server via the WAN interface.

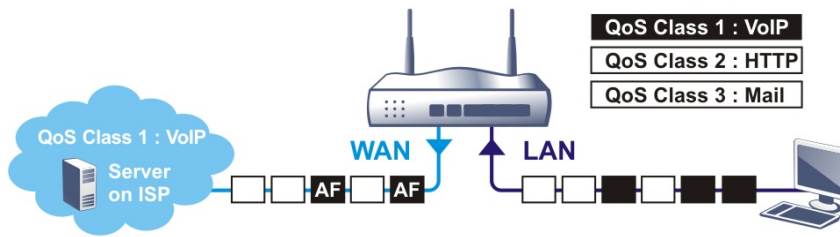

**Class Rule**

| Index | Enable                              | Qos Class | Local Address | Remote Address | DSCP | Service Type  |
|-------|-------------------------------------|-----------|---------------|----------------|------|---------------|
| 1     | <input checked="" type="checkbox"/> | Class 1   | Any           | Any            | ANY  | SIP(UDP:5060) |
| 2     | <input checked="" type="checkbox"/> | Class 1   | Any           | Any            | ANY  | HTTP(TCP:80)  |
| 3     | <input checked="" type="checkbox"/> | Class 1   | Any           | Any            | ANY  | SMTP(TCP:25)  |

**Note:**

1. The packets that don't match any class rules above will be classified into 'Others'
2. Go to **User Defined Service Type** to edit/delete user-defined service type profiles.
3. Hardware Acceleration will not work on wired WAN interfaces with QoS enabled.

**VoIP Prioritization**

**Enable the First Priority for VoIP SIP/RTP:**

SIP UDP Port:  (Default:5060)

**Tag Outbound Traffic**

|         |                                     |                              |                                                      |
|---------|-------------------------------------|------------------------------|------------------------------------------------------|
| Class 1 | <input checked="" type="checkbox"/> | Add DSCP or Precedence Value | <input type="text" value="AF Class1 (Medium Drop)"/> |
| Class 2 | <input checked="" type="checkbox"/> | Add DSCP or Precedence Value | <input type="text" value="AF Class2 (Low Drop)"/>    |
| Class 3 | <input checked="" type="checkbox"/> | Add DSCP or Precedence Value | <input type="text" value="AF Class3 (Medium Drop)"/> |

## VII-2-4 APP QoS

To configure APP QoS, from the main menu, select Bandwidth Management menu, then click APP QoS to bring up the configuration page.

Bandwidth Management >> APP QoS

APP QoS

Enable
  Disable

Traceable
  Untraceable

Apply to all:

| Enable                   | Instant Message    | Version     | Action                                          |
|--------------------------|--------------------|-------------|-------------------------------------------------|
| <input type="checkbox"/> | Facebook/Instagram |             | <input type="text" value="QoS Class 1 (High)"/> |
| <input type="checkbox"/> | LINE               | 5.23.0.2134 | <input type="text" value="QoS Class 1 (High)"/> |
| <input type="checkbox"/> | LinkedIn           |             | <input type="text" value="QoS Class 1 (High)"/> |
| <input type="checkbox"/> | Signal             | 1.26.2      | <input type="text" value="QoS Class 1 (High)"/> |
| <input type="checkbox"/> | Slack              | 4.0.0       | <input type="text" value="QoS Class 1 (High)"/> |
| <input type="checkbox"/> | Snapchat           | 10.79.5.0   | <input type="text" value="QoS Class 1 (High)"/> |
| <input type="checkbox"/> | Telegram           | 1.7.10      | <input type="text" value="QoS Class 1 (High)"/> |
| <input type="checkbox"/> | WhatsApp           | 0.3.2848    | <input type="text" value="QoS Class 1 (High)"/> |

Available settings are explained as follows:

| Item           | Description                                                                                                                                                                                                                                                                                                                                                                                                                              |
|----------------|------------------------------------------------------------------------------------------------------------------------------------------------------------------------------------------------------------------------------------------------------------------------------------------------------------------------------------------------------------------------------------------------------------------------------------------|
| Enable/Disable | Enables or disables the APP QoS feature.                                                                                                                                                                                                                                                                                                                                                                                                 |
| Traceable      | <p>Traceable applications are those whose traffic can be 100% traced.</p> <p>All protocols under this tab can have a specific QoS class assigned.</p> <p>Enable - Select to enable QoS for the application.</p> <p>Apply to all - Select a QoS class to be applied to all protocols. You can override the QoS class for specific protocols using the Action dropdown listbox.</p>                                                        |
| Untraceable    | <p>Untraceable applications are detected when they attempt to establish connections to remote hosts, and all traffic between the remote hosts and the local network will be placed under QoS, within the same QoS class.</p> <p>All protocols under this tab can have a specific QoS class assigned.</p> <p>Enable - Select to enable QoS for the application.</p> <p>Action - Select a QoS class to be applied to all applications.</p> |
| Select All     | Click to select all Enabled checkboxes.                                                                                                                                                                                                                                                                                                                                                                                                  |
| Clear All      | Click to deselect all Enabled checkboxes.                                                                                                                                                                                                                                                                                                                                                                                                |

After changes have been made, click OK to save changes, or Cancel to discard.



---

## VII-3 User Management

User Management allows the network administrator to manage Internet access at the user level. After a user has been authenticated by means of a username and password, he or she can be granted Internet access, and optional firewall rules and WAN access policies can be applied.

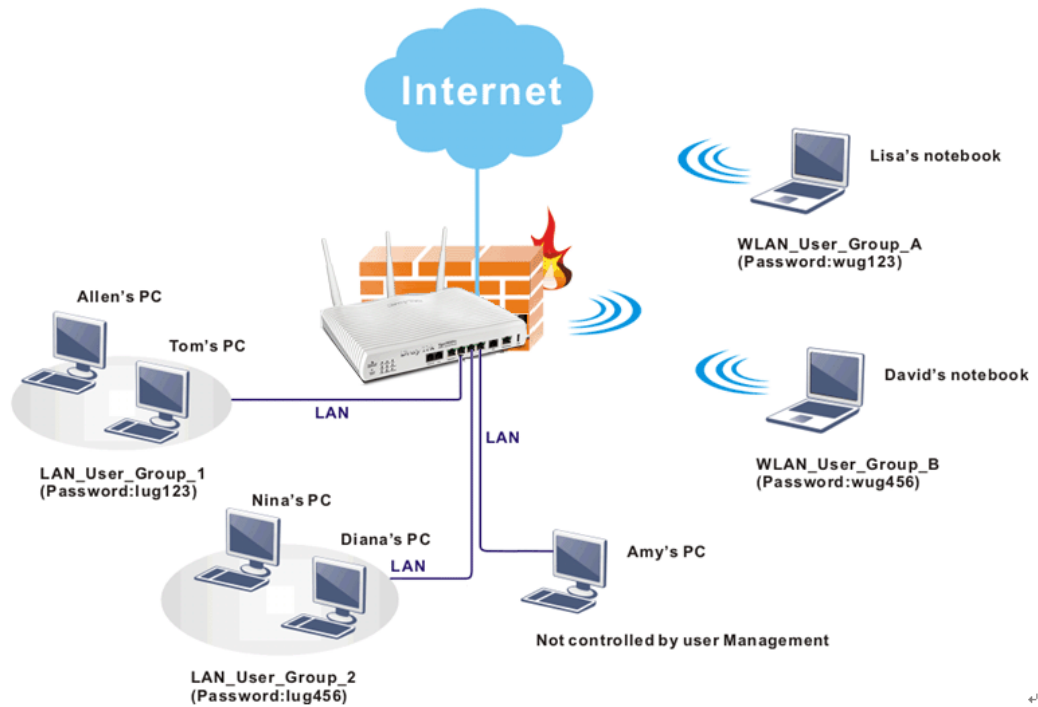

### Info

In general, filter rules configured in the Firewall apply globally. However, in user management, the filter rules can be selectively applied to user profiles.

# Web User Interface

- Firewall
- User Management**
- General Setup
- User Profile
- User Group
- User Online Status
- Objects Setting

## VII-3-1 General Setup

Global settings for User Management can be configured in this section.

User Management >> General Setup

General Setup

**Mode Selection:**

**Rule-Based** is a management method based on IP address. Administrator may set different firewall rules to different IP address.

**User-Based** is a management method based on user profiles. Administrator may set different firewall rules to different user profiles.

**Authentication page:**

Web Authentication:  HTTPS  HTTP

[Login Page Greeting](#)

Display IP address on the dialog box pops up after successful login.

**Landing page:**

(Max 255 characters) [Preview](#) [Set to Factory Default](#)

```
<body stats=1><script language='javascript'>
window.location='http://www.draytek.com'</script></body>
```

OK Clear Cancel

Available settings are explained as follows:

| Item                | Description                                                                                                                                                                                                                                                                                                                                                                                                   |
|---------------------|---------------------------------------------------------------------------------------------------------------------------------------------------------------------------------------------------------------------------------------------------------------------------------------------------------------------------------------------------------------------------------------------------------------|
| Mode Selection      | The User Management Mode.<br>User-Based - Router applies filter rules configured in User Management>>User Profile.<br>Rule-Based - Router applies filter rules configured in Firewall>>General Setup and Filter Rule.                                                                                                                                                                                         |
| Authentication page | Web Authentication - Web protocol for the web authentication page. <ul style="list-style-type: none"> <li>● HTTP - Web page will be unencrypted.</li> <li>● HTTPS - Web page will be encrypted.</li> </ul> <a href="#">Login Page Greeting</a> - Click to be redirected to System Maintenance >> Login Page Greeting, where you can configure the message that is shown to the user after a successful login. |

|              |                                                                                                                |
|--------------|----------------------------------------------------------------------------------------------------------------|
|              | Display IP Address on tracking window - Select to display the IP address of the client on the tracking window. |
| Landing Page | HTML code to be shown on the Login Page Greeting.                                                              |

Click OK to save changes, Clear to restore settings to factory defaults, or Cancel to discard changes.

## VII-3-2 User Profile

This page allows you to create up to 200 user profiles for use with User Management.

Select User Management>>User Profile from the menu bar, then click a profile number to configure.

User Management >> User Profile

| User Profile Table  |                                     |              | <a href="#">Set to Factory Default</a> |                          |      |
|---------------------|-------------------------------------|--------------|----------------------------------------|--------------------------|------|
| Select All          |                                     | Clear All    |                                        | Search                   |      |
| Profile             | Enable                              | Name         | Profile                                | Enable                   | Name |
| <a href="#">1.</a>  | <input checked="" type="checkbox"/> | admin        | <a href="#">17.</a>                    | <input type="checkbox"/> |      |
| <a href="#">2.</a>  | <input checked="" type="checkbox"/> | Dial-In User | <a href="#">18.</a>                    | <input type="checkbox"/> |      |
| <a href="#">3.</a>  | <input type="checkbox"/>            |              | <a href="#">19.</a>                    | <input type="checkbox"/> |      |
| <a href="#">4.</a>  | <input type="checkbox"/>            |              | <a href="#">20.</a>                    | <input type="checkbox"/> |      |
| <a href="#">5.</a>  | <input type="checkbox"/>            |              | <a href="#">21.</a>                    | <input type="checkbox"/> |      |
| <a href="#">6.</a>  | <input type="checkbox"/>            |              | <a href="#">22.</a>                    | <input type="checkbox"/> |      |
| <a href="#">7.</a>  | <input type="checkbox"/>            |              | <a href="#">23.</a>                    | <input type="checkbox"/> |      |
| <a href="#">8.</a>  | <input type="checkbox"/>            |              | <a href="#">24.</a>                    | <input type="checkbox"/> |      |
| <a href="#">9.</a>  | <input type="checkbox"/>            |              | <a href="#">25.</a>                    | <input type="checkbox"/> |      |
| <a href="#">10.</a> | <input type="checkbox"/>            |              | <a href="#">26.</a>                    | <input type="checkbox"/> |      |
| <a href="#">11.</a> | <input type="checkbox"/>            |              | <a href="#">27.</a>                    | <input type="checkbox"/> |      |
| <a href="#">12.</a> | <input type="checkbox"/>            |              | <a href="#">28.</a>                    | <input type="checkbox"/> |      |
| <a href="#">13.</a> | <input type="checkbox"/>            |              | <a href="#">29.</a>                    | <input type="checkbox"/> |      |
| <a href="#">14.</a> | <input type="checkbox"/>            |              | <a href="#">30.</a>                    | <input type="checkbox"/> |      |
| <a href="#">15.</a> | <input type="checkbox"/>            |              | <a href="#">31.</a>                    | <input type="checkbox"/> |      |
| <a href="#">16.</a> | <input type="checkbox"/>            |              | <a href="#">32.</a>                    | <input type="checkbox"/> |      |

<< [1-32](#) | [33-64](#) | [65-96](#) | [97-128](#) | [129-160](#) | [161-192](#) | [193-200](#) >> [Next](#) >>

**Note:**

1. admin: To change the administrator password, please go to System Maintenance >> Administrator Password.
2. Dial-In User Profile: Dial-In User Profile is reserved for VPN authentication.
3. During authentication, Router will check all the local user profiles first, and then the profiles in external servers.

OK      Cancel

Profiles 1 (admin) and 2 (Dial-In User) are reserved profiles. The admin profile applies to the router administrator login, while the Dial-in User profile applies to all VPN dial-in users.

Profile Index 3

Common Settings

|                                                         |                                            |
|---------------------------------------------------------|--------------------------------------------|
| <input checked="" type="checkbox"/> Enable this account |                                            |
| Username                                                | marketing (Only support A-Z a-z 0-9 - . @) |
| Password                                                | *****                                      |
| Confirm Password                                        | *****                                      |
| External Server Authentication                          | None                                       |

Login Settings

|                               |                                                                                                                                   |
|-------------------------------|-----------------------------------------------------------------------------------------------------------------------------------|
| Allow Authentication via      | <input checked="" type="checkbox"/> Web <input checked="" type="checkbox"/> Alert Tool <input checked="" type="checkbox"/> Telnet |
| Show Landing Page After Login | <input type="checkbox"/>                                                                                                          |
| Idle Timeout                  | 10 min. (0: Unlimited)                                                                                                            |
| Auto Logout After             | 0 min. (0: Off)                                                                                                                   |
| Pop up Time-Tracking Window   | <input checked="" type="checkbox"/>                                                                                               |
| Login Permission Schedule     | None, None, None, None                                                                                                            |

Policy

|                                                       |                                                                                                               |
|-------------------------------------------------------|---------------------------------------------------------------------------------------------------------------|
| Max. Login Devices                                    | 0 (0: Unlimited)                                                                                              |
| <input type="checkbox"/> Enable Time Quota            | 0 min. - 0 +                                                                                                  |
| <input type="checkbox"/> Enable Data Quota            | 0 MB - 0 +                                                                                                    |
| <input type="checkbox"/> Reset Quota Automatically To | Time Limit 0 min. Data Limit 0 MB                                                                             |
| When                                                  | <input checked="" type="radio"/> Login Permission Schedule Ends<br><input type="radio"/> Schedule None Starts |

Other Services

|                                  |                                                                                |
|----------------------------------|--------------------------------------------------------------------------------|
| Allow this profile to be used by | <input type="checkbox"/> Internal RADIUS <input type="checkbox"/> Local 802.1X |
| Log                              | None                                                                           |

OK Refresh Clear Cancel

Available settings are explained as follows:

| Item                            | Description                                                                                                                                                                                                                                                                                                                                             |
|---------------------------------|---------------------------------------------------------------------------------------------------------------------------------------------------------------------------------------------------------------------------------------------------------------------------------------------------------------------------------------------------------|
| <b>Common Settings</b>          |                                                                                                                                                                                                                                                                                                                                                         |
| Enable this account             | Select to enable this user profile.                                                                                                                                                                                                                                                                                                                     |
| Username                        | Login name (e.g., LAN_User_Group_1, WLAN_User_Group_A, WLAN_User_Group_B, etc.) for this user profile. Maximum length is 24 characters.                                                                                                                                                                                                                 |
| Password                        | Password (e.g., lug123, wug123, wug456, etc.) for this user profile. Maximum length is 24 characters.<br>When a user tries to access the Internet and User Management is enabled, he or she must supply a valid user name and password combination for authentication. The profile with matching user name and password will be applied to the session. |
| Confirm Password                | Enter the password again for confirmation.                                                                                                                                                                                                                                                                                                              |
| External Service Authentication | The router will authenticate dial-in users using either a built-in (None) or external service (LDAP, Radius or TACACS+). The Password setting is ignored when an external authentication service is used.                                                                                                                                               |
| <b>Login Settings</b>           |                                                                                                                                                                                                                                                                                                                                                         |

|                               |                                                                                                                                                                                                                                                                                                                                                                                                                                                                                                                                                                                                                                                                                         |
|-------------------------------|-----------------------------------------------------------------------------------------------------------------------------------------------------------------------------------------------------------------------------------------------------------------------------------------------------------------------------------------------------------------------------------------------------------------------------------------------------------------------------------------------------------------------------------------------------------------------------------------------------------------------------------------------------------------------------------------|
| Allow Authentication via      | <p>The authentication methods allowed for this user.</p> <p><b>Web</b> - If selected, user will need to authenticate by entering a username and password when attempting to access an external website for the first time. The user will be redirected to the external website after a successful authentication.</p> <p><b>Alert Tool</b> - If selected, the user can enter the user name and password into the DrayTek Alert Tool. A window with remaining time of connection for such user will be displayed. The Alter Tool can be downloaded from the DrayTek website.</p> <p><b>Telnet</b> - If selected, the user can authenticate by logging in to the router using telnet.</p> |
| Show Landing Page After Login | <p>When a user tries to access into the web user interface of Vigor router series with the user name and password specified in this profile, he/she will be lead into the web page configured in Landing Page field in User Management&gt;&gt;General Setup.</p> <p>Check this box to enable such function.</p>                                                                                                                                                                                                                                                                                                                                                                         |
| Idle Timeout                  | <p>If there is no WAN traffic to and from the LAN client for the specified amount of time (in minutes), the WAN session is reset and the user will need to re-authenticate before Internet access is once again allowed. The default Idle Timeout value is 10 minutes.</p>                                                                                                                                                                                                                                                                                                                                                                                                              |
| Auto Logout After             | <p>Such account will be forced to logout after a certain time set here.</p>                                                                                                                                                                                                                                                                                                                                                                                                                                                                                                                                                                                                             |
| Pop up Time-Tracking Window   | <p>If enabled, a browser window will pop up showing the session time remaining. However, the system will update the time periodically to keep the connection always on. Thus, Idle Timeout will not interrupt the network connection.</p>                                                                                                                                                                                                                                                                                                                                                                                                                                               |
| Login Permission Schedule     | <p>You can enter four sets of time schedule for your request. All the schedules can be set previously in Applications &gt;&gt; Schedule web page and you can use the number that you have set in that web page.</p>                                                                                                                                                                                                                                                                                                                                                                                                                                                                     |
| <b>Policy</b>                 |                                                                                                                                                                                                                                                                                                                                                                                                                                                                                                                                                                                                                                                                                         |
| Max. Login Devices            | <p>The maximum number of concurrent logins allowed for this profile. The default setting is 0 which means no limit.</p>                                                                                                                                                                                                                                                                                                                                                                                                                                                                                                                                                                 |
| Enable Time Quota             | <p>If selected, the user is allowed Internet access for the specified amount of time after a successful authentication. The first value is the remaining time of the current login session, whereas the second value is the value to increment or decrement from the remaining time quota by clicking + /- buttons. Both values are in minutes.</p> <p>Click + / - to increase / decrease the time quota for such profile.</p> <div style="border: 1px solid black; padding: 5px; margin-top: 10px;"> <p><b>Note:</b> A dialog will be popped up showing the remaining time remained when the user after the user has successfully authenticated.</p> </div>                            |

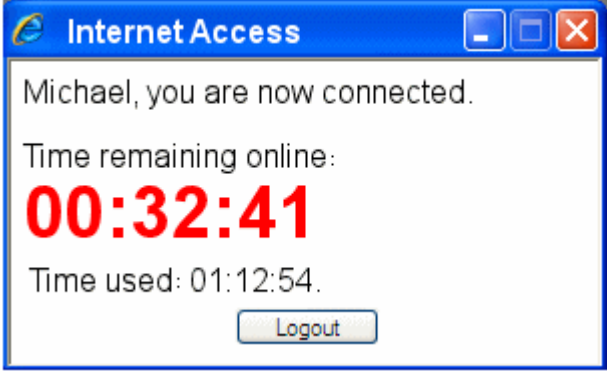
|                                                |                                                                                                                                                                                                                                                                                                                                                                                                                                                                                                              |
|------------------------------------------------|--------------------------------------------------------------------------------------------------------------------------------------------------------------------------------------------------------------------------------------------------------------------------------------------------------------------------------------------------------------------------------------------------------------------------------------------------------------------------------------------------------------|
|                                                |  <p>When the time is up, all Internet connections are terminated.</p>                                                                                                                                                                                                                                                                                                                                                      |
| <p><b>Enable Data Quota</b></p>                | <p>If selected, the user is allowed to use the specified amount of data after a successful authentication.</p> <p>The first value is the remaining data quota of the current login session, whereas the second value is the value to increment or decrement from the remaining data quota by clicking +/- buttons. The unit for both values can be set to either MB (megabytes) or GB (gigabytes) using the MB/GB dropdown box.</p> <p>Click +/- to increase / decrease the data quota for such profile.</p> |
| <p><b>Reset quota automatically</b></p>        | <p>Select to enable this option.</p> <p>Reset the time and data quotas to the preset default values when a time schedule ends.</p> <p>Time Limit - Enter value for default time quota.</p> <p>Data Limit - Enter value for default data quota.</p> <p>Login Permission Schedule Ends - When the scheduling time is up, the router will reset the quota with user-defined time/data values automatically.</p> <p><u>Schedule</u> - Specify a time schedule index number for this profile.</p>                 |
| <p><b>Other Services</b></p>                   |                                                                                                                                                                                                                                                                                                                                                                                                                                                                                                              |
| <p><b>Allow this profile to be used by</b></p> | <p>This option is available for profiles with index number 3 to 200.</p> <p>Internal RADIUS- Check the box to enable security authenticated via internal RADIUS server.</p> <p>Local 802.1X - Check the box to enable security authenticated via internal 802.1X server.</p>                                                                                                                                                                                                                                 |
| <p><b>Log</b></p>                              | <p>Activities of the user can be recorded by Syslog.</p> <p>None - Logging is disabled.</p> <p>Login - Login and logout activities are logged.</p> <p>Event - Allowed and blocked traffic are logged.</p> <p>All - Both Login and Event types are logged.</p>                                                                                                                                                                                                                                                |

Click OK to save changes, Clear to restore settings to factory defaults, or Cancel to discard changes. Click Refresh to reload the page with the most recent data usage information (data and time quotas).

## VII-3-3 User Group

This page allows you to place multiple user profiles into groups. These groups can be used to set up filter rules in Firewall>>General Setup.

User Management >> User Group

User Group Table: | [Set to Factory Default](#) |

| Index               | Name | Index               | Name |
|---------------------|------|---------------------|------|
| <a href="#">1.</a>  |      | <a href="#">17.</a> |      |
| <a href="#">2.</a>  |      | <a href="#">18.</a> |      |
| <a href="#">3.</a>  |      | <a href="#">19.</a> |      |
| <a href="#">4.</a>  |      | <a href="#">20.</a> |      |
| <a href="#">5.</a>  |      | <a href="#">21.</a> |      |
| <a href="#">6.</a>  |      | <a href="#">22.</a> |      |
| <a href="#">7.</a>  |      | <a href="#">23.</a> |      |
| <a href="#">8.</a>  |      | <a href="#">24.</a> |      |
| <a href="#">9.</a>  |      | <a href="#">25.</a> |      |
| <a href="#">10.</a> |      | <a href="#">26.</a> |      |
| <a href="#">11.</a> |      | <a href="#">27.</a> |      |
| <a href="#">12.</a> |      | <a href="#">28.</a> |      |
| <a href="#">13.</a> |      | <a href="#">29.</a> |      |
| <a href="#">14.</a> |      | <a href="#">30.</a> |      |
| <a href="#">15.</a> |      | <a href="#">31.</a> |      |
| <a href="#">16.</a> |      | <a href="#">32.</a> |      |

Click an index number link to its setup page:

User Management >> User Group

Group Index : 1

Name:

**Available User Objects**

- 1-admin
- 2-Dial-In User
- 3-test\_1
- 4-marketing

>>



<<

**Selected User Objects (Up to 32)**

-

Available settings are explained as follows:

| Item                   | Description                                                                    |
|------------------------|--------------------------------------------------------------------------------|
| Name                   | Name that identifies this user group.                                          |
| Available User Objects | Shows a list of User Objects that have not been placed into the current group. |

|                                                                                                                                                                        |                                                                                                                                                                                                                                                                                                                                                                     |
|------------------------------------------------------------------------------------------------------------------------------------------------------------------------|---------------------------------------------------------------------------------------------------------------------------------------------------------------------------------------------------------------------------------------------------------------------------------------------------------------------------------------------------------------------|
| <br> | <p>Click &gt;&gt; to move selected user objects in the Available User Objects on the left to the Selected User Objects on the right, thus adding them to the current group.</p> <p>Click &lt;&lt; to move selected user objects in the Selected User Objects on the right to the Available User Objects on the left, thus removing them from the current group.</p> |
| Selected Keyword Objects                                                                                                                                               | Shows a list of User Objects that have been placed into the current group.                                                                                                                                                                                                                                                                                          |

To save changes on the page, click OK. To discard changes, click Cancel. To remove all user objects from the current group, click Clear.

## VII-3-4 User Online Status

This page displays the users that are currently logged into the router. The list refreshes periodically to show the most up-to-date information.

User Management >> User Online Status

Current Time : 09-08 07:46:39      Refresh Seconds:     Page:     | [All Users](#) | [Online Users](#) | [Refresh](#) |

| Index | User                  | IP Address    | Profile               | Last Login Time | Expired Time | Data Quota | Idle Time | Action                                                              |
|-------|-----------------------|---------------|-----------------------|-----------------|--------------|------------|-----------|---------------------------------------------------------------------|
| 1     | <a href="#">admin</a> | 192.168.27.16 | <a href="#">admin</a> | 09-08 03:59:38  | Unlimited    | Unlimited  | Unlimited | <a href="#">Block</a> <a href="#">Logout</a> <a href="#">Delete</a> |
|       |                       |               |                       |                 |              |            |           |                                                                     |
|       |                       |               |                       |                 |              |            |           |                                                                     |
|       |                       |               |                       |                 |              |            |           |                                                                     |
|       |                       |               |                       |                 |              |            |           |                                                                     |
|       |                       |               |                       |                 |              |            |           |                                                                     |
|       |                       |               |                       |                 |              |            |           |                                                                     |
|       |                       |               |                       |                 |              |            |           |                                                                     |
|       |                       |               |                       |                 |              |            |           |                                                                     |
|       |                       |               |                       |                 |              |            |           |                                                                     |
|       |                       |               |                       |                 |              |            |           |                                                                     |
|       |                       |               |                       |                 |              |            |           |                                                                     |
|       |                       |               |                       |                 |              |            |           |                                                                     |
|       |                       |               |                       |                 |              |            |           |                                                                     |
|       |                       |               |                       |                 |              |            |           |                                                                     |
|       |                       |               |                       |                 |              |            |           |                                                                     |
|       |                       |               |                       |                 |              |            |           |                                                                     |
|       |                       |               |                       |                 |              |            |           |                                                                     |
|       |                       |               |                       |                 |              |            |           |                                                                     |
|       |                       |               |                       |                 |              |            |           |                                                                     |
|       |                       |               |                       |                 |              |            |           |                                                                     |
|       |                       |               |                       |                 |              |            |           |                                                                     |
|       |                       |               |                       |                 |              |            |           |                                                                     |

**Note:**

1. Please click "IP Address" to view all online users.
2. Dial-in User profiles are linked to VPN clients and therefore cannot be logged-out or deleted while connecting.
3. Information about 802.1X authentication can be found at [Authentication User List](#).

Total Number : 1

Available settings are explained as follows:

| Item            | Description                                                                                                                                                                                                                                                              |
|-----------------|--------------------------------------------------------------------------------------------------------------------------------------------------------------------------------------------------------------------------------------------------------------------------|
| Refresh Seconds | The time interval between automatic screen refreshes, in seconds. Select one of 10, 15 and 30 seconds.                                                                                                                                                                   |
| Refresh         | Click to manually refresh the displayed data.                                                                                                                                                                                                                            |
| Index           | Index of the user entry.                                                                                                                                                                                                                                                 |
| User            | The name of the user that is logged on. Clicking this will bring up the following page which allows setting time and data quotas of the user.<br>For details, refer to the description on the Enable Time Quota and Enable Data Quota items in the User Profile section. |
| IP Address      | IP LAN address of the device that initiated the login.                                                                                                                                                                                                                   |
| Profile         | Name of the user profile. If the logged-in user is a VPN user, Dial-in User will be displayed. Otherwise it will be the same as User.                                                                                                                                    |



|                 |                                                                                                                                                                                                                               |
|-----------------|-------------------------------------------------------------------------------------------------------------------------------------------------------------------------------------------------------------------------------|
| Last Login Time | The most recent login time of the user.                                                                                                                                                                                       |
| Expired Time    | The expiration time of the current login session.                                                                                                                                                                             |
| Data Quota      | Display the quota for data transmission.<br>The remaining data quota of this login session.                                                                                                                                   |
| Idle Time       | Amount of time the session has been idled.                                                                                                                                                                                    |
| Action          | Block - Stops user from accessing the Internet.<br>Unblock -Resumes Internet access of a blocked user.<br>Logout - Terminates the current login session.<br>Delete - Removes the user entry from the User Online Status page. |

# Application Notes

## A-1 How to authenticate clients via User Management

Before using the function of User Management, please make sure User-Based has been selected as the Mode in the User Management>>General Setup page.

User Management >> General Setup

---

General Setup

**Mode Selection:**

**Rule-Based** is a management method based on IP address. Administrator may set different firewall rules to different IP address.

**User-Based** is a management method based on user profiles. Administrator may set different firewall rules to different user profiles.

**Authentication page:**

Web Authentication:  HTTPS  HTTP

Login Page Greeting

Display IP address on the dialog box pops up after successful login.

With User Management authentication function, before a valid username and password have been correctly supplied, a particular client will not be allowed to access Internet through the router. There are three ways for authentication: Web, Telnet and Alert Tool.

User Management >>User Profile

---

Profile Index 3

Common Settings

Enable this account

Username  (Only support A-Z a-z 0-9 - . @)

Password

Confirm Password

External Server Authentication

Login Settings

Allow Authentication via  Web  Alert Tool  Telnet

Show Landing Page After Login

Idle Timeout  min. (0: Unlimited)

Auto Logout After  min. (0: Off)

Pop up Time-Tracking Window

Login Permission Schedule  ,  ,  ,

### Authentication via Web

- If a LAN client who hasn't passed the authentication opens an external web site in his browser, he will be redirected to the router's Web authentication interface first. Then, the client is trying to access <http://www.draytek.com> and but brought to the Vigor router. Since this is an SSL connection, some web browsers will display warning messages.
  - With Microsoft Internet Explorer, you may get the following warning message. Please press Continue to this website (not recommended).

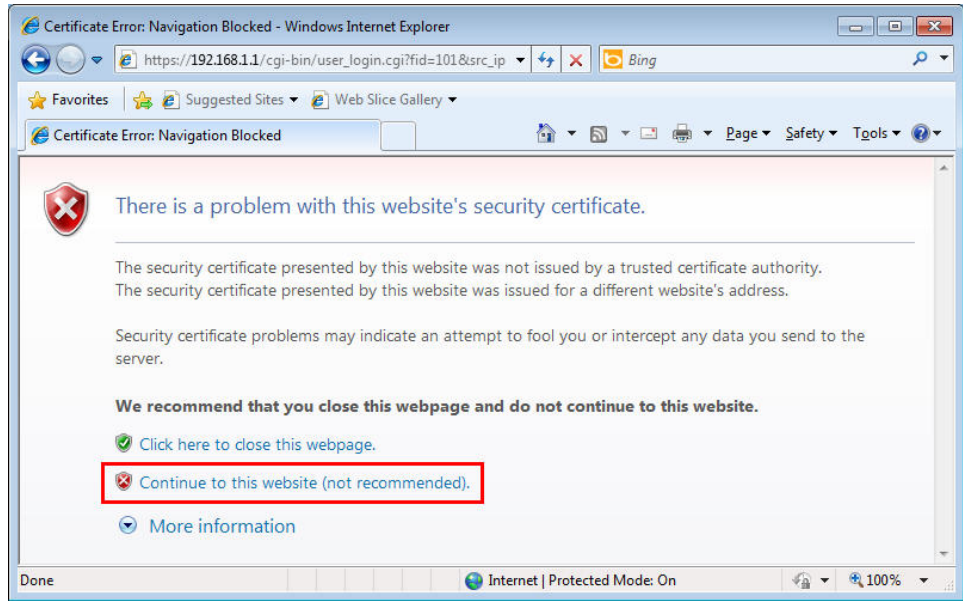

- With Mozilla Firefox, you may get the following warning message. Select **I Understand the Risks**.

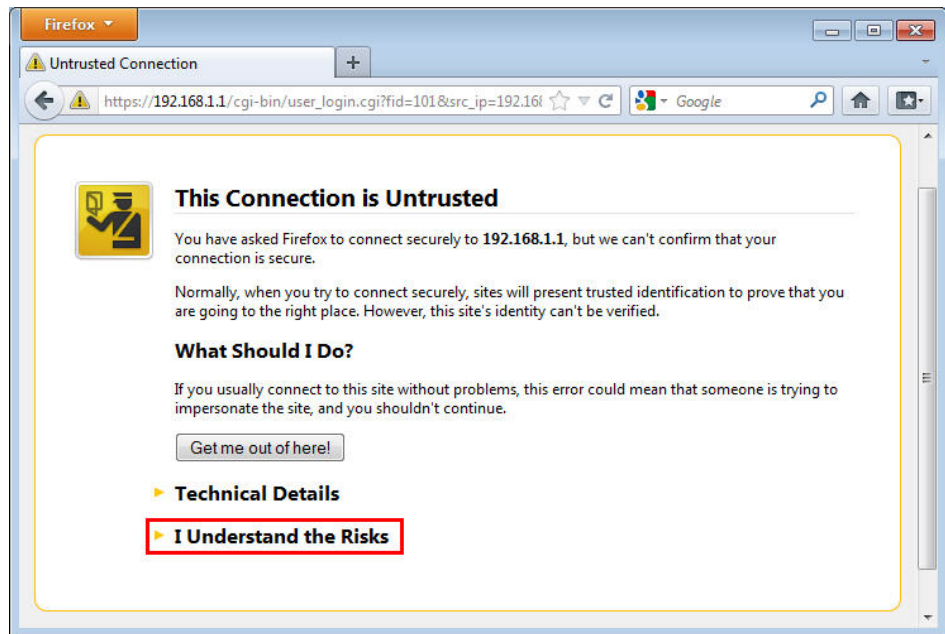

- With Chrome browser, you may get the following warning. Click Proceed anyway.

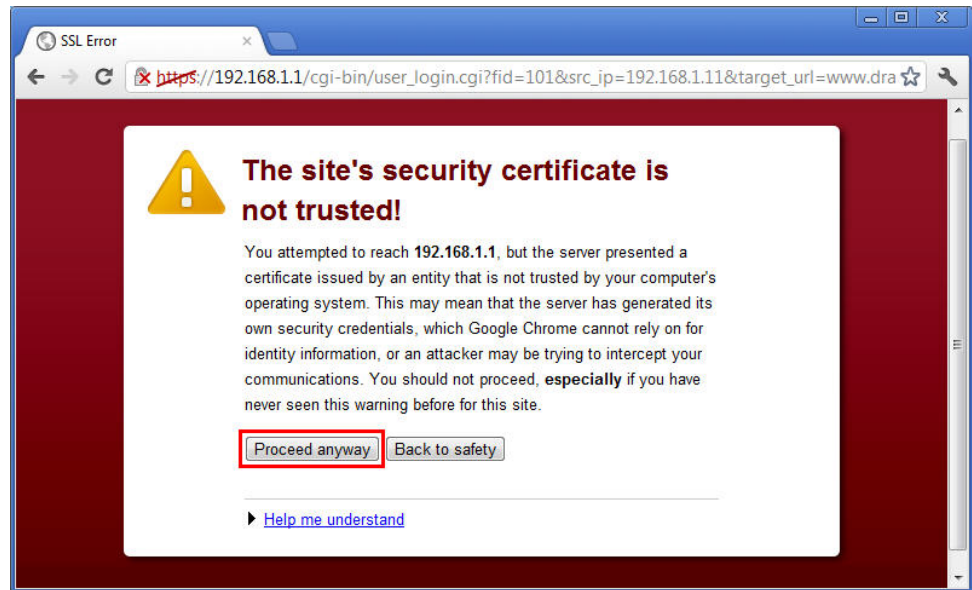

After that, the web authentication window will appear. Input the user name and the password for your account (defined in User Management) and click Login.

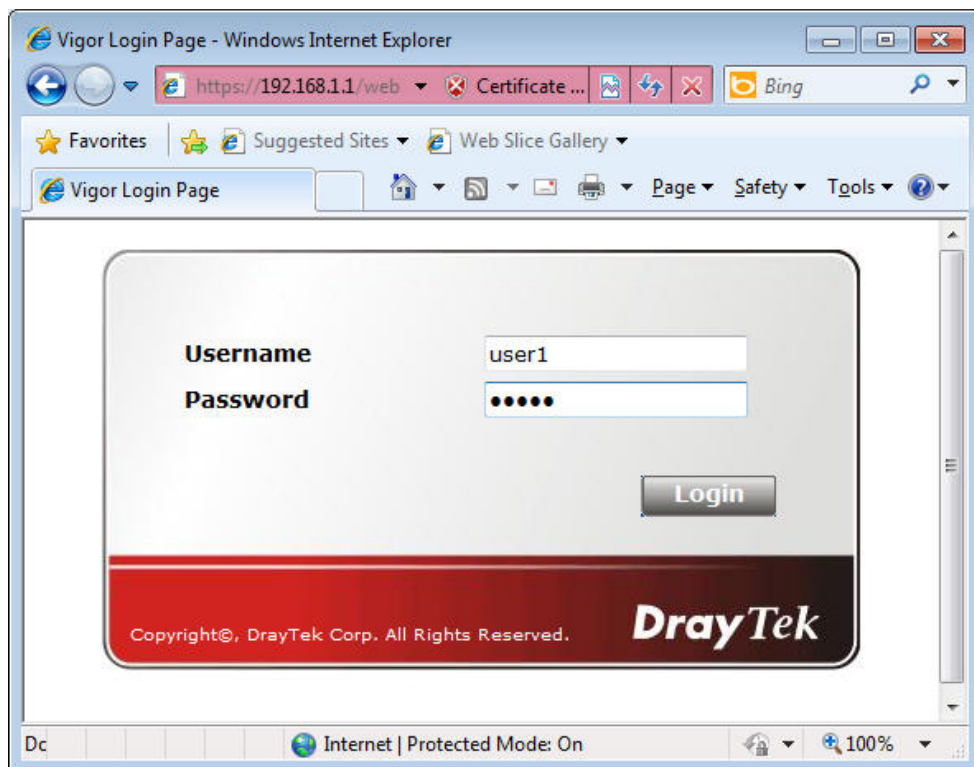

If the authentication is successful, the client will be redirected to the original web site that he tried to access. In this example, it is <http://www.draytek.com>. Furthermore, you will get a popped up window as the following. Then you can access the Internet.

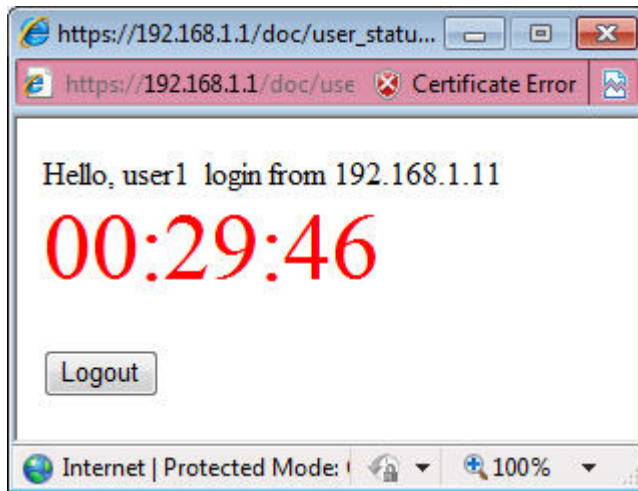

Note, if you block the web browser to pop up any window, you will not see such window. If the authentication is failed, you will get the error message, The username or password you entered is incorrect. Please login again.

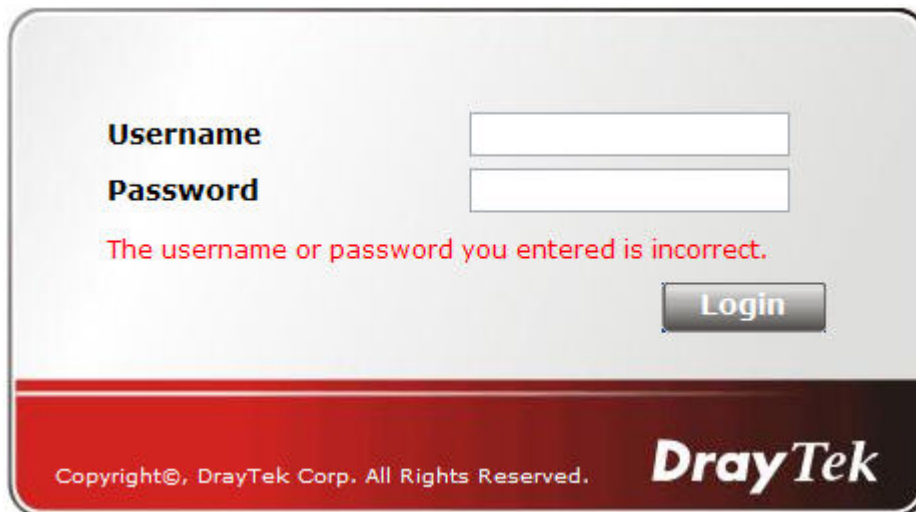

- In above description, you access an external web site to trigger the authentication. You may also directly access the router's Web UI for authentication. Both HTTP and HTTPS are supported, for example <http://192.168.1.1> or <https://192.168.1.1> . Replace 192.168.1.1 with your router's real IP address, and add the port number if the default management port has been modified.

If the authentication is successful, you will get the Welcome Message that is set in the User Management >> General Setup page.

**General Setup**

**Mode Selection:**

**Rule-Based** is a management method based on IP address. Administrator may set different firewall rules to different IP address.

**User-Based** is a management method based on user profiles. Administrator may set different firewall rules to different user profiles.

**Authentication page:**

Web Authentication:  HTTPS  HTTP

**Login Page Greeting**

Display IP address on the dialog box pops up after successful login.

**Landing page:**

(Max 255 characters) Preview | Set to Factory Default |

```
<body stats=1><script language='javascript'>
window.location='http://www.draytek.com'</script></body>
```

With the default setup `<body stats=1><script language='javascript'>window.location='http://www.draytek.com'</script></body>`, you will be redirected to `http://www.draytek.com`. You may change it if you want. For example, you will get the following welcome message if you enter Login Successful in the Welcome Message table.

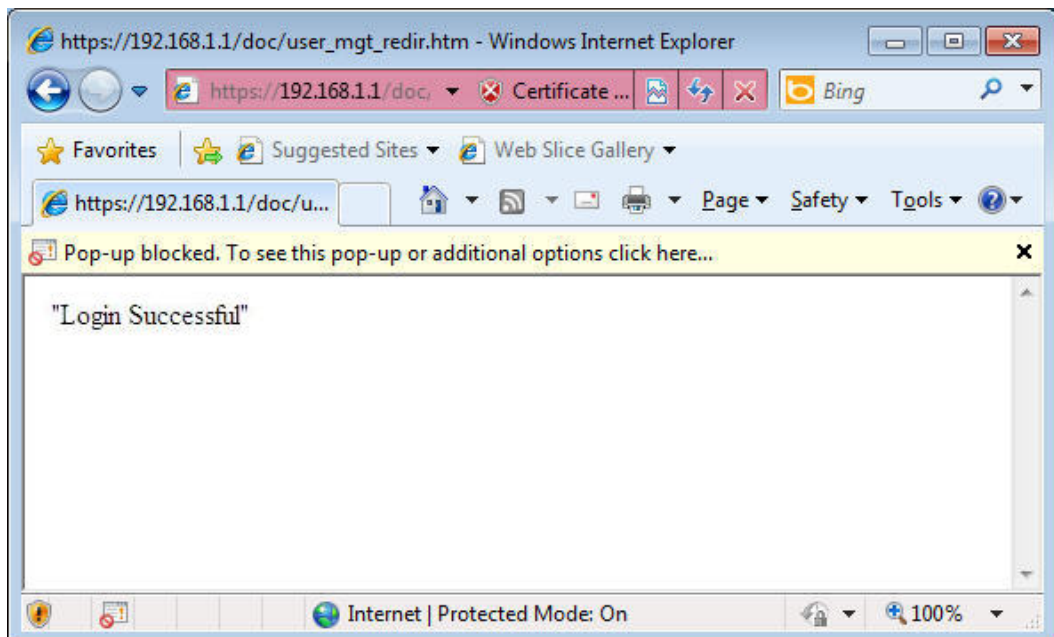

Also you will get a Tracking Window if you don't block the pop-up window.

- Don't setup a user profile in User Management and a VPN Remote Dial-in user profile with the same Username. Otherwise, you may get unexpected result. It is because the VPN Remote Dial-in User profiles can be extended to the User profiles in User Management for authentication.

There are two different behaviors when a User Management account and a VPN profile share the same Username:

- If SSL Tunnel or SSL Web Proxy is enabled in the VPN profile, the user profile in User Management will always be invalid for Web authentication. For example, if

you create a user profile in User Management with chaochen/test as username/password, while a VPN Remote Dial-in user profile with the same username “chaochen” but a different password “1234”, you will always get error message The username or password you entered is incorrect when you use chaochen/test via Web to do authentication.

VPN and Remote Access >> Remote Dial-in User

Index No. 1

|                                                                                                                                                                                                                                                                                                                                                                                                                                                                                                                                                                                                                                                                                                                                                                                                                                                                                                                                                                                                                                                                                                                                                                                                                                              |                                                                                                                                                                                                                                                                                                                                                                                                                                                                                                                                                                                                                                                                                                                                                                                                                                                                                  |
|----------------------------------------------------------------------------------------------------------------------------------------------------------------------------------------------------------------------------------------------------------------------------------------------------------------------------------------------------------------------------------------------------------------------------------------------------------------------------------------------------------------------------------------------------------------------------------------------------------------------------------------------------------------------------------------------------------------------------------------------------------------------------------------------------------------------------------------------------------------------------------------------------------------------------------------------------------------------------------------------------------------------------------------------------------------------------------------------------------------------------------------------------------------------------------------------------------------------------------------------|----------------------------------------------------------------------------------------------------------------------------------------------------------------------------------------------------------------------------------------------------------------------------------------------------------------------------------------------------------------------------------------------------------------------------------------------------------------------------------------------------------------------------------------------------------------------------------------------------------------------------------------------------------------------------------------------------------------------------------------------------------------------------------------------------------------------------------------------------------------------------------|
| <p><b>User account and Authentication</b></p> <p><input checked="" type="checkbox"/> Enable this account</p> <p>Idle Timeout <input type="text" value="300"/> second(s)</p> <p><b>Allowed Dial-In Type</b></p> <p><input type="checkbox"/> PPTP</p> <p><input checked="" type="checkbox"/> IPsec Tunnel</p> <p><input checked="" type="checkbox"/> IKEv1/IKEv2 <input checked="" type="checkbox"/> IKEv2 EAP <input checked="" type="checkbox"/> IPsec XAuth</p> <p><input checked="" type="checkbox"/> L2TP with IPsec Policy <input type="text" value="None"/></p> <p><input checked="" type="checkbox"/> SSL Tunnel</p> <p><input checked="" type="checkbox"/> OpenVPN Tunnel</p> <p><input type="checkbox"/> Specify Remote Node</p> <p>Remote Client IP <input type="text"/></p> <p>or Peer ID <input type="text"/></p> <p>Netbios Naming Packet <input checked="" type="radio"/> Pass <input type="radio"/> Block</p> <p>Multicast via VPN <input type="radio"/> Pass <input checked="" type="radio"/> Block<br/>(for some IGMP, IP-Camera, DHCP Relay...etc.)</p> <p><b>Subnet</b></p> <p><input type="text" value="LAN 1"/></p> <p><input type="checkbox"/> Assign Static IP Address</p> <p><input type="text" value="0.0.0.0"/></p> | <p>Username <input type="text" value="???"/> Max: 19 characters</p> <p>Password <input type="text" value="Max: 19 characters"/></p> <p><input type="checkbox"/> Enable Mobile One-Time Passwords(mOTP)</p> <p>PIN <input type="text"/></p> <p>Code <input type="text"/></p> <p>Secret <input type="text"/></p> <p><b>IKE Authentication Method</b></p> <p><input checked="" type="checkbox"/> Pre-Shared Key</p> <p>IKE Pre-Shared Key <input type="text" value="Max: 64 characters"/></p> <p><input type="checkbox"/> Digital Signature(X.509)</p> <p><input type="text" value="None"/></p> <p><b>IPsec Security Method</b></p> <p><input checked="" type="checkbox"/> Medium(AH)</p> <p>High(ESP) <input checked="" type="checkbox"/> DES <input checked="" type="checkbox"/> 3DES <input checked="" type="checkbox"/> AES</p> <p>Local ID (optional) <input type="text"/></p> |
|----------------------------------------------------------------------------------------------------------------------------------------------------------------------------------------------------------------------------------------------------------------------------------------------------------------------------------------------------------------------------------------------------------------------------------------------------------------------------------------------------------------------------------------------------------------------------------------------------------------------------------------------------------------------------------------------------------------------------------------------------------------------------------------------------------------------------------------------------------------------------------------------------------------------------------------------------------------------------------------------------------------------------------------------------------------------------------------------------------------------------------------------------------------------------------------------------------------------------------------------|----------------------------------------------------------------------------------------------------------------------------------------------------------------------------------------------------------------------------------------------------------------------------------------------------------------------------------------------------------------------------------------------------------------------------------------------------------------------------------------------------------------------------------------------------------------------------------------------------------------------------------------------------------------------------------------------------------------------------------------------------------------------------------------------------------------------------------------------------------------------------------|

**Note:**

1. Username can not contain characters ' \' and \\. .
2. OpenVPN tunnel does not support mOTP.

- If SSL Tunnel or SSL Web Proxy is disabled in the VPN profile, a User Management account and a remote dial-in VPN profile can use the same Username, even with different passwords. However, we recommend you to use different usernames for different user profiles in User Management and VPN profiles.

## Authentication via Telnet

The LAN clients can also authenticate their accounts via telnet.

1. Telnet to the router's LAN IP address and input the account name for the authentication:



2. Enter the password for authentication and press Enter. The message User login successful will be displayed with the expired time (if configured).

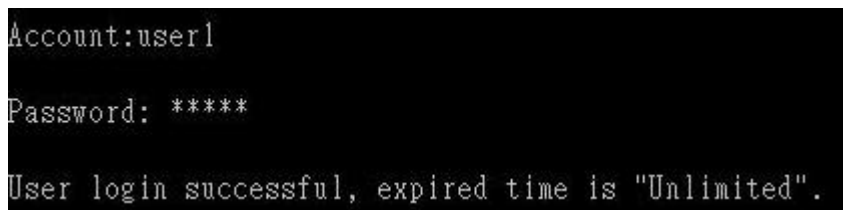

### Info

Here expired time is “Unlimited” means the Time Quota function is not enabled for this account. After login, this account will not be expired until it is logout.

3. In the Web interface of router, the configuration page of Time Quota is shown as below.

User Management >> User Profile

---

Profile Index 3  
Common Settings

|                                                         |                                        |
|---------------------------------------------------------|----------------------------------------|
| <input checked="" type="checkbox"/> Enable this account |                                        |
| Username                                                | user1 (Only support A-Z a-z 0-9 - . @) |
| Password                                                | *****                                  |
| Confirm Password                                        |                                        |
| External Server Authentication                          | None                                   |

Login Settings User Online Status : Block/ Unblock

|                               |                                         |                                                |                                            |
|-------------------------------|-----------------------------------------|------------------------------------------------|--------------------------------------------|
| Allow Authentication via      | <input checked="" type="checkbox"/> Web | <input checked="" type="checkbox"/> Alert Tool | <input checked="" type="checkbox"/> Telnet |
| Show Landing Page After Login | <input type="checkbox"/>                |                                                |                                            |
| Idle Timeout                  | 10 min. (0: Unlimited)                  |                                                |                                            |
| Auto Logout After             | 0 min. (0: Off)                         |                                                |                                            |
| Pop up Time-Tracking Window   | <input checked="" type="checkbox"/>     |                                                |                                            |
| Login Permission              | Schedule                                | None                                           | None                                       |

Policy

|                                                       |                                                                                                               |                 |   |   |
|-------------------------------------------------------|---------------------------------------------------------------------------------------------------------------|-----------------|---|---|
| Max. Login Devices                                    | 0 (0: Unlimited)                                                                                              |                 |   |   |
| <input checked="" type="checkbox"/> Enable Time Quota | 0 min.                                                                                                        | -               | 0 | + |
| <input type="checkbox"/> Enable Data Quota            | 0 MB                                                                                                          | -               | 0 | + |
| <input type="checkbox"/> Reset Quota Automatically To | Time Limit 0 min.                                                                                             | Data Limit 0 MB |   |   |
| When                                                  | <input checked="" type="radio"/> Login Permission Schedule Ends<br><input type="radio"/> Schedule None Starts |                 |   |   |



4. If the Time Quota is set with “0” minute, you will get the following message which means this account has no time quota.

```
Account:user1
Password: *****
User's time is up, or it has not enough time quota.
```

If the Time Quota is enabled and time is *not* 0 minute,

User Management >>User Profile

---

Profile Index 3  
Common Settings

|                                                         |       |                                  |  |
|---------------------------------------------------------|-------|----------------------------------|--|
| <input checked="" type="checkbox"/> Enable this account |       |                                  |  |
| Username                                                | user1 | (Only support A-Z a-z 0-9 - . @) |  |
| Password                                                | ***** |                                  |  |
| Confirm Password                                        |       |                                  |  |
| External Server Authentication                          | None  |                                  |  |

Login Settings User Online Status : Block/ Unblock

|                                      |                                         |                                                |                                            |
|--------------------------------------|-----------------------------------------|------------------------------------------------|--------------------------------------------|
| Allow Authentication via             | <input checked="" type="checkbox"/> Web | <input checked="" type="checkbox"/> Alert Tool | <input checked="" type="checkbox"/> Telnet |
| Show <u>Landing Page</u> After Login | <input type="checkbox"/>                |                                                |                                            |
| Idle Timeout                         | 10                                      | min.                                           | (0: Unlimited)                             |
| Auto Logout After                    | 0                                       | min.                                           | (0: Off)                                   |
| Pop up Time-Tracking Window          | <input checked="" type="checkbox"/>     |                                                |                                            |
| Login Permission <u>Schedule</u>     | None                                    | None                                           | None                                       |

Policy

|                                                       |                                                                                                                      |                |                 |
|-------------------------------------------------------|----------------------------------------------------------------------------------------------------------------------|----------------|-----------------|
| Max. Login Devices                                    | 0                                                                                                                    | (0: Unlimited) |                 |
| <input checked="" type="checkbox"/> Enable Time Quota | 0                                                                                                                    | min.           | - 120 +         |
| <input type="checkbox"/> Enable Data Quota            | 0                                                                                                                    | MB             | - 0 +           |
| <input type="checkbox"/> Reset Quota Automatically To | Time Limit 0                                                                                                         | min.           | Data Limit 0 MB |
| When                                                  | <input checked="" type="radio"/> Login Permission Schedule Ends<br><input type="radio"/> <u>Schedule</u> None Starts |                |                 |

You will get the following message. The expired time is shown after you login.

```
Account:user1
Password: *****
User login successful, expired time is "12-23 10:21:33".
```

After you run out the available time, you can't use this account any more until the administrator manually adds additional time for you.



## A-2 How to use Landing Page Feature

Landing Page is a special feature configured under User Management. It can specify the message, content to be seen or specify which website to be accessed into when users try to access into the Internet by passing the authentication. Here, we take Vigor2927 series router as an example.

Example 1 : Users can see the message for landing page after logging into Internet successfully

1. Open the web user interface of Vigor2927.
2. Open User Management -> General Setup to get the following page. In the field of Landing Page, please Enter the words of "Login Success". Please note that the maximum number of characters to be typed here is 255.
3. Now you can enable the Landing Page function. Open User Management -> User Profile and click one of the index number (e.g., index number 3) links.

User Management >> User Profile

---

User Profile Table

| Profile            | Name         |
|--------------------|--------------|
| <a href="#">1.</a> | admin        |
| <a href="#">2.</a> | Dial-In User |
| <a href="#">3.</a> |              |
| <a href="#">4.</a> |              |

4. In the following page, check the box of Landing page and click OK to save the settings.

User Management >> User Profile

---

Profile Index 3

Common Settings

|                                                         |                                                                     |
|---------------------------------------------------------|---------------------------------------------------------------------|
| <input checked="" type="checkbox"/> Enable this account |                                                                     |
| Username                                                | <input type="text" value="user1"/> (Only support A-Z a-z 0-9 - . @) |
| Password                                                | <input type="password" value="*****"/>                              |
| Confirm Password                                        | <input type="password"/>                                            |
| External Server Authentication                          | <input type="text" value="None"/>                                   |

Login Settings User Online Status : [Block](#) / [Unblock](#)

|                                               |                                                     |                                                |                                            |
|-----------------------------------------------|-----------------------------------------------------|------------------------------------------------|--------------------------------------------|
| Allow Authentication via                      | <input checked="" type="checkbox"/> Web             | <input checked="" type="checkbox"/> Alert Tool | <input checked="" type="checkbox"/> Telnet |
| Show <a href="#">Landing Page</a> After Login | <input checked="" type="checkbox"/>                 |                                                |                                            |
| Idle Timeout                                  | <input type="text" value="10"/> min. (0: Unlimited) |                                                |                                            |
| Auto Logout After                             | <input type="text" value="0"/> min. (0: Off)        |                                                |                                            |
| Pop up Time-Tracking Window                   | <input checked="" type="checkbox"/>                 |                                                |                                            |
| Login Permission <a href="#">Schedule</a>     | <input type="text" value="None"/>                   | <input type="text" value="None"/>              | <input type="text" value="None"/>          |

Policy

|                                                       |                                                                                                                                                            |
|-------------------------------------------------------|------------------------------------------------------------------------------------------------------------------------------------------------------------|
| Max. Login Devices                                    | <input type="text" value="0"/> (0: Unlimited)                                                                                                              |
| <input checked="" type="checkbox"/> Enable Time Quota | <input type="text" value="0"/> min. <input type="text" value="120"/> <input type="text" value="+"/>                                                        |
| <input type="checkbox"/> Enable Data Quota            | <input type="text" value="0"/> <input type="text" value="MB"/> <input type="text" value="0"/> <input type="text" value="+"/>                               |
| <input type="checkbox"/> Reset Quota Automatically To | Time Limit <input type="text" value="0"/> min. Data Limit <input type="text" value="0"/> MB                                                                |
| When                                                  | <input checked="" type="radio"/> Login Permission Schedule Ends<br><input type="radio"/> <a href="#">Schedule</a> <input type="text" value="None"/> Starts |

5. Open any browser (e.g., FireFox, Internet Explorer). The logging page will appear and asks for username and password. Please Enter the correct username and password.



A login form with a light gray background and a red footer. The form contains two input fields: "Username" with the text "CaCa" and "Password" with four black dots. A "Login" button is positioned to the right of the password field. The footer contains the text "Copyright©, DrayTek Corp. All Rights Reserved." and the "DrayTek" logo.

6. Click Login. If the logging is successful, you will see the message of Login Success from the browser you use.

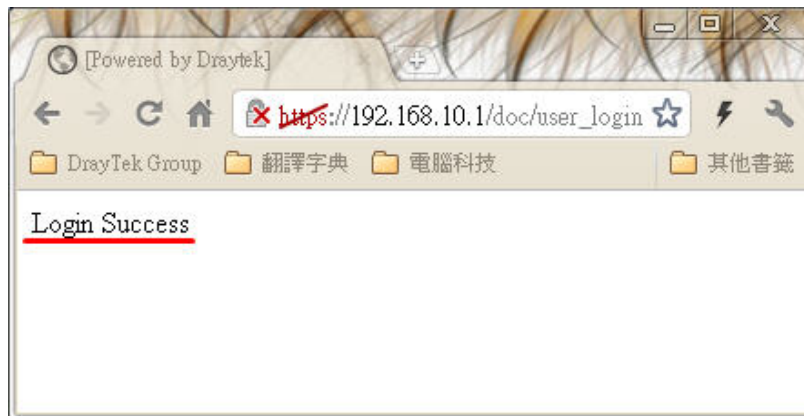

Example 2 : The system will connect to <http://www.draytek.com> automatically after logging into Internet successfully

- In the field of Landing Page, please Enter the words as below:  
 “ `<body stats=1><script language='javascript'>  
 window.location='http://www.draytek.com'</script></body>` ”

User Management >> General Setup

---

General Setup

**Mode Selection:**

Rule-Based is a management method based on IP address. Administrator may set different firewall rules to different IP address.

User-Based is a management method based on user profiles. Administrator may set different firewall rules to different user profiles.

**Notice for User-Based mode:**

- In User-Based mode, **Active Rules** in Firewall will be applied to all LAN clients, packets that matches the Active Rules will be blocked or pass immediately, no user authentication is required.
- Only **Inactive Rules** in Firewall can be set for individual user profile. In User-Based mode, packets that do not match Active Rules will need authentication, and the Inactive Rule applied to the specific user profile will then take effect.

**Authentication page:**

Web Authentication:  HTTPS  HTTP

[Login Page Greeting](#)

Display IP address on the dialog box pops up after successful login.

**Landing page:**

(Max 255 characters) [Preview](#) [Set to Factory Default](#)

```
<body stats=1><script language='javascript'>
window.location='http://www.draytek.com'</script></body>
```

- Next, enable the Landing Page function. Open User Management -> User Profile and click one of the index number (e.g., index number 3) links.

User Management >> User Profile

---

User Profile Table

| Profile            | Name         |
|--------------------|--------------|
| <a href="#">1.</a> | admin        |
| <a href="#">2.</a> | Dial-In User |
| <a href="#">3.</a> |              |
| <a href="#">4.</a> |              |

- In the following page, check the box of Landing page and click OK to save the settings.

User Management >>User Profile

Profile Index 3  
Common Settings

|                                       |                                        |                                  |
|---------------------------------------|----------------------------------------|----------------------------------|
| <input checked="" type="checkbox"/>   | Enable this account                    |                                  |
| Username                              | <input type="text" value="Caca"/>      | (Only support A-Z a-z 0-9 - . @) |
| Password                              | <input type="password" value="*****"/> |                                  |
| Confirm Password                      | <input type="password"/>               |                                  |
| <b>External Server Authentication</b> | <input type="text" value="None"/>      |                                  |

Login Settings **User Online Status** : Block/ Unblock

|                                      |                                         |                                                |                                            |
|--------------------------------------|-----------------------------------------|------------------------------------------------|--------------------------------------------|
| Allow Authentication via             | <input checked="" type="checkbox"/> Web | <input checked="" type="checkbox"/> Alert Tool | <input checked="" type="checkbox"/> Telnet |
| Show <b>Landing Page</b> After Login | <input checked="" type="checkbox"/>     |                                                |                                            |
| Idle Timeout                         | <input type="text" value="10"/>         | min. (0: Unlimited)                            |                                            |
| Auto Logout After                    | <input type="text" value="0"/>          | min. (0: Off)                                  |                                            |
| Pop up Time-Tracking Window          | <input checked="" type="checkbox"/>     |                                                |                                            |
| Login Permission <b>Schedule</b>     | <input type="text" value="None"/>       | <input type="text" value="None"/>              | <input type="text" value="None"/>          |

- Open any browser (e.g., FireFox, Internet Explorer). The logging page will appear and asks for username and password. Please Enter the correct username and password.

- Click Login. If the logging is successful, you will be directed into the website of www.draytek.com.

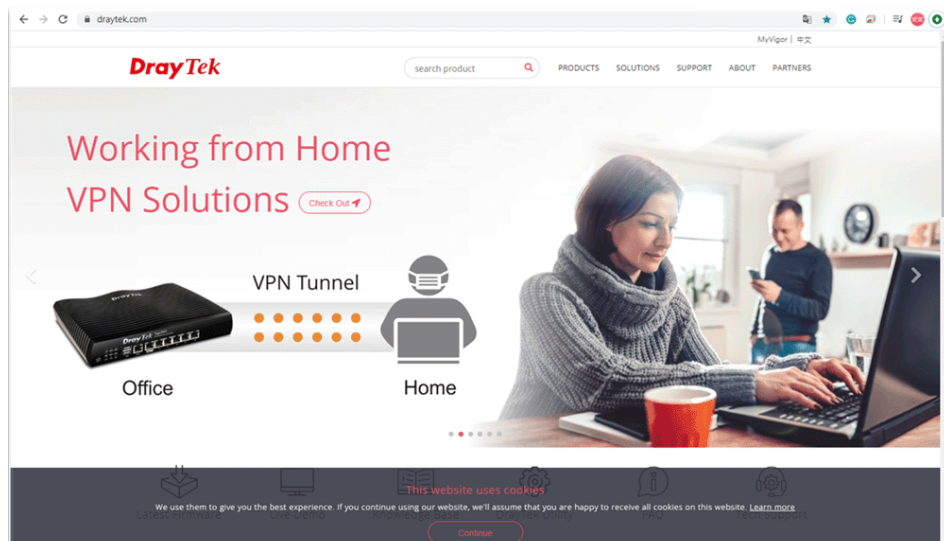

---

## VII-4 Hotspot Web Portal

The Hotspot Web Portal feature allows you to set up profiles so that LAN users could either be redirected to specific URLs, or be shown messages when they first connect to the Internet through the router. Users could be required to read and agree to terms and conditions, or authenticate themselves, prior to gaining access to the Internet. Other potential uses include the serving of advertisements and promotional materials, and broadcast of public service announcements.

---

## Web User Interface



---

### VII-4-1 Profile Setup

Select Profile Setup to create or modify Portal profiles. Up to 4 profiles can be created to meet different requirements according to LAN subnets, WLAN SSIDs, origin and destination IP addresses, etc.

Hotspot Web Portal >> Profile Setup ?

---

Hotspot Web Portal Profile:

| Index              | Enable                   | Comments | Login Mode    | Applied Interface |         |
|--------------------|--------------------------|----------|---------------|-------------------|---------|
| <a href="#">1.</a> | <input type="checkbox"/> |          | Click-through | None              | Preview |
| <a href="#">2.</a> | <input type="checkbox"/> |          | Click-through | None              | Preview |
| <a href="#">3.</a> | <input type="checkbox"/> |          | Click-through | None              | Preview |
| <a href="#">4.</a> | <input type="checkbox"/> |          | Click-through | None              | Preview |

Preview hotspot from WAN and VPN

**Note:**

1. The router must connect to the Internet before webpage redirection will work.
2. If the LAN clients are using another DNS server on LAN, please make sure the DNS query for domain name "portal.draytek.com" will be resolved by the router.
3. If you want to enable Preview hotspot from WAN and VPN, please set up [Internet Access Control](#).

|                                                                                              |                                                                                                                                            |
|----------------------------------------------------------------------------------------------|--------------------------------------------------------------------------------------------------------------------------------------------|
| Backup up <input type="button" value="Profile 1 v"/> : <input type="button" value="Backup"/> | Restore <input type="button" value="選擇檔案"/> 未選擇任何檔案 to <input type="button" value="Profile 1 v"/> : <input type="button" value="Restore"/> |
| <input type="checkbox"/> Restore Quota Management Setting                                    |                                                                                                                                            |

Available settings are explained as follows:

| Item     | Description                                                         |
|----------|---------------------------------------------------------------------|
| Index    | Click the index number link to view or update the profile settings. |
| Enable   | Check the box to enable the profile.                                |
| Comments | Shows the description of the profile.                               |

|                   |                                                                                                                                                                                                                                                                                                                                       |
|-------------------|---------------------------------------------------------------------------------------------------------------------------------------------------------------------------------------------------------------------------------------------------------------------------------------------------------------------------------------|
| Login Mode        | Shows the login mode used by the profile. See the section <i>Login Mode</i> for details.                                                                                                                                                                                                                                              |
| Applied Interface | Shows the interfaces to which this profile applies.                                                                                                                                                                                                                                                                                   |
| Preview           | Click this button to preview the Hotspot Web Portal page that will be displayed to users.                                                                                                                                                                                                                                             |
| Backup up         | Profile list - Select a source profile.<br>Backup - Click to save the configuration file based on the selected source profile.                                                                                                                                                                                                        |
| Restore ...       | Select - Click to choose a configuration file.<br>to.. - Select a destination profile. It will be restored by the selected configuration file.<br>Restore - Click to perform the restoration job.<br>Restore Quota Management Setting - If selected, the quota management setting also will be restored onto the destination profile. |

#### VII-4-1-1 Login Method

There are four login methods to choose from for authenticating network clients: Skip Login, Click Through, Various Hotspot Login, and External Portal Server Login. Each login mode will present a different web page to users when they connect to the network.

##### (A) Skip Login, landing page only

This mode does not perform any authentication. The user will be redirected to the landing page. The user can then leave the landing page to visit other websites.

##### (B) Click-through

The following page will be shown to the users when they first attempt to access the Internet through the router. After clicking Accept on the page, users will be directed to the landing page (defined in Captive Portal URL) and be granted access to the Internet.

##### (C) Various Hotspot Login

An authentication page will appear when users attempt to access the Internet for the first time via the router. After authenticating themselves using a Facebook account, Google account, PIN code, password for RADIUS server, they will be directed to the landing page and be granted access to the Internet.

##### (D) External Portal Server

External RADIUS server will authenticate the users when they attempt to access the Internet for the first time via the router.



## VII-4-1-2 Steps for Configuring a Web Portal Profile

### 1 Login Method

Click the index link (e.g., #1) of the selected profile to display the following page.

Hotspot Web Portal >> Profile Setup

---

1
2
3
4
5

Login Method
Background
Login Page Setup
Whitelist Setting
More Options

Enable this profile

Comments:

---

**Portal Server**

Portal Method

- Skip Login, landing page only
- Click through
- Various Hotspot Login
- External Portal Server

Captive Portal URL

Available settings are explained as follows:

| Item                                                                                      | Description                                                                                                                                                                                                                                                                                                                          |
|-------------------------------------------------------------------------------------------|--------------------------------------------------------------------------------------------------------------------------------------------------------------------------------------------------------------------------------------------------------------------------------------------------------------------------------------|
| Enable this profile                                                                       | Check to enable this profile.                                                                                                                                                                                                                                                                                                        |
| Comments                                                                                  | Enter a brief description to identify this profile.                                                                                                                                                                                                                                                                                  |
| <b>Portal Server</b>                                                                      |                                                                                                                                                                                                                                                                                                                                      |
| Portal Method                                                                             | There are four methods to be selected as for portal server. <ul style="list-style-type: none"> <li><input type="radio"/> Skip Login, landing page only</li> <li><input checked="" type="radio"/> Click through</li> <li><input type="radio"/> Various Hotspot Login</li> <li><input type="radio"/> External Portal Server</li> </ul> |
| <i>When Skip Logging, landing page only or Click through is selected as Portal Method</i> |                                                                                                                                                                                                                                                                                                                                      |
| Captive Portal URL                                                                        | Enter the captive portal URL.                                                                                                                                                                                                                                                                                                        |
| <i>When Various Hotspot Login is selected as Portal Method</i>                            |                                                                                                                                                                                                                                                                                                                                      |
| Captive Portal URL                                                                        | Enter the captive portal URL.                                                                                                                                                                                                                                                                                                        |
| Login Methods                                                                             | This setting is available when Various Hotspot Login is selected as the portal method.                                                                                                                                                                                                                                               |

|                                                                 |                                                                                                                                                                                                                                                                                                                                                                                                                                                                                                                                             |
|-----------------------------------------------------------------|---------------------------------------------------------------------------------------------------------------------------------------------------------------------------------------------------------------------------------------------------------------------------------------------------------------------------------------------------------------------------------------------------------------------------------------------------------------------------------------------------------------------------------------------|
|                                                                 | <p>Choose Login Method - Select one or more desired login methods.</p> <ul style="list-style-type: none"> <li>● Login with Facebook</li> <li>● Login with Google</li> <li>● Receive PIN via SMS</li> <li>● Receive PIN via Mail</li> <li>● PIN with Voucher</li> <li>● Login with RADIUS</li> <li>● Leave Info Login</li> </ul>                                                                                                                                                                                                             |
| Facebook<br>(Login with Facebook)                               | <p>This setting is available when Login with Facebook is selected as the login method.</p> <p>Facebook APP ID - Enter a valid Facebook developer app ID.<br/>If you do not already have an app ID, refer to section A-1 <i>How to create a Facebook App ID for Web Portal Authentication</i> for instructions on obtaining an APP ID.</p> <p>Facebook APP Secret - Enter the secret configured for the APP ID entered above.<br/>Refer to section A-1 <i>How to create a Facebook App ID for Web Portal Authentication</i> for details.</p> |
| Google<br>(Login with Google)                                   | <p>This setting is available when Login with Google is selected as the login method.</p> <p>Google App ID - Enter a valid Google app ID.<br/>If you do not already have an app ID, refer to section A-2 <i>How to create a Google App ID for Web Portal Authentication</i> for instructions on obtaining an APP ID.</p> <p>Google App Secret - Enter the secret configured for the APP ID entered above.<br/>Refer to section A-2 <i>How to create a Google APP ID for Web Portal Authentication</i> for details.</p>                       |
| SMS Provider<br>(Receive PIN via SMS)                           | <p>This setting is available when Receive PIN via SMS is selected as the login method.</p> <p>Receiving PIN via SMS Provider - Select the SMS Provider used to send PIN notifications. SMS providers are configured in Objects Setting &gt;&gt; SMS / Mail Service Object.</p>                                                                                                                                                                                                                                                              |
| Mail Server<br>(Receive PIN via Mail)                           | <p>This setting is available when Receive PIN via Mail is selected as the login method.</p> <p>Receiving PIN via Mail Server - Select the mail server used to send PIN notifications. Mail servers are configured in Objects Setting &gt;&gt; SMS / Mail Service Object.</p>                                                                                                                                                                                                                                                                |
| Radius Server<br>(Login with RADIUS)                            | <p>This setting is available when Login with RADIUS is selected as the login method.</p> <p>Authentication Method - Click link to configure the external RADIUS server for authenticating web portal clients.</p> <p>RADIUS MAC Authentication - Check Enable to activate user authentication by MAC address.</p> <p>MAC Address Format - Select the MAC address format that is used by the RADIUS server.</p> <p>RADIUS NAS-Identifier - Enter an ID.</p>                                                                                  |
| <i>When External Portal Server is selected as Portal Method</i> |                                                                                                                                                                                                                                                                                                                                                                                                                                                                                                                                             |
| Redirection URL                                                 | Enter the URL to which the client will be redirected.                                                                                                                                                                                                                                                                                                                                                                                                                                                                                       |
| RADIUS Server                                                   | Authentication Method - To configure the RADIUS server, click the <a href="#">External RADIUS Server</a> link and you will be presented with the                                                                                                                                                                                                                                                                                                                                                                                            |

|               |                                                                                                                                                                                                                                                                                                                                                              |
|---------------|--------------------------------------------------------------------------------------------------------------------------------------------------------------------------------------------------------------------------------------------------------------------------------------------------------------------------------------------------------------|
|               | <p>configuration page.</p> <p><b>RADIUS MAC Authentication</b> - If the RADIUS server supports authentication by MAC address, enable RADIUS MAC Authentication and select the MAC address format that is used by the RADIUS server.</p> <p><b>MAC Address Format</b> - Select the MAC address format.</p> <p><b>RADIUS NAS-Identifier</b> - Enter an ID.</p> |
| Save and Next | Click to save the configuration on this page and proceed to the next page.                                                                                                                                                                                                                                                                                   |
| Cancel        | Click to save the configuration on this page and proceed to the next page.                                                                                                                                                                                                                                                                                   |

If you have chosen Skip Login, landing page only or External Portal Server as the portal method, skip to step 4 *Whitelisting* below.

Otherwise, proceed to configure the login page by following steps 2 and 3.

## 2 Background

If you have selected a Login Mode that requires authentication, select a background for the login page.

Hotspot Web Portal >> Profile Setup

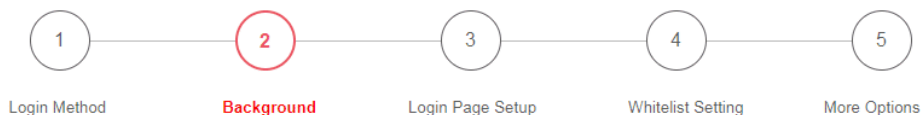

### Choose Login Background

Color Background

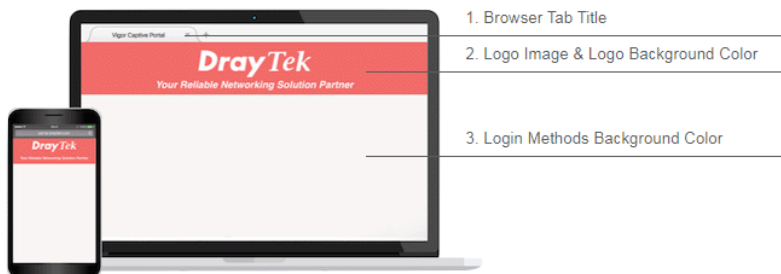
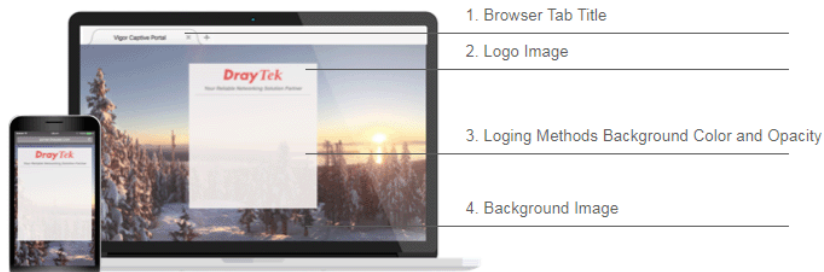

Image Background



Available settings are explained as follows:

| Item                          | Description                                                                                                                                                                    |
|-------------------------------|--------------------------------------------------------------------------------------------------------------------------------------------------------------------------------|
| Choose Login Background       | Select either Color Background or Image Background as the login page background scheme.                                                                                        |
| Browser Tab Title             | Enter the text to be shown as the webpage title in the browser.                                                                                                                |
| Logo Image                    | The DrayTek Logo will be displayed by default. However, you can enter HTML text or upload an image to replace the default logo.                                                |
| Logo Background Color         | Select the background color of DrayTek Logo, or select Customize Color and enter the RGB value. Click Preview to preview the selected color.                                   |
| Login Method Background Color | Select the background color of the login panel from the predefined color list, or select Customize Color and enter the RGB value. Click Preview to preview the selected color. |
| Opacity (10 ~ 100)            | Available when Image Background is selected. Set the opacity of the background image.                                                                                          |

|                  |                                                                                                                                                           |
|------------------|-----------------------------------------------------------------------------------------------------------------------------------------------------------|
| Background Image | Available when Image Background is selected. Click Browse... to select an image file (.JPG or .PNG format), then click Upload to upload it to the router. |
| Save and Next    | Click to save the configuration on this page and proceed to the next page.                                                                                |
| Cancel           | Click to abort the configuration process and return to the profile summary page.                                                                          |

If you have selected Skip Login, landing page only or External Portal Server as the portal method, proceed to Step 4 *Whitelist Setting*; otherwise, continue to Step 3 *Login Page Setup*.

## 3 Login Page Setup

In this step you can configure settings for the login page.

### Click Through

This section describes the Login Page setup if you have selected Click Through as the Login Method.

Hotspot Web Portal >> Profile Setup



#### Configure Login Method and Details

|                                                                                                                                                                                                                                                              |                                                                                                                                                                                                                                                                                          |
|--------------------------------------------------------------------------------------------------------------------------------------------------------------------------------------------------------------------------------------------------------------|------------------------------------------------------------------------------------------------------------------------------------------------------------------------------------------------------------------------------------------------------------------------------------------|
| <div style="border: 1px solid #ccc; padding: 10px; text-align: center;"> <p>Welcome!<br/>Please log in to enjoy Wi-Fi.</p> <p>By clicking the button below you agree to the<br/><a href="#">Terms and Conditions</a></p> <p> Log in with Facebook</p> </div> | <p><b>Welcome Message</b></p> <hr/> <p><b>Privacy Policy &amp; Terms and Conditions</b></p> <hr/> <p><b>Facebook Login</b></p> <hr/>                                                                                                                                                     |
| <p><b>Welcome Message</b></p>                                                                                                                                                                                                                                | <div style="border: 1px solid #ccc; padding: 5px; min-height: 40px;">             Welcome!&lt;br /&gt;Please log in to enjoy Wi-Fi.         </div> <p style="font-size: small;">(Max 1360 characters)</p> <p style="text-align: right; font-size: x-small;">Default</p>                  |
| <p><b>Privacy Policy &amp; Terms and Conditions</b></p>                                                                                                                                                                                                      | <p><b>Terms and Conditions</b></p> <p><input checked="" type="checkbox"/> Enable</p> <p><input checked="" type="checkbox"/> User must tick to get the internet access</p>                                                                                                                |
| <p><b>Description</b></p>                                                                                                                                                                                                                                    | <div style="border: 1px solid #ccc; padding: 5px; min-height: 40px;">             By clicking the button below you agree to the Terms and Conditions.         </div> <p style="font-size: small;">(Max 170 characters)</p> <p style="text-align: right; font-size: x-small;">Default</p> |

Available settings are explained as follows:

| Item | Description |
|------|-------------|
|------|-------------|

Login dialog will be shown as follows:

#### Configure Login Method and Details

|                                                                                                                                                                                                                                                                                                                                                           |                                                                                                                                                              |
|-----------------------------------------------------------------------------------------------------------------------------------------------------------------------------------------------------------------------------------------------------------------------------------------------------------------------------------------------------------|--------------------------------------------------------------------------------------------------------------------------------------------------------------|
| <div style="border: 1px solid #ccc; padding: 10px; text-align: center;"> <p>Welcome!</p> <p>We are pleased to provide free<br/>Wi-Fi to you!</p> <p>By clicking the button below you agree to the<br/><a href="#">Terms and Conditions</a></p> <p style="background-color: #f44336; color: white; padding: 5px; display: inline-block;">Accept</p> </div> | <p><b>Welcome Message</b></p> <hr/> <p><b>Terms and Conditions Description and Content</b></p> <hr/> <p><b>Accept Button Description and Color</b></p> <hr/> |
|-----------------------------------------------------------------------------------------------------------------------------------------------------------------------------------------------------------------------------------------------------------------------------------------------------------------------------------------------------------|--------------------------------------------------------------------------------------------------------------------------------------------------------------|

However, when PIN with Voucher is selected as the login method, Login dialog will be

shown as follows:

#### Configure Login Method and Details

|                                                                                                                                                                                                                                                                                                                                                                                                                                                                                                                                                                                                                      |                                                                                                                                                                                               |
|----------------------------------------------------------------------------------------------------------------------------------------------------------------------------------------------------------------------------------------------------------------------------------------------------------------------------------------------------------------------------------------------------------------------------------------------------------------------------------------------------------------------------------------------------------------------------------------------------------------------|-----------------------------------------------------------------------------------------------------------------------------------------------------------------------------------------------|
| <p style="text-align: center;">Welcome!<br/>Please log in to enjoy Wi-Fi.</p> <p style="text-align: center; font-size: small;">By clicking the button below you agree to the<br/><a href="#">Terms and Conditions</a></p> <p style="text-align: center; font-size: small;">Or log in with PIN code.</p> <div style="display: flex; justify-content: space-between; align-items: center;"> <input style="width: 60%; border: 1px solid #ccc;" type="text" value="Enter Existing PIN"/> <input style="background-color: #e91e63; color: white; padding: 5px 10px; border: none;" type="button" value="Submit"/> </div> | <p><b>Welcome Message</b></p> <hr/> <p><b>Terms and Conditions Description and Content</b></p> <hr/> <p><b>Hint Message for PIN</b></p> <hr/> <p><b>Enter PIN and Submit Button</b></p> <hr/> |
|----------------------------------------------------------------------------------------------------------------------------------------------------------------------------------------------------------------------------------------------------------------------------------------------------------------------------------------------------------------------------------------------------------------------------------------------------------------------------------------------------------------------------------------------------------------------------------------------------------------------|-----------------------------------------------------------------------------------------------------------------------------------------------------------------------------------------------|

|                                                               |                                                                                                                                                                                                                                                                                                                                                                                                                                                                                                                                                 |
|---------------------------------------------------------------|-------------------------------------------------------------------------------------------------------------------------------------------------------------------------------------------------------------------------------------------------------------------------------------------------------------------------------------------------------------------------------------------------------------------------------------------------------------------------------------------------------------------------------------------------|
| Welcome Message                                               | Enter the text to be displayed as the welcome message.                                                                                                                                                                                                                                                                                                                                                                                                                                                                                          |
| <b>Privacy Policy &amp; Terms and Conditions</b>              |                                                                                                                                                                                                                                                                                                                                                                                                                                                                                                                                                 |
| Terms and Conditions                                          | <p>Enable - Check the box to enable the option.</p> <p>User must tick to get the internet access - This check box is enabled in default if Terms and Conditions is enabled.</p> <p>Description - Enter the text to be displayed in the Terms and Conditions pop-up window.</p> <p>Content - It contains Internal Content and External Content. Choose Internal Content to enter the text to be displayed as the Terms and Conditions hyperlink text. Or choose External Content to enter an URL that will display the terms and conditions.</p> |
| Data Collection for Marketing                                 | <p>Enable - Check the box to enable the option.</p> <p>User must tick to get the internet access - Check the box to enable the option.</p> <p>Description - Enter the text to inform the user.</p>                                                                                                                                                                                                                                                                                                                                              |
| Error message when the user does not tick                     | Enter the text to notify the user.                                                                                                                                                                                                                                                                                                                                                                                                                                                                                                              |
| Accept Button Description                                     | Enter the text to be displayed on the accept button.                                                                                                                                                                                                                                                                                                                                                                                                                                                                                            |
| Accept Button Color                                           | Select the color of the accept button from the predefined color list, or select Customize Color and enter the RGB value. Click Preview to preview the selected color.                                                                                                                                                                                                                                                                                                                                                                           |
| Save and Next                                                 | Click to save the configuration on this page and proceed to the next page.                                                                                                                                                                                                                                                                                                                                                                                                                                                                      |
| Cancel                                                        | Click to abort the configuration process and return to the profile summary page.                                                                                                                                                                                                                                                                                                                                                                                                                                                                |
| <b>When PIN with Voucher is selected as the login method,</b> |                                                                                                                                                                                                                                                                                                                                                                                                                                                                                                                                                 |
| Hint Message for PIN                                          | Enter a message to remind the PIN code.                                                                                                                                                                                                                                                                                                                                                                                                                                                                                                         |
| Enter PIN Description                                         | Enter the existing PIN code.                                                                                                                                                                                                                                                                                                                                                                                                                                                                                                                    |
| Submit Button Description                                     | Enter the text to be displayed on the Submit button.                                                                                                                                                                                                                                                                                                                                                                                                                                                                                            |
| Submit Button Color                                           | Select the color of the Submit button from the predefined color list, or select Customize Color and enter the RGB value. Click Preview to preview the selected color.                                                                                                                                                                                                                                                                                                                                                                           |
| Save and Next                                                 | Click to save the configuration on this page and proceed to the next page.                                                                                                                                                                                                                                                                                                                                                                                                                                                                      |

|        |                                                                                  |
|--------|----------------------------------------------------------------------------------|
| Cancel | Click to abort the configuration process and return to the profile summary page. |
|--------|----------------------------------------------------------------------------------|

## Various Hotspot Login

This section describes the Login Page setup step if you have selected Various Hotspot Login the login method. You will see only settings that are relevant to the selected login method(s).

Hotspot Web Portal >> Profile Setup



### Configure Login Method and Details

|                                                                                                                                                                                                                                                                                                                                                                                                                                                                                                                                                                                                                                                                                                                                          |                                                                                                                                                                                                                                                                                                                                                                |
|------------------------------------------------------------------------------------------------------------------------------------------------------------------------------------------------------------------------------------------------------------------------------------------------------------------------------------------------------------------------------------------------------------------------------------------------------------------------------------------------------------------------------------------------------------------------------------------------------------------------------------------------------------------------------------------------------------------------------------------|----------------------------------------------------------------------------------------------------------------------------------------------------------------------------------------------------------------------------------------------------------------------------------------------------------------------------------------------------------------|
| <p>Welcome!<br/>Please log in to enjoy Wi-Fi.<br/>By clicking the button below you agree to the <a href="#">Terms and Conditions</a></p> <p> Log in with Facebook</p> <p> Log in with Google</p> <p>Or log in with PIN code.</p> <p>Receive PIN via SMS</p> <p>Enter Existing PIN <input type="text"/> <input type="button" value="Submit"/></p> <p>Or log in with your account.</p> <p>Username <input type="text"/></p> <p>Password <input type="password"/></p> <p><input type="button" value="Login"/></p> <p>Welcome!<br/>Please leave info to enjoy Wi-Fi.</p> <p>Your Name <input type="text"/></p> <p>Your Email <input type="text"/></p> <p>Mobile Number <input type="text"/></p> <p><input type="button" value="Submit"/></p> | <p>Welcome Message</p> <p>Privacy Policy &amp; Terms and Conditions</p> <p>Facebook Login</p> <p>Google Login</p> <p>Hint Message for PIN</p> <p>Receive PIN Description</p> <p>Enter PIN and Submit Button</p> <p>Hint Message for RADIUS</p> <p>RADIUS Login</p> <p>Hint Message for Leave info</p> <p>Leave info Columns and Descriptions</p> <p>Button</p> |
|------------------------------------------------------------------------------------------------------------------------------------------------------------------------------------------------------------------------------------------------------------------------------------------------------------------------------------------------------------------------------------------------------------------------------------------------------------------------------------------------------------------------------------------------------------------------------------------------------------------------------------------------------------------------------------------------------------------------------------------|----------------------------------------------------------------------------------------------------------------------------------------------------------------------------------------------------------------------------------------------------------------------------------------------------------------------------------------------------------------|

Welcome Message

(Max 1360 characters)

Privacy Policy & Terms and Conditions

Terms and Conditions  Enable

User must tick to get the internet access

Description

Settings that are common to Facebook, Google, PIN, and RADIUS authentication are:

| Item                 | Description                                                                                                   |
|----------------------|---------------------------------------------------------------------------------------------------------------|
| Welcome Message      | Enter the text to be displayed as the welcome message.                                                        |
| Terms and Conditions | Enable - Check the box to enable the option.<br>User must tick to get the internet access - This check box is |



|                                           |                                                                                                                                                                                                                                                                                                                                                                                                                               |
|-------------------------------------------|-------------------------------------------------------------------------------------------------------------------------------------------------------------------------------------------------------------------------------------------------------------------------------------------------------------------------------------------------------------------------------------------------------------------------------|
| Description                               | <p>enabled in default if Terms and Conditions is enabled.</p> <p>Description - Enter the text to be displayed in the Terms and Conditions pop-up window.</p> <p>Content - It contains Internal Content and External Content. Choose Internal Content to enter the text to be displayed as the Terms and Conditions hyperlink text. Or choose External Content to enter an URL that will display the terms and conditions.</p> |
| Data Collection for Marketing             | <p>Enable - Check the box to enable the option.</p> <p>User must tick to get the internet access - Check the box to enable the option.</p> <p>Description - Enter the text to inform the user.</p>                                                                                                                                                                                                                            |
| Error message when the user does not tick | Enter the text to notify the user.                                                                                                                                                                                                                                                                                                                                                                                            |

If you have selected Facebook login, the setting will appear:

|                            |                                                                                                      |
|----------------------------|------------------------------------------------------------------------------------------------------|
| Facebook Login Description | <input type="text" value="Log in with Facebook"/>                                                    |
|                            | <p>(Max 170 characters)</p> <p style="text-align: right;"><input type="button" value="Default"/></p> |

| Item                       | Description                                                  |
|----------------------------|--------------------------------------------------------------|
| Facebook Login Description | Enter the text to be displayed on the Facebook login button. |

If you have selected Google login, the setting will appear:

|                          |                                                                                                      |
|--------------------------|------------------------------------------------------------------------------------------------------|
| Google Login Description | <input type="text" value="Log in with Google"/>                                                      |
|                          | <p>(Max 170 characters)</p> <p style="text-align: right;"><input type="button" value="Default"/></p> |

| Item                     | Description                                                |
|--------------------------|------------------------------------------------------------|
| Google Login Description | Enter the text to be displayed on the Google login button. |

If you have selected PIN login, these settings will appear:

|                                |                                                                                                                |                      |         |
|--------------------------------|----------------------------------------------------------------------------------------------------------------|----------------------|---------|
| Hint Message for PIN           | Or log in with PIN code.                                                                                       | (Max 170 characters) | Default |
| Receiving PIN Description      | Receive PIN via SMS/Mail                                                                                       | (Max 170 characters) | Default |
| Receiving PIN via SMS Content  | Welcome to DrayTek Hotspot! Your PIN is <PIN>. This PIN is valid for 10 min.                                   | (Max 150 characters) | Default |
| Receiving PIN via Mail Subject |                                                                                                                | (Max 120 characters) | Default |
| Receiving PIN via Mail Content | clients3.google.com                                                                                            | (Max 170 characters) | Default |
| Enter PIN Description          | Enter Existing PIN                                                                                             | (Max 170 characters) | Default |
| Submit Button Description      | <span style="color:white;">Submit</span>                                                                       | (Max 170 characters) | Default |
| Submit Button Color            | Customize Color <input type="text" value="A2A2A2"/> (format : FFFFFFFF) <input type="button" value="Preview"/> |                      | Default |

| Item                           | Description                                                                                                                   |
|--------------------------------|-------------------------------------------------------------------------------------------------------------------------------|
| Hint Message for PIN           | Enter the text used to suggest users to choose SMS authentication.                                                            |
| Receiving PIN Description      | Enter the text to be displayed on the button that the user clicks to receive an SMS PIN.                                      |
| Receiving PIN via SMS Content  | Enter the message to be sent by SMS to inform the user of the PIN. The PIN variable is specified by <PIN> within the message. |
| Receiving PIN via Mail Subject | Enter the subject of the mail to inform the user about the PIN code.                                                          |
| Receiving PIN via Mail Content | Enter the content of the mail to inform the user about the PIN code.                                                          |
| Enter PIN Description          | Enter message to be displayed in the PIN textbox to prompt the user to enter the PIN.                                         |
| Submit Button                  | Enter the text to be displayed on the submit PIN button                                                                       |

|                     |                                                                                                                                                                       |
|---------------------|-----------------------------------------------------------------------------------------------------------------------------------------------------------------------|
| Description         |                                                                                                                                                                       |
| Submit Button Color | Select the color of the submit button from the predefined color list, or select Customize Color and enter the RGB value. Click Preview to preview the selected color. |

If you have selected RADIUS account login, these settings will appear:

|                             |                                                                                                                                               |                      |                                        |
|-----------------------------|-----------------------------------------------------------------------------------------------------------------------------------------------|----------------------|----------------------------------------|
| Hint Message for RADIUS     | <input type="text" value="Or log in with your account."/>                                                                                     | (Max 170 characters) | <input type="button" value="Default"/> |
| RADIUS Account Description  | <input type="text" value="Username"/>                                                                                                         | (Max 170 characters) | <input type="button" value="Default"/> |
| RADIUS Password Description | <input type="text" value="Password"/>                                                                                                         | (Max 170 characters) | <input type="button" value="Default"/> |
| Login Button Description    | <input type="text" value='&lt;span style="color:white"&gt;Login&lt;/span&gt;'/>                                                               | (Max 170 characters) | <input type="button" value="Default"/> |
| Login Button Color          | <input type="button" value="Customize Color"/> <input type="text" value="A2A2A2"/> (format : FFFFFFFF) <input type="button" value="Preview"/> |                      | <input type="button" value="Default"/> |

| Item                        | Description                                                                                                                                                          |
|-----------------------------|----------------------------------------------------------------------------------------------------------------------------------------------------------------------|
| Hint Message for RADIUS     | Enter the text used to prompt the user to login.                                                                                                                     |
| RADIUS Account Description  | Enter the text to prompt the user to enter the username.                                                                                                             |
| RADIUS Password Description | Enter the text to prompt the user to enter the password.                                                                                                             |
| Login Button Description    | Enter the text to be displayed on the login button.                                                                                                                  |
| Login Button Color          | Select the color of the login button from the predefined color list, or select Customize Color and enter the RGB value. Click Preview to preview the selected color. |

If you have selected Leave info login, these settings will appear:

---

Hint Message for Leave info

(Max 170 characters) Default

---

Leave info Columns and Descriptions

| Index | Enable                   | Column Type  | Required                 | Column Description(Max 170 characters) |
|-------|--------------------------|--------------|--------------------------|----------------------------------------|
| 1     | <input type="checkbox"/> | General Info | <input type="checkbox"/> | <input type="text"/>                   |
| 2     | <input type="checkbox"/> | Phone        | <input type="checkbox"/> | <input type="text"/>                   |
| 3     | <input type="checkbox"/> | General Info | <input type="checkbox"/> | <input type="text"/>                   |
| 4     | <input type="checkbox"/> | General Info | <input type="checkbox"/> | <input type="text"/>                   |
| 5     | <input type="checkbox"/> | General Info | <input type="checkbox"/> | <input type="text"/>                   |
| 6     | <input type="checkbox"/> | General Info | <input type="checkbox"/> | <input type="text"/>                   |
| 7     | <input type="checkbox"/> | General Info | <input type="checkbox"/> | <input type="text"/>                   |
| 8     | <input type="checkbox"/> | General Info | <input type="checkbox"/> | <input type="text"/>                   |
| 9     | <input type="checkbox"/> | General Info | <input type="checkbox"/> | <input type="text"/>                   |
| 10    | <input type="checkbox"/> | General Info | <input type="checkbox"/> | <input type="text"/>                   |

**Note:** Leave Info in this profile will be cleared if the settings in enabled column is modified.

Submit Button Descriptions

(Max 170 characters) Default

Submit Button Color Customize Color

A2A2A2 (format : FFFFFFFF) Preview Default

| Item                                | Description                                                                                                                                                                                                                                                                                                                                                                                                                                                         |
|-------------------------------------|---------------------------------------------------------------------------------------------------------------------------------------------------------------------------------------------------------------------------------------------------------------------------------------------------------------------------------------------------------------------------------------------------------------------------------------------------------------------|
| Hint Message for Leave info         | Enter a message to ask the user to leave personal information.                                                                                                                                                                                                                                                                                                                                                                                                      |
| Leave info Columns and Descriptions | <p>Index - There are ten entries can be modified.</p> <p>Enable - Check the box to enable the entry setting.</p> <p>Column Type - It contains General Info, Email, Phone and Checkbox.</p> <p>Required - Select to make this item be the required item. The client can not pass the server authentication if not offer the required information.</p> <p>Column Description - Information will be shown in watermark to prompt the user filling the information.</p> |
| Submit Button Description           | Enter the text to be displayed on the submit PIN button                                                                                                                                                                                                                                                                                                                                                                                                             |

|                     |                                                                                                                                                                       |
|---------------------|-----------------------------------------------------------------------------------------------------------------------------------------------------------------------|
| Submit Button Color | Select the color of the submit button from the predefined color list, or select Customize Color and enter the RGB value. Click Preview to preview the selected color. |
|---------------------|-----------------------------------------------------------------------------------------------------------------------------------------------------------------------|

And finally, the save and cancel buttons are always displayed.

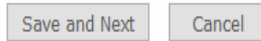

| Item          | Description                                                                      |
|---------------|----------------------------------------------------------------------------------|
| Save and Next | Click to save the configuration on this page and proceed to the next page.       |
| Cancel        | Click to abort the configuration process and return to the profile summary page. |

## 2nd-stage Page for PIN Login

If you have selected PIN Login as the login method, you will also need to configure the page that is displayed to users when they request a PIN.

Hotspot Web Portal >> Profile Setup

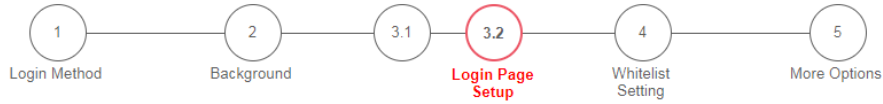

Configure 2nd-stage Page for SMS Login

|  |                                                                                                                                                                                                              |
|--|--------------------------------------------------------------------------------------------------------------------------------------------------------------------------------------------------------------|
|  | <p>Back Button</p> <p>PIN Code Message</p> <p>Default Country, Enter Mobile Number Description</p> <p>Send Button Description and Color</p> <p>Send Succeeded Message</p> <p>Enter PIN and Submit Button</p> |
|--|--------------------------------------------------------------------------------------------------------------------------------------------------------------------------------------------------------------|

Back Button Description

Back

(Max 170 characters) Default

PIN Code Message

PIN code will be sent over via Mail.

(Max 170 characters) Default

Enter Mail Address Description

enter your mail address

(Max 170 characters) Default

Send Button Description

<span style="color:white;">Send PIN</span>

(Max 170 characters) Default

Send Button Color

Customize Color

A2A2A2 (format : FFFFFFFF) Preview Default

Send Succeeded Message

PIN Code has been sent.Click <b>Send PIN</b> again if not receiving PIN in 3 minutes.

(Max 170 characters) Default

Save and Next
Cancel

Available settings are explained as follows:

| Item                    | Description                                                               |
|-------------------------|---------------------------------------------------------------------------|
| Back Button Description | Enter text for the label of the hyperlink to return to the previous page. |
| PIN Code Message        | Enter text to be displayed as the body text on the page.                  |

|                                 |                                                                                                                                                                     |
|---------------------------------|---------------------------------------------------------------------------------------------------------------------------------------------------------------------|
| Default Country Code            | Select the default country code to be displayed using the dropdown menu.                                                                                            |
| Enter Mobile Number Description | Enter message to be displayed in the mobile number textbox to prompt the user to enter the mobile number.                                                           |
| Send Button Description         | Enter the label text of the send button.                                                                                                                            |
| Send Button Color               | Select the color of the send button from the predefined color list, or select Customize Color and enter the RGB value. Click Preview to preview the selected color. |
| Send Succeeded Message          | Enter text to be displayed to notify the user after the PIN has been sent.                                                                                          |
| Save and Next                   | Click to save the configuration on this page and proceed to the next page.                                                                                          |
| Cancel                          | Click to abort the configuration process and return to the profile summary page.                                                                                    |

## 4 Whitelist Setting

In this step you can configure the whitelist settings. Users are allowed to send and receive traffic that satisfies whitelist settings.

Hotspot Web Portal >> Profile Setup

---

1  
Login Method

2  
Background

3  
Login Page Setup

4  
**Whitelist Setting**

5  
More Options

| NAT Rules                                       | Dest Domain | Dest IP                                                                                                                               | Dest Port | Source IP |
|-------------------------------------------------|-------------|---------------------------------------------------------------------------------------------------------------------------------------|-----------|-----------|
| Always allow outbound connections from hosts in |             | <input type="checkbox"/> NAT >> Port Redirection<br><input type="checkbox"/> NAT >> Open Ports<br><input type="checkbox"/> NAT >> DMZ |           |           |

Available settings are explained as follows:

| Item          | Description                                                                                                                                                                                                                                                                     |
|---------------|---------------------------------------------------------------------------------------------------------------------------------------------------------------------------------------------------------------------------------------------------------------------------------|
| NAT Rules     | To prevent web portal settings from conflicting with NAT rules resulting in unexpected behavior, select the NAT rules that are allowed to bypass the web portal. Hosts listed in selected NAT rules can always access the Internet without being intercepted by the web portal. |
| Dest Domain   | Enter up to 30 destination domains that are allowed to be accessed.                                                                                                                                                                                                             |
| Dest IP       | Enter up to 30 destination IP addresses that are allowed to be accessed.                                                                                                                                                                                                        |
| Dest Port     | Enter up to 30 destination protocols and ports that are allowed through the router.                                                                                                                                                                                             |
| Source IP     | Enter up to 30 source IP addresses that are allowed through the router.                                                                                                                                                                                                         |
| Save and Next | Click to save the configuration on this page and proceed to the next page.                                                                                                                                                                                                      |
| Cancel        | Click to abort the configuration process and return to the profile summary page.                                                                                                                                                                                                |



## 5 More Options

In this step you can configure advanced options for the Hotspot Web Portal.

Hotspot Web Portal >> Profile Setup

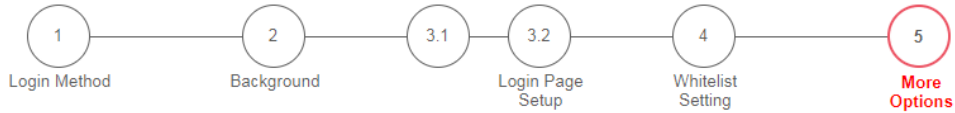

### Quota Management

| Login Method | Quota Policy Profile | Valid Time | Device Allowed | Bandwidth Limit | Session Limit |
|--------------|----------------------|------------|----------------|-----------------|---------------|
| Email Login  | 1.Default ▼          | 0d 5h 0m   | Unlimited      | Unlimited       | Unlimited     |
| Bypass       | 1.Default ▼          | 0d 5h 0m   | Unlimited      | Unlimited       | Unlimited     |

#### Note:

To modify the quota settings, please go to [Hotspot Web Portal >> Quota Management](#).

### JSON API

- Enable JSON API
- Server URL
- Get JSON and Update user status every  hours  min
- Update information
- NAS-Identifier  MAC Address  All User Number  Wi-Fi User Number

### Web Portal Options

- HTTPS Redirection**  Enable  
When an unauthenticated client opening a HTTPS page, redirect will work but certificate errors may be shown.  
Disable this function to redirect only HTTP pages. HTTPS browsing will timeout without redirection and also no certificate errors.
- Captive Portal Detection**  Enable  
Trigger the unauthenticated client to automatically pop-up the Web Portal page when connects to Wi-Fi.  
This function is not available when using **Social Login** because the page may not be shown correctly due to the limitation of the OS built-in Captive Portal Detection.
- Bypass**  Enable  
If the number of https sessions exceed the default limit, web portal would temporarily bypass them without authenticate.  
Those users would be redirected to web portal and authenticate later.

### Landing Page After Authentication

- Fixed URL
- User Requested URL
- Bulletin Message
- 

Available settings are explained as follows:

| Item                 | Description                                             |
|----------------------|---------------------------------------------------------|
| Quota Management     |                                                         |
| Quota Policy Profile | Choose a policy profile to apply to web portal clients. |

## JSON API

### Enable JSON API

Select to enable the JSON API format. A user can modify the hotspot settings and get the user information without accessing the WUI of the Vigor device.

**Server URL** - Enter the IP address or the domain name of the remote server. The server will be used for editing the hotspot settings using the JSON API format.

**Get JSON and Update user status every x hours x min** - Set the interval (hour and minute) for the router to get the JSON and user information.

**Update information** - Select the items that will be updated by the remote server.



#### Quota Management

| Login Method     | Quota Policy Profile | Valid Time | Device Allowed | Bandwidth Limit             | Session Limit |
|------------------|----------------------|------------|----------------|-----------------------------|---------------|
| Leave Info Login | 1.First_batch        | 0d 5h 0m   | Unlimited      | Up:500Kbps<br>Down:1000Kbps | 10000         |
| Bypass           | 1.First_batch        | 0d 5h 0m   | Unlimited      | Up:500Kbps<br>Down:1000Kbps | 10000         |

#### Note:

To modify the quota settings, please go to [Hotspot Web Portal >> Quota Management](#)

#### JSON API

Enable JSON API

Server URL

Get JSON and Update user status every  hours  min

Update information

NAS-Identifier  MAC Address  All User Number  Wi-Fi User Number

#### Web Portal Options

**HTTPS Redirection**

Enable

When an unauthenticated client opening a HTTPS page, redirect will work but

### Web Portal Options

#### HTTPS Redirection

If this option is selected, unauthenticated clients accessing HTTPS websites will be redirected to the login page, but the browser may alert the user of certificate errors. If this option is not selected, attempts to access to HTTPS website will time out without redirection.

#### Captive Portal Detection

If this option is selected, the web portal page is triggered automatically when an unauthenticated client tries to access the Internet. This function is not available when the Login Mode is Social Login, as the web portal page may not be shown correctly due to the limitations of the operating system's built-in Captive Portal Detection.

#### Bypass

If the number of HTTPS sessions exceeds the default limit, the web portal would temporarily bypass them without authenticate. Those clients would be redirected to the web portal and authenticate later.

### Landing Page After Authentication

#### Fixed URL

Specifies the webpage that will be displayed after the user has successfully authenticated. The user will be redirected to the specified URL. This could be used for displaying advertisements to users, such as guests requesting wireless Internet access in a hotel.

#### User Requested URL

The user will be redirected to the URL they initially requested.

|                           |                                                                                                                                                                                                                                   |
|---------------------------|-----------------------------------------------------------------------------------------------------------------------------------------------------------------------------------------------------------------------------------|
| Bulletin Message          | The message configured here will be briefly shown for a few seconds to the user.<br>Default Message - This button is enabled when Bulletin Message is selected. Click to load the default text into the bulletin message textbox. |
| <b>Applied Interfaces</b> |                                                                                                                                                                                                                                   |
| Subnet                    | The current Hotspot Web Portal profile will be in effect for the selected subnets.                                                                                                                                                |
| WLAN                      | The current Hotspot Web Portal profile will be in effect for the selected WLAN SSIDs.                                                                                                                                             |
| Finish                    | Click to complete the configuration.                                                                                                                                                                                              |
| Cancel                    | Click to abort the configuration process and return to the profile summary page.                                                                                                                                                  |

## VII-4-2 User Information

This page displays information of users accessing the Internet through the web portal. Clicking on a user link will open a new window that shows detailed information about that user.

### VII-4-2-1 User Info

You may choose to limit the displayed user information by adding profile or login method filters.

Hotspot Web Portal >> Users Information

| User Info                                               |                                     | Database Setup                     |  |
|---------------------------------------------------------|-------------------------------------|------------------------------------|--|
| <input type="checkbox"/> Select Columns to Filter Users |                                     |                                    |  |
| Profile                                                 | Login Method                        | Data Collection                    |  |
| <input type="checkbox"/> Profile1                       | <input type="checkbox"/> Skip       | <input type="checkbox"/> Marketing |  |
| <input type="checkbox"/> Profile2                       | <input type="checkbox"/> Click      |                                    |  |
| <input type="checkbox"/> Profile3                       | <input type="checkbox"/> Pincode    |                                    |  |
| <input type="checkbox"/> Profile4                       | <input type="checkbox"/> Facebook   |                                    |  |
|                                                         | <input type="checkbox"/> Google     |                                    |  |
|                                                         | <input type="checkbox"/> RADIUS     |                                    |  |
|                                                         | <input type="checkbox"/> Leave Info |                                    |  |
| <input type="button" value="OK"/>                       |                                     |                                    |  |

#### User Table

0 Online Users / 0 All Users

Auto Refresh (per min)

| [Refresh Now](#) |

| Index | Status | Profile | User | Login Methods | IP | MAC | Email | Phone Number | Expired Time |  |
|-------|--------|---------|------|---------------|----|-----|-------|--------------|--------------|--|
|-------|--------|---------|------|---------------|----|-----|-------|--------------|--------------|--|

**Note:**

Please set up [Database](#) to start showing user information.

Available settings are explained as follows:

| Item                           | Description                                                                                                                                                                                                       |
|--------------------------------|-------------------------------------------------------------------------------------------------------------------------------------------------------------------------------------------------------------------|
| Select Columns to Filter Users | Select the profiles and the login methods to filter the displayed users. This is useful when there are a lot of users and you want to manage only a subset of users based on their profiles and/or login methods. |
| User Table                     | Details of users accessing the Internet via Hotspot Web Portal will be displayed in this section.                                                                                                                 |

Click the MAC address (or pincode, facebook/google name, RADIUS account) link for a particular user and detailed information on the selected device will be shown in the following page.

**6c:8d:c1:45:25:9a****Login Info**

| User Name         | Login Methods | ID                | Email | Phone |
|-------------------|---------------|-------------------|-------|-------|
| 6c:8d:c1:45:25:9a | click-through | 6c:8d:c1:45:25:9a | -     | -     |

**Devices**

Log Out Device

| Index                      | Status  | IP           | MAC               | Online Time |
|----------------------------|---------|--------------|-------------------|-------------|
| <input type="checkbox"/> 1 | Offline | 192.168.1.11 | 6c:8d:c1:45:25:9a |             |

**Login History (Latest 10 entries)**

| Index | Login               | Logout              | Duration       | IP           | MAC               |
|-------|---------------------|---------------------|----------------|--------------|-------------------|
| 1     | 2017-09-29 10:30:02 | 2017-09-29 10:30:53 | 00d<br>00h:00m | 192.168.1.11 | 6c:8d:c1:45:25:9a |

OK

Information about the user is shown under the Login Info section.

Devices used by the user are shown under the Devices section. To forcibly log out a device, select the checkbox in front of the device and click the Log Out Device button.

The Login History section shows the 10 most recent login sessions of the user.

**VII-4-2-2 Database Setup**

This page allows the user to configure settings for database on USB disk.

| User Info | Database Setup |
|-----------|----------------|
|-----------|----------------|

- Enable database
- Enable automatic database recovery  
Backup database every  hours  min
- Enable sending user information to syslog

File Path : No USB Disk Detected

Database Usage : N/A

Clear User Info

**Notification and Action when Storage Exceeded**

- Notification
- Don't send notification
- Send notification
- Email Notification Object**
- SMS Notification Object**
- Action
- Stop recording user information
- Backup and clean up all user info, and start a new record

**Advanced options**

- Database Encryption
- Database encrypting is a irreversible process. Once enable Database Encryption, router will create a new encrypted database, which will not content the data from the non-encrypted database, and not able to change back to non-encrypted.
  - Encryption mechanism may affect router performance when writing data.

OK

Available settings are explained as follows:

| Item                                                 | Description                                                                                                                                                                                                                                                                                                                                       |
|------------------------------------------------------|---------------------------------------------------------------------------------------------------------------------------------------------------------------------------------------------------------------------------------------------------------------------------------------------------------------------------------------------------|
| Enable database                                      | Check the box to record user information on router's database.<br>Before checking this box, insert a USB disk with adequate storage space, first.                                                                                                                                                                                                 |
| Enable automatic database recovery                   | Check the box to enable the functionality of the database recovery on the USB disk.<br>Backup database every... - Set the interval to backup the database.                                                                                                                                                                                        |
| Enable sending user information to syslog            | Check the box to send user information to syslog.                                                                                                                                                                                                                                                                                                 |
| File Path                                            | If a USB disk has been inserted into the USB port of Vigor router, the file path will be shown in this area.                                                                                                                                                                                                                                      |
| Database Usage                                       | Display the usage and remaining space on the database.<br>Clear User Info - The user information will be displayed on the page of User Info. You can delete the information by clicking this button.                                                                                                                                              |
| <b>Notification and Action when Storage Exceeded</b> |                                                                                                                                                                                                                                                                                                                                                   |
| Notification                                         | Don't send notification - Vigor router system will not send any notification to any recipient.<br>Send notification - Vigor router system will send a notification e-mail to specified recipient(s) that selected from Email Notification Object and SMS Notification Object.                                                                     |
| Action                                               | Stop recording user information - Vigor router system will stop to record the user information onto USB disk.<br>Backup and clean up all user info, and start a new record - Vigor router system will backup all existed information on the USB disk onto the host and clean up the information from USB disk. Later, it will start a new record. |
| <b>Advanced options</b>                              |                                                                                                                                                                                                                                                                                                                                                   |
| Database Encryption                                  | Select to have the router create a new encrypted database. Once this is done, you will not be able to revert to an unencrypted database.                                                                                                                                                                                                          |

## VII-4-3 Quota Management

The system administrator can specify bandwidth and sessions quota which is only applicable to the web portal clients.

Settings configured in Quota Management will override the policies set in Bandwidth Management>>Bandwidth Limit and Bandwidth Management>>Limit.

Hotspot Web Portal >> Quota Management

### Web Portal Bandwidth and Session Limit

The settings here will apply only to the web portal clients and will override the policies set in Bandwidth Management.

Bandwidth Limit

Session Limit

### Quota Policy Profile

| Index                                         | Name    | Expired Time after First Login | Device Allowed per Account | Reconnection Time Restriction | Bandwidth Limit | Session Limit |
|-----------------------------------------------|---------|--------------------------------|----------------------------|-------------------------------|-----------------|---------------|
| 1                                             | Default | 0d 5h 0m                       | Unlimited                  | Unlimited                     | Unlimited       | Unlimited     |
| <input type="button" value="Add"/> (up to 20) |         |                                |                            |                               |                 |               |

Available settings are explained as follows:

| Item                 | Description                                                                               |
|----------------------|-------------------------------------------------------------------------------------------|
| Bandwidth Limit      | Check the box to override the policy configured in Bandwidth Management>>Bandwidth Limit. |
| Session Limit        | Check the box to override the policy configured in Bandwidth Management>>Session Limit.   |
| Quota Policy Profile | Add - Create up to 20 policy profiles in such page.                                       |

To create a new quota policy profile, click Add to open the following page.

Hotspot Web Portal >> Management >> Quota Policy Profile 2

Profile Name

---

**Account Validity**

Expired Time After the First Login  days  hours  min

Idle Timeout  min

---

**Device Control**

Devices Allowed per account

Reconnection Time Restriction  At  :  everyday  
Block the same user from reconnecting before the set time

hours  min  
Block the same user from reconnecting for the set period

---

**Bandwidth and Session Limit**

Bandwidth Limit

Download Limit   Kbps  Mbps

Upload Limit   Kbps  Mbps

Session Limit  sessions

Available settings are explained as follows:

| Item                        | Description                                                                                                                                                                                                                                                                                                                                                                                                                                                                                                                                                                                                                                                                                                                                                                       |
|-----------------------------|-----------------------------------------------------------------------------------------------------------------------------------------------------------------------------------------------------------------------------------------------------------------------------------------------------------------------------------------------------------------------------------------------------------------------------------------------------------------------------------------------------------------------------------------------------------------------------------------------------------------------------------------------------------------------------------------------------------------------------------------------------------------------------------|
| Profile Name                | Enter a name for a new profile.                                                                                                                                                                                                                                                                                                                                                                                                                                                                                                                                                                                                                                                                                                                                                   |
| Account Validity            | Set the duration for which the login is valid.<br>Expired Time After the First Login - Sets the days, hours, and minutes. After the login has expired, Vigor router will block the client from accessing the network/Internet.<br>Idle Timeout - When this option is selected, Vigor router will terminate the network connection if there is no activity from the user after the specified idle time has passed.                                                                                                                                                                                                                                                                                                                                                                 |
| Device Control              | Set the maximum number of devices that can be connected for each account, and the time restriction for the client accessing Internet via the web portal.<br>Devices Allowed per account - Use the drop-down list to select the maximum number of devices that can be connected to the network using the same account.<br>Reconnection Time Restriction - Blocks the account from being used to connect devices to the network in one of two ways: <ul style="list-style-type: none"> <li>● At ... Everyday - After the login expires, the account cannot be used to connect devices to the network until the set time of day.</li> <li>● Hours.. min - After the login expires, the account cannot be used to connect devices to the network for a set period of time.</li> </ul> |
| Bandwidth and Session Limit | Bandwidth Limit - Check the box to configure bandwidth limit for web portal client.                                                                                                                                                                                                                                                                                                                                                                                                                                                                                                                                                                                                                                                                                               |



|  |                                                                                                                                                                                                                         |
|--|-------------------------------------------------------------------------------------------------------------------------------------------------------------------------------------------------------------------------|
|  | <ul style="list-style-type: none"><li>● Download/Upload Limits - Set the maximum upload and download speeds.</li></ul> <p>Session Limit- Check the box to configure a maximum session limit for web portal clients.</p> |
|--|-------------------------------------------------------------------------------------------------------------------------------------------------------------------------------------------------------------------------|

After finishing all the settings here, please click OK to save the configuration.

## VII-4-4 PIN Generator

The system administrator can generate multiple PIN codes for various usage. Before generating PIN codes, please make sure a USB has been inserted onto your Vigor device.

### VII-4-4-1 PIN Status

This page displays the PIN codes generated by PIN Generator.

Hotspot Web Portal >> PIN Generator

| PIN Status     |            | PIN Generator                                                                          |              | JSON PIN Generator                                              |                                             | PIN Voucher                                   |             |
|----------------|------------|----------------------------------------------------------------------------------------|--------------|-----------------------------------------------------------------|---------------------------------------------|-----------------------------------------------|-------------|
| Filter         |            |                                                                                        |              |                                                                 |                                             |                                               |             |
| Profile        | Batch Name | Status                                                                                 | Quota Policy | PIN                                                             | Expiry Time                                 |                                               |             |
| ALL ▾          | ALL ▾      | <input checked="" type="checkbox"/> Unused<br><input checked="" type="checkbox"/> Used | ALL ▾        | <input type="text"/>                                            | <input checked="" type="checkbox"/> Expired | <input checked="" type="checkbox"/> Unexpired |             |
| OK             |            |                                                                                        |              |                                                                 |                                             |                                               |             |
| Showing ▾ of 0 |            |                                                                                        |              | <a href="#">Export to CSV File</a>   <a href="#">Delete All</a> |                                             |                                               |             |
| PIN            | Profile    | Status                                                                                 | Batch Name   | Valid Through                                                   | Quota Policy                                | Activated On                                  | Expiry Time |
| 004840         | 1          | Unused                                                                                 | Hotel_1      | 2000-01-09 00:52:07                                             | 1-Default                                   |                                               | X           |
| 006240         | 1          | Unused                                                                                 | Hotel_1      | 2000-01-09 00:52:07                                             | 1-Default                                   |                                               | X           |
| 006608         | 1          | Unused                                                                                 | Hotel_1      | 2000-01-09 00:52:07                                             | 1-Default                                   |                                               | X           |
| 010523         | 1          | Unused                                                                                 | Hotel_1      | 2000-01-09 00:52:07                                             | 1-Default                                   |                                               | X           |
| 011391         | 1          | Unused                                                                                 | Hotel_1      | 2000-01-09 00:52:07                                             | 1-Default                                   |                                               | X           |
| 014507         | 1          | Unused                                                                                 | Hotel_1      | 2000-01-09 00:52:07                                             | 1-Default                                   |                                               | X           |
| 015771         | 1          | Unused                                                                                 | Hotel_1      | 2000-01-09 00:52:07                                             | 1-Default                                   |                                               | X           |
| 017016         | 1          | Unused                                                                                 | Hotel_1      | 2000-01-09 00:52:07                                             | 1-Default                                   |                                               | X           |
| 018167         | 1          | Unused                                                                                 | Hotel_1      | 2000-01-09 00:52:07                                             | 1-Default                                   |                                               | X           |
| 024084         | 1          | Unused                                                                                 | Hotel_1      | 2000-01-09 00:52:07                                             | 1-Default                                   |                                               | X           |
| 028484         | 1          | Unused                                                                                 | Hotel_1      | 2000-01-09 00:52:07                                             | 1-Default                                   |                                               | X           |

Available settings are explained as follows:

| Item               | Description                                                                                                                                                                              |
|--------------------|------------------------------------------------------------------------------------------------------------------------------------------------------------------------------------------|
| Profile            | Use the drop down menu to choose an index number (1 to 4) for PIN generator profile.                                                                                                     |
| Batch Name         | Use the drop down menu to choose an existed PIN profile or choose ALL to display the PIN status.                                                                                         |
| Status             | Unused - After checking the box, only the unused PIN codes will be shown on this page.<br>Used - After checking the box, only the used PIN codes will be shown on this page.             |
| Quota Policy       | Use the drop down menu to choose a quota management policy to display related PIN codes.                                                                                                 |
| PIN                | Enter the PIN code to display related information on this page.                                                                                                                          |
| Expiry Time        | Expired - After checking the box, only the expired PIN codes will be shown on this page.<br>Unexpired - After checking the box, only the unexpired PIN codes will be shown on this page. |
| OK                 | Click it to display the PIN code according to the above filtering condition.                                                                                                             |
| Export to CSV File | Click it to export the configuration of PIN code as a CSV file.                                                                                                                          |

## VII-4-4-2 PIN Generator

The system administrator can generate multiple PIN codes in response to the user's (e.g., enterprise) demand.

Hotspot Web Portal >> PIN Generator

| PIN Status                              | PIN Generator                                            | JSON PIN Generator            | PIN Voucher                |                               |                          |               |
|-----------------------------------------|----------------------------------------------------------|-------------------------------|----------------------------|-------------------------------|--------------------------|---------------|
| Profile                                 | 1 ▾                                                      |                               |                            |                               |                          |               |
| Batch Name                              | <input type="text"/>                                     |                               |                            |                               |                          |               |
| PIN code length                         | 6 ▾ digits                                               |                               |                            |                               |                          |               |
| PIN Validity                            | 1 ▾ days 0 ▾ hours                                       |                               |                            |                               |                          |               |
|                                         | The period of time the PIN will be kept in the database. |                               |                            |                               |                          |               |
| Quantity                                | <input type="text"/>                                     |                               |                            |                               |                          |               |
| Quota Management Policy                 | 1-Default ▾                                              |                               |                            |                               |                          |               |
| Index                                   | Name                                                     | Expired Time after Activation | Device Allowed per Account | Reconnection Time Restriction | Download Bandwidth Limit | Session Limit |
| 1                                       | Default                                                  | 0d 5h 0m                      | Unlimited                  | Unlimited                     | Unlimited                | Unlimited     |
| <input type="button" value="Generate"/> |                                                          |                               |                            |                               |                          |               |

**Note:**

Please set up [Database](#) to start generating PIN codes.

If you want to get pin code from Internet, please set up [Internet Access Control](#).

Available settings are explained as follows:

| Item                    | Description                                                                                                                                                                                                                                                                                                                                                                                                                                                                                                                                                                                                                                                                                                                                                                                                                                                                                                                                                                                                                            |                               |                            |                               |                            |                               |                          |               |   |         |          |           |           |           |           |
|-------------------------|----------------------------------------------------------------------------------------------------------------------------------------------------------------------------------------------------------------------------------------------------------------------------------------------------------------------------------------------------------------------------------------------------------------------------------------------------------------------------------------------------------------------------------------------------------------------------------------------------------------------------------------------------------------------------------------------------------------------------------------------------------------------------------------------------------------------------------------------------------------------------------------------------------------------------------------------------------------------------------------------------------------------------------------|-------------------------------|----------------------------|-------------------------------|----------------------------|-------------------------------|--------------------------|---------------|---|---------|----------|-----------|-----------|-----------|-----------|
| Profile                 | Use the drop down menu to specify an index number (from 1 to 4).                                                                                                                                                                                                                                                                                                                                                                                                                                                                                                                                                                                                                                                                                                                                                                                                                                                                                                                                                                       |                               |                            |                               |                            |                               |                          |               |   |         |          |           |           |           |           |
| Batch Name              | Enter a string as a batch name.                                                                                                                                                                                                                                                                                                                                                                                                                                                                                                                                                                                                                                                                                                                                                                                                                                                                                                                                                                                                        |                               |                            |                               |                            |                               |                          |               |   |         |          |           |           |           |           |
| PIN code length         | Specify the length of PIN code.                                                                                                                                                                                                                                                                                                                                                                                                                                                                                                                                                                                                                                                                                                                                                                                                                                                                                                                                                                                                        |                               |                            |                               |                            |                               |                          |               |   |         |          |           |           |           |           |
| PIN Validity            | Set the period of time.                                                                                                                                                                                                                                                                                                                                                                                                                                                                                                                                                                                                                                                                                                                                                                                                                                                                                                                                                                                                                |                               |                            |                               |                            |                               |                          |               |   |         |          |           |           |           |           |
| Quantity                | Set the quantity of the PIN code.                                                                                                                                                                                                                                                                                                                                                                                                                                                                                                                                                                                                                                                                                                                                                                                                                                                                                                                                                                                                      |                               |                            |                               |                            |                               |                          |               |   |         |          |           |           |           |           |
| Quota Management Policy | Use the drop down list to choose policy profile.                                                                                                                                                                                                                                                                                                                                                                                                                                                                                                                                                                                                                                                                                                                                                                                                                                                                                                                                                                                       |                               |                            |                               |                            |                               |                          |               |   |         |          |           |           |           |           |
| Generate                | <p>Click it to generate a PIN code as a voucher.</p> <p>The system will ask you to set up <a href="#">Database</a> before executing the generation.</p> <div style="border: 1px solid black; padding: 5px; margin: 5px 0;"> <p>Quota Management Policy <span style="float: right;">1-Default ▾</span></p> <p style="text-align: center;"><input type="button" value="Generate"/></p> <table border="1" style="width: 100%; border-collapse: collapse;"> <thead> <tr> <th>Index</th> <th>Name</th> <th>Expired Time after Activation</th> <th>Device Allowed per Account</th> <th>Reconnection Time Restriction</th> <th>Download Bandwidth Limit</th> <th>Session Limit</th> </tr> </thead> <tbody> <tr> <td>1</td> <td>Default</td> <td>0d 5h 0m</td> <td>Unlimited</td> <td>Unlimited</td> <td>Unlimited</td> <td>Unlimited</td> </tr> </tbody> </table> <p style="text-align: center;"><input type="button" value="Generate"/></p> </div> <p><small>Note:</small></p> <p>Later, available PIN code will be shown on PIN Status.</p> | Index                         | Name                       | Expired Time after Activation | Device Allowed per Account | Reconnection Time Restriction | Download Bandwidth Limit | Session Limit | 1 | Default | 0d 5h 0m | Unlimited | Unlimited | Unlimited | Unlimited |
| Index                   | Name                                                                                                                                                                                                                                                                                                                                                                                                                                                                                                                                                                                                                                                                                                                                                                                                                                                                                                                                                                                                                                   | Expired Time after Activation | Device Allowed per Account | Reconnection Time Restriction | Download Bandwidth Limit   | Session Limit                 |                          |               |   |         |          |           |           |           |           |
| 1                       | Default                                                                                                                                                                                                                                                                                                                                                                                                                                                                                                                                                                                                                                                                                                                                                                                                                                                                                                                                                                                                                                | 0d 5h 0m                      | Unlimited                  | Unlimited                     | Unlimited                  | Unlimited                     |                          |               |   |         |          |           |           |           |           |

Hotspot Web Portal >> PIN Generator

PIN Status    PIN Generator    PIN Voucher

Filter

| Profile | Batch Name | Status                                                                                 | Quota Policy | PIN | Expiry Time                                                                                  |
|---------|------------|----------------------------------------------------------------------------------------|--------------|-----|----------------------------------------------------------------------------------------------|
| ALL     | ALL        | <input checked="" type="checkbox"/> Unused<br><input checked="" type="checkbox"/> Used | ALL          |     | <input checked="" type="checkbox"/> Expired<br><input checked="" type="checkbox"/> Unexpired |

OK

Showing 1-50 of 500 | [Export to CSV File](#) | [Delete All](#)

| PIN    | Profile | Status | Batch Name | Valid Through       | Quota Policy | Activated On | Expiry Time |
|--------|---------|--------|------------|---------------------|--------------|--------------|-------------|
| 004840 | 1       | Unused | Hotel_1    | 2000-01-09 00:52:07 | 1-Default    |              | X           |
| 006240 | 1       | Unused | Hotel_1    | 2000-01-09 00:52:07 | 1-Default    |              | X           |
| 006608 | 1       | Unused | Hotel_1    | 2000-01-09 00:52:07 | 1-Default    |              | X           |
| 010523 | 1       | Unused | Hotel_1    | 2000-01-09 00:52:07 | 1-Default    |              | X           |
| 011391 | 1       | Unused | Hotel_1    | 2000-01-09 00:52:07 | 1-Default    |              | X           |
| 014507 | 1       | Unused | Hotel_1    | 2000-01-09 00:52:07 | 1-Default    |              | X           |
| 015771 | 1       | Unused | Hotel_1    | 2000-01-09 00:52:07 | 1-Default    |              | X           |
| 017016 | 1       | Unused | Hotel_1    | 2000-01-09 00:52:07 | 1-Default    |              | X           |
| 018167 | 1       | Unused | Hotel_1    | 2000-01-09 00:52:07 | 1-Default    |              | X           |
| 024084 | 1       | Unused | Hotel_1    | 2000-01-09 00:52:07 | 1-Default    |              | X           |
| 028484 | 1       | Unused | Hotel_1    | 2000-01-09 00:52:07 | 1-Default    |              | X           |
| 032141 | 1       | Unused | Hotel_1    | 2000-01-09 00:52:07 | 1-Default    |              | X           |
| 034187 | 1       | Unused | Hotel_1    | 2000-01-09 00:52:07 | 1-Default    |              | X           |
| 035052 | 1       | Unused | Hotel_1    | 2000-01-09 00:52:07 | 1-Default    |              | X           |
| 036565 | 1       | Unused | Hotel_1    | 2000-01-09 00:52:07 | 1-Default    |              | X           |
| 038569 | 1       | Unused | Hotel_1    | 2000-01-09 00:52:07 | 1-Default    |              | X           |
| 040262 | 1       | Unused | Hotel_1    | 2000-01-09 00:52:07 | 1-Default    |              | X           |
| 042268 | 1       | Unused | Hotel_1    | 2000-01-09 00:52:07 | 1-Default    |              | X           |
| 048446 | 1       | Unused | Hotel_1    | 2000-01-09 00:52:07 | 1-Default    |              | X           |
| 048842 | 1       | Unused | Hotel_1    | 2000-01-09 00:52:07 | 1-Default    |              | X           |
| 050503 | 1       | Unused | Hotel_1    | 2000-01-09 00:52:07 | 1-Default    |              | X           |
| 053852 | 1       | Unused | Hotel_1    | 2000-01-09 00:52:07 | 1-Default    |              | X           |
| 053935 | 1       | Unused | Hotel_1    | 2000-01-09 00:52:07 | 1-Default    |              | X           |
| 054543 | 1       | Unused | Hotel_1    | 2000-01-09 00:52:07 | 1-Default    |              | X           |
| 059971 | 1       | Unused | Hotel_1    | 2000-01-09 00:52:07 | 1-Default    |              | X           |
| 064680 | 1       | Unused | Hotel_1    | 2000-01-09 00:52:07 | 1-Default    |              | X           |

### VII-4-4-3 JSON PIN Generator

The system administrator can generate JSON PIN codes in response to the user's (e.g., enterprise) demand.

Hotspot Web Portal >> PIN Generator

PIN Status    PIN Generator    **JSON PIN Generator**    PIN Voucher

Enable HTTPS API to get PIN code  
 Authorization Code:

Get PIN from Internet ●

Enable authorize by IP Object/IPv6 Object

| IP Object |                 | IPv6 Object |                 |
|-----------|-----------------|-------------|-----------------|
| List      | IP Filter Index | List        | IP Filter Index |
| 1         | None            | 1           | None            |
| 2         | None            | 2           | None            |
| 3         | 1-RD Department | 3           | None            |
| 4         | None            | 4           | None            |
| 5         | None            | 5           | None            |
| 6         | None            | 6           | None            |
| 7         | None            | 7           | None            |
| 8         | None            | 8           | None            |
| 9         | None            | 9           | None            |
| 10        | None            | 10          | None            |

OK    Cancel

Note:

Please set up [Database](#) to start generating PIN codes.

If you want to get pin code from Internet, please set up [Internet Access Control](#).

Available settings are explained as follows:

| Item                             | Description                            |
|----------------------------------|----------------------------------------|
| Enable HTTPS API to get PIN code | Check the box to enable the HTTPS API. |

|                                           |                                                                                                                                                                  |
|-------------------------------------------|------------------------------------------------------------------------------------------------------------------------------------------------------------------|
| Authorization Code                        | Enter a string as identity authentication.                                                                                                                       |
| Get PIN from Internet                     | Check the box to get the PIN code from the Internet.<br>Before selecting, make sure the HTTPS Server option be enabled on System Maintenance>>Management.        |
| Enable authorize by IP Object/IPv6 Object | Check the box to enable the authentication based on the IP/IPv6 object.<br>IP Filter Index - Use the drop-down list to select IP filter (IP object/IPv6 object). |

#### VII-4-4-4 PIN Voucher

This page allows to print out the PIN code list.

Hotspot Web Portal >> PIN Generator

| PIN Status                                              | PIN Generator                                                                                                                                                                                                                  | JSON PIN Generator | PIN Voucher |
|---------------------------------------------------------|--------------------------------------------------------------------------------------------------------------------------------------------------------------------------------------------------------------------------------|--------------------|-------------|
| Profile                                                 | 1                                                                                                                                                                                                                              |                    |             |
| Batch                                                   | (Unused Only)                                                                                                                                                                                                                  |                    |             |
| <input checked="" type="checkbox"/> Voucher Title       |                                                                                                                                                                                                                                |                    |             |
| <input checked="" type="checkbox"/> Show Quota Policy   | <input checked="" type="checkbox"/> Expired Time after first login <input checked="" type="checkbox"/> Device Allowed<br><input checked="" type="checkbox"/> Bandwidth Limit <input checked="" type="checkbox"/> Session Limit |                    |             |
| <input checked="" type="checkbox"/> Message             |                                                                                                                                                                                                                                |                    |             |
| <input checked="" type="checkbox"/> Show Valid Date     |                                                                                                                                                                                                                                |                    |             |
| <input checked="" type="checkbox"/> Use Default Setting |                                                                                                                                                                                                                                |                    |             |
| Column                                                  | 3                                                                                                                                                                                                                              |                    |             |
| Height                                                  |                                                                                                                                                                                                                                |                    |             |
| Width                                                   |                                                                                                                                                                                                                                |                    |             |
| Preview and Print                                       |                                                                                                                                                                                                                                |                    |             |

Available settings are explained as follows:

| Item                | Description                                                                                                                                                                                                                                                                                                                                         |
|---------------------|-----------------------------------------------------------------------------------------------------------------------------------------------------------------------------------------------------------------------------------------------------------------------------------------------------------------------------------------------------|
| Profile             | Use the drop down menu to specify an index number (from 1 to 4).                                                                                                                                                                                                                                                                                    |
| Batch               | Use the drop down menu to specify an unused batch profile.                                                                                                                                                                                                                                                                                          |
| Voucher Title       | Enter a string as a title which will be shown on a print out paper.                                                                                                                                                                                                                                                                                 |
| Show Quota Policy   | Choose the item(s) to be shown on the print-out PIN code list.                                                                                                                                                                                                                                                                                      |
| Message             | Enter a brief description that the client should know.                                                                                                                                                                                                                                                                                              |
| Show Valid Date     | Check the box to display the valid date and time on the printed out list.                                                                                                                                                                                                                                                                           |
| Use Default Setting | <p>If enabled, the system will use the default setting of paper size for printing the label.</p> <p>If disabled, set the paper size for printing the vouchers on label printer.</p> <p>Column - Use the drop-down list to specify the column value.</p> <p>Height - Enter the value of the height.</p> <p>Width - Enter the value of the width.</p> |

Preview and Print

Click it to display the PIN code list. This list can be printed out if required.

The screenshot shows a web browser window with the address bar displaying "192.168.1.1/doc/hspinprint.htm - Google Chrome". The page content is organized into a 2x3 grid of panels, each representing a hotel's configuration. Each panel contains the following information:

- Hotel Name:** HOTEL
- PIN Code:** 947098, 519177, 744387 (top row); 852367, 503698, 846024 (bottom row)
- Expired Time:** 5 hours
- Device Allowed:** Unlimited
- Speed Limit:** Download Unlimited, Upload Unlimited
- Session Limit:** Unlimited
- Message Display:** what kind of message shall be shown on the screen?
- Valid Through:** 2000-01-09 00:52:07

---

## Application Notes

### A-1 How to create Facebook APP for Web Portal Authentication?

The new web portal feature support social login as authentication method, and allows network administrator to authenticate LAN clients by their Google or Facebook account. This document introduces how to create Facebook APP, and generate the APP ID and APP secret that can be used in Web Portal setup.

1. Register as FB Developer: Go to <https://developers.facebook.com/> and login the FB account.
2. Register the Facebook account as a Developer (If the account has been verified previously, this step can be skipped.)
3. Click My Apps then choose Register as Developer.

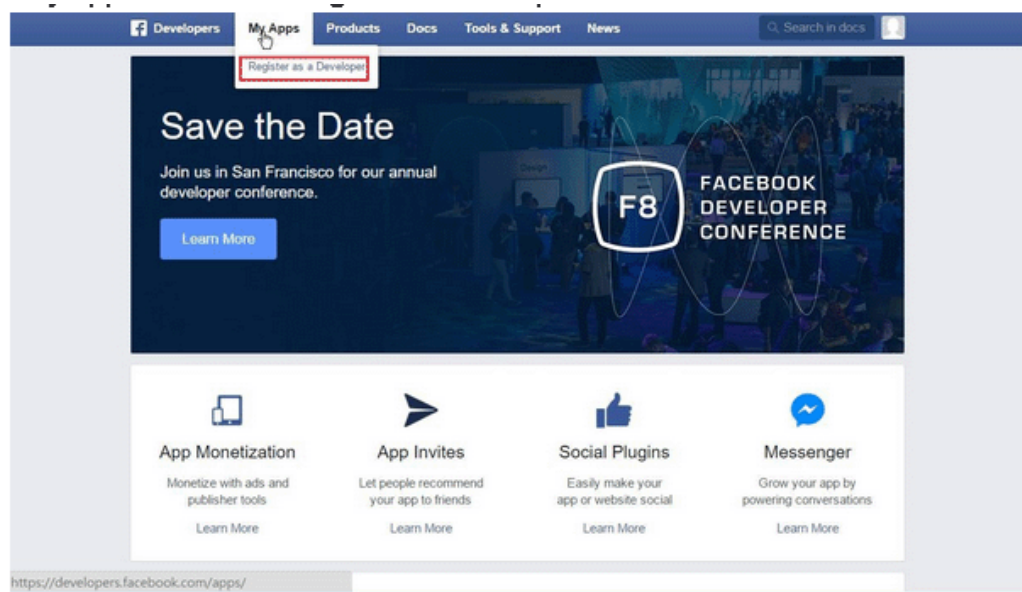

4. Switch to YES then click Next on pop-up window.



5. Choose country then type phone number, click Send as Text in Get Confirmation Code. Wait confirmation code message received then enter the confirmation code. Click Register to finish the register process.

**Register as a Facebook Developer** ✕

We need to verify your account to complete your registration. Your Phone number will be added to your timeline but won't be visible to your friends.

Country: Taiwan (+886) Phone number: 0912345678

Get Confirmation Code

Send as Text Send via Phone Call

Confirmation code: 625535

You can also verify your account by adding a credit card. [?]

Go Back Register

6. Add a New App. Click on My Apps > Add a New App. Choose Website platform.

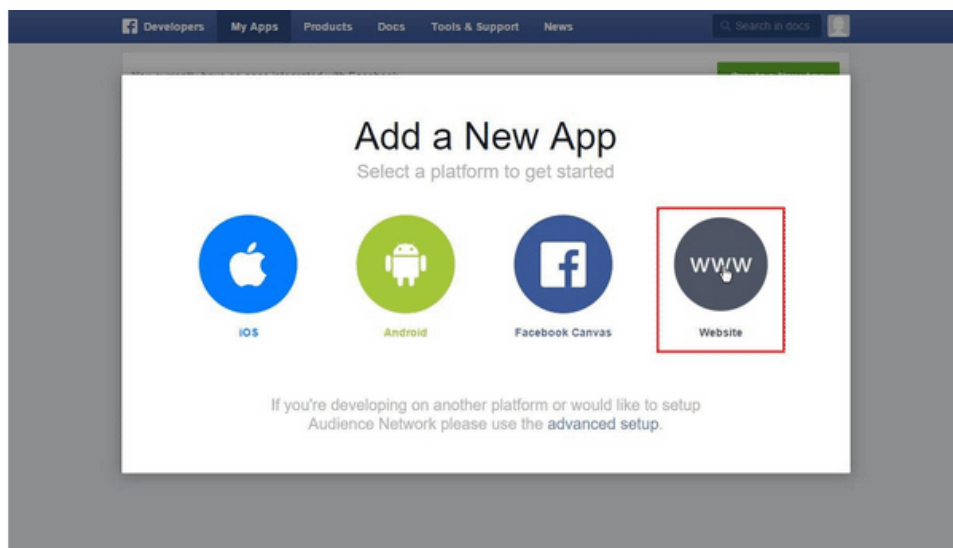

7. Click Skip and Create App ID on first use. Type Display Name. Choose Category. Click Create App ID.



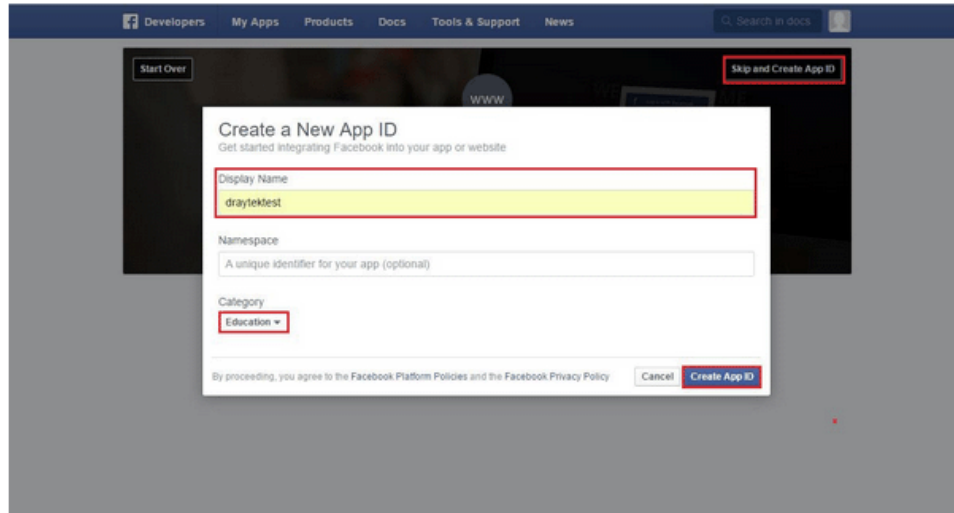

8. Pops up security check window, select the answer, and then click Submit to finish the process.



- On Dashboard, user can get App ID and App Secret, these information will be used in Vigor Router's Web Portal Setup.



- Add Platform on My Apps. Go to Settings then click Add Platform.

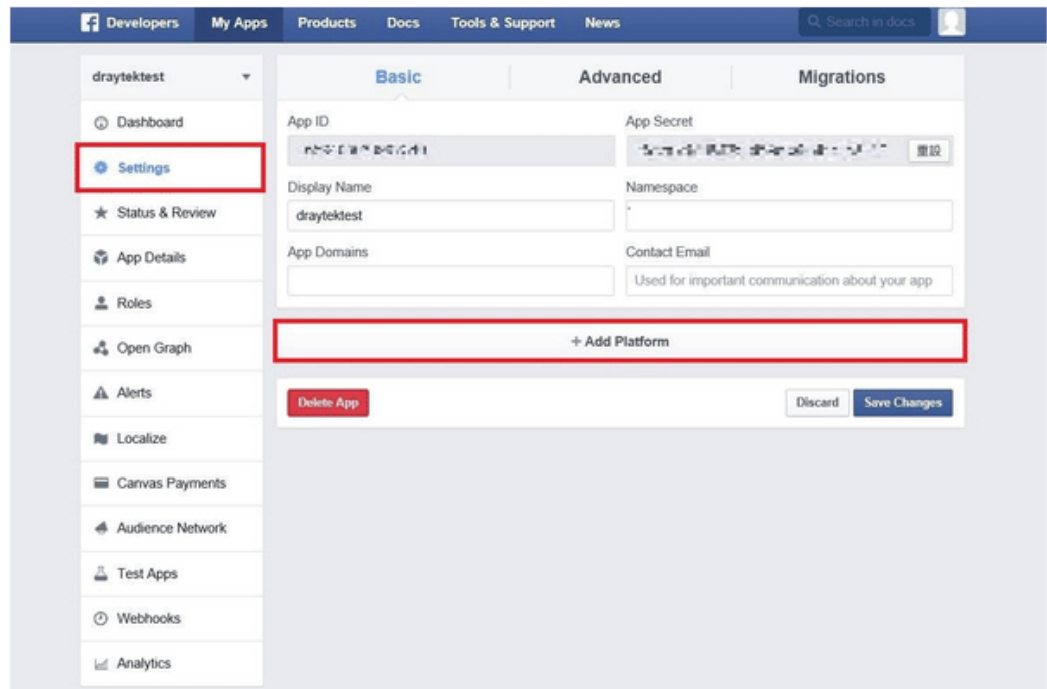

- Choose Website in Select Platform window.

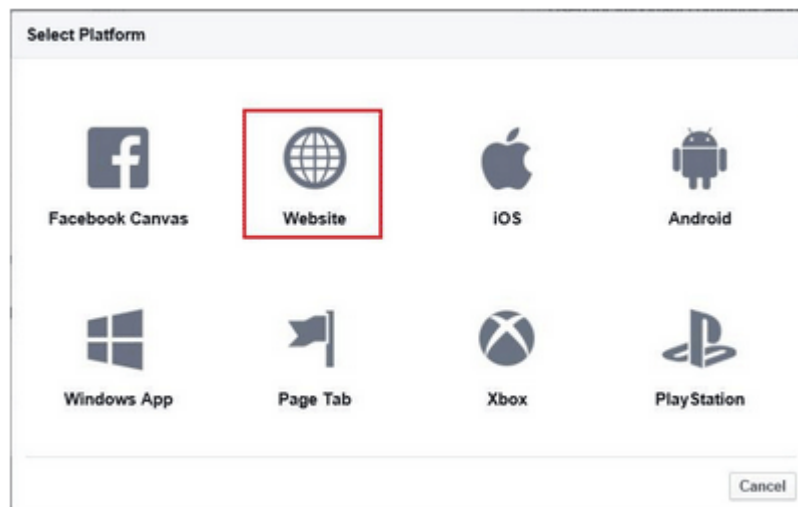

- Enter the Site URL as <http://portal.draytek.com>. (Note: If you change http port in the vigor, please add http port in URLs. For example, we use 8080 as http port and we'll put <http://portal.draytek.com:8080>). Enter the Contact Email. And click Save Change.

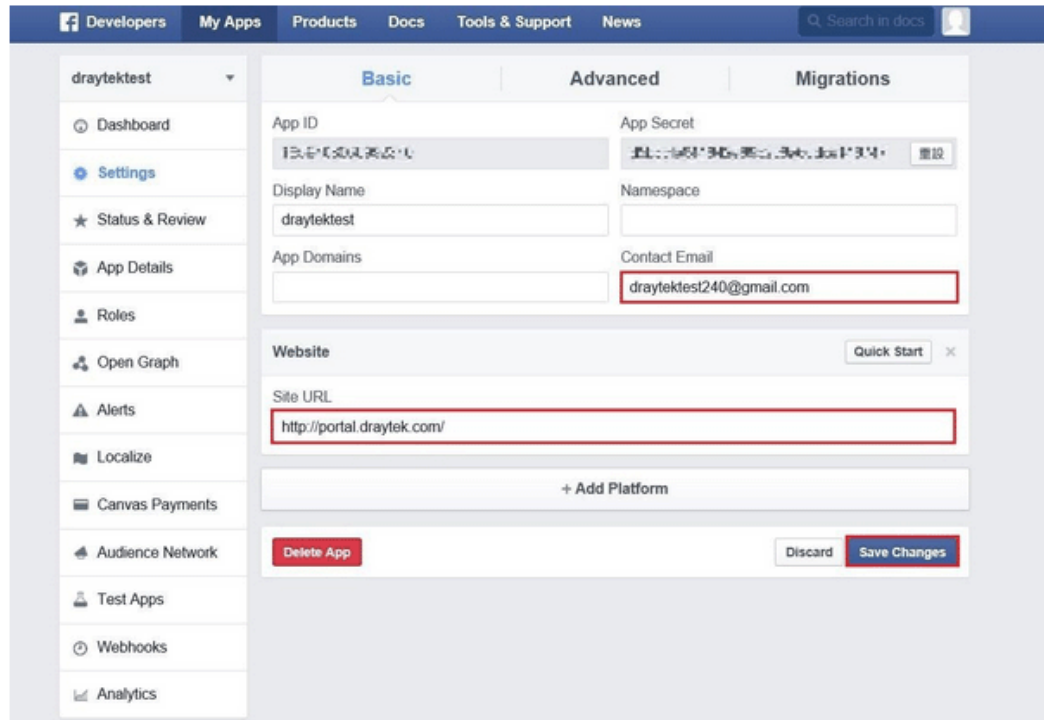

13. Set up Client OAuth. Go to Settings >> Advanced >> Client OAuth Settings, enter "http://portal.draytek.com" in Valid OAuth redirect URIs, and save changes.

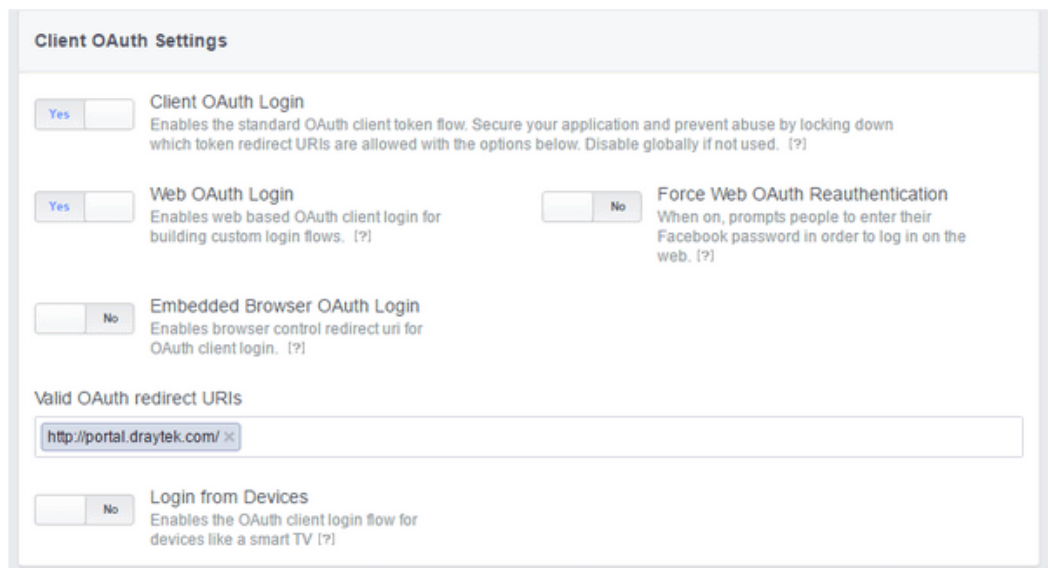

14. Go to My Apps >> Status & Review, and switch available status to YES to activate the APP.

Facebook Developers navigation bar: Developers, My Apps, Products, Docs, Tools & Support, News. Search in docs.

Left sidebar for 'draytektest': Dashboard, Settings, **Status & Review**, App Details, Roles, Open Graph, Alerts, Localize, Carvas Payments, Audience Network.

Main content area: **Status** | **Items in Review**

draytektest • Do you want to make this app and all its live features available to the general public?  YES

**Submit Items for Approval**  
Some Facebook integrations require approval before public usage. Before submitting your app for review, please consult our [Platform Policy and Review Guidelines](#).

**Approved Items** (0)

LOGIN PERMISSIONS

## A-2 How to create Google APP for Web Portal Authentication?

The new web portal feature support social login as authentication method, and allows network administrator to authenticate LAN clients by their Google or Facebook account. This document introduces how to create Facebook APP, and generate the APP ID and APP secret that can be used in Web Portal setup.

1. Create Developer project. Go to <https://code.google.com/apis/console>, login with a Google account then click Create project. Type project name then click Create.

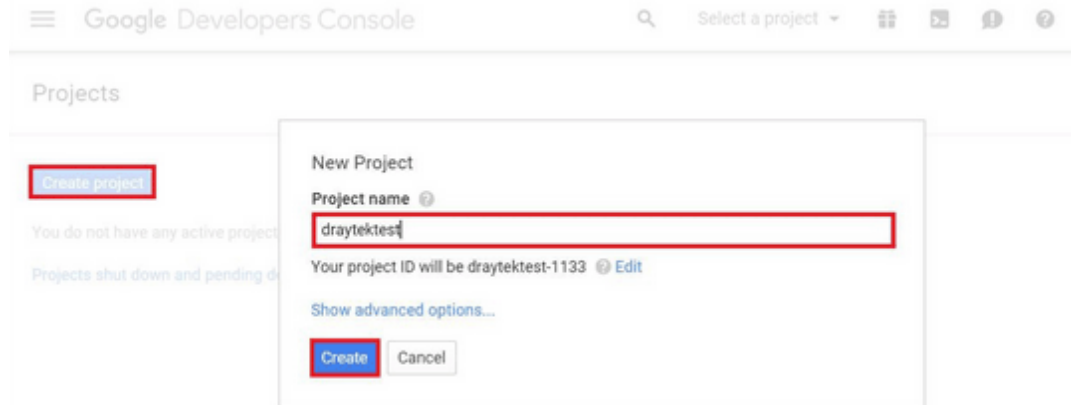

2. On Dashboard, choose Use Google APIs.

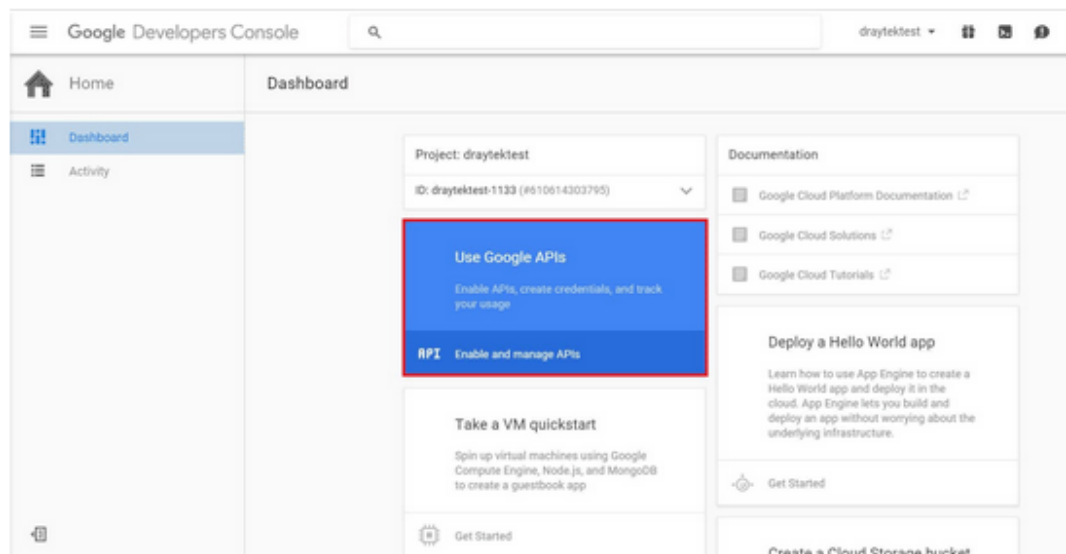

3. Edit Auth Consent screen. Go to Credentials > Auth consent screen. Enter your email, product name and other optional item then click on Save.

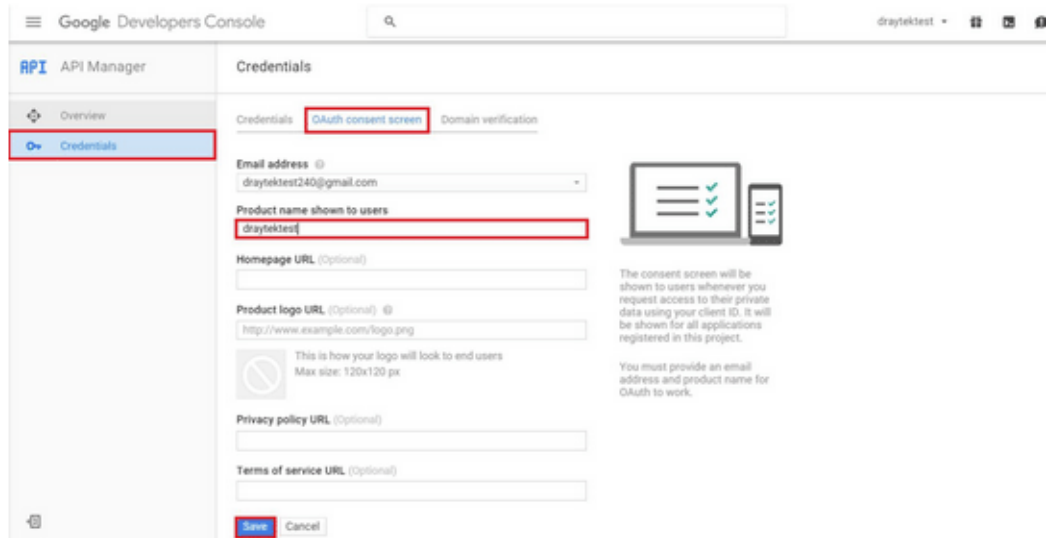

4. Create Client ID. Click Credentials and Click Add credentials > OAuth2.0 client ID.

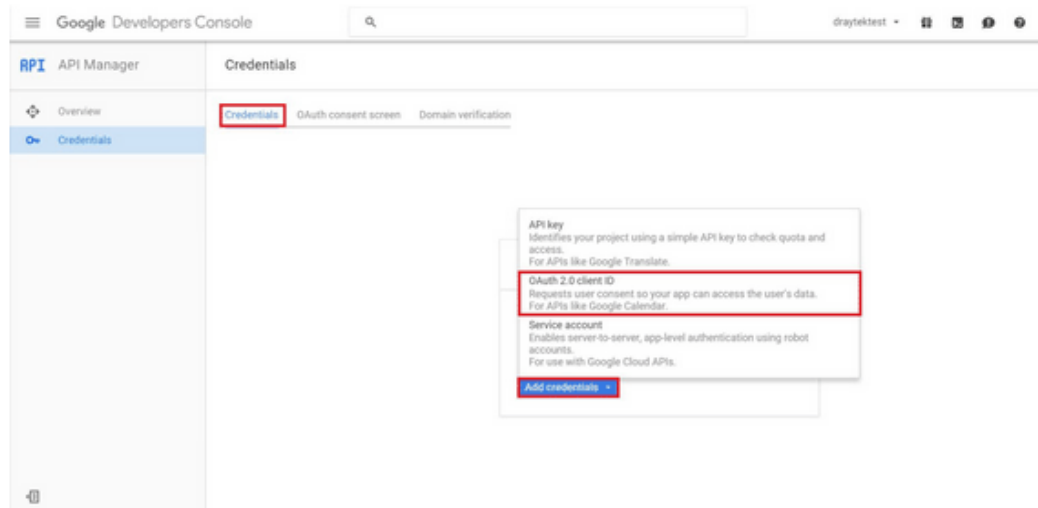

5. Choose Web application as Application Type, then enter name. Set Authorized JavaScript origins and Authorized redirect URLs as `http://portal.draytek.com`, and click Create. (*Note: If you change http port in the vigor, please add http port in URLs. For example, we use 8080 as http port and we'll put `http://portal.draytek.com:8080`*).
6. Get client ID and client secret. Such information will be used in Vigor Router's Web Portal Setup page.



---

## VII-5 Central Management (VPN)

Vigor2927 can build virtual private network (VPN) between itself and any other TR-069 CPE by the function of central VPN management. In addition, it can be treated as a server (called CVM server) which can manage TR-069 CPE for periodical firmware upgrade, configuration backup and restoring configuration.

### Central VPN Management

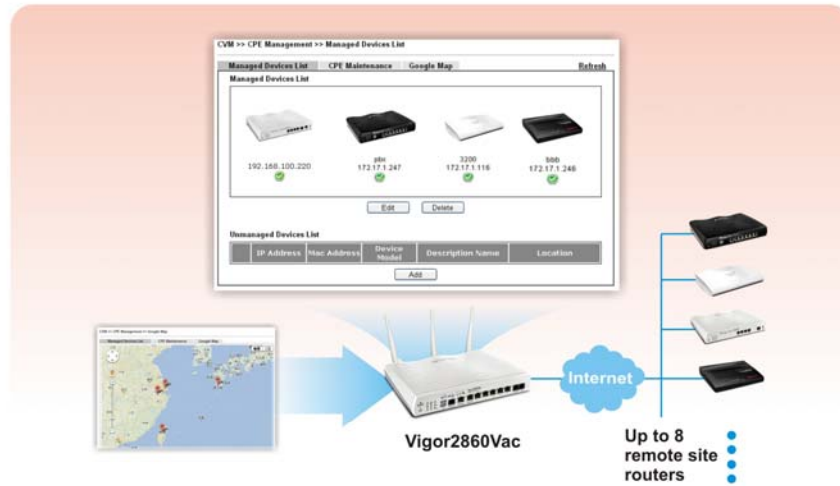

---

## Web User Interface

Central VPN Management menu can manage the CPE connected through WAN only.

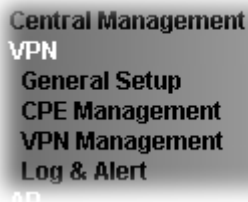

Central Management  
VPN  
General Setup  
CPE Management  
VPN Management  
Log & Alert  
AD

---

### VII-5-1 General Setup

This page is used to configure settings which will be used by the clients to register to such Vigor router. Click General Settings and IPsec VPN Settings to configure the basic settings for CVM mechanism.

#### VII-5-1-1 General Settings

To enable the CVM feature, the first thing you have to do is enabling CVM port or CVM SSL Port.

Central Management >> VPN >> General Setup

| General Settings                      | IPsec VPN Settings                                                   |
|---------------------------------------|----------------------------------------------------------------------|
| <input type="checkbox"/> CVM SSL Port | <input type="text" value="8443"/>                                    |
| <input type="checkbox"/> CVM Port     | <input type="text" value="8000"/>                                    |
| CVM WAN interface                     | <input type="text" value="WAN1"/> / <input type="text" value="---"/> |
| Username                              | <input type="text" value="acs"/>                                     |
| Password                              | <input type="password" value="....."/>                               |
| Polling Interval                      | <input type="text" value="600"/> Seconds                             |

**Note:**

At least one port (CVM SSL Port or CVM Port) must be enabled for CVM to be operational. Use "CVM SSL port" for maximum security as all traffic will be encrypted.

OK

Available settings are explained as follows:

| Item              | Description                                                                                                                                                                                               |
|-------------------|-----------------------------------------------------------------------------------------------------------------------------------------------------------------------------------------------------------|
| CVM SSL Port      | Check the box to enable the port setting.<br>Enter the port number in the box.                                                                                                                            |
| CVM Port          | Check the box to enable the port setting.<br>Enter the port number in the box.                                                                                                                            |
| CVM WAN interface | For Vigor router can manage only the client from WAN interface, therefore you have to specify which interface will be used for such function. If you choose MANUALLY, you have to specify WAN IP address. |
| Username          | Type a username which will be used by any CPE trying to                                                                                                                                                   |



|                  |                                                                      |
|------------------|----------------------------------------------------------------------|
|                  | connect to Vigor router.                                             |
| Password         | Enter the password for the user.                                     |
| Polling Interval | Enter the time value (unit is second). The range is from 60 ~ 86400. |

After finishing all the settings here, please click OK to save the configuration.

### VII-5-1-2 IPsec VPN Settings

Central VPN management is operated through IPsec VPN connection.

Central Management >> VPN >> General Setup

| General Settings                  | IPsec VPN Settings                                        |
|-----------------------------------|-----------------------------------------------------------|
| IPsec Mode:                       | Aggressive mode ▾                                         |
| Security Method:                  | ESP ▾                                                     |
| Encryption Type:                  | AES ▾                                                     |
| Local Subnet:                     | Manually ▾<br><input type="text"/> / <input type="text"/> |
| <input type="button" value="OK"/> |                                                           |

Available settings are explained as follows:

| Item            | Description                                                                                                                                                                                                                              |
|-----------------|------------------------------------------------------------------------------------------------------------------------------------------------------------------------------------------------------------------------------------------|
| IPsec Mode      | Choose Aggressive or Main as the IPsec Mode.                                                                                                                                                                                             |
| Security Method | Choose one of the following methods (AH or ESP) for the security of data transmission. For example, choose AH to specify the IPsec protocol for the Authentication Header protocol. The data will be authenticated but not be encrypted. |
| Encryption Type | Choose one of the selections as the encryption type.                                                                                                                                                                                     |
| Local Subnet    | Enter the IP address and subnet mask of local host.                                                                                                                                                                                      |

After finishing all the settings here, please click OK to save the configuration.

## VII-5-2 CPE Management

All the CPEs managed by Vigor2927 series can be seen with icons from this page.

Before using such feature, make sure the CVM port has been enabled and configured properly.

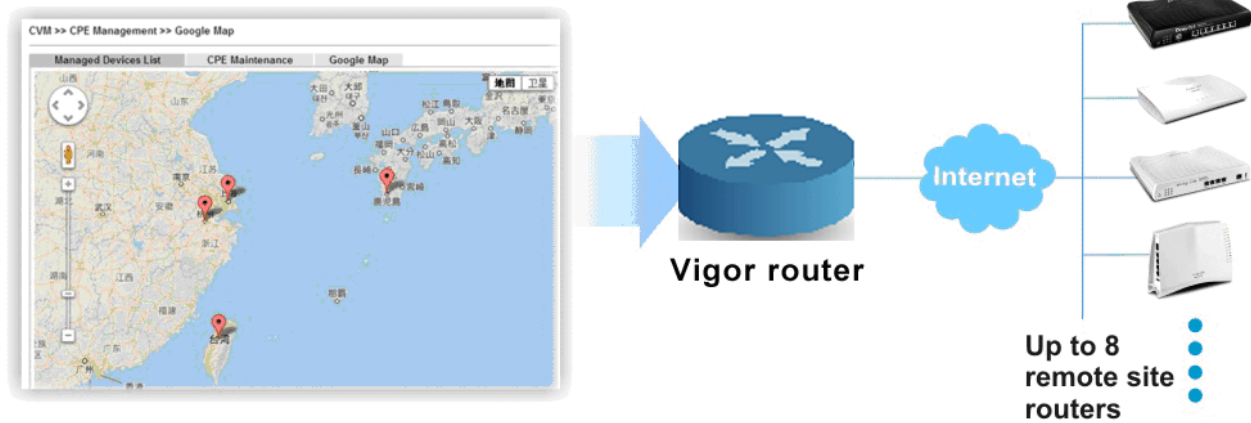

### VII-5-2-1 Managed Device List

This page allows you to manage the CPEs connected to Vigor2927 series.

#### Page without CPE connected

Central Management >> VPN >> CPE Management >> Managed Devices List

| Managed Devices List               | CPE Maintenance | Google Map   | <a href="#">Refresh</a> |          |
|------------------------------------|-----------------|--------------|-------------------------|----------|
| Managed Devices List               |                 |              |                         |          |
| Unmanaged Devices List             |                 |              |                         |          |
| IP Address                         | Mac Address     | Device Model | Description Name        | Location |
| <input type="button" value="Add"/> |                 |              |                         |          |

Page with CPE connected

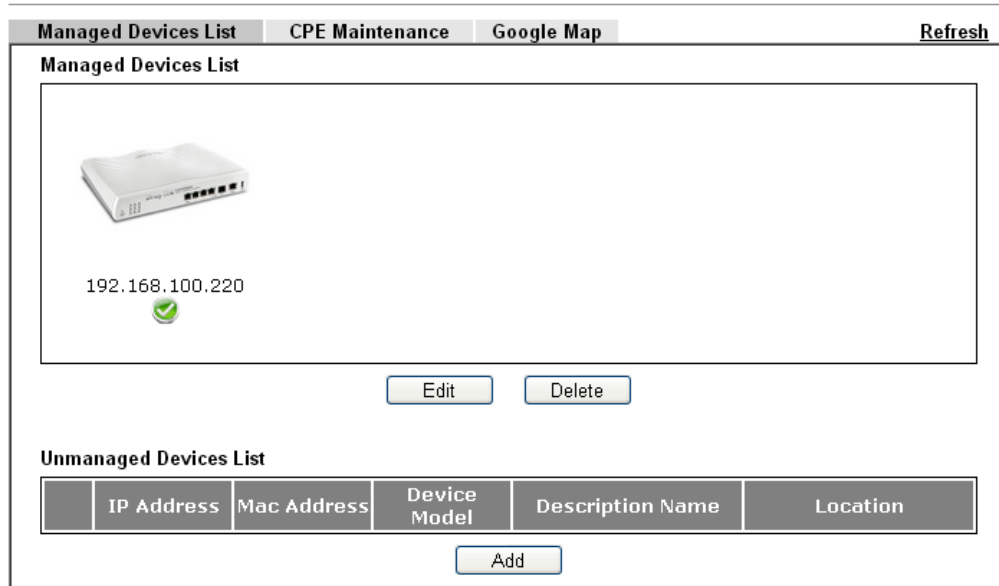

Available settings are explained as follows:

| Item                 | Description                                                                                                                                                                                                                                                                                                                                                                                                                                                                                                                                                                                                                      |
|----------------------|----------------------------------------------------------------------------------------------------------------------------------------------------------------------------------------------------------------------------------------------------------------------------------------------------------------------------------------------------------------------------------------------------------------------------------------------------------------------------------------------------------------------------------------------------------------------------------------------------------------------------------|
| Managed Devices List | <p>This area displays device icons (up to 8) for the CPE managed by Vigor2927 series.</p> <p><b>Edit</b> - To modify the name and location of specific CPE, click the one you want and click the Edit button. A pop up window will appear. Simply change the name and/or location manually.</p> <div data-bbox="679 1205 1410 1787" data-label="Image"> </div> <p><b>Delete</b> - To disconnect the management of any CPE, click the CPE icon you want and click the Delete button.</p> <p>Double-clicking the CPE icon also can pop up the Managed Device Detail window. However, you cannot modify any data on the window.</p> |

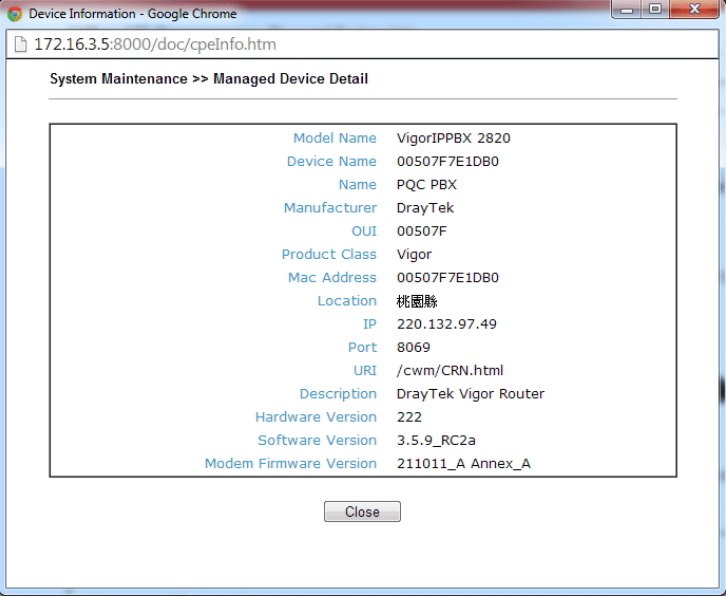
|                                      |                                                                                                                                                                                                                                                                                                                                                                                                                                                                                                                                                                                                                                                                                                                                                                                                                                                                                                       |
|--------------------------------------|-------------------------------------------------------------------------------------------------------------------------------------------------------------------------------------------------------------------------------------------------------------------------------------------------------------------------------------------------------------------------------------------------------------------------------------------------------------------------------------------------------------------------------------------------------------------------------------------------------------------------------------------------------------------------------------------------------------------------------------------------------------------------------------------------------------------------------------------------------------------------------------------------------|
|                                      |                                                                                                                                                                                                                                                                                                                                                                                                                                                                                                                                                                                                                                                                                                                                                                                                                     |
| <p><b>Unmanaged Devices List</b></p> | <p>Any device (CPE) which follows the standard of TR-069 can be configured and can be detected by Vigor2927 series automatically.</p> <p>Only eight remote devices can be managed by Vigor2927 at one time. Therefore, other remote devices detected by Vigor2927 series might not be displayed in such field.</p> <p><b>Add</b> - Move the selected device from Unmanaged Devices List to Managed Devices List.</p> <p><b>IP Address</b> - Display the IP address of the remote device.</p> <p><b>Mac Address</b> - Display the MAC address of the remote device.</p> <p><b>Device Model</b> - Display the model name of the remote device.</p> <p><b>Description Name</b> - Define the name or Enter the additional description of CPE for identification in VPN management and CPE management.</p> <p><b>Location</b> - Enter the location (address) of the CPE to be displayed by Google Map.</p> |
| <p><b>Refresh</b></p>                | <p>Click it to refresh current web page.</p>                                                                                                                                                                                                                                                                                                                                                                                                                                                                                                                                                                                                                                                                                                                                                                                                                                                          |

## VII-5-2-2 CPE Maintenance

This area displays all the profiles which are created for applying to the managed device. This page can help the administrator to do maintenance jobs like firmware upgrade, configuration backup, configuration restoration and etc.

Central Management >> VPN >> CPE Management >> CPE Maintenance

Refresh

Managed Devices List   CPE Maintenance   Google Map

USB Status: Disconnected   Disk Usage : ---   File Explorer

---

| [Set to Factory Default](#) |

| Index | Enable                   | Profile Name | Device Name | Action | Schedule                                   |
|-------|--------------------------|--------------|-------------|--------|--------------------------------------------|
| 1.    | <input type="checkbox"/> |              |             |        | 0,0 <span style="float: right;">Now</span> |
| 2.    | <input type="checkbox"/> |              |             |        | 0,0 <span style="float: right;">Now</span> |
| 3.    | <input type="checkbox"/> |              |             |        | 0,0 <span style="float: right;">Now</span> |
| 4.    | <input type="checkbox"/> |              |             |        | 0,0 <span style="float: right;">Now</span> |
| 5.    | <input type="checkbox"/> |              |             |        | 0,0 <span style="float: right;">Now</span> |
| 6.    | <input type="checkbox"/> |              |             |        | 0,0 <span style="float: right;">Now</span> |
| 7.    | <input type="checkbox"/> |              |             |        | 0,0 <span style="float: right;">Now</span> |
| 8.    | <input type="checkbox"/> |              |             |        | 0,0 <span style="float: right;">Now</span> |

<< 1-8 | 9-16 >>

**Note:**

1. USB storage must be connected before profiles can be enabled.
2. Click the "Now" button to execute the profile immediately.

Available settings are explained as follows:

| Item                   | Description                                                                                                                                                                                                                                                                                                                                                 |
|------------------------|-------------------------------------------------------------------------------------------------------------------------------------------------------------------------------------------------------------------------------------------------------------------------------------------------------------------------------------------------------------|
| Refresh                | Click it to refresh current page.                                                                                                                                                                                                                                                                                                                           |
| USB Disk               | USB Disk :  - It means a USB disk connecting to Vigor2927.<br>USB Disk :  - It means no USB disk connecting to Vigor2927.                                                                                                                                                                                                                                   |
| Disk Usage             | Disk Usage : <span style="color: green;">1084MB / 2009MB</span> - When a USB disk connects to Vigor2927, the disk usage and the disk capacity will be displayed in such field.<br>Disk Usage : <span style="color: red;">USB Storage Disconnected</span> - When there is no USB disk connecting to Vigor2927, such message will be displayed in this field. |
|                        | Click the icon to see the content inside the USB disk.                                                                                                                                                                                                                                                                                                      |
| Set to Factory Default | Click to clear all indexes.                                                                                                                                                                                                                                                                                                                                 |
| Index                  | Display the number of the profile that you can edit.                                                                                                                                                                                                                                                                                                        |
| Enable                 | Check to enable the profile.                                                                                                                                                                                                                                                                                                                                |
| Profile Name           | Display the name of the maintenance profile.                                                                                                                                                                                                                                                                                                                |

|             |                                                                                 |
|-------------|---------------------------------------------------------------------------------|
| Device Name | Display the name of the managed CPE that the maintenance profile will apply to. |
| Action      | Display the action that managed CPE shall accept.                               |
| Schedule    | Display the schedule profiles selected for such profile.                        |
| Now         | The action will be performed for the selected CPE immediately.                  |

### How to add a new Maintenance Profile

Follow the steps below to create a new maintenance profile.

1. Click any index number link, e.g., Index 1.
2. The Maintenance dialog appears.

Central VPN Management >> CPE Management >> Maintenance Profile

Enable     Only Run Once

Profile Name

Device Name

Router Name

Router Model

Action Type

File Name

**Schedule Profile**  ,

**Note:**

1. Enable "Only Run Once" to automatically disable the profile after it has been run.
2. The Action setting in the schedule profile will be ignored.



**Info**

When restoring configuration to a CPE, make sure the configuration file you selected was backup from this CPE before. Because restoring from another device's configuration file may cause serious problem (e.g., Both devices have different ISP username/ password. Restoring configuration from one CPE to the other will cause Internet connection not being online).

Available parameters are listed as follows:

| Item                         | Description                                                                                                                                           |
|------------------------------|-------------------------------------------------------------------------------------------------------------------------------------------------------|
| Enable                       | Check it to enable such profile.                                                                                                                      |
| Only Run Once                | Check it to activate such profile running for once.                                                                                                   |
| Profile Name                 | Enter the name of the maintenance profile.                                                                                                            |
| Device Name                  | The drop down list will display all the CPE devices detected by Vigor2927 series. Choose the one which will be applied with such new created profile. |
| Router Name/<br>Router Model | It displays the name and model of Vigor router.                                                                                                       |
| Action Type                  | There are three actions for you to choose for such profile.                                                                                           |

|                  |                                                                                                                                                                                                                                                                                                                                                                                                                                                                                                                                                                                                                                                                                                                                                                                                                                                                                                                                                                                          |
|------------------|------------------------------------------------------------------------------------------------------------------------------------------------------------------------------------------------------------------------------------------------------------------------------------------------------------------------------------------------------------------------------------------------------------------------------------------------------------------------------------------------------------------------------------------------------------------------------------------------------------------------------------------------------------------------------------------------------------------------------------------------------------------------------------------------------------------------------------------------------------------------------------------------------------------------------------------------------------------------------------------|
|                  | <ul style="list-style-type: none"> <li>● <b>Config Backup</b> - It means such profile will be used for configuration backup of the selected CPE.</li> <li>● <b>Config Restore</b> - It means such profile will be used for restoring the configuration of the selected CPE.</li> </ul> <div style="border: 1px solid black; padding: 5px; margin: 10px 0;">  <p><b>Info</b> When restoring configuration to a CPE, make sure the configuration file you selected was backup from this CPE before. Because restoring from another device's configuration file may cause serious problem (e.g., Both devices have different ISP username/ password. Restoring configuration from one CPE to the other will cause Internet connection not being online).</p> </div> <ul style="list-style-type: none"> <li>● <b>Firmware Upgrade</b> - It means such profile will be used for firmware upgrade.</li> </ul> |
| File Path        | When Config Restore is selected as Action Type, click Select to upload a configuration file from the connected USB disk. Later such file will be used for saving, restoring or firmware upgrade for CPE.                                                                                                                                                                                                                                                                                                                                                                                                                                                                                                                                                                                                                                                                                                                                                                                 |
| File Name        | Specify a file name in this field to save the configuration file when Config Backup is selected as Action Type.                                                                                                                                                                                                                                                                                                                                                                                                                                                                                                                                                                                                                                                                                                                                                                                                                                                                          |
| Schedule Profile | Vigor2927 series will perform the specified action to the selected CPE based on the schedule configured here. Specify one or two schedule profiles (represented by number) here.                                                                                                                                                                                                                                                                                                                                                                                                                                                                                                                                                                                                                                                                                                                                                                                                         |

3. Enter all the settings and click OK.
4. A new maintenance profile has been created.

### VII-5-2-3 Google Map

To display the location of the managed CPE with a bird's eye view, open Central VPN Management>>CPE Management and click the tab of Google Map.





## VII-5-3 VPN Management

An easy and quick method is offered to configure VPN settings for building VPN connection automatically between Vigor2927 series (treated as VPN server) and other Vigor router (treated as CPE device, i.e., VPN client).

Central Management >> VPN >> VPN Management

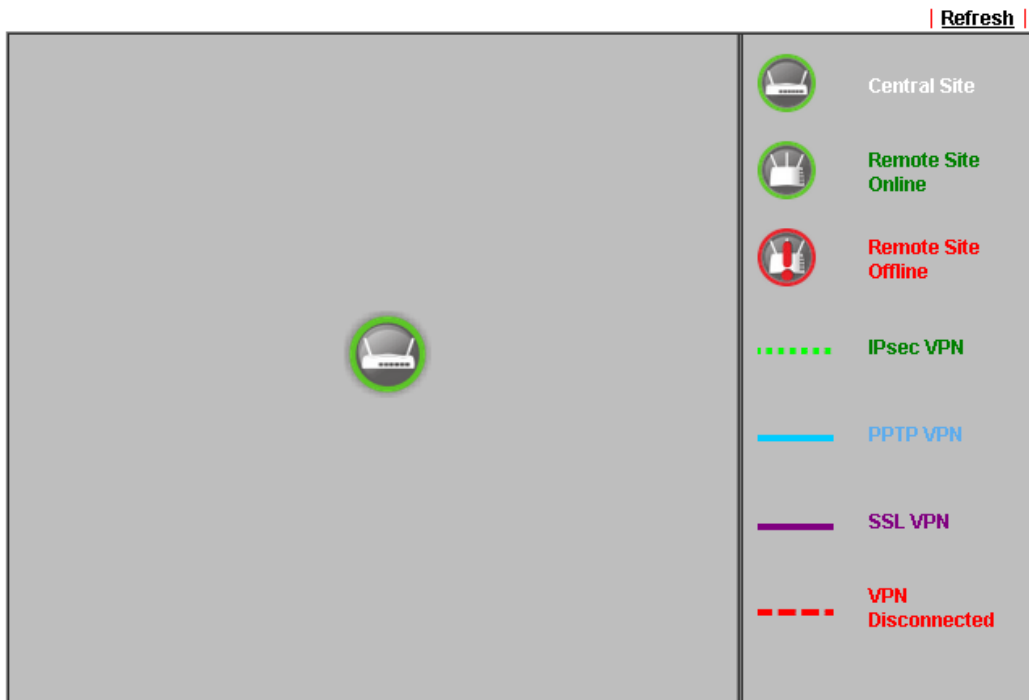

**Note:**

CVM SSL LAN-to-LAN dial-up might fail with the CPE of old version firmware. Please update the remote CPE to the latest version.

**CPE VPN Connection List**

| VPN | Type | Remote IP | Virtual Network | Tx Pkts | Tx Rate(Bps) | Rx Pkts | Rx Rate(Bps) | Up Time |
|-----|------|-----------|-----------------|---------|--------------|---------|--------------|---------|
|-----|------|-----------|-----------------|---------|--------------|---------|--------------|---------|

Available parameters are listed as follows:

| Item                           | Description                                                                                                                                                                              |
|--------------------------------|------------------------------------------------------------------------------------------------------------------------------------------------------------------------------------------|
| <b>CPE VPN Connection List</b> |                                                                                                                                                                                          |
| VPN                            | Display the name of the LAN-to-LAN profile.<br>It is generated automatically when you click the PPTP/IPsec/Advanced button to build the VPN connection between Vigor2927 and remote CPE. |
| Type                           | Display the dial-in type and the authentication method.                                                                                                                                  |
| Remote IP                      | Display the IP address of the remote CPE and the interface.                                                                                                                              |
| Virtual Network                | Display the IP address and subnet mask of Vigor2927 series.                                                                                                                              |
| Tx Pkts                        | Display the number of the transmitted packets.                                                                                                                                           |
| Tx Rate(Bps)                   | Display the number of the transmitted rate.                                                                                                                                              |
| Rx Pkts                        | Display the number of the received packets.                                                                                                                                              |
| Rx Rate(Bps)                   | Display the number of the received rate.                                                                                                                                                 |
| Up Time                        | Display the connection time of such VPN.                                                                                                                                                 |

Once the device is managed (controlled) by Vigor2927 series, it will be displayed on such screen automatically. If not, refer to sections “How to manage the CPE (router) through Vigor2927?” for more detailed information.

## VII-5-4 Log & Alert

This page offers brief information to identify the CPE connected to Vigor2927 series.

Central Management >> VPN >> Log & Alert

| Log                                                                   |                  | Alert                  |                 |                         |
|-----------------------------------------------------------------------|------------------|------------------------|-----------------|-------------------------|
| <a href="#">Refresh</a>   <a href="#">Clear</a>                       |                  |                        |                 |                         |
| Display Mode <input type="text" value="Always record the new event"/> |                  |                        |                 |                         |
| Device Name                                                           | Description Name | time & date            | Action Type     | Message                 |
| 001DAAB61BB8                                                          |                  | 2014-08-11<br>11:02:07 | CPE Maintenance | CPE Online              |
| 001DAAB61BB8                                                          |                  | 2000-01-01<br>00:00:00 | CPE Maintenance | Add CPE<br>Successfully |

Available settings are explained as follows:

| Item             | Description                                                                                                                                                                                                                                                                                                                            |
|------------------|----------------------------------------------------------------------------------------------------------------------------------------------------------------------------------------------------------------------------------------------------------------------------------------------------------------------------------------|
| Display Mode     | Choose the mode you want to display the related information on the following table. <ul style="list-style-type: none"> <li>● Stop record when fulls - when the capacity of CVM log is full, the system will stop recording.</li> <li>● Always record the new event - only the newest events will be recorded by the system.</li> </ul> |
| Device Name      | Display the name of the managed CPE.                                                                                                                                                                                                                                                                                                   |
| Description Name | Display the brief explanation for the managed CPE.                                                                                                                                                                                                                                                                                     |
| Time & date      | Display the time and date that the managed CPE scanned by Vigor2927 series.                                                                                                                                                                                                                                                            |
| Action Type      | Display the action that Vigor2927 series will perform for the managed CPE.                                                                                                                                                                                                                                                             |
| Message          | Display the information for each event.                                                                                                                                                                                                                                                                                                |

The Alert page offers brief information to identify the CPE connected to Vigor2927 series.

---

## Application Notes

### A-1 CVM Application - How to manage the CPE (router) through Vigor2927 series?

To manage CPEs through Vigor2927 series, you have to set URL on CPE first and set username and password for Vigor2927 series. For this section, we use Vigor2850 series as the example. All the CPE configuration will be done through Vigor2850 series.

#### Configure CVM Settings on Vigor2927 series

1. Access into the web user interface of Vigor2927 series.
2. Open Central Management >> VPN >> General Setup.

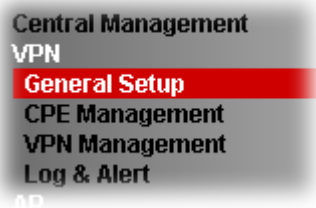

3. In the following page, check the boxes for CVM Port and CVM SSL Port to enable the port setting. Enter the values for CVM Port, CVM SSL Port, Username, and Password respectively. Remember the values configured in this page.

Central Management >> VPN >> General Setup

| General Settings                                 | IPsec VPN Settings                                                   |
|--------------------------------------------------|----------------------------------------------------------------------|
| <input checked="" type="checkbox"/> CVM SSL Port | <input type="text" value="8443"/>                                    |
| <input checked="" type="checkbox"/> CVM Port     | <input type="text" value="8000"/>                                    |
| CVM WAN interface                                | <input type="text" value="WAN1"/> / <input type="text" value="---"/> |
| Username                                         | <input type="text" value="acs"/>                                     |
| Password                                         | <input type="password" value="*****"/>                               |
| Polling Interval                                 | <input type="text" value="600"/> Seconds                             |

**Note:**

At least one port (CVM SSL Port or CVM Port) must be enabled for CVM to be operational. Use "CVM SSL port" for maximum security as all traffic will be encrypted.

OK

4. Click OK to save the settings.

## Configure Settings on CPE

1. In the end of the CPE, access into the web user interface of the CPE (e.g., Vigor2865 series). Open a web browser (for example, IE, Mozilla Firefox or Netscape) and type `http://192.168.1.1`.
2. Open System Maintenance >> TR-069.

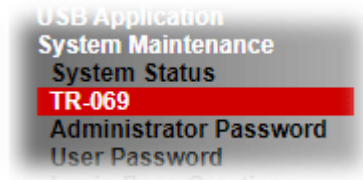

3. In the field of ACS Server, Enter the URL (IP address with port number) of Vigor2927 series and Enter the same Username and Password defined on the page of Central VPN Management>>General Setup in Vigor2927 series. Click OK to save the settings.

System Maintenance >> TR-069 Setting

A screenshot of the 'System Maintenance >> TR-069 Setting' page. The page has three tabs: 'ACS and CPE Settings', 'Reporting Configuration', and 'Export Parameters'. The 'ACS and CPE Settings' tab is active. Under 'TR-069', there are radio buttons for 'Disable' and 'Enable' (selected). Below that is 'ACS Server On' with a dropdown menu set to 'Internet'. The 'ACS Server' section is highlighted with a red box and contains: 'URL' with the text 'https://192.168.1.5:4433/ACSServer/services/ACSServlet' and a 'Wizard' button; a checkbox for 'Acquire URL from DHCP option 43' (unchecked); 'Username' with the text 'acs'; 'Password' with masked characters '\*\*\*\*\*'; a 'Test With Inform' button; and 'Event Code' with a dropdown menu set to 'PERIODIC'. Below this is 'Last Inform Response Time :(NA)' with a red dot. At the bottom, under 'CPE Client', there are radio buttons for 'HTTP' (selected) and 'HTTPS'.

4. Open System Maintenance>>Management Setup.

5. Check Allow management from the Internet to set management access control and click OK.

System Maintenance >> Management ?

| IPv4 Management Setup                                                                                                                                                                                                                                                                                                                                                                                                                                                                                                                                                          | IPv6 Management Setup | LAN Access Setup |               |           |           |   |  |  |
|--------------------------------------------------------------------------------------------------------------------------------------------------------------------------------------------------------------------------------------------------------------------------------------------------------------------------------------------------------------------------------------------------------------------------------------------------------------------------------------------------------------------------------------------------------------------------------|-----------------------|------------------|---------------|-----------|-----------|---|--|--|
| Router Name: DrayTek                                                                                                                                                                                                                                                                                                                                                                                                                                                                                                                                                           |                       |                  |               |           |           |   |  |  |
| <input type="checkbox"/> Default:Disable Auto-Logout<br><input type="checkbox"/> Enable Validation Code in Internet/LAN Access                                                                                                                                                                                                                                                                                                                                                                                                                                                 |                       |                  |               |           |           |   |  |  |
| <b>Internet Access Control</b><br><input checked="" type="checkbox"/> Allow management from the Internet<br>Domain name allowed: <input type="text"/>                                                                                                                                                                                                                                                                                                                                                                                                                          |                       |                  |               |           |           |   |  |  |
| <input type="checkbox"/> FTP Server<br><input checked="" type="checkbox"/> HTTP Server <input checked="" type="checkbox"/> Enforce HTTPS Access<br><input checked="" type="checkbox"/> HTTPS Server<br><input checked="" type="checkbox"/> Telnet Server<br><input type="checkbox"/> TR069 Server<br><input type="checkbox"/> SSH Server<br><input type="checkbox"/> SNMP Server<br><input checked="" type="checkbox"/> Disable PING from the Internet                                                                                                                         |                       |                  |               |           |           |   |  |  |
| <b>Access List from the Internet</b><br><input type="checkbox"/> Apply Access List to PING<br>List: <table border="1"> <thead> <tr> <th>index in List</th> <th>IP Object</th> <th>IP / Mask</th> </tr> </thead> <tbody> <tr> <td>1</td> <td></td> <td></td> </tr> </tbody> </table>                                                                                                                                                                                                                                                                                            |                       |                  | index in List | IP Object | IP / Mask | 1 |  |  |
| index in List                                                                                                                                                                                                                                                                                                                                                                                                                                                                                                                                                                  | IP Object             | IP / Mask        |               |           |           |   |  |  |
| 1                                                                                                                                                                                                                                                                                                                                                                                                                                                                                                                                                                              |                       |                  |               |           |           |   |  |  |
| <b>Management Port Setup</b><br><input checked="" type="radio"/> User Define Ports <input type="radio"/> Default Ports<br>Telnet Port: <input type="text" value="23"/> (Default: 23)<br>HTTP Port: <input type="text" value="80"/> (Default: 80)<br>HTTPS Port: <input type="text" value="443"/> (Default: 443)<br>FTP Port: <input type="text" value="21"/> (Default: 21)<br>TR069 Port: <input type="text" value="8069"/> (Default: 8069)<br>SSH Port: <input type="text" value="22"/> (Default: 22)<br><b>Note:</b><br>Ports 8001 and 8043 are used for Hotspot Web Portal. |                       |                  |               |           |           |   |  |  |
| <b>Brute Force Protection</b><br><input type="checkbox"/> Enable brute force login protection<br><input type="checkbox"/> FTP Server<br><input type="checkbox"/> HTTP Server<br><input type="checkbox"/> HTTPS Server<br><input type="checkbox"/> Telnet Server<br><input type="checkbox"/> TR069 Server<br><input type="checkbox"/> SSH Server                                                                                                                                                                                                                                |                       |                  |               |           |           |   |  |  |

6. Open WAN>>Internet Access. Use the drop down list of Access Mode on WAN1 to select MPoA (RFC1483/2684). Then, click Details Page.
7. Click Specify an IP address. Type correct WAN IP address, subnet mask and gateway IP address for your CPE. Then click OK.

WAN >> Internet Access

WAN 1

| PPPoE                                                                                                                                                                               | Static or Dynamic IP | PPTP/L2TP                                                                                                                                                                                                                                                                                                                                                                        | IPv6 |
|-------------------------------------------------------------------------------------------------------------------------------------------------------------------------------------|----------------------|----------------------------------------------------------------------------------------------------------------------------------------------------------------------------------------------------------------------------------------------------------------------------------------------------------------------------------------------------------------------------------|------|
| <input checked="" type="radio"/> Enable <input type="radio"/> Disable                                                                                                               |                      |                                                                                                                                                                                                                                                                                                                                                                                  |      |
| <b>Keep WAN Connection</b><br><input type="checkbox"/> Enable PING to keep alive<br>PING to the IP: <input type="text"/><br>PING Interval: <input type="text" value="0"/> minute(s) |                      | <b>WAN IP Network Settings</b> <input type="text" value="WAN IP Alias"/><br><input type="radio"/> Obtain an IP address automatically<br>Router Name: <input type="text" value="Vigor"/><br>Domain Name: <input type="text" value="Max: 39 characters"/><br><input type="checkbox"/> DHCP Client Identifier *<br>Username: <input type="text"/><br>Password: <input type="text"/> |      |
| <b>WAN Connection Detection</b><br>Mode: <input type="text" value="ARP Detect"/>                                                                                                    |                      | <input checked="" type="radio"/> Specify an IP address<br>IP Address: <input type="text" value="192.168.30.12"/><br>Subnet Mask: <input type="text" value="255.255.0.0"/><br>Gateway IP Address: <input type="text" value="172.16.3.4"/>                                                                                                                                         |      |
| <b>MTU</b><br><input type="text" value="1500"/> (Max: 1500)<br>Path MTU Discovery: <input type="text" value="Detect"/>                                                              |                      | <input checked="" type="radio"/> Default MAC Address<br><input type="radio"/> Specify a MAC Address<br>MAC Address: <input type="text" value="14"/> · <input type="text" value="49"/> · <input type="text" value="BC"/> : <input type="text" value="02"/> · <input type="text" value="37"/> · <input type="text" value="E9"/>                                                    |      |
| <b>RIP Protocol</b><br><input type="checkbox"/> Enable RIP                                                                                                                          |                      | <b>DNS Server IP Address</b><br>Primary IP Address: <input type="text" value="8.8.8.8"/><br>Secondary IP Address: <input type="text" value="8.8.4.4"/>                                                                                                                                                                                                                           |      |
| <b>Bridge Mode</b><br><input type="checkbox"/> Enable Bridge Mode<br><input type="checkbox"/> Enable Full Bridge Mode<br>Bridge Subnet: <input type="text" value="LAN 1"/>          |                      |                                                                                                                                                                                                                                                                                                                                                                                  |      |
| <b>TTL</b><br>Change the TTL value: <input type="text" value="Enable"/>                                                                                                             |                      |                                                                                                                                                                                                                                                                                                                                                                                  |      |

\*: Required for some ISPs

**Note:**

1. If enable firewall in bridge mode, IPv6 connection type would be change to DHCPv6 mode.
2. Bridge Subnet cannot be selected by Multi-WAN Interface at the same time.
3. If both Bridge Mode and Firewall are enabled, the settings under User Management will be ignored.
4. Full Bridge Mode supports forwarding packets with VLAN tags.
5. Full Bridge Mode doesn't support wireless LAN.

OK Cancel



## Info

Reboot the CPE device and re-log into Vigor2927 series. CPE which has registered to Vigor2927 series will be captured and displayed on the page of Central VPN Management>>CPE Management.

## Check CPE Maintenance Page

1. Return to the web user interface of Vigor2927 series.
2. Open Central Management>>VPN>>VPN Management. Now there is one CPE displayed on the field of Unmanaged Devices List.
3. Choose the one (Vigor2927) from Unmanaged Devices List and click Add. The following dialog will be popped up. Enter the name and the location of the router respectively. Click OK to save the configuration.

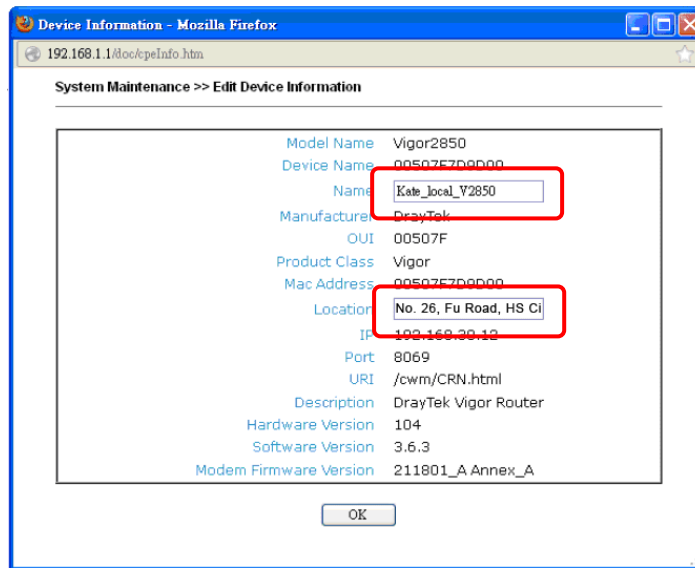

4. The selected CPE will be moved and displayed on Managed Devices List which means it is controlled / managed by Vigor2927 series from now on.

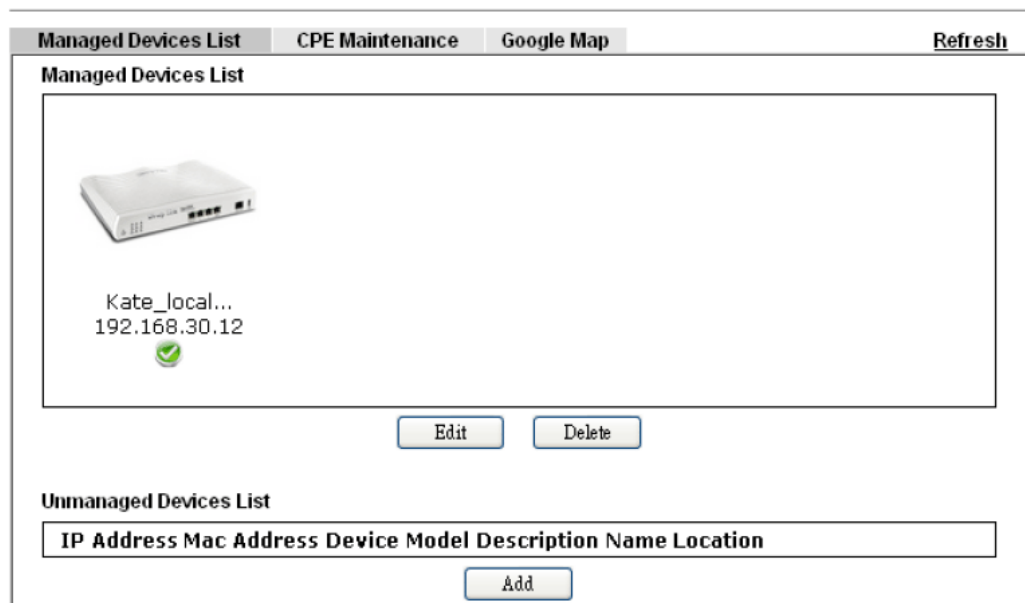

## A-2 CVM Application - How to upgrade CPE firmware through Vigor2927 series?

Download the newest firmware from your Draytek website to USB Storage Disk for the device (e.g., Vigor2865) managed by Vigor2927 series.

Vigor2865, as an example, is chosen for Vigor2927 to perform the CPE firmware upgrade remotely in this case.

1. Plug in USB storage disk onto Vigor2927 series via USB interface. Make sure the USB disk has been installed correctly, otherwise, the firmware upgrade will not be successful.
2. Access into web user interface of Vigor2927 series. Open Central VPN Management>>CPE Management and click the CPE Maintenance tab.

Central Management >> VPN >> CPE Management >> CPE Maintenance

The screenshot shows the 'CPE Maintenance' tab in the web interface. At the top, there are navigation tabs: 'Managed Devices List', 'CPE Maintenance', and 'Google Map'. A 'Refresh' button is in the top right. Below the tabs, the 'USB Status' is 'Disconnected' with a red USB icon, and 'Disk Usage' is '---'. There is a 'File Explorer' icon. A link 'Set to Factory Default' is visible. The main content is a table with the following columns: Index, Enable, Profile Name, Device Name, Action, Schedule, and a 'Now' button. The table contains 8 rows, all with '0,0' in the Schedule column. Below the table are navigation links: '<< 1-8 | 9-16 >>'. At the bottom of the screenshot are 'OK' and 'Cancel' buttons.

| Index              | Enable                   | Profile Name | Device Name | Action | Schedule |     |
|--------------------|--------------------------|--------------|-------------|--------|----------|-----|
| <a href="#">1.</a> | <input type="checkbox"/> |              |             |        | 0,0      | Now |
| <a href="#">2.</a> | <input type="checkbox"/> |              |             |        | 0,0      | Now |
| <a href="#">3.</a> | <input type="checkbox"/> |              |             |        | 0,0      | Now |
| <a href="#">4.</a> | <input type="checkbox"/> |              |             |        | 0,0      | Now |
| <a href="#">5.</a> | <input type="checkbox"/> |              |             |        | 0,0      | Now |
| <a href="#">6.</a> | <input type="checkbox"/> |              |             |        | 0,0      | Now |
| <a href="#">7.</a> | <input type="checkbox"/> |              |             |        | 0,0      | Now |
| <a href="#">8.</a> | <input type="checkbox"/> |              |             |        | 0,0      | Now |

**Note:**

1. USB storage must be connected before profiles can be enabled.
2. Click the "Now" button to execute the profile immediately.

OK Cancel

3. Click any index number link, e.g., Index 1.

Central Management >> VPN >> CPE Management >> CPE Maintenance

This is a partial screenshot of the same web interface. It shows the 'CPE Maintenance' tab, the 'USB Status: Disconnected' indicator, and the top part of the table with columns 'Index', 'Enable', 'Profile Name', and 'Device Name'. The 'Index' column shows links for 1, 2, 3, and 4. Below the table, the navigation links '<< 1-8 | 9-16 >>' are visible.

- The Maintenance profile dialog appears.

Central VPN Management >> CPE Management >> Maintenance Profile

**Note:**

- Enable "Only Run Once" to automatically disable the profile after it has been run.
- The Action setting in the schedule profile will be ignored.

OK Clear Cancel

In the field of Profile Name, type a name for such maintenance profile; check Enable; and choose the one you want to perform firmware upgrade from Device Name drop down list. From the Action Type, choose Firmware Upgrade. Enter the file/path of the newest firmware or click Select to locate it. Specify the Schedule profile. At last, click OK.

- Now, a new maintenance profile has been created.

Central Management >> VPN >> CPE Management >> CPE Maintenance

| Index | Enable                              | Profile Name | Device Name  | Action           | Schedule              |
|-------|-------------------------------------|--------------|--------------|------------------|-----------------------|
| 1.    | <input checked="" type="checkbox"/> | 2927         | 00507F7D9D00 | Firmware Upgrade | 0, 0 <span>Now</span> |
| 2.    | <input type="checkbox"/>            |              |              |                  | 0, 0 <span>Now</span> |
| 3.    | <input type="checkbox"/>            |              |              |                  | 0, 0 <span>Now</span> |
| 4.    | <input type="checkbox"/>            |              |              |                  | 0, 0 <span>Now</span> |
| 5.    | <input type="checkbox"/>            |              |              |                  | 0, 0 <span>Now</span> |
| 6.    | <input type="checkbox"/>            |              |              |                  | 0, 0 <span>Now</span> |
| 7.    | <input type="checkbox"/>            |              |              |                  | 0, 0 <span>Now</span> |
| 8.    | <input type="checkbox"/>            |              |              |                  | 0, 0 <span>Now</span> |

**Note:**

- USB storage must be connected before profiles can be enabled.
- Click the "Now" button to execute the profile immediately.

OK Cancel

- Click Now to perform the firmware upgrade immediately for Vigor2927.
- Wait for several minutes for firmware upgrade.



8. Then check the device information for the managed device if the firmware upgrade is successful or not. Click Managed Devices List.

Managed Devices List    CPE Maintenance    Google Map    Refresh

**Managed Devices List**



Kate\_local...  
192.168.30.12  

**Unmanaged Devices List**

| IP Address | Mac Address | Device Model | Description | Name | Location |
|------------|-------------|--------------|-------------|------|----------|
|------------|-------------|--------------|-------------|------|----------|

Click the icon of Vigor2865 and click Edit and view the software version. Another way to check if the firmware upgrade is completed or not, simply open Central VPN Management>>Log & Alert.

---

## VII-6 Central Management (AP)

Vigor2927 can manage the access points supporting AP management via Central AP Management.

### AP Map

AP Map is helpful to determine the best location for VigorAP in a room. A floor plan of a room is required to be uploaded first. By dragging and dropping available VigorAP icon from the list to the floor plan, the placement with the best wireless coverage will be clearly indicated through simulated signal strength

### AP Maintenance

Vigor router can execute configuration backup, configuration restoration, firmware upgrade and remote reboot for the APs managed by the router. It is very convenient for the administrator to process maintenance without accessing into the web user interface of the access point.

### Load Balance for AP

The parameters configured for Load Balance can help to distribute the traffic for all of the access points registered to Vigor router. Thus, the bandwidth will not be occupied by certain access points.

#### AP Load Balance (Traffic overload)

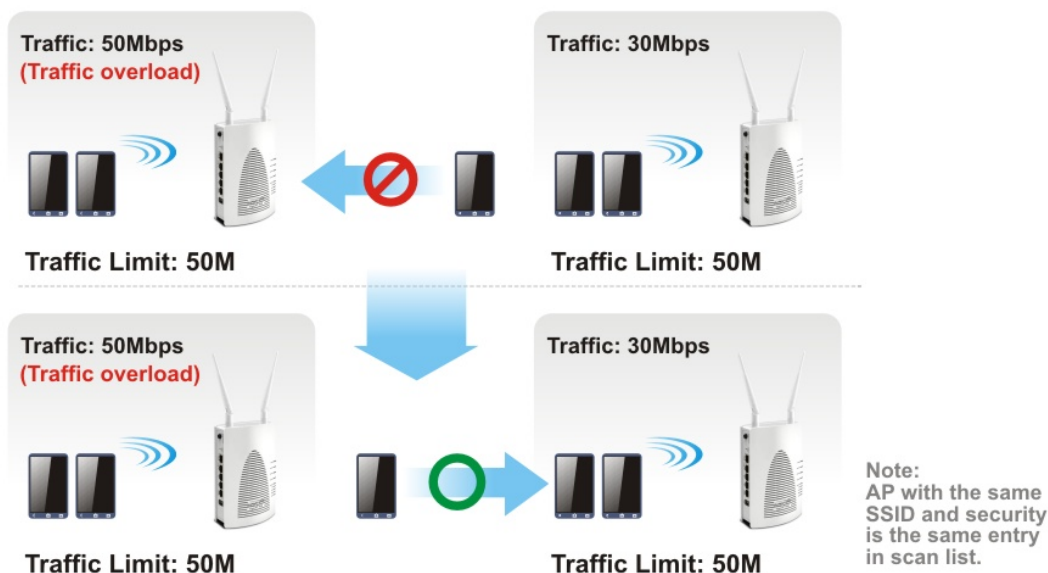

# Web User Interface

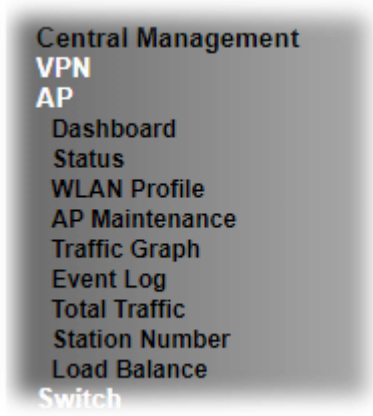

## VII-6-1 Dashboard

This page shows VigorAP's information about Status, Event Log, Total Traffic or Station Number by displaying VigorAP icon, text and histogram. Just move and click your mouse cursor on Status, Event Log, Total Traffic or Station Number. Corresponding web pages will be open immediately.

Central Management >> AP >> Dashboard

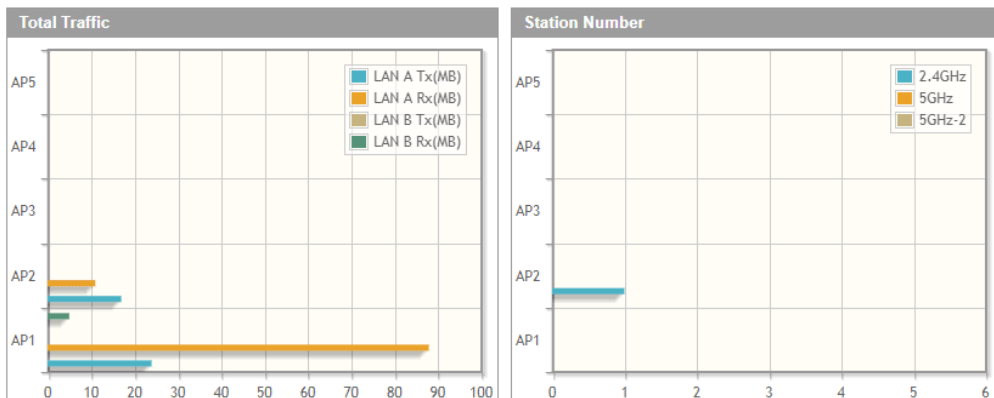
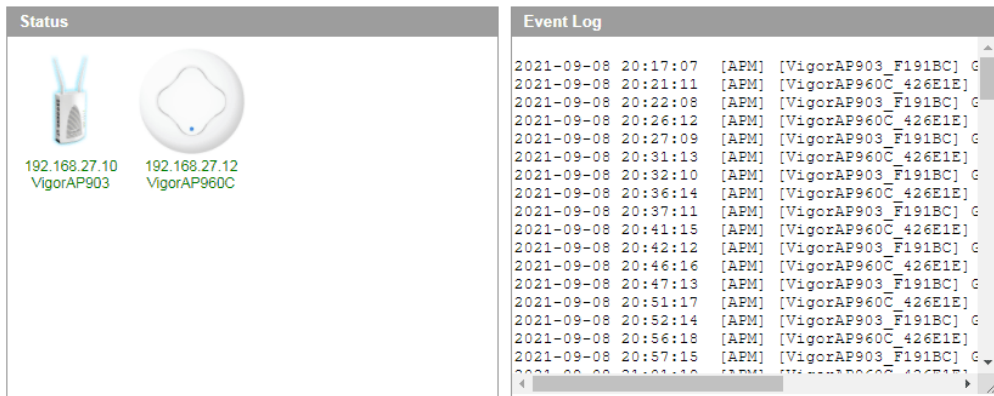

AP1-- IP:192.168.27.10 Device Name:VigorAP903  
 AP2-- IP:192.168.27.12 Device Name:VigorAP960C

AP1-- IP:192.168.27.10 Device Name:VigorAP903  
 AP2-- IP:192.168.27.12 Device Name:VigorAP960C

**Note:**  
 Only browser supporting [HTML5](#) can display dashboard correctly.









To access into the web user interface of VigorAP, simply move your mouse cursor on the VigorAP icon and click it. The system will guide you to access into the web user interface of VigorAP.

## VII-6-2 Status

This page displays current status (online, offline or SSID hidden, IP address, encryption, channel, version, password and etc.) of the access points managed by Vigor router. Please open Central AP Management>>Function Support List to check what AP Models are supported.

Central Management >> AP >> Status

| [Clear](#) | [Refresh](#) |

| Index                                                                             | Device Name | IP Address    | SSID                                                                                                                                                                                      | Ch.      | STA List    | Uptime   | Ver.  | Password                              | Information                                                                                                 |
|-----------------------------------------------------------------------------------|-------------|---------------|-------------------------------------------------------------------------------------------------------------------------------------------------------------------------------------------|----------|-------------|----------|-------|---------------------------------------|-------------------------------------------------------------------------------------------------------------|
|  | VigorAP903  | 192.168.27.10 |  mk903<br> marketing903 | 11<br>36 | 0/3<br>0/30 | 2d 01:16 | 1.4.2 | <input type="text" value="Password"/> |  <a href="#">Details</a> |
|  | VigorAP960C | 192.168.27.12 |  marketing<br> mk960    | 11<br>36 | 0/3<br>0/30 | 1d 16:58 | 1.4.2 | <input type="text" value="Password"/> |  <a href="#">Details</a> |

Note:

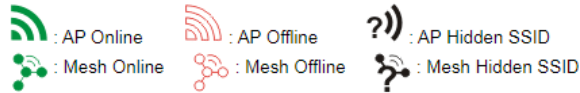

Maximum support 20 APs.

1. Display the overall mesh network information instead of the each AP in the mesh network.
2. The status of local mesh network is listed on [Mesh >> Mesh Status](#) page.
3. When AP Devices connect via an intermediary switch, please ensure that UDP:4944 port and the HTTP port of AP Devices are not blocked so that the AP status can be retrieved.

Available settings are explained as follows:

| Item        | Description                                                                                                                                                                                                                                                                                                                             |
|-------------|-----------------------------------------------------------------------------------------------------------------------------------------------------------------------------------------------------------------------------------------------------------------------------------------------------------------------------------------|
| Index       | Click the index number link for viewing the settings summary of the access point.                                                                                                                                                                                                                                                       |
| Device Name | The name of the AP managed by Vigor router will be displayed here.                                                                                                                                                                                                                                                                      |
| IP Address  | Display the true IP address of the access point.                                                                                                                                                                                                                                                                                        |
| SSID        | Display the SSID configured for the access point(s) connected to Vigor2927.                                                                                                                                                                                                                                                             |
| Ch.         | Display the channel used by the access point.                                                                                                                                                                                                                                                                                           |
| STA List    | Display the number of wireless clients (stations) connecting to the access point.<br>In which, 0/64 means that up to 64 clients are allowed to connect to the access point. But, now no one connects to the access point.<br>The number displayed on the left side means 2.4GHz; and the number displayed on the right side means 5GHz. |
| Uptime      | Display the duration of the AP powered up.                                                                                                                                                                                                                                                                                              |
| Version     | Display the firmware version used by the access point.                                                                                                                                                                                                                                                                                  |
| Password    | Vigor2927 can get related information of the access point by accessing into the web user interface of the access point.<br>This button is used to modify the logging password of the connected access point.                                                                                                                            |
| Details     | Click to open a window of detailed information related to the selected VigorAP.                                                                                                                                                                                                                                                         |

## VII-6-3 WLAN Profile

WLAN profile is used to apply to a selected access point. It is very convenient for the administrator to configure the setting for access point without opening the web user interface of the access point.

Central Management >> AP >> WLAN Profile

| Profile           | Name    | Main SSID     | Security     | Multi-SSID | WLAN ACL | Rate Ctrl | Clone | To AP | To Local |
|-------------------|---------|---------------|--------------|------------|----------|-----------|-------|-------|----------|
| <a href="#">1</a> | Default | DrayTek-LAN-A | WPA+WPA2/PSK | Enable     | None     | None      |       |       |          |
| <a href="#">2</a> | ---     | ---           | ---          | ---        | ---      | ---       | ---   | ---   | ---      |
| <a href="#">3</a> | ---     | ---           | ---          | ---        | ---      | ---       | ---   | ---   | ---      |
| <a href="#">4</a> | ---     | ---           | ---          | ---        | ---      | ---       | ---   | ---   | ---      |
| <a href="#">5</a> | ---     | ---           | ---          | ---        | ---      | ---       | ---   | ---   | ---      |

Click the number link of the selected profile to modify the content of the profile. Available settings are explained as follows:

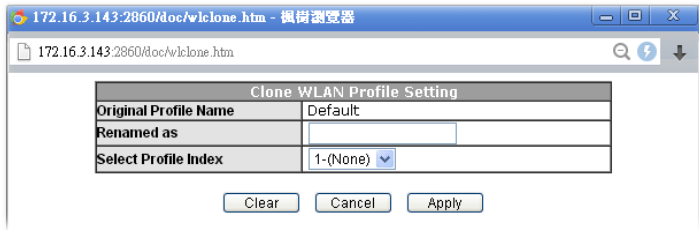
| Item       | Description                                                                                                                                                                                                                                                                                                                                                                                                                                                                                                                                                                                                            |
|------------|------------------------------------------------------------------------------------------------------------------------------------------------------------------------------------------------------------------------------------------------------------------------------------------------------------------------------------------------------------------------------------------------------------------------------------------------------------------------------------------------------------------------------------------------------------------------------------------------------------------------|
| Profile    | There are five WLAN profiles offered to be configured. Simply click the index number link to open the modification page.                                                                                                                                                                                                                                                                                                                                                                                                                                                                                               |
| Name       | Display the name of the profile.<br>The default profile cannot be renamed.                                                                                                                                                                                                                                                                                                                                                                                                                                                                                                                                             |
| Main SSID  | Display the SSID configured by such wireless profile.                                                                                                                                                                                                                                                                                                                                                                                                                                                                                                                                                                  |
| Security   | Display the security mode selected by such wireless profile.                                                                                                                                                                                                                                                                                                                                                                                                                                                                                                                                                           |
| Multi-SSID | Enable means multiple SSIDs (more than one) are active.<br>Disable means only SSID1 is active.                                                                                                                                                                                                                                                                                                                                                                                                                                                                                                                         |
| WLAN ACL   | Display the name of the access control list.                                                                                                                                                                                                                                                                                                                                                                                                                                                                                                                                                                           |
| Rate Ctrl  | Display the upload and/or download transmission rate.                                                                                                                                                                                                                                                                                                                                                                                                                                                                                                                                                                  |
| Clone      | <p>It can copy settings from an existing WLAN profile to another WLAN profile.</p> <p>First, you have to check the box of the existing profile as the original profile. Second, click Clone. The following dialog will appear.</p>  <p>Third, choose the profile index to accept the settings from the original profile. Forth, type a new name in the field of Renamed as. Last, click Apply to save the settings on this dialog.</p> <p>The new profile has been created with the settings coming from the original profile.</p> |
| To AP      | Click it to apply the selected wireless profile to the specified Access Point.                                                                                                                                                                                                                                                                                                                                                                                                                                                                                                                                         |

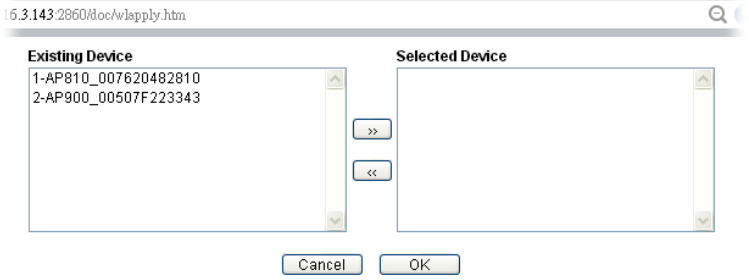
|          |                                                                                                                                                                                                                                                                                                                                                                    |
|----------|--------------------------------------------------------------------------------------------------------------------------------------------------------------------------------------------------------------------------------------------------------------------------------------------------------------------------------------------------------------------|
|          |  <p>Simply choose the device you want from Existing Device field. Click &gt;&gt; to move the device to Selected Device field. Then, click OK.</p> <p>The selected WLAN profile will be applied to the selected access point immediately. Later the access point will reboot.</p> |
| To Local | <p>WLAN Profile configured in this page is specified for VigorAP connected to Vigor router.</p> <p>If required, these settings also can be applied to Vigor router. Select and check one of wireless profiles and click this button to apply the settings onto the WI-Fi wireless settings configured for such Vigor router.</p>                                   |

## How to edit the wireless LAN profile?

1. Select the WLAN profile (index number 1 to 5) you want to edit.
2. Click the index number link to display the following page.

Central Management >> AP >> WLAN Profile

### WLAN Profile Edit

| Device Settings |                                                                                                                                                                        |
|-----------------|------------------------------------------------------------------------------------------------------------------------------------------------------------------------|
| Profile Name    | Default <input type="checkbox"/> Auto Provision                                                                                                                        |
| Administrator   | admin                                                                                                                                                                  |
| Password        | .....                                                                                                                                                                  |
| 2nd Subnet      | <input checked="" type="radio"/> Enable <input type="radio"/> Disable                                                                                                  |
| Management VLAN | <input type="checkbox"/> Enable Management VLAN:<br>LAN-A VLAN ID <input type="text" value="0"/> (0 ~ 4095)<br>LAN-B VLAN ID <input type="text" value="0"/> (0 ~ 4095) |

### WLAN General Setting

|                  | 2.4GHz                                                                                                                                                                                                                                                                                                                                                                                                          | 5GHz | 5GHz-2 |
|------------------|-----------------------------------------------------------------------------------------------------------------------------------------------------------------------------------------------------------------------------------------------------------------------------------------------------------------------------------------------------------------------------------------------------------------|------|--------|
| Wireless LAN     | <input type="radio"/> Enable <input checked="" type="radio"/> Disable                                                                                                                                                                                                                                                                                                                                           |      |        |
| Limit Client     | <input type="checkbox"/> Enable <input type="text" value="64"/> (3 ~ 128, default: 64)                                                                                                                                                                                                                                                                                                                          |      |        |
| Operation Mode   | AP                                                                                                                                                                                                                                                                                                                                                                                                              |      |        |
| 2.4G Mode        | Mixed(11b+11g+11n)                                                                                                                                                                                                                                                                                                                                                                                              |      |        |
| 2.4G Channel     | 2462MHz (Channel 11)                                                                                                                                                                                                                                                                                                                                                                                            |      |        |
| Airtime Fairness | <input type="checkbox"/> Enable Airtime Fairness:<br>Triggering Client Number <input type="text" value="2"/> (2 ~ 128, default: 2)                                                                                                                                                                                                                                                                              |      |        |
| Band Steering    | <input type="checkbox"/> Enable Band Steering:<br>Check Time for WLAN Client 5G Cap. <input type="text" value="15"/> seconds (1 ~ 60, default: 15)                                                                                                                                                                                                                                                              |      |        |
| Roaming          | <input type="checkbox"/> Minimum Basic Rate <input type="text" value="1"/> Mbps                                                                                                                                                                                                                                                                                                                                 |      |        |
|                  | <input checked="" type="radio"/> Disable RSSI Requirement<br><input type="radio"/> Strictly Minimum RSSI - <input type="text" value="73"/> dbm ( <input type="text" value="42"/> %) (default: -73)<br><input type="radio"/> Minimum RSSI - <input type="text" value="66"/> dbm ( <input type="text" value="60"/> %) (default: -66)<br>with Adjacent AP RSSI over <input type="text" value="5"/> dB (default: 5) |      |        |
|                  | <input type="checkbox"/> Enable Fast Roaming(WPA2/802.1x):<br>PMK Cache Period <input type="text" value="10"/> minutes (10 ~ 600, default: 10)                                                                                                                                                                                                                                                                  |      |        |
| WMM              | <input type="radio"/> Enable <input checked="" type="radio"/> Disable                                                                                                                                                                                                                                                                                                                                           |      |        |
| Tx Power         | 100%                                                                                                                                                                                                                                                                                                                                                                                                            |      |        |
| Channel Width    | Auto 20/40 MHz                                                                                                                                                                                                                                                                                                                                                                                                  |      |        |



Info

The function of Auto Provision is available for the default WLAN profile.

- After finished the general settings configuration, click Next to open the following page for 2.4GHz wireless security settings.

Central Management >> AP >> WLAN Profile

| SSID1                    | SSID2                                                                                                                                                                                                                                                                                                                | SSID3             | SSID4                                                                                 |
|--------------------------|----------------------------------------------------------------------------------------------------------------------------------------------------------------------------------------------------------------------------------------------------------------------------------------------------------------------|-------------------|---------------------------------------------------------------------------------------|
| <b>2.4GHz SSID</b>       |                                                                                                                                                                                                                                                                                                                      |                   |                                                                                       |
| Active                   | <input checked="" type="radio"/> Enable <input type="radio"/> Disable                                                                                                                                                                                                                                                |                   |                                                                                       |
| SSID                     | DrayTek-LAN-A                                                                                                                                                                                                                                                                                                        | LAN-A ▾           | <input type="checkbox"/> Hide SSID                                                    |
| VLAN                     | 0 (0:untag)                                                                                                                                                                                                                                                                                                          |                   |                                                                                       |
| Isolate                  | <input type="checkbox"/> From Member                                                                                                                                                                                                                                                                                 |                   |                                                                                       |
| <b>Security Settings</b> |                                                                                                                                                                                                                                                                                                                      |                   |                                                                                       |
| Encryption               | WPA+WPA2/PSK ▾                                                                                                                                                                                                                                                                                                       |                   |                                                                                       |
|                          | Set up <b>RADIUS Server</b> if 802.1X is enabled.                                                                                                                                                                                                                                                                    |                   |                                                                                       |
|                          | <b>WPA</b><br>WPA Algorithms <input type="radio"/> TKIP <input type="radio"/> AES <input checked="" type="radio"/> TKIP/AES<br>Pass Phrase <input type="password" value="*****"/><br>Key Renewal Interval <input type="text" value="3600"/> Seconds                                                                  |                   |                                                                                       |
|                          | <b>WEP</b><br>Setup <b>WEP Key</b> if WEP is enabled.<br>802.1X WEP <input type="radio"/> Enable <input checked="" type="radio"/> Disable                                                                                                                                                                            |                   |                                                                                       |
| <b>Access Control</b>    |                                                                                                                                                                                                                                                                                                                      |                   |                                                                                       |
| Mode                     | None ▾                                                                                                                                                                                                                                                                                                               |                   |                                                                                       |
| List                     |                                                                                                                                                                                                                                                                                                                      |                   |                                                                                       |
|                          | Client's MAC Address : <input type="text"/> : <input type="text"/> : <input type="text"/> : <input type="text"/> : <input type="text"/> : <input type="text"/><br><input type="button" value="Add"/> <input type="button" value="Delete"/> <input type="button" value="Edit"/> <input type="button" value="Cancel"/> |                   |                                                                                       |
| <b>Bandwidth Limit</b>   |                                                                                                                                                                                                                                                                                                                      |                   |                                                                                       |
| Status                   | <input type="radio"/> Enable <input checked="" type="radio"/> Disable                                                                                                                                                                                                                                                |                   | Auto Adjustment <input type="radio"/> Enable <input checked="" type="radio"/> Disable |
| Upload                   | <input type="text" value="0"/> Kbps                                                                                                                                                                                                                                                                                  | Download          | <input type="text" value="0"/> Kbps                                                   |
| <b>Station Control</b>   |                                                                                                                                                                                                                                                                                                                      |                   |                                                                                       |
| Status                   | <input type="radio"/> Enable <input checked="" type="radio"/> Disable                                                                                                                                                                                                                                                |                   |                                                                                       |
| Connection Time          | <input type="text" value="1 hour"/> ▾                                                                                                                                                                                                                                                                                | Reconnection Time | <input type="text" value="1 hour"/> ▾                                                 |



4. After finished the above web page configuration, click Next to open the following page for 5GHz wireless security settings.

Central Management >> AP >> WLAN Profile

| 5G SSID1                                                                         | 5G SSID2                                                                                                                                           | 5G SSID3                                                                                       | 5G SSID4                                                                              |
|----------------------------------------------------------------------------------|----------------------------------------------------------------------------------------------------------------------------------------------------|------------------------------------------------------------------------------------------------|---------------------------------------------------------------------------------------|
| <b>5GHz SSID</b>                                                                 |                                                                                                                                                    |                                                                                                |                                                                                       |
| Active                                                                           | <input type="radio"/> Enable <input type="radio"/> Disable                                                                                         |                                                                                                |                                                                                       |
| SSID                                                                             | DrayTek-5G                                                                                                                                         | LAN-A ▾                                                                                        | <input type="checkbox"/> Hide SSID                                                    |
| VLAN                                                                             | 0 (0:untag)                                                                                                                                        |                                                                                                |                                                                                       |
| Isolate                                                                          | <input type="checkbox"/> From Member                                                                                                               |                                                                                                |                                                                                       |
| <b>Security Settings</b>                                                         |                                                                                                                                                    |                                                                                                |                                                                                       |
| Encryption                                                                       | Disable ▾                                                                                                                                          |                                                                                                |                                                                                       |
|                                                                                  | Set up <b>RADIUS Server</b> if 802.1X is enabled.                                                                                                  |                                                                                                |                                                                                       |
|                                                                                  | <b>WPA</b>                                                                                                                                         |                                                                                                |                                                                                       |
|                                                                                  | WPA Algorithms                                                                                                                                     | <input type="radio"/> TKIP <input type="radio"/> AES <input checked="" type="radio"/> TKIP/AES |                                                                                       |
| Pass Phrase                                                                      | Max: 64 characters                                                                                                                                 |                                                                                                |                                                                                       |
| Key Renewal Interval                                                             | 3600 Seconds                                                                                                                                       |                                                                                                |                                                                                       |
| <b>WEP</b>                                                                       |                                                                                                                                                    |                                                                                                |                                                                                       |
| Setup <b>WEP Key</b> if WEP is enabled.                                          |                                                                                                                                                    |                                                                                                |                                                                                       |
| 802.1X WEP <input type="radio"/> Enable <input checked="" type="radio"/> Disable |                                                                                                                                                    |                                                                                                |                                                                                       |
| <b>Access Control</b>                                                            |                                                                                                                                                    |                                                                                                |                                                                                       |
| Mode                                                                             | None ▾                                                                                                                                             |                                                                                                |                                                                                       |
| List                                                                             |                                                                                                                                                    |                                                                                                |                                                                                       |
|                                                                                  | Client's MAC Address : <input type="text"/> : <input type="text"/> : <input type="text"/> : <input type="text"/> : <input type="text"/>            |                                                                                                |                                                                                       |
|                                                                                  | <input type="button" value="Add"/> <input type="button" value="Delete"/> <input type="button" value="Edit"/> <input type="button" value="Cancel"/> |                                                                                                |                                                                                       |
| <b>Bandwidth Limit</b>                                                           |                                                                                                                                                    |                                                                                                |                                                                                       |
| Status                                                                           | <input type="radio"/> Enable <input checked="" type="radio"/> Disable                                                                              |                                                                                                | Auto Adjustment <input type="radio"/> Enable <input checked="" type="radio"/> Disable |
| Upload                                                                           | 0 Kbps                                                                                                                                             | Download                                                                                       | 0 Kbps                                                                                |
| <b>Station Control</b>                                                           |                                                                                                                                                    |                                                                                                |                                                                                       |
| Status                                                                           | <input type="radio"/> Enable <input checked="" type="radio"/> Disable                                                                              |                                                                                                |                                                                                       |
| Connection Time                                                                  | 1 hour ▾                                                                                                                                           | Reconnection Time                                                                              | 1 hour ▾                                                                              |

and 5GHz-2 wireless security settings

Central Management >> AP >> WLAN Profile

| 5G-2 SSID1                                                                       | 5G-2 SSID2                                                                                                                                                     | 5G-2 SSID3                                                                                     | 5G-2 SSID4                                                                            |
|----------------------------------------------------------------------------------|----------------------------------------------------------------------------------------------------------------------------------------------------------------|------------------------------------------------------------------------------------------------|---------------------------------------------------------------------------------------|
| <b>5GHz-2 SSID</b>                                                               |                                                                                                                                                                |                                                                                                |                                                                                       |
| Active                                                                           | <input checked="" type="radio"/> Enable <input type="radio"/> Disable                                                                                          |                                                                                                |                                                                                       |
| SSID                                                                             | DrayTek-5G-2                                                                                                                                                   | LAN-A ▼                                                                                        | <input type="checkbox"/> Hide SSID                                                    |
| VLAN                                                                             | 0 (0:untag)                                                                                                                                                    |                                                                                                |                                                                                       |
| Isolate                                                                          | <input type="checkbox"/> From LAN <input type="checkbox"/> From Member                                                                                         |                                                                                                |                                                                                       |
| <b>Security Settings</b>                                                         |                                                                                                                                                                |                                                                                                |                                                                                       |
| Encryption                                                                       | Disable ▼                                                                                                                                                      |                                                                                                |                                                                                       |
|                                                                                  | Set up <b>RADIUS Server</b> if 802.1X is enabled.                                                                                                              |                                                                                                |                                                                                       |
|                                                                                  | <b>WPA</b>                                                                                                                                                     |                                                                                                |                                                                                       |
|                                                                                  | WPA Algorithms                                                                                                                                                 | <input type="radio"/> TKIP <input type="radio"/> AES <input checked="" type="radio"/> TKIP/AES |                                                                                       |
|                                                                                  | Pass Phrase                                                                                                                                                    | Max: 64 characters                                                                             |                                                                                       |
| Key Renewal Interval                                                             | 3600                                                                                                                                                           | Seconds                                                                                        |                                                                                       |
| <b>WEP</b>                                                                       |                                                                                                                                                                |                                                                                                |                                                                                       |
| Setup <b>WEP Key</b> if WEP is enabled.                                          |                                                                                                                                                                |                                                                                                |                                                                                       |
| 802.1X WEP <input type="radio"/> Enable <input checked="" type="radio"/> Disable |                                                                                                                                                                |                                                                                                |                                                                                       |
| <b>Access Control</b>                                                            |                                                                                                                                                                |                                                                                                |                                                                                       |
| Mode                                                                             | None ▼                                                                                                                                                         |                                                                                                |                                                                                       |
| List                                                                             |                                                                                                                                                                |                                                                                                |                                                                                       |
|                                                                                  | Client's MAC Address : <input type="text"/> : <input type="text"/> : <input type="text"/> : <input type="text"/> : <input type="text"/> : <input type="text"/> |                                                                                                |                                                                                       |
|                                                                                  | <input type="button" value="Add"/> <input type="button" value="Delete"/> <input type="button" value="Edit"/> <input type="button" value="Cancel"/>             |                                                                                                |                                                                                       |
| <b>Bandwidth Limit</b>                                                           |                                                                                                                                                                |                                                                                                |                                                                                       |
| Status                                                                           | <input type="radio"/> Enable <input checked="" type="radio"/> Disable                                                                                          |                                                                                                | Auto Adjustment <input type="radio"/> Enable <input checked="" type="radio"/> Disable |
| Upload                                                                           | 0                                                                                                                                                              | Kbps                                                                                           | Download 0 Kbps                                                                       |
| <b>Station Control</b>                                                           |                                                                                                                                                                |                                                                                                |                                                                                       |
| Status                                                                           | <input type="radio"/> Enable <input checked="" type="radio"/> Disable                                                                                          |                                                                                                |                                                                                       |
| Connection Time                                                                  | 1 hour ▼                                                                                                                                                       | Reconnection Time                                                                              | 1 hour ▼                                                                              |

Note:  
5GHz-2 SSID Configuration only work with Tri-Band AP.

Backup ACL Cfg: 
 Upload From File:  未選擇任何檔案

- When you finished the above web page configuration, click Finish to exit and return to the first page. The modified WLAN profile will be shown on the web page.

Central Management >> AP >> WLAN Profile

|         |         |               |              |            |          |           |       |       |          | <a href="#">Set to Factory Default</a> |
|---------|---------|---------------|--------------|------------|----------|-----------|-------|-------|----------|----------------------------------------|
| Profile | Name    | Main SSID     | Security     | Multi-SSID | WLAN ACL | Rate Ctrl | Clone | To AP | To Local |                                        |
| 1       | Default | DrayTek-LAN-A | WPA+WPA2/PSK | Enable     | None     | None      |       |       |          |                                        |
| 2       | ---     | ---           | ---          | ---        | ---      | ---       | ---   | ---   | ---      | ---                                    |
| 3       | ---     | ---           | ---          | ---        | ---      | ---       | ---   | ---   | ---      | ---                                    |
| 4       | ---     | ---           | ---          | ---        | ---      | ---       | ---   | ---   | ---      | ---                                    |
| 5       | ---     | ---           | ---          | ---        | ---      | ---       | ---   | ---   | ---      | ---                                    |

## VII-6-4 AP Maintenance

Vigor router can execute configuration backup, configuration restoration, firmware upgrade and remote reboot for the APs managed by the router. It is very convenient for the administrator to process maintenance without accessing into the web user interface of the access point.



### Info

Config Backup can be performed to one AP at one time. Others functions (e.g., Config Restore, Firmware Upgrade, Remote Reboot can be performed to more than one AP at one time by using Vigor2927.

Central Management >> AP >> AP Maintenance

**AP Maintenance**

**Select Action**  
 Action Type:    
 File/Path:  未選擇任何檔案

**Select Device**  
 Existing Device:   
 Selected Device:

Available settings are explained as follows:

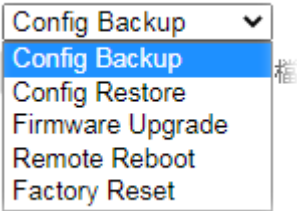
| Item          | Description                                                                                                                                                                                                                                                                                                                                                                                                                      |
|---------------|----------------------------------------------------------------------------------------------------------------------------------------------------------------------------------------------------------------------------------------------------------------------------------------------------------------------------------------------------------------------------------------------------------------------------------|
| Action        | <p>There are four actions provided by Vigor router to manage the access points.</p>  <p>Vigor router can backup the configuration of the selected AP, restore the configuration for the selected AP, perform the firmware upgrade of the selected AP, reboot the selected AP remotely and perform the factory reset for the selected AP.</p> |
| File/Path     | Specify the file and the path which will be used to perform Config Restore or Firmware Upgrade.                                                                                                                                                                                                                                                                                                                                  |
| Select Device | Display all the available access points managed by Vigor router. Simply click << or >> to move the device(s) between Select Device and Selected Device areas.                                                                                                                                                                                                                                                                    |

|                 |                                                                                    |
|-----------------|------------------------------------------------------------------------------------|
| Selected Device | Display the access points that will be applied by such function after clicking OK. |
|-----------------|------------------------------------------------------------------------------------|

After finishing all the settings here, please click OK to perform the action.

## VII-6-5 Traffic Graph

Click Traffic Graph to open the web page. Choose one of the managed Access Points, LAN-A or LAN-B, daily or weekly for viewing data transmission chart. Click Refresh to renew the graph at any time.

Central Management >> AP >> Traffic Graph

Enable

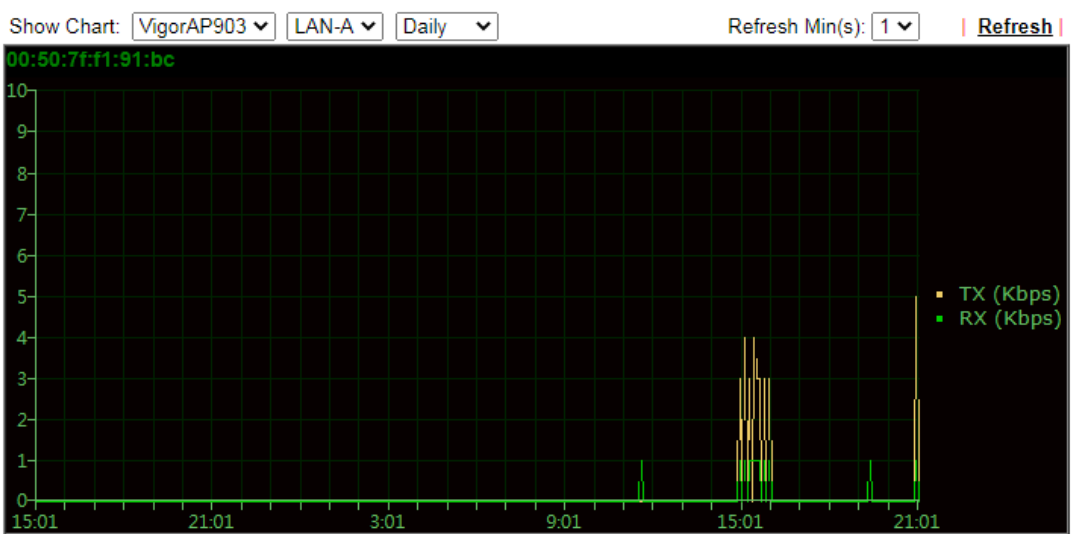

**Note:**

Enabling/Disabling AP Traffic Graph will also Enable/Disable the External Devices Function.

The horizontal axis represents time; the vertical axis represents the transmission rate (in kbps).



**Info**

Enabling/disabling such function will also enable/disable the External Devices function.

## VII-6-6 Event Log

Time and event log for all of the APs managed by Vigor router will be shown on this page. It is useful for troubleshooting if required.

Central Management >> AP >> Event Log

All Event Log

[Clear](#) | [Refresh](#)

| Time                | APM Event Log                                                      |
|---------------------|--------------------------------------------------------------------|
| 2000-01-12 00:34:50 | [APM] [MK-AP 902_3D5490] Query Status success                      |
| 2000-01-12 00:34:53 | [APM] [MK-AP 902_3D5490] Apply Load Balance settings success       |
| 2000-01-12 00:35:19 | [APM] [MK-AP 902_3D5490] Apply Rogue AP Detection settings success |
| 2000-01-12 00:35:49 | [APM] [MK-AP 902_3D5490] GET temper/traffic index success          |
| 2000-01-12 00:35:54 | [APM] [MK-AP 902_3D5490] Query Status success                      |
| 2000-01-12 00:36:10 | [APM] [MK-AP 902_3D5490] GET temper/traffic data success           |
| 2000-01-12 00:36:54 | [APM] [MK-AP 902_3D5490] Query Status success                      |
| 2000-01-12 00:37:53 | [APM] [MK-AP 902_3D5490] Query Status success                      |
| 2000-01-12 00:38:53 | [APM] [MK-AP 902_3D5490] Query Status success                      |
| 2000-01-12 00:39:52 | [APM] [MK-AP 902_3D5490] Query Status success                      |
| 2000-01-12 00:40:52 | [APM] [MK-AP 902_3D5490] Query Status success                      |
| 2000-01-12 00:41:08 | [APM] [MK-AP 902_3D5490] GET temper/traffic data success           |
| 2000-01-12 00:41:22 | [APM] [MK-AP 902_3D5490] Query Status success                      |
| 2000-01-12 00:42:25 | [APM] [MK-AP 902_3D5490] Query Status success                      |
| 2000-01-12 00:46:06 | [APM] [MK-AP 902_3D5490] GET temper/traffic data success           |
| 2000-01-12 00:51:03 | [APM] [MK-AP 902_3D5490] GET temper/traffic data success           |
| 2000-01-12 00:56:01 | [APM] [MK-AP 902_3D5490] GET temper/traffic data success           |
| 2000-01-12 01:00:59 | [APM] [MK-AP 902_3D5490] GET temper/traffic data success           |
| 2000-01-12 01:05:57 | [APM] [MK-AP 902_3D5490] GET temper/traffic data success           |
| 2000-01-12 01:10:55 | [APM] [MK-AP 902_3D5490] GET temper/traffic data success           |
| 2000-01-12 01:15:53 | [APM] [MK-AP 902_3D5490] GET temper/traffic data success           |
| 2000-01-12 01:16:07 | [APM] [MK-AP 902_3D5490] Query Status success                      |
| 2000-01-12 01:18:21 | [APM] [MK-AP 902_3D5490] Query Status success                      |
| 2000-01-12 01:20:45 | [APM] [MK-AP 902_3D5490] GET temper/traffic data success           |
| 2000-01-12 01:21:13 | [APM] [MK-AP 902_3D5490] GET temper/traffic data success           |
| 2000-01-12 01:23:10 | [APM] [MK-AP 902_3D5490] Apply Rogue AP Detection settings success |
| 2000-01-12 01:25:01 | [APM] [MK-AP 902_3D5490] Get Rogue AP Detection data failed        |
| 2000-01-12 01:25:22 | [APM] [MK-AP 902_3D5490] Get Rogue AP Detection data failed        |
| 2000-01-12 01:25:42 | [APM] [MK-AP 902_3D5490] Get Rogue AP Detection data failed        |
| 2000-01-12 01:26:03 | [APM] [MK-AP 902_3D5490] Get Rogue AP Detection data failed        |
| 2000-01-12 01:26:09 | [APM] [MK-AP 902_3D5490] GET temper/traffic data success           |
| 2000-01-12 01:26:23 | [APM] [MK-AP 902_3D5490] Get Rogue AP Detection data failed        |

**Note:**

1. Only browser supporting [HTML5](#) can display Event Log correctly.
2. The APs Log can be refreshed after at least 30 seconds.

## VII-6-7 Total Traffic

Such page will display the total traffic of data receiving and data transmitting for VigorAPs managed by Vigor router.

Central Management >> AP >> Total Traffic

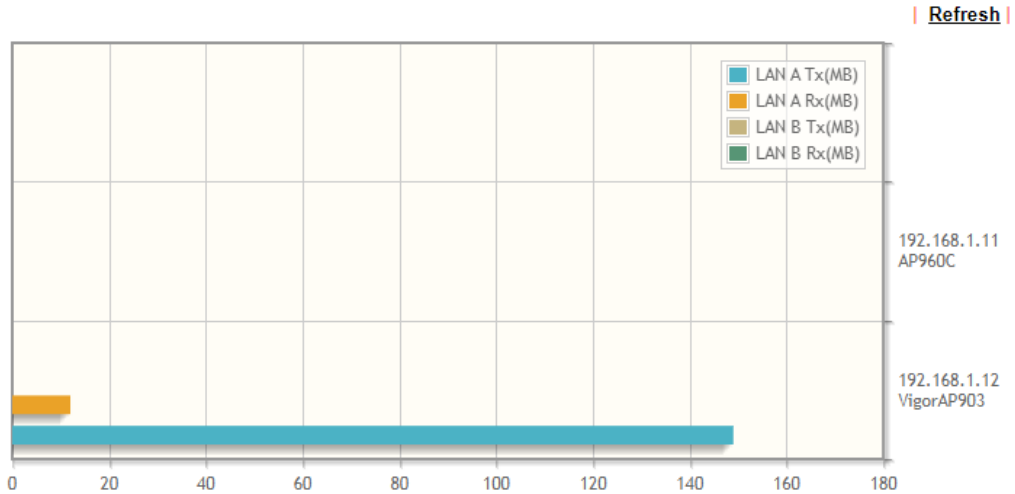

**Note:**  
Only browser supporting [HTML5](#) can display Total Traffic correctly.

## VII-6-8 Station Number

The total number of the wireless clients will be shown on this page, no matter what mode of wireless connection (2.4G WLAN or 5G WLAN) used by wireless clients to access into Internet through VigorAP.

Central Management >> AP >> Station Number

Hourly Records(2 Hours)

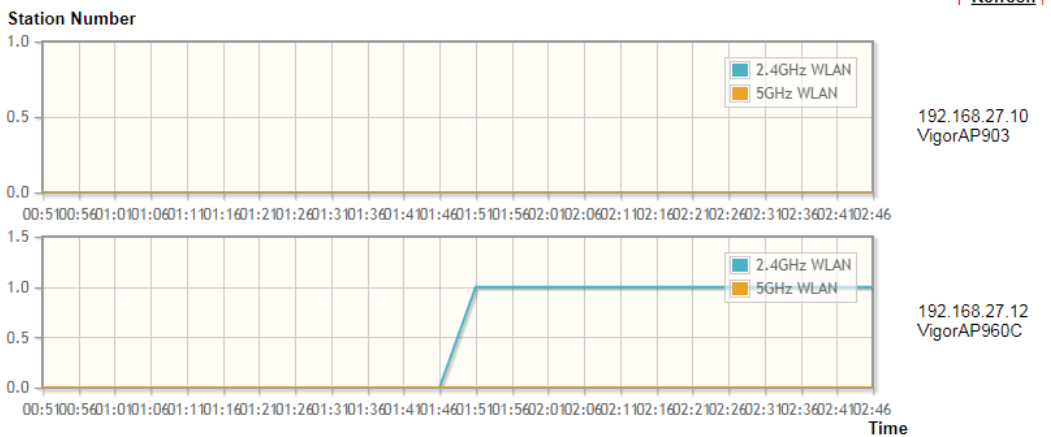

**Note:**  
Only browser supporting [HTML5](#) can display Station Number correctly.

## VII-6-9 Load Balance

The parameters configured for Load Balance can help to distribute the traffic for all of the access points registered to Vigor router. Thus, the bandwidth will not be occupied by certain access points.

Central Management >> AP >> Load Balance

**AP Load Balance** By Station Number or Traffic ▾

---

**Station Number Threshold**

Wireless LAN (2.4GHz)  (3-128)

Wireless LAN (5GHz)  (3-128)

Wireless LAN (5GHz-2)  (3-128)

---

**Traffic Threshold**

Upload Limit User defined ▾  bps (Default unit: K)

Download Limit User defined ▾  bps (Default unit: K)

---

**Action When Threshold Exceeded**

Stop accepting new connections

Dissociate existing station by longest idle time

Dissociate existing station by worst signal strength if it is less than  dBm ( %)

---

**Choose to Apply**

All APs ▾

All APs

Specific APs

Note:

The maximum station number of Wireless LAN (2.4GHz) will be applied to both Wireless LAN (2.4GHz) and Wireless LAN (5GHz) if the firmware version of AP900 is less than or equal to 1.1.4.1.

Available settings are explained as follows:

| Item                     | Description                                                                                                                                                                                                                                                                                                                                                                                                                                                                                                                                                                                                                                                                                                                                                                                                                                                                    |
|--------------------------|--------------------------------------------------------------------------------------------------------------------------------------------------------------------------------------------------------------------------------------------------------------------------------------------------------------------------------------------------------------------------------------------------------------------------------------------------------------------------------------------------------------------------------------------------------------------------------------------------------------------------------------------------------------------------------------------------------------------------------------------------------------------------------------------------------------------------------------------------------------------------------|
| AP Load Balance          | <p>It is used to determine the operation mode when the system detects overload between access points.</p> <p>Disable - Disable the function of AP load balance.</p> <p>By Station Number -The operation of load balance will be executed based on the station number configured in this page. It is used to limit the allowed number for the station connecting to the access point. The purpose is to prevent lots of stations connecting to access point at the same time and causing traffic unbalanced. Please define the required station number for WLAN (2.4GHz) and WLAN (5GHz) separately.</p> <p>By Traffic - The operation of load balance will be executed according to the traffic configuration in this page.</p> <p>By Station Number or Traffic - The operation of load balance will be executed based on the station number or the traffic configuration.</p> |
| Station Number Threshold | Set the number of stations as a threshold to activate AP load balance.                                                                                                                                                                                                                                                                                                                                                                                                                                                                                                                                                                                                                                                                                                                                                                                                         |

|                                |                                                                                                                                                                                                                                                                                                                                                                                                                                                                                                                                                                                                                                                                                                                                                                           |
|--------------------------------|---------------------------------------------------------------------------------------------------------------------------------------------------------------------------------------------------------------------------------------------------------------------------------------------------------------------------------------------------------------------------------------------------------------------------------------------------------------------------------------------------------------------------------------------------------------------------------------------------------------------------------------------------------------------------------------------------------------------------------------------------------------------------|
| Traffic Threshold              | <p>Upload Limit -Use the drop down list to specify the traffic limit for uploading.</p> <p>Download Limit - Use the drop down list to specify the traffic limit for downloading.</p>                                                                                                                                                                                                                                                                                                                                                                                                                                                                                                                                                                                      |
| Action When Threshold Exceeded | <p>Stop accepting new connections - When the number of stations or the traffic reaches the threshold defined in this web page, Vigor router will stop any new connection asked by other access point.</p> <p>Dissociate existing station by longest idel time - When the access point is overload (e.g., reaching the limit of station number or limit of network traffic), it will terminate the network connection of the client's station which is idle for a longest time.</p> <p>Dissociate existing station by worst signal strength if it is less than - When the access point is overload (e.g., reaching the limit of station number or limit of network traffic), it will terminate the network connection of the client's station with the weakest signal.</p> |
| Choose to Apply                | <p>Determine which AP shall be applied with the load balance.</p> <p>All APs - All APs shall be applied with the load balance.</p> <p>Specific APs - The function of load balance will be applied to the AP specified in this field.</p>                                                                                                                                                                                                                                                                                                                                                                                                                                                                                                                                  |

After finishing all the settings here, please click OK to save the configuration.



---

## VII-7 Central Management (Switch)

Vigor router can manage lots of VigorSwitch devices connected to it. Through profile and group settings, the administrator can execute firmware/configuration backup, restore for VigorSwitch device, reboot the device or return to factory default settings of VigorSwitch at one time.

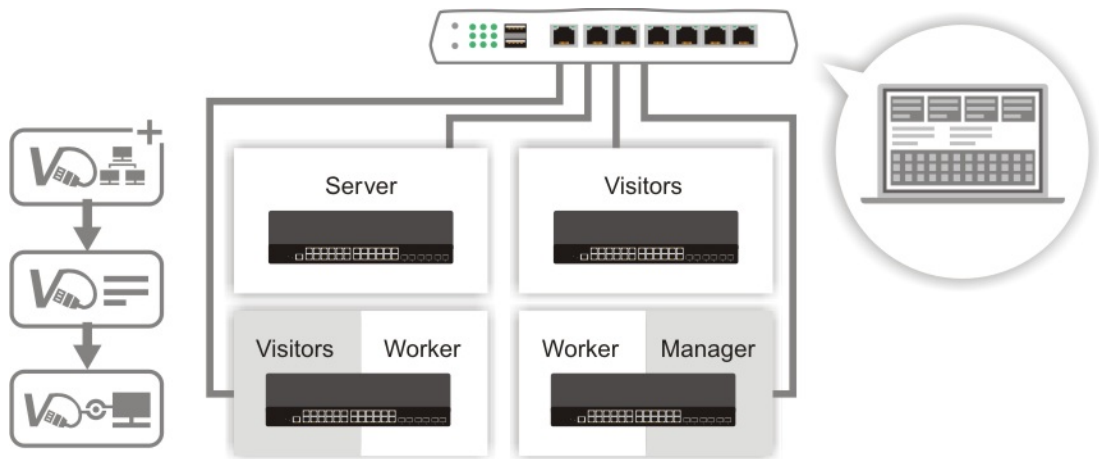

---

# Web User Interface



---

## VII-7-1 Status

### VII-7-1-1 Switch Status

Such page displays information, including Group, Switch name, IP address, model, System Up Time, Port in Use, Clients, and Firmware Version of VigorSwitch connected to Vigor2927 series.

Central Management >> Switch >> Status

---

Switch Status    Switch Hierarchy    Detailed Info    TR069 Setting    Refresh

View Group: All

Status

| Group | Switch Name | IP Address | Model | System Uptime | Port in Use | Clients | Firmware Version | Last Process Status |
|-------|-------------|------------|-------|---------------|-------------|---------|------------------|---------------------|
|-------|-------------|------------|-------|---------------|-------------|---------|------------------|---------------------|

New Switch List

| Index | Switch Name | IP Address   | MAC Address       | Model | Firmware Version | Add Device |
|-------|-------------|--------------|-------------------|-------|------------------|------------|
| 1     | G2121       | 192.168.1.13 | 14:49:BC:41:33:F4 | G2121 | 2.6.7            | Add New    |

Note:  
Supported VigorSwitch model and firmware version

Before checking the switch status, go to Central Management>>External Device to enable External Device Auto Discovery. Wait for the system to display available device(s).

Central Management >> External Devices

- External Device Syslog
- External Device Auto Discovery
  - Enable Switch Management

External Devices Connected

[Refresh](#)

Below shows available devices that connected externally:

|                         |                                                                                    |                                        |                                      |
|-------------------------|------------------------------------------------------------------------------------|----------------------------------------|--------------------------------------|
| <a href="#">On Line</a> | VigorAP903, VigorAP903, Connection Uptime:01:13:05<br>IP Address:192.168.1.12:80   | <input type="button" value="Account"/> | <input type="button" value="Clear"/> |
| <a href="#">On Line</a> | VigorAP960C, VigorAP960C, Connection Uptime:01:13:05<br>IP Address:192.168.1.11:80 | <input type="button" value="Account"/> | <input type="button" value="Clear"/> |
| <a href="#">On Line</a> | G2121, Connection Uptime:00:00:25<br>IP Address:192.168.1.13:80                    | <input type="button" value="Account"/> | <input type="button" value="Clear"/> |

**For security reason:**

If you have changed the administrator password on External Device, please click the **Account** button to retype new username and password. Otherwise, the router will be unable to monitor the External Device device properly. Click the **Clear** button to Clear the off-line information and account information.

**Note:**

Only one router in a network is permitted to have External Device Auto Discovery enabled.

Later, open Central Management>>Switch>>Status. Available VigorSwitch to be managed by such router will be listed under the New Switch List.

Central Management >> Switch >> Status

| Switch Status          | Switch Hierarchy | Detailed Info                | TR069 Setting     |               |                  |                                        |                  | <a href="#">Refresh</a>                      |
|------------------------|------------------|------------------------------|-------------------|---------------|------------------|----------------------------------------|------------------|----------------------------------------------|
|                        |                  |                              |                   |               |                  |                                        |                  | View Group: <input type="text" value="All"/> |
| <b>Status</b>          |                  |                              |                   |               |                  |                                        |                  |                                              |
| Group                  | Switch Name      | IP Address                   | Model             | System Uptime | Port in Use      | Clients                                | Firmware Version | Last Process Status                          |
| <b>New Switch List</b> |                  |                              |                   |               |                  |                                        |                  |                                              |
| Index                  | Switch Name      | IP Address                   | MAC Address       | Model         | Firmware Version | Add Device                             |                  |                                              |
| 1                      | G2121            | <a href="#">192.168.1.13</a> | 14:49:BC:41:33:F4 | G2121         | 2.6.7            | <input type="button" value="Add New"/> |                  |                                              |

**Note:**

[Supported VigorSwitch model and firmware version](#)



**Info**

VigorSwitch listed below Status means the switch is managed by Vigor router; VigorSwitch listed below New Switch List means it is not managed by Vigor2927 yet.

Click Add to make the selected VigorSwitch to be managed by Vigor router.

Central Management >> Switch >> Status

| Switch Status | Switch Hierarchy | Detailed Info                | TR069 Setting |               |             |         |                  |                      | <a href="#">Refresh</a>                      |
|---------------|------------------|------------------------------|---------------|---------------|-------------|---------|------------------|----------------------|----------------------------------------------|
|               |                  |                              |               |               |             |         |                  |                      | View Group: <input type="text" value="All"/> |
| <b>Status</b> |                  |                              |               |               |             |         |                  |                      |                                              |
| Group         | Switch Name      | IP Address                   | Model         | System Uptime | Port in Use | Clients | Firmware Version | Last Process Status  |                                              |
| Default       | G2121            | <a href="#">192.168.1.13</a> | G2121         | 0:03:14       | 1/12        | 0       | 2.6.7            | Process Successfully |                                              |

**Note:**

[Supported VigorSwitch model and firmware version](#)

Available settings are explained as follows:

| Item             | Description                                                                                                                                                                                                                                                                                                                                                                                                                                                                                                                                                                                                                                                                                                                                                                                                                                                                                                                                                                                                                                                                                                                                                                                                                                                                                                                                                                                                                                                                                                                                                                                                                                                                                                                                                                                                                                                                                         |              |                   |            |                  |            |                  |            |   |       |              |                   |       |       |         |
|------------------|-----------------------------------------------------------------------------------------------------------------------------------------------------------------------------------------------------------------------------------------------------------------------------------------------------------------------------------------------------------------------------------------------------------------------------------------------------------------------------------------------------------------------------------------------------------------------------------------------------------------------------------------------------------------------------------------------------------------------------------------------------------------------------------------------------------------------------------------------------------------------------------------------------------------------------------------------------------------------------------------------------------------------------------------------------------------------------------------------------------------------------------------------------------------------------------------------------------------------------------------------------------------------------------------------------------------------------------------------------------------------------------------------------------------------------------------------------------------------------------------------------------------------------------------------------------------------------------------------------------------------------------------------------------------------------------------------------------------------------------------------------------------------------------------------------------------------------------------------------------------------------------------------------|--------------|-------------------|------------|------------------|------------|------------------|------------|---|-------|--------------|-------------------|-------|-------|---------|
| Group            | Display the name link of the group.<br>You can click the link to modify the group settings if required.                                                                                                                                                                                                                                                                                                                                                                                                                                                                                                                                                                                                                                                                                                                                                                                                                                                                                                                                                                                                                                                                                                                                                                                                                                                                                                                                                                                                                                                                                                                                                                                                                                                                                                                                                                                             |              |                   |            |                  |            |                  |            |   |       |              |                   |       |       |         |
| Switch Name      | Display the name link of VigorSwitch.<br>You can click the name link to access into the switch profile.                                                                                                                                                                                                                                                                                                                                                                                                                                                                                                                                                                                                                                                                                                                                                                                                                                                                                                                                                                                                                                                                                                                                                                                                                                                                                                                                                                                                                                                                                                                                                                                                                                                                                                                                                                                             |              |                   |            |                  |            |                  |            |   |       |              |                   |       |       |         |
| IP Address       | Display the IP address of VigorSwitch.                                                                                                                                                                                                                                                                                                                                                                                                                                                                                                                                                                                                                                                                                                                                                                                                                                                                                                                                                                                                                                                                                                                                                                                                                                                                                                                                                                                                                                                                                                                                                                                                                                                                                                                                                                                                                                                              |              |                   |            |                  |            |                  |            |   |       |              |                   |       |       |         |
| Model            | Display the model name of VigorSwitch.                                                                                                                                                                                                                                                                                                                                                                                                                                                                                                                                                                                                                                                                                                                                                                                                                                                                                                                                                                                                                                                                                                                                                                                                                                                                                                                                                                                                                                                                                                                                                                                                                                                                                                                                                                                                                                                              |              |                   |            |                  |            |                  |            |   |       |              |                   |       |       |         |
| System Up Time   | Display the time accumulated since this Vigorwitch is powered up.                                                                                                                                                                                                                                                                                                                                                                                                                                                                                                                                                                                                                                                                                                                                                                                                                                                                                                                                                                                                                                                                                                                                                                                                                                                                                                                                                                                                                                                                                                                                                                                                                                                                                                                                                                                                                                   |              |                   |            |                  |            |                  |            |   |       |              |                   |       |       |         |
| Port in Use      | Display how many devices connected to VigorSwitch.                                                                                                                                                                                                                                                                                                                                                                                                                                                                                                                                                                                                                                                                                                                                                                                                                                                                                                                                                                                                                                                                                                                                                                                                                                                                                                                                                                                                                                                                                                                                                                                                                                                                                                                                                                                                                                                  |              |                   |            |                  |            |                  |            |   |       |              |                   |       |       |         |
| Clients          | Display the number of LAN ports used in VigorSwitch.                                                                                                                                                                                                                                                                                                                                                                                                                                                                                                                                                                                                                                                                                                                                                                                                                                                                                                                                                                                                                                                                                                                                                                                                                                                                                                                                                                                                                                                                                                                                                                                                                                                                                                                                                                                                                                                |              |                   |            |                  |            |                  |            |   |       |              |                   |       |       |         |
| Firmware Version | Display the firmware version that VigorSwitch current used.                                                                                                                                                                                                                                                                                                                                                                                                                                                                                                                                                                                                                                                                                                                                                                                                                                                                                                                                                                                                                                                                                                                                                                                                                                                                                                                                                                                                                                                                                                                                                                                                                                                                                                                                                                                                                                         |              |                   |            |                  |            |                  |            |   |       |              |                   |       |       |         |
| Add              | Such button will appear only when there is more than one switch connected to Vigor2927.<br>The one under New Switch List is allowed to be managed under current used group. Simply click Add.<br><br><div style="border: 1px solid #ccc; padding: 5px; margin-bottom: 5px;"> <p style="margin: 0;">Central Management &gt;&gt; Switch &gt;&gt; Status</p> <hr/> <div style="display: flex; justify-content: space-between; border-bottom: 1px solid #ccc; margin-bottom: 5px;"> <span>Switch Status</span> <span>Switch Hierarchy</span> <span>Detailed Info</span> <span>TR069 Setting</span> <span style="color: red;">Refresh</span> </div> <div style="display: flex; justify-content: flex-end; margin-bottom: 5px;"> <span>View Group: All</span> </div> <div style="display: flex; justify-content: space-between; border-bottom: 1px solid #ccc; margin-bottom: 5px;"> <span>Status</span> </div> <div style="display: flex; justify-content: space-between; border-bottom: 1px solid #ccc; margin-bottom: 5px;"> <span>Group</span> <span>Switch Name</span> <span>IP Address</span> <span>Model</span> <span>System Up Time</span> <span>Port in Use</span> <span>Clients</span> <span>Firmware Version</span> <span>Last Process Status</span> </div> <div style="margin-bottom: 5px;"> <p><b>New Switch List</b></p> <table border="1" style="width: 100%; border-collapse: collapse;"> <thead> <tr> <th>Index</th> <th>Switch Name</th> <th>IP Address</th> <th>MAC Address</th> <th>Model</th> <th>Firmware Version</th> <th>Add Device</th> </tr> </thead> <tbody> <tr> <td>1</td> <td>G2280</td> <td style="color: green;">192.168.1.11</td> <td>00:1D:AA:0C:CD:08</td> <td>G2280</td> <td>2.6.6</td> <td>Add New</td> </tr> </tbody> </table> </div> <p style="font-size: small; margin: 0;">Note:<br/><a href="#">Supported VigorSwitch model and firmware version</a></p> </div> | Index        | Switch Name       | IP Address | MAC Address      | Model      | Firmware Version | Add Device | 1 | G2280 | 192.168.1.11 | 00:1D:AA:0C:CD:08 | G2280 | 2.6.6 | Add New |
| Index            | Switch Name                                                                                                                                                                                                                                                                                                                                                                                                                                                                                                                                                                                                                                                                                                                                                                                                                                                                                                                                                                                                                                                                                                                                                                                                                                                                                                                                                                                                                                                                                                                                                                                                                                                                                                                                                                                                                                                                                         | IP Address   | MAC Address       | Model      | Firmware Version | Add Device |                  |            |   |       |              |                   |       |       |         |
| 1                | G2280                                                                                                                                                                                                                                                                                                                                                                                                                                                                                                                                                                                                                                                                                                                                                                                                                                                                                                                                                                                                                                                                                                                                                                                                                                                                                                                                                                                                                                                                                                                                                                                                                                                                                                                                                                                                                                                                                               | 192.168.1.11 | 00:1D:AA:0C:CD:08 | G2280      | 2.6.6            | Add New    |                  |            |   |       |              |                   |       |       |         |
|                  | It will be better to group VigorSwitch devices with the same model.                                                                                                                                                                                                                                                                                                                                                                                                                                                                                                                                                                                                                                                                                                                                                                                                                                                                                                                                                                                                                                                                                                                                                                                                                                                                                                                                                                                                                                                                                                                                                                                                                                                                                                                                                                                                                                 |              |                   |            |                  |            |                  |            |   |       |              |                   |       |       |         |

## VII-7-1-2 Switch Hierarchy

Such page displays the hierarchy of VigorSwitch(es) managed under Vigor2927.

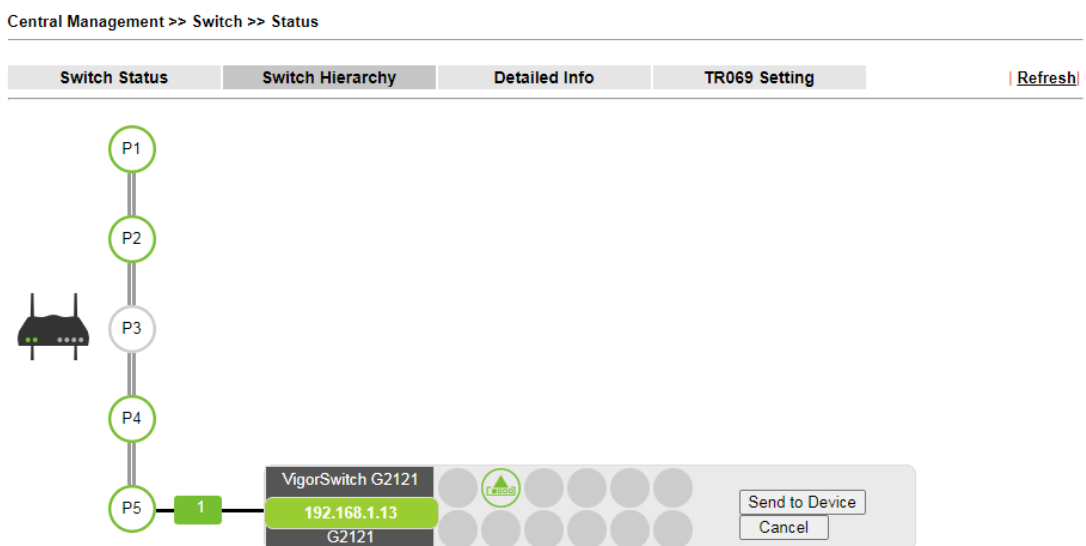

Switch Status
Switch Hierarchy
Detailed Info
TR069 Setting
[Refresh](#)

Please note that, Shutdown Port is available for LAN port of VigorSwitch connects to a LAN device. When it is checked, after clicking OK, the network connection between that device and VigorSwitch will be terminated.

### VII-7-1-3 Detailed Info

This page displays the hierarchy of VigorSwitch(es) managed under Vigor2927.

Switch Status
Switch Hierarchy
Detailed Info
TR069 Setting
[Refresh](#)

Switch List

| Index | Switch Name           | IP           | Model | MAC               |
|-------|-----------------------|--------------|-------|-------------------|
| 1     | <a href="#">G2121</a> | 192.168.1.13 | G2121 | 14:49:BC:41:33:F4 |

Search

| Uplink Device | Port | IP           | MAC               | Name/Description |
|---------------|------|--------------|-------------------|------------------|
| Vigor Router  | 5    | 192.168.1.13 | 14:49:BC:41:33:F4 | G2121            |

**Note:**  
Vigor router only temporarily records the IP address and MAC address of the client connects to the switch, record will be discarded after the client leaves the network.

Available settings are explained as follows:

| Item        | Description                                                                                                                                                                                                    |
|-------------|----------------------------------------------------------------------------------------------------------------------------------------------------------------------------------------------------------------|
| Switch List | Displays the index number, switch name, IP address, model name and MAC address of the VigorSwitch device.<br>Switch Name - The name link allows you to access into the web user interface of the Vigor Switch. |

|        |                                                                                                                                                                                                                                                                                                                                                                                                                                                  |
|--------|--------------------------------------------------------------------------------------------------------------------------------------------------------------------------------------------------------------------------------------------------------------------------------------------------------------------------------------------------------------------------------------------------------------------------------------------------|
|        | <p>IP - Displays the IP address of the switch.</p> <p>Model - Displays the model name of the switch.</p> <p>MAC - Displays the MAC address of the switch.</p>                                                                                                                                                                                                                                                                                    |
| Search | <p>Search - After specifying IP address, MAC address or name of the switch, click the Search button to find out the device and display the searching result on this page.</p> <p>Uplink Device - Displays the name of the server that Vigor switch connects to.</p> <p>Port - Indicates the port where the switch is connected to the router. This number link allows you to click to view more detailed information of the searched device.</p> |

Click the port number link (e.g., 3) to open the following page. Detailed information of the name, port number, IP address, MAC address, description, type, VLAN number, PVID value and PoE capability of the switch will be shown on this page.

Central Management >> Switch >> Status

Switch Status    Switch Hierarchy    Detailed Info    TR069 Setting    [Refresh](#)

Switch List

| Index | Switch Name           | IP           | Model | MAC               |
|-------|-----------------------|--------------|-------|-------------------|
| 1     | <a href="#">G2121</a> | 192.168.1.13 | G2121 | 14:49:BC:41:33:F4 |

Search

IP

G2121

| Switch | Port | IP  | MAC | Description | Type   | VLAN | PVID | PoE |
|--------|------|-----|-----|-------------|--------|------|------|-----|
| G2121  | 5    | --- | --- | phone676    | access | 1    | 1    | --- |

Devices Connect to this port

| Index | IP  | MAC | Netbios Name |
|-------|-----|-----|--------------|
| 1     | --- | --- | ---          |

In addition, this page will display the basic information (IP address, MAC address and Netbios Name) of "other" devices connected to this switch.

### VII-7-1-4 TR069 Setting

In addition to HTTP/HTTPS, the Vigor router is able to manage the VigorSwitch with the protocol of TR-069.

Central Management >> Switch >> Status

Switch Status    Switch Hierarchy    Detailed Info    TR069 Setting    [Refresh](#)

SWM PORT

Username

Password

Available settings are explained as follows:

| Item     | Description                                                                                             |
|----------|---------------------------------------------------------------------------------------------------------|
| SWM Port | The default value is 8003. In the event of port conflicts, change the port number.                      |
| Username | Displays the username that the Vigor switch will use to connect to this router. Keep the default value. |
| Password | Displays the password that the Vigor switch will use to connect to this router. Keep the default value. |

## VII-7-2 Profile

This page will show general information, such as name, group, IP address, MAC address, model and password of VigorSwitch only when it connects to Vigor2927 series. By clicking the index number link, a profile setting page for that switch will be shown. Note that each profile represents one VigorSwitch.

Central Management >> Switch >> Profile



### Profile List

| Index             | Name  | Group    | IP Address                   | MAC Address       | Model | Password                                | Process Status       | Delete Profile                   |
|-------------------|-------|----------|------------------------------|-------------------|-------|-----------------------------------------|----------------------|----------------------------------|
| <a href="#">1</a> | G2280 | Default, | <a href="#">192.168.1.12</a> | 00:1D:AA:0C:CD:08 | G2280 | <input type="button" value="Password"/> | Process Successfully | <input type="button" value="X"/> |

Available settings are explained as follows:

| Item           | Description                                                                                                                                                                                                                                            |
|----------------|--------------------------------------------------------------------------------------------------------------------------------------------------------------------------------------------------------------------------------------------------------|
| Index          | Click the number link to access into the switch profile.<br>Note: Each connected VigorSwitch will have one setting profile. If there are many switches connected to Vigor2927, different index number will be used to represent different VigorSwitch. |
| Name           | Display the user defined name of VigorSwitch.                                                                                                                                                                                                          |
| Group          | Display the group name of VigorSwitch(es).                                                                                                                                                                                                             |
| IP Address     | Display the IP address of VigorSwitch.                                                                                                                                                                                                                 |
| MAC Address    | Display the MAC address of VigorSwitch.                                                                                                                                                                                                                |
| Model          | Display the model name of VigorSwitch.                                                                                                                                                                                                                 |
| Password       | Click it to display the account information including username and password.                                                                                                                                                                           |
| Delete Profile | Click the mark of "X" to delete the switch profile.                                                                                                                                                                                                    |

To edit profile for the selected switch:

1. Click index number link (e.g. #1) to open the following page.

Central Management >> Switch >> Profile

| [Get Setting from External Switch](#) |

| [Set to Factory Default](#) |

| General        | VLAN                                                                       | Port |
|----------------|----------------------------------------------------------------------------|------|
| Switch Name    | <input type="text" value="G2121"/>                                         |      |
| Comment        | <input type="text" value="where_can_be"/>                                  |      |
| Login Password | <input type="password" value="....."/> <input type="button" value="Show"/> |      |
| IP Address     | DHCP <a href="#">192.168.27.14</a>                                         |      |

**Note:**

The router configuration will be updated when getting profile settings from external switch.  
We will not copy settings of rate limit while copy configuration, because the format of rate limit are different between each model.



Available settings are explained as follows:

| Item           | Description                                                                                                                                                                                                                                                                    |
|----------------|--------------------------------------------------------------------------------------------------------------------------------------------------------------------------------------------------------------------------------------------------------------------------------|
| Switch Name    | Type a name for the Switch. The purpose of name is used for identification.<br>It is useful when there are many VigorSwitch (same modes) devices connecting to Vigor2927 series.                                                                                               |
| Comment        | Enter the text in such field if additional explanation for the switch is required.                                                                                                                                                                                             |
| Login Password | Display the original login password for the VigorSwitch.<br>However, if Group Password (in Central Management >>Switch>>Group) is configured with other string, then such field is not allowed to type any other password. And only the group password will be shown, instead. |
| IP Address     | Display the dynamic IP address (of the connected switch) assigned by Vigor2927.                                                                                                                                                                                                |
| Save           | Click it to save the settings.                                                                                                                                                                                                                                                 |
| Cancel         | Click it to return to previous web page without saving the setting changes.                                                                                                                                                                                                    |
| Send to Device | Click it to transfer the configuration change (e.g, login password, switch name, etc.) to the VigorSwitch immediately.                                                                                                                                                         |

- After finished the settings, click VLAN tab to open following page.

Blank page due to LAN>>VLAN not configured previously:

Central Management >> Switch >> Profile

Switch Profile 1 Switch | Get Setting from External Switch |  
| Set to Factory Default |

General      VLAN      Port

| Router VLAN    |        |     |          | LAN Port |   |   |   | WLAN 2.4G SSID |   |   |   | WLAN 5G SSID |   |   |   |
|----------------|--------|-----|----------|----------|---|---|---|----------------|---|---|---|--------------|---|---|---|
| Tag based VLAN |        |     |          |          |   |   |   |                |   |   |   |              |   |   |   |
| Group          | Subnet | VID | Priority | 1        | 2 | 3 | 4 | 1              | 2 | 3 | 4 | 1            | 2 | 3 | 4 |
|                |        |     |          |          |   |   |   |                |   |   |   |              |   |   |   |

External Switch VLAN

Port Members

Remove Tag (PVID)

**Note:**

The router configuration will be updated when getting profile settings from external switch

Setting page with LAN>>VLAN configured previously:

Central Management >> Switch >> Profile

Switch Profile 1 G2121 | Get Setting from External Switch |  
| Set to Factory Default |

**General**    **VLAN**    **Port**

**Router VLAN**

| Tag based VLAN |        |     |          | LAN Port                            |                                     |                                     |                                     |                                     | WLAN 2.4G SSID           |                          |                          |                          | WLAN 5G SSID             |                          |                          |                          |
|----------------|--------|-----|----------|-------------------------------------|-------------------------------------|-------------------------------------|-------------------------------------|-------------------------------------|--------------------------|--------------------------|--------------------------|--------------------------|--------------------------|--------------------------|--------------------------|--------------------------|
| Group          | Subnet | VID | Priority | 1                                   | 2                                   | 3                                   | 4                                   | 5                                   | 1                        | 2                        | 3                        | 4                        | 1                        | 2                        | 3                        | 4                        |
| VLAN0          | LAN1   | 0   | 0        | <input checked="" type="checkbox"/> | <input checked="" type="checkbox"/> | <input checked="" type="checkbox"/> | <input checked="" type="checkbox"/> | <input checked="" type="checkbox"/> | <input type="checkbox"/> | <input type="checkbox"/> | <input type="checkbox"/> | <input type="checkbox"/> | <input type="checkbox"/> | <input type="checkbox"/> | <input type="checkbox"/> | <input type="checkbox"/> |
| VLAN1          | LAN2   | 20  | 0        | <input type="checkbox"/>            | <input type="checkbox"/>            | <input type="checkbox"/>            | <input type="checkbox"/>            | <input checked="" type="checkbox"/> | <input type="checkbox"/> | <input type="checkbox"/> | <input type="checkbox"/> | <input type="checkbox"/> | <input type="checkbox"/> | <input type="checkbox"/> | <input type="checkbox"/> | <input type="checkbox"/> |

**External Switch VLAN**

**Port Members**

|                   | 1                                   | 2                                   | 3                                   | 4                                   | 5                                   | 6                                   | 7                                   | 8                                   | 9                                   | 10                                  | 11                                  | 12                                  |
|-------------------|-------------------------------------|-------------------------------------|-------------------------------------|-------------------------------------|-------------------------------------|-------------------------------------|-------------------------------------|-------------------------------------|-------------------------------------|-------------------------------------|-------------------------------------|-------------------------------------|
| Remove Tag (PVID) | <input type="checkbox"/>            | <input checked="" type="checkbox"/> | <input checked="" type="checkbox"/> | <input checked="" type="checkbox"/> | <input checked="" type="checkbox"/> | <input checked="" type="checkbox"/> | <input checked="" type="checkbox"/> | <input checked="" type="checkbox"/> | <input checked="" type="checkbox"/> | <input checked="" type="checkbox"/> | <input checked="" type="checkbox"/> | <input checked="" type="checkbox"/> |
| VLAN0 [0]         | <input checked="" type="checkbox"/> | <input checked="" type="checkbox"/> | <input checked="" type="checkbox"/> | <input checked="" type="checkbox"/> | <input checked="" type="checkbox"/> | <input checked="" type="checkbox"/> | <input checked="" type="checkbox"/> | <input checked="" type="checkbox"/> | <input checked="" type="checkbox"/> | <input checked="" type="checkbox"/> | <input checked="" type="checkbox"/> | <input checked="" type="checkbox"/> |
| VLAN1 [20]        | <input checked="" type="checkbox"/> | <input type="checkbox"/>            | <input type="checkbox"/>            | <input type="checkbox"/>            | <input type="checkbox"/>            | <input type="checkbox"/>            | <input type="checkbox"/>            | <input type="checkbox"/>            | <input type="checkbox"/>            | <input type="checkbox"/>            | <input type="checkbox"/>            | <input type="checkbox"/>            |

**Note:**  
The router configuration will be updated when getting profile settings from external switch

- Click Save to save VLAN configuration. Then, click Port tab to access the following page:

Central Management >> Switch >> Profile

Switch Profile 1 G2280 | Get Setting from External Switch |  
| Set to Factory Default |

**General**    **VLAN**    **Port**

| Port | Description | Port Control | Schedule                 |                          | Rate Limit               |                          |
|------|-------------|--------------|--------------------------|--------------------------|--------------------------|--------------------------|
|      |             |              | Ingress Rate(Kbps)       | Egress Rate(Kbps)        | Ingress Rate(Kbps)       | Egress Rate(Kbps)        |
| *    |             | Enable Port  | <input type="checkbox"/> | <input type="checkbox"/> | <input type="checkbox"/> | <input type="checkbox"/> |
| 1    |             | Enable Port  | <input type="checkbox"/> | <input type="checkbox"/> | <input type="checkbox"/> | <input type="checkbox"/> |
| 2    | Uplink      | Enable Port  | <input type="checkbox"/> | <input type="checkbox"/> | <input type="checkbox"/> | <input type="checkbox"/> |
| 3    |             | Enable Port  | <input type="checkbox"/> | <input type="checkbox"/> | <input type="checkbox"/> | <input type="checkbox"/> |
| 4    |             | Enable Port  | <input type="checkbox"/> | <input type="checkbox"/> | <input type="checkbox"/> | <input type="checkbox"/> |
| 5    |             | Enable Port  | <input type="checkbox"/> | <input type="checkbox"/> | <input type="checkbox"/> | <input type="checkbox"/> |
| 6    |             | Enable Port  | <input type="checkbox"/> | <input type="checkbox"/> | <input type="checkbox"/> | <input type="checkbox"/> |
| 7    |             | Enable Port  | <input type="checkbox"/> | <input type="checkbox"/> | <input type="checkbox"/> | <input type="checkbox"/> |
| 8    |             | Enable Port  | <input type="checkbox"/> | <input type="checkbox"/> | <input type="checkbox"/> | <input type="checkbox"/> |
| 9    |             | Enable Port  | <input type="checkbox"/> | <input type="checkbox"/> | <input type="checkbox"/> | <input type="checkbox"/> |
| 10   |             | Enable Port  | <input type="checkbox"/> | <input type="checkbox"/> | <input type="checkbox"/> | <input type="checkbox"/> |
| 11   |             | Enable Port  | <input type="checkbox"/> | <input type="checkbox"/> | <input type="checkbox"/> | <input type="checkbox"/> |
| 12   |             | Enable Port  | <input type="checkbox"/> | <input type="checkbox"/> | <input type="checkbox"/> | <input type="checkbox"/> |
| 13   |             | Enable Port  | <input type="checkbox"/> | <input type="checkbox"/> | <input type="checkbox"/> | <input type="checkbox"/> |
| 14   |             | Enable Port  | <input type="checkbox"/> | <input type="checkbox"/> | <input type="checkbox"/> | <input type="checkbox"/> |
| 15   |             | Enable Port  | <input type="checkbox"/> | <input type="checkbox"/> | <input type="checkbox"/> | <input type="checkbox"/> |
| 16   |             | Enable Port  | <input type="checkbox"/> | <input type="checkbox"/> | <input type="checkbox"/> | <input type="checkbox"/> |

Available settings are explained as follows:

| Item         | Description                                                                                                                                                                                                                                                                                                                                              |
|--------------|----------------------------------------------------------------------------------------------------------------------------------------------------------------------------------------------------------------------------------------------------------------------------------------------------------------------------------------------------------|
| Description  | If required, type a brief description to explain the device connected to VigorSwitch via the LAN port.                                                                                                                                                                                                                                                   |
| Port Control | <p>Disable Port - The port (e.g, Port 2 in this case) which is used to connect VigorSwitch and Vigor2927 will not be shutdown by Vigor2927 series.</p> <p>Other LAN ports of VigorSwitch allow to connect to any LAN device. When it is checked, after clicking Save, the network connection between that device and VigorSwitch will be terminated.</p> |

|            |                                                                                                                                                                                        |
|------------|----------------------------------------------------------------------------------------------------------------------------------------------------------------------------------------|
|            | Schedule - Two schedule profiles can be specified here to force Vigor2927 executing specific action to VigorSwitch.                                                                    |
| Rate Limit | Check the box for typing the ingress rate / egress rate for the selected VigorSwitch. After clicking Save, the value modified in this page will be written to VigorSwitch and enabled. |

- Click Save to save the changes and then click Send to Device. Settings will be sent to VigorSwitch immediately.

Central Management >> Switch >> Profile

Switch Profile 1 SWITCH-G1241 | [Get Setting from External Switch](#) |

General
VLAN
Port
| [Set to Factory Default](#) |

Post Settings to Vigor Switch



Note: The router configuration will be updated when getting profile settings from external switch.  
 Double quotation mark (") is not supported in Description columns.

## VII-7-3 Group

Different switches can be classified into different group(s). Specific password for a group can be defined and applied to every switch under that group.

Through the common password setting, it is not necessary for the system administrator to remember various login passwords to access into different VigorSwitch devices.

Central Management >> Switch >> Group

| Index              | Group Name | Member Switch       |
|--------------------|------------|---------------------|
| <a href="#">1</a>  | Default    | G2280(192.168.1.12) |
| <a href="#">2</a>  |            |                     |
| <a href="#">3</a>  |            |                     |
| <a href="#">4</a>  |            |                     |
| <a href="#">5</a>  |            |                     |
| <a href="#">6</a>  |            |                     |
| <a href="#">7</a>  |            |                     |
| <a href="#">8</a>  |            |                     |
| <a href="#">9</a>  |            |                     |
| <a href="#">10</a> |            |                     |

Click any index number link to create a new switch group.

Index 1:

Available settings are explained as follows:

| Item            | Description                                                                                                                                                                                              |
|-----------------|----------------------------------------------------------------------------------------------------------------------------------------------------------------------------------------------------------|
| Group Name      | Type a name as the group name. Different switches can be classified within a group.                                                                                                                      |
| Group Password  | Type a password that administrator can use to access into the managed VigorSwitch connecting to Vigor2927 series. All of the switches under the same group can be accessed into via such group password. |
| Existing Switch | Display all of the VigorSwitch devices connecting to Vigor2927.                                                                                                                                          |
| Member Switch   | Choose the switches you want to group and click the button ">>" to move the selected devices onto the field of Member Switch. Devices under Member Switch will be grouped under such group profile.      |
| OK              | Click it to save the configuration.                                                                                                                                                                      |
| Cancel          | Click it to exit the setting page without saving any change.                                                                                                                                             |

## VII-7-4 Maintenance

Such feature can execute configuration backup, restore of selected VigorSwitch device(s) or reboot the VigorSwitch devices remotely or reset the VigorSwitch devices with factory default settings, without accessing into the web user interface of VigorSwitch respectively. It is convenient for system administrator to manage VigorSwitch devices.

Central Management >> Switch >> Maintenance

|                    |                                             |
|--------------------|---------------------------------------------|
| Select Action      |                                             |
| Action Type:       | Config Backup ▾                             |
| File/Path:         | <input type="button" value="選擇檔案"/> 未選擇任何檔案 |
| Selected Device    | G2280 ▾                                     |
| Device MAC Address | 00:1d:aa:0c:cd:08                           |
| Device IP Address  | 192.168.1.11                                |

Available settings are explained as follows:

| Item            | Description                                                                                                                                                                                                                          |
|-----------------|--------------------------------------------------------------------------------------------------------------------------------------------------------------------------------------------------------------------------------------|
| Select Action   | Action Type - Four actions including configuration backup, configuration restore, remote reboot and factory reset are offered by Vigor2927 to perform on VigorSwitch.<br>File/Path - Click the button to find out the required file. |
| Selected Device | Use the drop down list to specify a VigorSwitch. Then the MAC address and IP address related to the device will be displayed on this area.                                                                                           |
| OK              | Click it to immediately perform the action (configuration backup, configuration restore, remote reboot and factory reset) on the device(s) listed in Selected Device.                                                                |
| Cancel          | Click it to cancel the setting changes.                                                                                                                                                                                              |

## VII-7-5 Alert and Log

Alert and Log is helpful for the user to understand the abnormal situation occurred in VigorSwitch quickly. When the system detects an error, information of abnormal condition will be recorded to the database; or the system will send an alert to the specified device (via e-mail or SMS) to warn the user.

### VII-7-5-1 Alert Setup

This page is used to define the name of alert, level of alert (in color), and determine to record the data in the database, or send a notification message to the user based on the level.

Central Management >> Switch >> Alert and Log

---

Alert Setup    Switch and Port Setup    Alert Logs

---

Alert and Log [Set to Factory Default](#)

Alert Levels and Action

| Index | Enable                              | Level Name                                                        | Color                         | Create Log                          | Send Notification        | SMS/Email Service object                   |
|-------|-------------------------------------|-------------------------------------------------------------------|-------------------------------|-------------------------------------|--------------------------|--------------------------------------------|
| 1     | <input checked="" type="checkbox"/> | <input type="text" value="No Alert"/><br>max. 15 characters       | No Color                      | No Log                              | No Notification          |                                            |
| 2     | <input checked="" type="checkbox"/> | <input type="text" value="Minor Alert"/><br>max. 15 characters    | <input type="text" value=""/> | Enable                              | No Notification          |                                            |
| 3     | <input checked="" type="checkbox"/> | <input type="text" value="Moderate Alert"/><br>max. 15 characters | <input type="text" value=""/> | <input checked="" type="checkbox"/> | <input type="checkbox"/> | <input type="text" value="sms alert 1 -"/> |

Available settings are explained as follows:

| Item                    | Description                                                                                                                                                                                                                                                                                                                                                                                                                                                                                                                                                                                                                                                                                                                                                                                        |
|-------------------------|----------------------------------------------------------------------------------------------------------------------------------------------------------------------------------------------------------------------------------------------------------------------------------------------------------------------------------------------------------------------------------------------------------------------------------------------------------------------------------------------------------------------------------------------------------------------------------------------------------------------------------------------------------------------------------------------------------------------------------------------------------------------------------------------------|
| Alert and Log           | Check it to enable this feature.                                                                                                                                                                                                                                                                                                                                                                                                                                                                                                                                                                                                                                                                                                                                                                   |
| Alert Levels and Action | <p>Level Name - Define names for representing the severity of alert event. The default names for index 1 to index 4 will be shown on each setting box. Index 5 to index 8 are reserved for user-defined.</p> <p>Color - Define the color for each level of alert. However, the color of index 1 is No color and unable to be changed.</p> <p>Create Log - Check the box to create log of alert. Such log will be seen on Alert Logs page. Note that No Log for index 1; and log for index 2 is enabled in default.</p> <p>Send Notification - If it is checked, Vigor router's system will send notification to specified phone number via SMS.</p> <p>SMS/Email Service Object - Choose the SMS object which will get the SMS from Vigor router. Up to 4 objects can be selected at one time.</p> |

## VII-7-5-2 Switch and Port Setup

This page defines enabling switch alert and/or port alert for each switch.

Central Management >> Switch >> Alert and Log

| Alert Setup |                       | Switch and Port Setup |        | Alert Logs   |            |
|-------------|-----------------------|-----------------------|--------|--------------|------------|
| Index       | Switch Name           | IP                    | Model  | Switch Alert | Port Alert |
| 1           | <a href="#">P2280</a> | 192.168.1.11          | P2280x | Enable ▾     | Enable ▾   |

Available settings are explained as follows:

| Item         | Description                                                               |
|--------------|---------------------------------------------------------------------------|
| Switch Alert | Enable - Check it to enable alert mechanism for VigorSwitch.              |
| Port Alert   | Enable - Check it to enable alert mechanism for each port of VigorSwitch. |

Click the Switch Name link (e.g., P2280 in this case) to get detailed settings.

Central Management >> Switch >> Alert and Log

| Alert Setup |                       | Switch and Port Setup |        | Alert Logs   |            |
|-------------|-----------------------|-----------------------|--------|--------------|------------|
| Index       | Switch Name           | IP                    | Model  | Switch Alert | Port Alert |
| 1           | <a href="#">P2280</a> | 192.168.1.11          | P2280x | Enable ▾     | Enable ▾   |

P2280 [\[Set to Factory Default\]](#)

Switch Alert

| Incident   | Level         |
|------------|---------------|
| Cold Start | Major Alert ▾ |
| Warm Start | Major Alert ▾ |
| Disconnect | Major Alert ▾ |
| Reconnect  | Minor Alert ▾ |

Port Alert

| Port | Description | Device Disconnects | Device Reconnects | Schedule on/off | Shutdown En/Dis |
|------|-------------|--------------------|-------------------|-----------------|-----------------|
| 1    |             | No Alert ▾         | No Alert ▾        | No Alert ▾      | No Alert ▾      |
| 2    | Uplink      | No Alert ▾         | No Alert ▾        | No Alert ▾      | No Alert ▾      |
| 3    |             | No Alert ▾         | No Alert ▾        | No Alert ▾      | No Alert ▾      |
| 4    |             | No Alert ▾         | No Alert ▾        | No Alert ▾      | No Alert ▾      |
| 5    |             | No Alert ▾         | No Alert ▾        | No Alert ▾      | No Alert ▾      |
| 6    |             | No Alert ▾         | No Alert ▾        | No Alert ▾      | No Alert ▾      |
| 7    |             | No Alert ▾         | No Alert ▾        | No Alert ▾      | No Alert ▾      |
| 8    |             | No Alert ▾         | No Alert ▾        | No Alert ▾      | No Alert ▾      |

Available settings are explained as follows:

| Item         | Description                                                                                                                                                                                                                                                                                                                                                |
|--------------|------------------------------------------------------------------------------------------------------------------------------------------------------------------------------------------------------------------------------------------------------------------------------------------------------------------------------------------------------------|
| Switch Alert | <p>When VigorSwitch encounters the following alert events, alert mechanism will perform corresponding actions based on the severity level of the incident encountered.</p> <p>Incident - At present, Cold Start, Warm Start, Disconnect and Reconnect will be treated as alert events.</p> <p>Level - Specify the severity level for each incident. To</p> |

|            |                                                                                                                                                                                                       |
|------------|-------------------------------------------------------------------------------------------------------------------------------------------------------------------------------------------------------|
|            | defined more severity level for choosing in this page, simply open Central Management>>Switch>>Alert and Log and click Alert Setup.                                                                   |
| Port Alert | Port - Available Ethernet ports for the selected VigorSwitch (e.g., G2280 in this case) will be shown on this page. Each port can be configured with different alert level for different alert event. |

### VII-7-5-3 Alert Logs

The user can get the information by filtering the collective information based on the conditions specified in this page.

Central Management >> Switch >> Alert and Log

---

**Alert Setup**   **Switch and Port Setup**   **Alert Logs**

Select Columns to Filter Logs

| Level                                   | Type                                  | Switch                                 |
|-----------------------------------------|---------------------------------------|----------------------------------------|
| <input type="checkbox"/> Minor Alert    | <input type="checkbox"/> Switch Alert | <input checked="" type="radio"/> P2280 |
| <input type="checkbox"/> Moderate Alert | <input type="checkbox"/> Port Alert   |                                        |
| <input type="checkbox"/> Major Alert    |                                       |                                        |

---

Alert Logs Show  per page | [Refresh](#) |

0 Logs   **Last 24 Hour**   Last 7 Days

| Index | Level Name | Time | Type | Switch | Port | Incident |
|-------|------------|------|------|--------|------|----------|
|-------|------------|------|------|--------|------|----------|

Available settings are explained as follows:

| Item                          | Description                                                                                                                                                                                                                                                                                                                                                                                                                                                                                             |
|-------------------------------|---------------------------------------------------------------------------------------------------------------------------------------------------------------------------------------------------------------------------------------------------------------------------------------------------------------------------------------------------------------------------------------------------------------------------------------------------------------------------------------------------------|
| Select Columns to Filter Logs | <p>Level - The alert can be divided into several levels, Minor Alert, Moderate Alert and Major Alert. Check the one(s) you want to check in Alert Logs list.</p> <p>Type - Check the type (switch / port) of the log to be displayed in Alert Logs list.</p> <p>Switch - Switch(es) connecting to Vigor router will be shown in this area. Click the one you need.</p> <p>OK - Click it to save the configuration.</p> <p>Log related to the items selected above will be shown in Alert Logs list.</p> |
| Alert Logs                    | This area displays logs (level name, time, type, switch, port, and incident) related to VigorSwitch managed by Vigor router.                                                                                                                                                                                                                                                                                                                                                                            |



## VII-7-6 Database Setup

The database of switch can be used to record alert logs and traffic history. This page is used to determine if it is necessary for the user information to be recorded in the database of switch.

Central Management >> Switch >> Database Setup

Enable Database to Record alert logs and traffic history

File Path : No USB Disk Detected

Database Usage : N/A

### Notification and Action when Storage Exceeded

Notification

Don't send notification

Send notification

Email Notification Object 1 - ???

SMS Notification Object 1 - ???

Action

Stop recording alert logs and traffic history

Backup and clean up all alert logs and traffic history, and start a new record

OK

**Note:**

In order to prevent data loss, we will start a new record at 45MB.

Available settings are explained as follows:

| Item                                                     | Description                                                                                                                                                                                                                                                             |
|----------------------------------------------------------|-------------------------------------------------------------------------------------------------------------------------------------------------------------------------------------------------------------------------------------------------------------------------|
| Enable Database to Record alert logs and traffic history | Check the box to make the database (in USB disk) record the alert logs and traffic history.                                                                                                                                                                             |
| <b>Notification and Action when Storage Exceeded</b>     |                                                                                                                                                                                                                                                                         |
| Notification                                             | <p>Don't send notification - No notification will be sent out when there is no capacity for storage in USB.</p> <p>Send notification - A notification will be sent out when there is no capacity for storage in USB.</p>                                                |
| Action                                                   | <p>Stop recording alert logs and traffic history - When the capacity of log is full, the system will stop recording.</p> <p>Backup and clean up all alert logs and traffic history, and start a new record - Only the newest events will be recorded by the system.</p> |

After finished the settings, click OK to save the configuration.

---

## VII-7-7 Support List

This page lists all models of VigorSwitch which can be managed by Vigor2927 via Central Management>>Switch.

Central Management >> Switch >> Support List

---

| Model                 | Status | Firmware Version |
|-----------------------|--------|------------------|
| Vigor Switch P2261    | V      | v3.48            |
| Vigor Switch G2260    | V      | v3.48            |
| Vigor Switch P1280    | V      | 2.2.1            |
| Vigor Switch G1280    | V      | 2.2.1            |
| Vigor Switch P2280    | V      | 2.2.1            |
| Vigor Switch G2280    | V      | 2.2.1            |
| Vigor Switch P2121    | V      | 2.3.2            |
| Vigor Switch G2121    | V      | 2.4.3            |
| Vigor Switch P1092    | V      | 1.04.05          |
| Vigor Switch G1080    | V      | 1.04.05          |
| Vigor Switch P2500    | V      | 2.4.1            |
| Vigor Switch G2500    | V      | 2.4.1            |
| Vigor Switch P2280x   | V      | 2.4.2            |
| Vigor Switch G2280x   | V      | 2.4.2            |
| Vigor Switch P1085    | V      | 2.4.3            |
| Vigor Switch G1085    | V      | 2.4.3            |
| Vigor Switch P2540x   | V      | 2.6.0            |
| Vigor Switch P2540xh  | V      | 2.6.0            |
| Vigor Switch G2540x   | V      | 2.6.0            |
| Vigor Switch P2100    | V      | 2.6.4            |
| Vigor Switch G2100    | V      | 2.6.4            |
| Vigor Switch PQ2200xb | V      | 2.6.9            |
| Vigor Switch Q2200x   | V      | 2.6.9            |
| Vigor Switch FX2120   | V      | 2.6.9            |
| Vigor Switch P1282    | V      | 2.6.9            |
| Vigor Switch G1282    | V      | 2.6.9            |

## VII-8 Central Management (External Devices)

Vigor router can be used to connect with many types of external devices. In order to control or manage the external devices conveniently, open External Devices to make detailed configuration.

Central Management >> External Device

- External Device Syslog
- External Device Auto Discovery
  - Enable Switch Management

External Devices Connected

| Refresh |

Below shows available devices that connected externally:

**For security reason:**

If you have changed the administrator password on External Device, please click the **Account** button to retype new username and password. Otherwise, the router will be unable to monitor the External Device device properly. Click the **Clear** button to Clear the off-line information and account information.

OK

Available settings are explained as follows:

| Item                           | Description                                                                          |
|--------------------------------|--------------------------------------------------------------------------------------|
| External Device Syslog         | Check this box to display information of the detected device on Syslog.              |
| External Device Auto Discovery | Check this box to detect the external device automatically and display on this page. |

From this web page, check the box of External Device Auto Discovery and click OK. Later, all the available devices will be displayed in this page with icons and corresponding information. You can change the device name if required or remove the information for off-line device whenever you want.

Central Management >> External Device

- External Device Syslog
- External Device Auto Discovery

External Devices Connected

| Refresh |

Below shows available devices that connected externally:

|         |                                                                                  |         |       |
|---------|----------------------------------------------------------------------------------|---------|-------|
| Offline | VigorAP903, VigorAP903, Connection Uptime:00:54:19<br>IP Address:192.168.1.12:80 | Account | Clear |
| On Line | VigorAP810, VigorAP810, Connection Uptime:00:47:09<br>IP Address:192.168.1.10:80 | Account | Clear |
| On Line | P2280x, P2280 Connection Uptime:00:25:09<br>IP Address:192.168.1.11:80           | Account | Clear |

**For security reason:**

If you have changed the administrator password on External Device, please click the **Account** button to retype new username and password. Otherwise, the router will be unable to monitor the External Device device properly. Click the **Clear** button to Clear the off-line information and account information.

OK

When you finished the configuration, click OK to save it.



---

Info

---

Only DrayTek products can be detected by this function.

---

# Part VIII Others



Objects Settings

Define objects such as IP address, service type, keyword, file extension and others. These pre-defined objects can be applied in CSM.



USB

USB device connected on Vigor router can be regarded as a server or WAN interface. By way of Vigor router, clients on LAN can access, write and read data stored in USB storage disk with different applications.

---

## VIII-1 Objects Settings

This section allows the creation of objects and object groups from IP addresses, service types, keywords, file extensions, SMS and email recipients, and notification types. Once set up, these objects can be applied to firewall and content management rules.

---

# Web User Interface

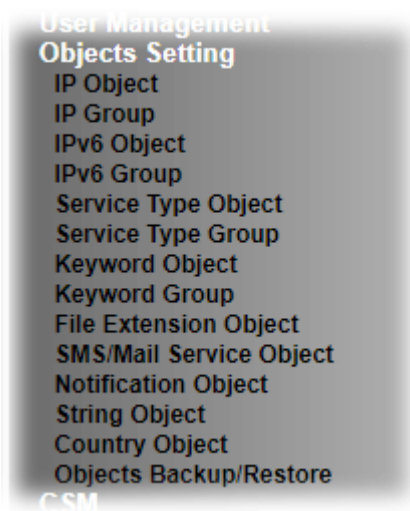

---

## VIII-1-1 IP Object

For IPs in a range and service ports in a limited range usually will be applied in configuring router's settings, therefore we can define them with *objects* and bind them with *groups* for using conveniently. Later, we can select that object/group for applying it. For example, all the IPs in the same department can be defined with an IP object (a range of IP address).

Up to 192 IP Objects can be created.

Objects Setting >> IP Object

[Create from ARP Table](#)  
[Create from Routing Table](#)

IP Object Profiles:

[Set to Factory Default](#)

View:

| Index               | Name | Address | Index               | Name | Address |
|---------------------|------|---------|---------------------|------|---------|
| <a href="#">1.</a>  |      |         | <a href="#">17.</a> |      |         |
| <a href="#">2.</a>  |      |         | <a href="#">18.</a> |      |         |
| <a href="#">3.</a>  |      |         | <a href="#">19.</a> |      |         |
| <a href="#">4.</a>  |      |         | <a href="#">20.</a> |      |         |
| <a href="#">5.</a>  |      |         | <a href="#">21.</a> |      |         |
| <a href="#">6.</a>  |      |         | <a href="#">22.</a> |      |         |
| <a href="#">7.</a>  |      |         | <a href="#">23.</a> |      |         |
| <a href="#">8.</a>  |      |         | <a href="#">24.</a> |      |         |
| <a href="#">9.</a>  |      |         | <a href="#">25.</a> |      |         |
| <a href="#">10.</a> |      |         | <a href="#">26.</a> |      |         |
| <a href="#">11.</a> |      |         | <a href="#">27.</a> |      |         |
| <a href="#">12.</a> |      |         | <a href="#">28.</a> |      |         |
| <a href="#">13.</a> |      |         | <a href="#">29.</a> |      |         |
| <a href="#">14.</a> |      |         | <a href="#">30.</a> |      |         |
| <a href="#">15.</a> |      |         | <a href="#">31.</a> |      |         |
| <a href="#">16.</a> |      |         | <a href="#">32.</a> |      |         |

<< [1-32](#) | [33-64](#) | [65-96](#) | [97-128](#) | [129-160](#) | [161-192](#) >>

[Next](#) >>

[Objects Backup/Restore](#)

Available settings are explained as follows:

| Item                   | Description                                                                                                                                                                   |
|------------------------|-------------------------------------------------------------------------------------------------------------------------------------------------------------------------------|
| View                   | Use the drop down list to choose a type (Single Address, Range Address, Subnet Address, Mac Address or all) that IP object with the selected type will be shown on this page. |
| Set to Factory Default | Clear all profile settings.                                                                                                                                                   |
| Search                 | Type a string of the IP object that you wan to search.                                                                                                                        |
| Index                  | Profile number of the IP object.                                                                                                                                              |
| Name                   | Name of the object.                                                                                                                                                           |
| Address                | Display the IP address configured for the object profile.                                                                                                                     |
| Objects Backup/Restore | Click it to backup or restore the IP object.                                                                                                                                  |

To set up a profile, click the profile number under Index column to bring up the configuration page.

Objects Setting >> IP Object

Profile Index : 1

|                   |                                                          |
|-------------------|----------------------------------------------------------|
| Name:             | <input type="text" value="RD Department"/>               |
| Interface:        | <input type="text" value="Any"/>                         |
| Address Type:     | <input type="text" value="Any Address"/>                 |
| Mac Address:      | <input type="text" value="00 : 00 : 00 : 00 : 00 : 00"/> |
| Start IP Address: | <input type="text" value="0.0.0.0"/>                     |
| End IP Address:   | <input type="text" value="0.0.0.0"/>                     |
| Subnet Mask:      | <input type="text" value="255.255.255.254 / 31"/>        |
| Invert Selection: | <input type="checkbox"/>                                 |

[Next >>](#)

Available settings are explained as follows:

| Item         | Description                                                                                                                                                                                                                                                                                                             |
|--------------|-------------------------------------------------------------------------------------------------------------------------------------------------------------------------------------------------------------------------------------------------------------------------------------------------------------------------|
| Name         | Name that identifies this profile. Maximum length is 15 characters.                                                                                                                                                                                                                                                     |
| Interface    | The network interface on which the IP address or addresses are to be found.<br>Any - All network interfaces.<br>LAN/DMZ/RT/VPN - All network interfaces except WAN.<br>WAN - Only WAN interfaces.                                                                                                                       |
| Address Type | Type of Addresses.<br>Any Address - Object covers all IP addresses.<br>Single Address - Object covers one IP address.<br>Range Address - Object covers a range of IP addresses.<br>Subnet Address - Object covers a range of IP addresses specified in subnet notation.<br>Mac Address - Object contains a MAC address. |
| MAC Address  | Enter MAC address of the network device, if Address Type is Mac Address.                                                                                                                                                                                                                                                |



|                  |                                                                                                         |
|------------------|---------------------------------------------------------------------------------------------------------|
| Start IP Address | Enter beginning IP address, if Address Type is one of Single Address, Range Address and Subnet Address. |
| End IP Address   | Enter ending IP address, if Address type is one of Single Address, Range Address and Subnet Address.    |
| Subnet Mask      | Enter subnet mask, if Address type is Subnet Mask.                                                      |
| Invert Selection | If selected, all addresses except the ones entered above will be used.                                  |

To save changes on the page, click OK. To discard changes, click Cancel. To blank out all settings in the current IP object, click Clear.

Objects Setting >> IP Object

[Create from ARP Table](#)

[Create from Routing Table](#)

IP Object Profiles:

View:

| Index     | Name          | Address           | Index      | Name |
|-----------|---------------|-------------------|------------|------|
| <u>1.</u> | RD Department | 0.0.0.0 ~ 0.0.0.0 | <u>17.</u> |      |
| <u>2.</u> |               |                   | <u>18.</u> |      |
| <u>3.</u> |               |                   | <u>19.</u> |      |

## VIII-1-2 IP Group

Multiple IP Objects can be placed into an IP Group.

Objects Setting >> IP Group

IP Group Table: [Set to Factory Default](#)

| Index      | Name | Index      | Name |
|------------|------|------------|------|
| <u>1.</u>  |      | <u>17.</u> |      |
| <u>2.</u>  |      | <u>18.</u> |      |
| <u>3.</u>  |      | <u>19.</u> |      |
| <u>4.</u>  |      | <u>20.</u> |      |
| <u>5.</u>  |      | <u>21.</u> |      |
| <u>6.</u>  |      | <u>22.</u> |      |
| <u>7.</u>  |      | <u>23.</u> |      |
| <u>8.</u>  |      | <u>24.</u> |      |
| <u>9.</u>  |      | <u>25.</u> |      |
| <u>10.</u> |      | <u>26.</u> |      |
| <u>11.</u> |      | <u>27.</u> |      |
| <u>12.</u> |      | <u>28.</u> |      |
| <u>13.</u> |      | <u>29.</u> |      |
| <u>14.</u> |      | <u>30.</u> |      |
| <u>15.</u> |      | <u>31.</u> |      |
| <u>16.</u> |      | <u>32.</u> |      |

[Objects Backup/Restore](#)

Available settings are explained as follows:

| Item                   | Description                                        |
|------------------------|----------------------------------------------------|
| Set to Factory Default | Clear all profile settings.                        |
| Index                  | Index number of the profile.                       |
| Name                   | Name that identifies the profile.                  |
| Objects Backup/Restore | Click it to backup or restore the IP group object. |

To set up a profile, click its index to bring up the configuration page.

Objects Setting >> IP Group

Profile Index : 1

Name:

Interface:

**Available IP Objects**

1-RD Department

>>

<<

**Selected IP Objects (Up to 12)**

Available settings are explained as follows:

| Item                 | Description                                                               |
|----------------------|---------------------------------------------------------------------------|
| Name                 | Name that identifies this profile. Maximum length is 15 characters.       |
| Interface            | Select WAN, LAN or Any to filter IP objects.                              |
| Available IP Objects | All available IP objects that are associated with the selected interface. |
| Selected IP Objects  | IP objects that have been added to this profile.                          |

To add an IP object to the IP Group, select it under Available IP Objects, then click the >> button. To remove an IP object from the IP Group, select it under Selected IP Objects, then click the << button.

To save changes on the page, click OK. To discard changes, click Cancel. To blank out all settings in the current IP group, click Clear.

## VIII-1-3 IPv6 Object

Up to 64 IPv6 Objects can be created.

Objects Setting >> IPv6 Object

IPv6 Object Profiles: [Set to Factory Default](#)

| Index               | Name | Index               | Name |
|---------------------|------|---------------------|------|
| <a href="#">1.</a>  |      | <a href="#">17.</a> |      |
| <a href="#">2.</a>  |      | <a href="#">18.</a> |      |
| <a href="#">3.</a>  |      | <a href="#">19.</a> |      |
| <a href="#">4.</a>  |      | <a href="#">20.</a> |      |
| <a href="#">5.</a>  |      | <a href="#">21.</a> |      |
| <a href="#">6.</a>  |      | <a href="#">22.</a> |      |
| <a href="#">7.</a>  |      | <a href="#">23.</a> |      |
| <a href="#">8.</a>  |      | <a href="#">24.</a> |      |
| <a href="#">9.</a>  |      | <a href="#">25.</a> |      |
| <a href="#">10.</a> |      | <a href="#">26.</a> |      |
| <a href="#">11.</a> |      | <a href="#">27.</a> |      |
| <a href="#">12.</a> |      | <a href="#">28.</a> |      |
| <a href="#">13.</a> |      | <a href="#">29.</a> |      |
| <a href="#">14.</a> |      | <a href="#">30.</a> |      |
| <a href="#">15.</a> |      | <a href="#">31.</a> |      |
| <a href="#">16.</a> |      | <a href="#">32.</a> |      |

<< [1-32](#) | [33-64](#) >> [Next](#) >>

[Objects Backup/Restore](#)

Available settings are explained as follows:

| Item                   | Description                                    |
|------------------------|------------------------------------------------|
| Set to Factory Default | Clear all profile settings.                    |
| Index                  | Index number of the profile.                   |
| Name                   | Name that identifies the profile.              |
| Objects Backup/Restore | Click it to backup or restore the IPv6 object. |

To set up a profile, click the profile number under Index column to bring up the configuration page.

Objects Setting >> IPv6 Object

Profile Index : 1

|                   |                                                                                              |
|-------------------|----------------------------------------------------------------------------------------------|
| Name:             | <input type="text" value="Financial Dept"/>                                                  |
| Address Type:     | <input type="text" value="Range Address"/>                                                   |
| Match Type:       | <input checked="" type="radio"/> 128 Bits <input type="radio"/> Suffix 64 Bits(Interface ID) |
| Mac Address:      | <input type="text" value="00 : 00 : 00 : 00 : 00 : 00"/>                                     |
| Start IP Address: | <input type="text"/> <input type="button" value="Select"/>                                   |
| End IP Address:   | <input type="text"/> <input type="button" value="Select"/>                                   |
| Prefix Length:    | <input type="text"/>                                                                         |
| Invert Selection: | <input type="checkbox"/>                                                                     |

[Next >>](#)

Available settings are explained as follows:

| Item             | Description                                                                                                                                                                                                                                                                                                                     |
|------------------|---------------------------------------------------------------------------------------------------------------------------------------------------------------------------------------------------------------------------------------------------------------------------------------------------------------------------------|
| Name             | Name that identifies this profile. Maximum length is 15 characters.                                                                                                                                                                                                                                                             |
| Address Type     | Type of Addresses.<br>Any Address - Object covers all IPv6 addresses.<br>Single Address - Object covers one IPv6 address.<br>Range Address - Object covers a range of IPv6 addresses.<br>Subnet Address - Object covers a range of IPv6 addresses specified in subnet notation.<br>Mac Address - Object contains a MAC address. |
| Match Type       | Specify the match type (128 Bits or Suffix 64 Bits) for the IPv6 address.                                                                                                                                                                                                                                                       |
| Mac Address      | Enter MAC address of the network device, if Address Type is Mac Address.                                                                                                                                                                                                                                                        |
| Start IP Address | Enter beginning IP address, if Address Type is one of Single Address, Range Address and Subnet Address.                                                                                                                                                                                                                         |
| End IP Address   | Enter ending IP address, if Address type is one of Single Address, Range Address and Subnet Address.                                                                                                                                                                                                                            |
| Prefix Length    | Enter IPv6 prefix length, if Address type is Subnet Address.                                                                                                                                                                                                                                                                    |
| Invert Selection | If selected, all addresses except the ones entered above will be used.                                                                                                                                                                                                                                                          |

To save changes on the page, click OK. To discard changes, click Cancel. To blank out all settings in the IPv6 object, click Clear.

## VIII-1-4 IPv6 Group

Multiple IPv6 Objects can be placed into an IPv6 Group.

Objects Setting >> IPv6 Group

IPv6 Group Table: | [Set to Factory Default](#) |

| Index               | Name | Index               | Name |
|---------------------|------|---------------------|------|
| <a href="#">1.</a>  |      | <a href="#">17.</a> |      |
| <a href="#">2.</a>  |      | <a href="#">18.</a> |      |
| <a href="#">3.</a>  |      | <a href="#">19.</a> |      |
| <a href="#">4.</a>  |      | <a href="#">20.</a> |      |
| <a href="#">5.</a>  |      | <a href="#">21.</a> |      |
| <a href="#">6.</a>  |      | <a href="#">22.</a> |      |
| <a href="#">7.</a>  |      | <a href="#">23.</a> |      |
| <a href="#">8.</a>  |      | <a href="#">24.</a> |      |
| <a href="#">9.</a>  |      | <a href="#">25.</a> |      |
| <a href="#">10.</a> |      | <a href="#">26.</a> |      |
| <a href="#">11.</a> |      | <a href="#">27.</a> |      |
| <a href="#">12.</a> |      | <a href="#">28.</a> |      |
| <a href="#">13.</a> |      | <a href="#">29.</a> |      |
| <a href="#">14.</a> |      | <a href="#">30.</a> |      |
| <a href="#">15.</a> |      | <a href="#">31.</a> |      |
| <a href="#">16.</a> |      | <a href="#">32.</a> |      |

[Objects Backup/Restore](#)

Available settings are explained as follows:

| Item                   | Description                                   |
|------------------------|-----------------------------------------------|
| Set to Factory Default | Clear all profile settings.                   |
| Index                  | Index number of the profile.                  |
| Name                   | Name that identifies the profile.             |
| Objects Backup/Restore | Click it to backup or restore the IPv6 group. |

To set up a profile, click the profile number under Index column to bring up the configuration page.

Objects Setting >> IPv6 Group

Profile Index : 1

Name:

Available IPv6 Objects

>>

<<

Selected IPv6 Objects (Up to 8)

Available settings are explained as follows:

| Item                   | Description                                                               |
|------------------------|---------------------------------------------------------------------------|
| Name                   | Name that identifies this profile. Maximum length is 15 characters.       |
| Available IPv6 Objects | All available IP objects that are associated with the selected interface. |
| Selected IPv6 Objects  | IPv6 objects that have been added to this profile.                        |

To add an IPv6 object to the IPv6 Group, select it under Available IPv6 Objects, then click the >> button. To remove an IPv6 object from the IPv6 Group, select it under Selected IPv6 Objects, then click the << button.

To save changes on the page, click OK. To discard changes, click Cancel. To blank out all settings in the current IPv6 group, click Clear.

---

## VIII-1-5 Service Type Object

Up to 96 Service Type Objects can be created.

Objects Setting >> Service Type Object

Service Type Object Profiles:

| [Set to Factory Default](#) |

| Index               | Name | Index               | Name |
|---------------------|------|---------------------|------|
| <a href="#">1.</a>  |      | <a href="#">17.</a> |      |
| <a href="#">2.</a>  |      | <a href="#">18.</a> |      |
| <a href="#">3.</a>  |      | <a href="#">19.</a> |      |
| <a href="#">4.</a>  |      | <a href="#">20.</a> |      |
| <a href="#">5.</a>  |      | <a href="#">21.</a> |      |
| <a href="#">6.</a>  |      | <a href="#">22.</a> |      |
| <a href="#">7.</a>  |      | <a href="#">23.</a> |      |
| <a href="#">8.</a>  |      | <a href="#">24.</a> |      |
| <a href="#">9.</a>  |      | <a href="#">25.</a> |      |
| <a href="#">10.</a> |      | <a href="#">26.</a> |      |
| <a href="#">11.</a> |      | <a href="#">27.</a> |      |
| <a href="#">12.</a> |      | <a href="#">28.</a> |      |
| <a href="#">13.</a> |      | <a href="#">29.</a> |      |
| <a href="#">14.</a> |      | <a href="#">30.</a> |      |
| <a href="#">15.</a> |      | <a href="#">31.</a> |      |
| <a href="#">16.</a> |      | <a href="#">32.</a> |      |

<< [1-32](#) | [33-64](#) | [65-96](#) >>

[Next](#) >>

[Objects Backup/Restore](#)

Available settings are explained as follows:

| Item                   | Description                                            |
|------------------------|--------------------------------------------------------|
| Set to Factory Default | Clear all profile settings.                            |
| Index                  | Index number of the profile.                           |
| Name                   | Name that identifies the profile.                      |
| Objects Backup/Restore | Click it to backup or restore the service type object. |



To set up a profile, click the profile number under Index column to bring up the configuration page.

Objects Setting >> Service Type Object Setup

Profile Index : 1

|                  |                                                                       |
|------------------|-----------------------------------------------------------------------|
| Name             | <input type="text" value="www"/>                                      |
| Protocol         | TCP <input type="text" value="6"/>                                    |
| Source Port      | = <input type="text" value="1"/> ~ <input type="text" value="65535"/> |
| Destination Port | = <input type="text" value="1"/> ~ <input type="text" value="65535"/> |

[Next >>](#)

Available settings are explained as follows:

| Item                    | Description                                                                                                                                                                                                                                                                                                                                                                                 |
|-------------------------|---------------------------------------------------------------------------------------------------------------------------------------------------------------------------------------------------------------------------------------------------------------------------------------------------------------------------------------------------------------------------------------------|
| Name                    | Name that identifies this profile. Maximum length is 15 characters.                                                                                                                                                                                                                                                                                                                         |
| Protocol                | Protocol(s) to which this profile applies.<br>Any - All protocols.<br>ICMP - Internet Control Message Protocol<br>IGMP - Internet Group Management Protocol<br>TCP - Transmission Control Protocol<br>UDP - User Datagram Protocol<br>TCP/UDP - Transmission Control Protocol and User Datagram Protocol<br>Other - Other protocols not listed above. Enter protocol number in the textbox. |
| Source/Destination Port | When protocol selected includes TCP or UDP, the source and destination ports can be specified.<br>= - any port that falls within the specified range.<br>!= - any port that falls outside of the specified range.<br>- all port numbers that are greater than the specified value.<br>< - all port numbers that are smaller than the specified value.                                       |

To save changes on the page, click OK. To discard changes, click Cancel. To blank out all settings in the current service type object, click Clear.

Objects Setting >> Service Type Object

Service Type Object Profiles:

| Index              | Name | Index               |
|--------------------|------|---------------------|
| <a href="#">1.</a> | www  | <a href="#">17.</a> |
| <a href="#">2.</a> | SIP  | <a href="#">18.</a> |
| <a href="#">3.</a> |      | <a href="#">19.</a> |
| <a href="#">4.</a> |      | 20                  |

---

## VIII-1-6 Service Type Group

Multiple Service Type Objects can be placed into a Service Type Group.

Objects Setting >> Service Type Group

Service Type Group Table:

| [Set to Factory Default](#) |

| Group               | Name | Group               | Name |
|---------------------|------|---------------------|------|
| <a href="#">1.</a>  |      | <a href="#">17.</a> |      |
| <a href="#">2.</a>  |      | <a href="#">18.</a> |      |
| <a href="#">3.</a>  |      | <a href="#">19.</a> |      |
| <a href="#">4.</a>  |      | <a href="#">20.</a> |      |
| <a href="#">5.</a>  |      | <a href="#">21.</a> |      |
| <a href="#">6.</a>  |      | <a href="#">22.</a> |      |
| <a href="#">7.</a>  |      | <a href="#">23.</a> |      |
| <a href="#">8.</a>  |      | <a href="#">24.</a> |      |
| <a href="#">9.</a>  |      | <a href="#">25.</a> |      |
| <a href="#">10.</a> |      | <a href="#">26.</a> |      |
| <a href="#">11.</a> |      | <a href="#">27.</a> |      |
| <a href="#">12.</a> |      | <a href="#">28.</a> |      |
| <a href="#">13.</a> |      | <a href="#">29.</a> |      |
| <a href="#">14.</a> |      | <a href="#">30.</a> |      |
| <a href="#">15.</a> |      | <a href="#">31.</a> |      |
| <a href="#">16.</a> |      | <a href="#">32.</a> |      |

[Objects Backup/Restore](#)

Available settings are explained as follows:

| Item                   | Description                                                  |
|------------------------|--------------------------------------------------------------|
| Set to Factory Default | Clear all profile settings.                                  |
| Index                  | Index number of the profile.                                 |
| Name                   | Name that identifies the profile.                            |
| Objects Backup/Restore | Click it to backup or restore the service type group object. |

To set up a profile, click the profile number under Index column to bring up the configuration page.

Objects Setting >> Service Type Group Setup

Profile Index : 1

Name:

**Available Service Type Objects**

>>

<<

**Selected Service Type Objects (Up to 8)**

OK    Clear    Cancel

Available settings are explained as follows:

| Item                           | Description                                                         |
|--------------------------------|---------------------------------------------------------------------|
| Name                           | Name that identifies this profile. Maximum length is 15 characters. |
| Available Service Type Objects | All available service type objects.                                 |
| Selected Service Type Objects  | Service type objects that have been added to this profile.          |

To add a Service Type Object to the Service Type Group, select it under Available Service Type Objects, then click the >> button. To remove a Service Type Object to the Service Type Group, select it under Selected Service Type Objects, then click the << button.

To save changes on the page, click OK. To discard changes, click Cancel. To blank out all settings in the current service type group, click Clear.

## VIII-1-7 Keyword Object

200 Keyword Object Profiles can be created for use as blacklists or white lists in CSM >>URL Content Filter Profile and Web Content Filter Profile.

Objects Setting >> Keyword Object

Keyword Object Profiles: | [Set to Factory Default](#) |

| Index               | Name | Index               | Name |
|---------------------|------|---------------------|------|
| <a href="#">1.</a>  |      | <a href="#">17.</a> |      |
| <a href="#">2.</a>  |      | <a href="#">18.</a> |      |
| <a href="#">3.</a>  |      | <a href="#">19.</a> |      |
| <a href="#">4.</a>  |      | <a href="#">20.</a> |      |
| <a href="#">5.</a>  |      | <a href="#">21.</a> |      |
| <a href="#">6.</a>  |      | <a href="#">22.</a> |      |
| <a href="#">7.</a>  |      | <a href="#">23.</a> |      |
| <a href="#">8.</a>  |      | <a href="#">24.</a> |      |
| <a href="#">9.</a>  |      | <a href="#">25.</a> |      |
| <a href="#">10.</a> |      | <a href="#">26.</a> |      |
| <a href="#">11.</a> |      | <a href="#">27.</a> |      |
| <a href="#">12.</a> |      | <a href="#">28.</a> |      |
| <a href="#">13.</a> |      | <a href="#">29.</a> |      |
| <a href="#">14.</a> |      | <a href="#">30.</a> |      |
| <a href="#">15.</a> |      | <a href="#">31.</a> |      |
| <a href="#">16.</a> |      | <a href="#">32.</a> |      |

<< [1-32](#) | [33-64](#) | [65-96](#) | [97-128](#) | [129-160](#) | [161-192](#) | [193-200](#) >> [Next](#) >>

[Objects Backup/Restore](#)

Available settings are explained as follows:

| Item                   | Description                                       |
|------------------------|---------------------------------------------------|
| Set to Factory Default | Clear all profile settings.                       |
| Index                  | Index number of the profile.                      |
| Name                   | Name that identifies the profile.                 |
| Objects Backup/Restore | Click it to backup or restore the keyword object. |

To set up a profile, click its index to bring up the configuration page.

Objects Setting >> Keyword Object Setup

Profile Index : 1

|          |                      |
|----------|----------------------|
| Name     | <input type="text"/> |
| Contents | <input type="text"/> |

**Limit of Contents:** Max 3 Words and 63 Characters.  
Each word should be separated by a single space.

You can replace a character with %HEX.  
Example:  
Contents: backdoo%72 virus keep%20out

Result:  
1. backdoor  
2. virus  
3. keep out

Available settings are explained as follows:

| Item     | Description                                                                                                                                                                                                                                                           |
|----------|-----------------------------------------------------------------------------------------------------------------------------------------------------------------------------------------------------------------------------------------------------------------------|
| Name     | Name that identifies this profile. Maximum length is 15 characters.                                                                                                                                                                                                   |
| Contents | Keywords to be matched. Up to 3 key phrases, separated by spaces, for a total length of 63 characters can be entered. For key phrases that contain spaces, replace spaces with the sequence %20. For example, the phrase “keep out” is to be entered as “keep%20out”. |

To save changes on the page, click OK. To discard changes, click Cancel. To blank out all settings in the current keyword object, click Clear.

## VIII-1-8 Keyword Group

Multiple Keyword Objects can be placed into a Keyword Group.

Keyword groups can be chosen as blacklists or white lists in CSM >>URL /Web Content Filter Profile.

Objects Setting >> Keyword Group

Keyword Group Table: | [Set to Factory Default](#) |

| Index               | Name | Objects | Index               | Name | Objects |
|---------------------|------|---------|---------------------|------|---------|
| <a href="#">1.</a>  |      |         | <a href="#">17.</a> |      |         |
| <a href="#">2.</a>  |      |         | <a href="#">18.</a> |      |         |
| <a href="#">3.</a>  |      |         | <a href="#">19.</a> |      |         |
| <a href="#">4.</a>  |      |         | <a href="#">20.</a> |      |         |
| <a href="#">5.</a>  |      |         | <a href="#">21.</a> |      |         |
| <a href="#">6.</a>  |      |         | <a href="#">22.</a> |      |         |
| <a href="#">7.</a>  |      |         | <a href="#">23.</a> |      |         |
| <a href="#">8.</a>  |      |         | <a href="#">24.</a> |      |         |
| <a href="#">9.</a>  |      |         | <a href="#">25.</a> |      |         |
| <a href="#">10.</a> |      |         | <a href="#">26.</a> |      |         |
| <a href="#">11.</a> |      |         | <a href="#">27.</a> |      |         |
| <a href="#">12.</a> |      |         | <a href="#">28.</a> |      |         |
| <a href="#">13.</a> |      |         | <a href="#">29.</a> |      |         |
| <a href="#">14.</a> |      |         | <a href="#">30.</a> |      |         |
| <a href="#">15.</a> |      |         | <a href="#">31.</a> |      |         |
| <a href="#">16.</a> |      |         | <a href="#">32.</a> |      |         |

[Objects Backup/Restore](#)

Available settings are explained as follows:

| Item                   | Description                                      |
|------------------------|--------------------------------------------------|
| Set to Factory Default | Clear all profile settings.                      |
| Index                  | Index number of the profile.                     |
| Name                   | Name that identifies the profile.                |
| Objects                | Display the keyword objects under this group.    |
| Objects Backup/Restore | Click it to backup or restore the keyword group. |

To set up a profile, click its index to bring up the configuration page.

Objects Setting >> Keyword Group Setup

Profile Index : 1

Name:

Available Keyword Objects

>>

<<

Selected Keyword Objects (Up to 16)

Available settings are explained as follows:

| Item                      | Description                                                         |
|---------------------------|---------------------------------------------------------------------|
| Name                      | Name that identifies this profile. Maximum length is 15 characters. |
| Available Keyword Objects | All keyword objects that have not been added to this profile.       |
| Selected Keyword Objects  | Keyword objects that have been added to this profile.               |

To add a Service Type Object to the Service Type Group, select it under Available Service Type Objects, then click the >> button. To remove a Service Type Object to the Service Type Group, select it under Selected Service Type Objects, then click the << button.

To save changes on the page, click OK. To discard changes, click Cancel. To blank out all settings in the current keyword group, click Clear.

## VIII-1-9 File Extension Object

Up to 8 File Extension Objects can be set up for use with CSM>>URL Content Filter.

Objects Setting >> File Extension Object

File Extension Object Profiles: | [Set to Factory Default](#) |

| Profile   | Name | Profile   | Name |
|-----------|------|-----------|------|
| <u>1.</u> |      | <u>5.</u> |      |
| <u>2.</u> |      | <u>6.</u> |      |
| <u>3.</u> |      | <u>7.</u> |      |
| <u>4.</u> |      | <u>8.</u> |      |

[Objects Backup/Restore](#)

Available settings are explained as follows:

| Item                   | Description                                              |
|------------------------|----------------------------------------------------------|
| Set to Factory Default | Clear all profile settings.                              |
| Index                  | Index number of the profile.                             |
| Name                   | Name that identifies the profile.                        |
| Objects Backup/Restore | Click it to backup or restore the file extension object. |

To set up a profile, click its index to bring up the configuration page.

Objects Setting >> File Extension Object Setup

Profile Index: 1      Profile Name:

| Categories                                                                                                  | File Extensions                                                                                                                                                                                                                                                                                                                                                                                                                                                                                                                       |
|-------------------------------------------------------------------------------------------------------------|---------------------------------------------------------------------------------------------------------------------------------------------------------------------------------------------------------------------------------------------------------------------------------------------------------------------------------------------------------------------------------------------------------------------------------------------------------------------------------------------------------------------------------------|
| <b>Image</b><br><input type="button" value="Select All"/><br><input type="button" value="Clear All"/>       | <input type="checkbox"/> .bmp <input type="checkbox"/> .dib <input type="checkbox"/> .gif <input type="checkbox"/> .jpeg <input type="checkbox"/> .jpg <input type="checkbox"/> .jpg2 <input type="checkbox"/> .jp2<br><input type="checkbox"/> .pct <input type="checkbox"/> .pcx <input type="checkbox"/> .pic <input type="checkbox"/> .pict <input type="checkbox"/> .png <input type="checkbox"/> .tif <input type="checkbox"/> .tiff<br><input type="checkbox"/> .ico                                                           |
| <b>Video</b><br><input type="button" value="Select All"/><br><input type="button" value="Clear All"/>       | <input type="checkbox"/> .asf <input type="checkbox"/> .avi <input type="checkbox"/> .mov <input type="checkbox"/> .mpe <input type="checkbox"/> .mpeg <input type="checkbox"/> .mpg <input type="checkbox"/> .mp4<br><input type="checkbox"/> .qt <input type="checkbox"/> .rm <input type="checkbox"/> .wmv <input type="checkbox"/> .3gp <input type="checkbox"/> .3gpp <input type="checkbox"/> .3gpp2 <input type="checkbox"/> .3g2<br><input type="checkbox"/> .flv <input type="checkbox"/> .swf <input type="checkbox"/> .mkv |
| <b>Audio</b><br><input type="button" value="Select All"/><br><input type="button" value="Clear All"/>       | <input type="checkbox"/> .aac <input type="checkbox"/> .aiff <input type="checkbox"/> .au <input type="checkbox"/> .mp3 <input type="checkbox"/> .m4a <input type="checkbox"/> .m4p <input type="checkbox"/> .ogg<br><input type="checkbox"/> .ra <input type="checkbox"/> .ram <input type="checkbox"/> .vox <input type="checkbox"/> .wav <input type="checkbox"/> .wma                                                                                                                                                             |
| <b>Java</b><br><input type="button" value="Select All"/><br><input type="button" value="Clear All"/>        | <input type="checkbox"/> .class <input type="checkbox"/> .jad <input type="checkbox"/> .jar <input type="checkbox"/> .jav <input type="checkbox"/> .java <input type="checkbox"/> .jcm <input type="checkbox"/> .js<br><input type="checkbox"/> .jse <input type="checkbox"/> .jsp <input type="checkbox"/> .jtk                                                                                                                                                                                                                      |
| <b>ActiveX</b><br><input type="button" value="Select All"/><br><input type="button" value="Clear All"/>     | <input type="checkbox"/> .alx <input type="checkbox"/> .apb <input type="checkbox"/> .axs <input type="checkbox"/> .ocx <input type="checkbox"/> .olb <input type="checkbox"/> .ole <input type="checkbox"/> .tlb<br><input type="checkbox"/> .viv <input type="checkbox"/> .vrm                                                                                                                                                                                                                                                      |
| <b>Compression</b><br><input type="button" value="Select All"/><br><input type="button" value="Clear All"/> | <input type="checkbox"/> .ace <input type="checkbox"/> .arj <input type="checkbox"/> .bzip2 <input type="checkbox"/> .bz2 <input type="checkbox"/> .cab <input type="checkbox"/> .gz <input type="checkbox"/> .gzip<br><input type="checkbox"/> .rar <input type="checkbox"/> .sit <input type="checkbox"/> .zip <input type="checkbox"/> .7z <input type="checkbox"/> .tar.gz <input type="checkbox"/> .dmg <input type="checkbox"/> .apk<br><input type="checkbox"/> .iso <input type="checkbox"/> .img                             |
| <b>Execution</b><br><input type="button" value="Select All"/><br><input type="button" value="Clear All"/>   | <input type="checkbox"/> .bas <input type="checkbox"/> .bat <input type="checkbox"/> .com <input type="checkbox"/> .exe <input type="checkbox"/> .inf <input type="checkbox"/> .pif <input type="checkbox"/> .reg<br><input type="checkbox"/> .scr                                                                                                                                                                                                                                                                                    |
| <b>P2P</b><br><input type="button" value="Select All"/><br><input type="button" value="Clear All"/>         | <input type="checkbox"/> .torrent                                                                                                                                                                                                                                                                                                                                                                                                                                                                                                     |
| <b>Document</b><br><input type="button" value="Select All"/><br><input type="button" value="Clear All"/>    | <input type="checkbox"/> .doc <input type="checkbox"/> .docx <input type="checkbox"/> .odp <input type="checkbox"/> .ods <input type="checkbox"/> .odt <input type="checkbox"/> .pdf <input type="checkbox"/> .ppt<br><input type="checkbox"/> .pptx <input type="checkbox"/> .xls <input type="checkbox"/> .xlsx                                                                                                                                                                                                                     |

Available settings are explained as follows:

| Item         | Description                                                        |
|--------------|--------------------------------------------------------------------|
| Profile Name | Name that identifies this profile. Maximum length is 7 characters. |
| Select All   | Selects all file extensions for the category.                      |
| Clear All    | Deselects all file extensions for the category.                    |

Select the file extensions you wish to be included in the profile. To save changes on the page, click OK. To discard changes, click Cancel. To blank out all settings in the current file extension object, click Clear.



---

## VIII-1-10 SMS/Mail Service Object

### SMS Service Object

Up to 10 SMS Service Objects can be set up for use with Application>>SMS Alert Service.

Objects Setting >> SMS / Mail Service Object

| SMS Provider | Mail Server  | <a href="#">Set to Factory Default</a> |
|--------------|--------------|----------------------------------------|
| Index        | Profile Name | SMS Provider                           |
| 1.           |              |                                        |
| 2.           |              |                                        |
| 3.           |              |                                        |
| 4.           |              |                                        |
| 5.           |              |                                        |
| 6.           |              |                                        |
| 7.           |              |                                        |
| 8.           |              |                                        |
| 9.           | Custom 1     |                                        |
| 10.          | Custom 2     |                                        |

#### Objects Backup/Restore

Each item is explained as follows:

| Item                   | Description                                       |
|------------------------|---------------------------------------------------|
| Set to Factory Default | Clear all profile settings.                       |
| Index                  | Index number of the profile.                      |
| Profile Name           | Name that identifies the profile.                 |
| SMS Provider           | The SMS provider selected for the profile.        |
| Objects Backup/Restore | Click it to backup or restore the service object. |

To set up a profile, click the SMS Provider tab, and then click its index to bring up the configuration page.

Object Settings >> SMS / Mail Service Object

| SMS Provider | Mail Server         |
|--------------|---------------------|
| <b>Index</b> | <b>Profile Name</b> |
| 1.           |                     |
| 2.           |                     |
| 3.           |                     |
| 4.           |                     |



Objects Setting >> SMS / Mail Service Object

Profile Index: 1

|                     |                                                                   |
|---------------------|-------------------------------------------------------------------|
| Profile Name        | <input type="text"/>                                              |
| Service Provider    | kotsms.com.tw (TW) ▼                                              |
| Connection Protocol | <input checked="" type="radio"/> HTTP <input type="radio"/> HTTPS |
| Username            | <input type="text"/> Max: 31 characters                           |
| Password            | <input type="text"/> Max: 31 characters                           |
| Quota               | <input type="text"/> 10                                           |
| Sending Interval    | <input type="text"/> 3 (seconds)                                  |

Note:

1. Only one message can be sent during the "Sending Interval" time.
2. If the "Sending Interval" was set to 0, there will be no limitation.

Available settings are explained as follows:

| Item                | Description                                                                                                                                                                                                       |
|---------------------|-------------------------------------------------------------------------------------------------------------------------------------------------------------------------------------------------------------------|
| Profile Name        | Name that identifies this profile. Maximum length is 31 characters.                                                                                                                                               |
| Service Provider    | Select a Service Provider from the dropdown list.                                                                                                                                                                 |
| Connection Protocol | Specify HTTP or HTTPS.                                                                                                                                                                                            |
| Username            | Username used to log in to the service. Maximum length is 31 characters.                                                                                                                                          |
| Password            | Password used to log in to the service. Maximum length is 31 characters.                                                                                                                                          |
| Quota               | Remaining number of text messages allowed to be sent. The quota value reduces by 1 every time the router sends an SMS message. When the quota reaches 0, no SMS will be sent until it is reset to greater than 0. |
| Sending Interval    | Minimum amount of time, in seconds, to wait between sending SMS messages.                                                                                                                                         |
| Send a Test Message | Click it to send a test e-mail according to above configuration.                                                                                                                                                  |

To save changes on the page, click OK. To discard changes, click Cancel. To blank out all settings in the SMS service object, click Clear.

| SMS Provider |              | Mail Server        | Set to Factory Default |
|--------------|--------------|--------------------|------------------------|
| Index        | Profile Name | SMS Provider       |                        |
| 1.           | Line_down    | kotsms.com.tw (TW) |                        |
| 2.           |              |                    |                        |
| 3.           |              |                    |                        |
| 4.           |              |                    |                        |
| 5.           |              |                    |                        |
| 6.           |              |                    |                        |
| 7.           |              |                    |                        |
| 8.           |              |                    |                        |

### Customized SMS Service

The router offers an extensive list of preset SMS service providers for your convenience. However, if your service provider is not among the list of supported service providers, simply use Indexes 9 and 10 to create a customized SMS service profile.

| SMS Provider |              | Mail Server  | Set to Factory Default |
|--------------|--------------|--------------|------------------------|
| Index        | Profile Name | SMS Provider |                        |
| 1.           |              |              |                        |
| 2.           |              |              |                        |
| 3.           |              |              |                        |
| 4.           |              |              |                        |
| 5.           |              |              |                        |
| 6.           |              |              |                        |
| 7.           |              |              |                        |
| 8.           |              |              |                        |
| 9.           | Custom 1     |              |                        |
| 10.          | Custom 2     |              |                        |

To set up a customized profile, click the SMS Provider tab, and then click one of the 2 indexes (9 and 10) to bring up the configuration page.

#### Profile Index: 9

|                                                                                                                                                                                                                                                                               |                                                  |
|-------------------------------------------------------------------------------------------------------------------------------------------------------------------------------------------------------------------------------------------------------------------------------|--------------------------------------------------|
| Profile Name                                                                                                                                                                                                                                                                  | <input type="text" value="Custom 1"/>            |
| Service Provider                                                                                                                                                                                                                                                              | <input type="text"/>                             |
| Max: 255 characters                                                                                                                                                                                                                                                           |                                                  |
| <p>Please contact with your SMS provide to get the exact URL String<br/>                 eg:bulksms.vsms.net:5567/eapi/submission/send_sms/2/2.0?username=###txtUser###<br/>                 &amp;password=###txtPwd###&amp;msisdn=###txtDest###&amp;message=###txtMsg###</p> |                                                  |
| Server Response                                                                                                                                                                                                                                                               | <input type="text" value="Max: 31 characters"/>  |
| Username                                                                                                                                                                                                                                                                      | <input type="text" value="Max: 128 characters"/> |
| Password                                                                                                                                                                                                                                                                      | <input type="text" value="Max: 128 characters"/> |
| SMS Quota                                                                                                                                                                                                                                                                     | <input type="text" value="10"/>                  |
| Sending Interval                                                                                                                                                                                                                                                              | <input type="text" value="3"/> (seconds)         |

**Note:**

1. Only one message can be sent during the "Sending Interval" time.
2. If the "Sending Interval" was set to 0, there will be no limitation.

Available settings are explained as follows:

| Item             | Description                                                                                                                                                                                                       |
|------------------|-------------------------------------------------------------------------------------------------------------------------------------------------------------------------------------------------------------------|
| Profile Name     | Display-only profile name, which is Custom 1 for Index 9 and Custom 2 for Index 10.                                                                                                                               |
| Service Provider | Enter an identifier for the service provider. Maximum length is 23 characters.                                                                                                                                    |
| Entry box        | Enter the URL for the SMS service. Maximum length is 255 characters. Contact the service provider for the appropriate URL to use.                                                                                 |
| Server Response  | Enter the API text defined by the SMS provider. It allows Vigor router to acknowledge that the SMS server has received the request coming from the SMS server.                                                    |
| Username         | Username used to log in to the service. Maximum length is 31 characters.                                                                                                                                          |
| Password         | Password used to log in to the service. Maximum length is 31 characters.                                                                                                                                          |
| Quota            | Remaining number of text messages allowed to be sent. The quota value reduces by 1 every time the router sends an SMS message. When the quota reaches 0, no SMS will be sent until it is reset to greater than 0. |
| Sending Interval | Minimum amount of time, in seconds, to wait between sending SMS messages.                                                                                                                                         |

To save changes on the page, click OK. To discard changes, click Cancel. To blank out all settings in the SMS service object, click Clear.

### Mail Service Object

Up to 10 Mail Service Objects can be set up for use with Application>>Mail Alert Service.

Objects Setting >> SMS / Mail Service Object

| SMS Provider |              | Mail Server | <a href="#">Set to Factory Default</a> |
|--------------|--------------|-------------|----------------------------------------|
| Index        | Profile Name |             |                                        |
| 1.           |              |             |                                        |
| 2.           |              |             |                                        |
| 3.           |              |             |                                        |
| 4.           |              |             |                                        |
| 5.           |              |             |                                        |
| 6.           |              |             |                                        |
| 7.           |              |             |                                        |
| 8.           |              |             |                                        |
| 9.           |              |             |                                        |
| 10.          |              |             |                                        |

[Objects Backup/Restore](#)

Each item is explained as follows:

| Item                   | Description                  |
|------------------------|------------------------------|
| Set to Factory Default | Clear all profile settings.  |
| Index                  | Index number of the profile. |

|                        |                                                   |
|------------------------|---------------------------------------------------|
| Profile Name           | Name that identifies the profile.                 |
| Objects Backup/Restore | Click it to backup or restore the service object. |

To set up a profile, click the Mail Server tab, and then click its index to bring up the configuration page.

Objects Setting >> SMS / Mail Service Object

Profile Index: 1

|                                                    |                                                  |
|----------------------------------------------------|--------------------------------------------------|
| Profile Name                                       | <input type="text" value="Mail_Notify"/>         |
| Interface                                          | <input type="text" value="Any"/>                 |
| SMTP Server                                        | <input type="text" value="192.168.1.98"/>        |
| SMTP Port                                          | <input type="text" value="465"/>                 |
| Sender Address                                     | <input type="text" value="carrie_@draytek.com"/> |
| Connection Security                                | <input type="text" value="SSL"/>                 |
| <input checked="" type="checkbox"/> Authentication |                                                  |
| Username                                           | <input type="text" value="john"/>                |
| Password                                           | <input type="text" value="....."/>               |
| Sending Interval                                   | <input type="text" value="0"/> (seconds)         |

Note:

1. Only one mail can be sent during the "Sending Interval" time.
2. If the "Sending Interval" was set to 0, there will be no limitation.

Available settings are explained as follows:

| Item                | Description                                                                                                                                                                                                                     |
|---------------------|---------------------------------------------------------------------------------------------------------------------------------------------------------------------------------------------------------------------------------|
| Profile Name        | Name that identifies this profile. Maximum length is 31 characters.                                                                                                                                                             |
| Interface           | Select an interface for mail passing through.                                                                                                                                                                                   |
| SMTP Server         | IP address of the SMTP server.                                                                                                                                                                                                  |
| SMTP Port           | Port number of the SMTP server.                                                                                                                                                                                                 |
| Sender Address      | E-mail address of the sender.                                                                                                                                                                                                   |
| Connection Security | Use Plaintext, StartTLS or SSL to communicate with the SMTP server.                                                                                                                                                             |
| Authentication      | Select to send username and password to SMTP server for authentication.<br>Username - Username for authentication. Maximum length is 31 characters.<br>Password - Password for authentication. Maximum length is 31 characters. |
| Sending Interval    | Minimum amount of time, in seconds, to wait between sending e-mail messages.                                                                                                                                                    |
| Send a Test E-mail  | Click it to send a test e-mail according to above configuration.                                                                                                                                                                |

To save changes on the page, click OK. To discard changes, click Cancel. To blank out all settings in the mail service object, click Clear.

## VIII-1-11 Notification Object

Up to 8 Notification Objects can be set up for use in Application>>SMS Alert Service and Application>>Mail Alert Service.

Objects Setting >> Notification Object

| <a href="#">Set to Factory Default</a> |              |          |
|----------------------------------------|--------------|----------|
| Index                                  | Profile Name | Settings |
| 1.                                     |              |          |
| 2.                                     |              |          |
| 3.                                     |              |          |
| 4.                                     |              |          |
| 5.                                     |              |          |
| 6.                                     |              |          |
| 7.                                     |              |          |
| 8.                                     |              |          |

[Objects Backup/Restore](#)

To set up a profile, click its index to bring up the configuration page.

Objects Setting >> Notification Object

Profile Index: 1

| Profile Name           |                                                                                                                                                                                                                                                                                                                             | <input type="text"/>                 |
|------------------------|-----------------------------------------------------------------------------------------------------------------------------------------------------------------------------------------------------------------------------------------------------------------------------------------------------------------------------|--------------------------------------|
| Category               | Status                                                                                                                                                                                                                                                                                                                      |                                      |
| WAN                    | <input type="checkbox"/> Disconnected                                                                                                                                                                                                                                                                                       | <input type="checkbox"/> Reconnected |
|                        | <input type="checkbox"/> Disconnected                                                                                                                                                                                                                                                                                       | <input type="checkbox"/> Reconnected |
| VPN Tunnel             | <input type="checkbox"/> Downtime Limit                                                                                                                                                                                                                                                                                     |                                      |
|                        | <input type="text" value="60~3600"/> seconds                                                                                                                                                                                                                                                                                |                                      |
| Temperature Alert      | <input type="checkbox"/> USB Out of Range                                                                                                                                                                                                                                                                                   |                                      |
| WAN Budget             | <input type="checkbox"/> Limit Reached                                                                                                                                                                                                                                                                                      |                                      |
| Central VPN Management | <input type="checkbox"/> CPE Offline<br><input type="checkbox"/> CPE Config Backup Fail<br><input type="checkbox"/> CPE Config Restore Fail<br><input type="checkbox"/> CPE Firmware Upgrade Fail<br><input type="checkbox"/> CPE VPN Profile Setup Fail                                                                    |                                      |
| High Availability      | <input type="checkbox"/> Failover Occurred<br><input type="checkbox"/> Config Sync Fail<br><input type="checkbox"/> Router Unstable                                                                                                                                                                                         |                                      |
| Security               | <input type="checkbox"/> Web Log-in<br><input type="checkbox"/> Telnet Log-in<br><input type="checkbox"/> SSH Log-in<br><input type="checkbox"/> TR069 Log-in<br><input type="checkbox"/> FTP User Log-in<br><input type="checkbox"/> Config Changed(From WebUI and CLI)<br><input type="checkbox"/> Brute Force Protection |                                      |

**Note:**

1. When High Availability is enabled, "Sending Interval" of **SMS Provider profile** should set to 0.
2. When the VPN Downtime limit is enabled, Vigor Router will not send the VPN Down alert immediately. It will send the Alert after the Downtime limit period if the VPN still doesn't go up.

Available settings are explained as follows:

| Item         | Description                                                                                                                                                                                                                                                              |
|--------------|--------------------------------------------------------------------------------------------------------------------------------------------------------------------------------------------------------------------------------------------------------------------------|
| Profile Name | Name that identifies this profile. Maximum length is 31 characters.                                                                                                                                                                                                      |
| Category     | Areas to be monitored.                                                                                                                                                                                                                                                   |
| Status       | <p>Select the states to be monitored.</p> <p>For example, the check box of CPE firmware upgrade fail under the category of Central VPN Management is checked. Once such profile is enabled, Vigor router system will send out notification to the recipient via SMS.</p> |

To save changes on the page, click OK. To discard changes, click Cancel. To blank out all settings in the notification object, click Clear.

## VIII-1-12 String Object

This page allows you to set string profiles which will be applied in route policy (domain name selection for destination) and etc.

Objects Setting >> String Object

10 ▼ strings per page | [Set to Factory Default](#)

| Index | String             | Clear                    |
|-------|--------------------|--------------------------|
| 1     | Draytek Hotspot    | <input type="checkbox"/> |
| 2     | portal.draytek.com | <input type="checkbox"/> |

[Add](#)

Available settings are explained as follows:

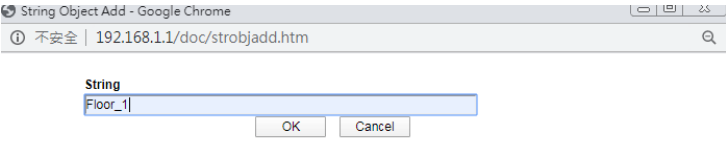
| Item                   | Description                                                                                                                                                |
|------------------------|------------------------------------------------------------------------------------------------------------------------------------------------------------|
| Add                    | Click it to open the following page for adding a new string object.<br> |
| Set to Factory Default | Click it to clear all of the settings in this page.                                                                                                        |
| Index                  | Display the number link of the string profile.                                                                                                             |
| String                 | Display the string defined.                                                                                                                                |
| Clear                  | Choose the string that you want to remove. Then click this check box to delete the selected string.                                                        |

Below shows an example to apply string object (in route policy):

Routing >> Route Policy

Index: 1

Enable

Comment  [Delete](#)

Criteria

---

Protocol  ▼

Source  ▼

Destination  ▼

-  [Select](#) [Delete](#)

[Add](#)

Destination Port  ▼

Send via if Criteria Matched



## VIII-1-13 Country Object

The country object profile can determine which country/countries shall be blocked by the Vigor router's Firewall.

Objects Setting >> Country Object

Country Object Table: [Set to Factory Default](#)

| Index               | Name | Index               | Name |
|---------------------|------|---------------------|------|
| <a href="#">1.</a>  |      | <a href="#">17.</a> |      |
| <a href="#">2.</a>  |      | <a href="#">18.</a> |      |
| <a href="#">3.</a>  |      | <a href="#">19.</a> |      |
| <a href="#">4.</a>  |      | <a href="#">20.</a> |      |
| <a href="#">5.</a>  |      | <a href="#">21.</a> |      |
| <a href="#">6.</a>  |      | <a href="#">22.</a> |      |
| <a href="#">7.</a>  |      | <a href="#">23.</a> |      |
| <a href="#">8.</a>  |      | <a href="#">24.</a> |      |
| <a href="#">9.</a>  |      | <a href="#">25.</a> |      |
| <a href="#">10.</a> |      | <a href="#">26.</a> |      |
| <a href="#">11.</a> |      | <a href="#">27.</a> |      |
| <a href="#">12.</a> |      | <a href="#">28.</a> |      |
| <a href="#">13.</a> |      | <a href="#">29.</a> |      |
| <a href="#">14.</a> |      | <a href="#">30.</a> |      |
| <a href="#">15.</a> |      | <a href="#">31.</a> |      |
| <a href="#">16.</a> |      | <a href="#">32.</a> |      |

[Objects Backup/Restore](#)



### Info

This product includes GeoLite2 data created by MaxMind, available from <https://www.maxmind.com>.

The country object, by grouping IP addresses for multiple countries, can be applied by other functions such as router policy destination (refer to the following figure for example).

Routing >> Load-Balance/Route Policy

Index: 1

Enable

Comment

Criteria

---

Protocol  ▼

Source  ▼

Destination  ▼

Destination Port  ▼

Send via if Criteria Matched  ▼

To set a new profile, please do the steps listed below:

1. Open Object Setting>>Country Object, and click the number (e.g., #1) under Index column for configuration in details.

- The configuration page will be shown as follows:

Objects Setting >> Country Object

Profile Index : 1

Name:

**Available Country**

- 58-Switzerland
- 59-Taiwan
- 60-Thailand
- 61-Turkey
- 62-Ukraine
- 63-United Arab Emirates
- 64-United Kingdom
- 65-United States
- 66-Vietnam

>>

<<

**Selected Country (Up to 16)**

[Next >>](#)

**Note:**

The maximum number of Selected Country is 16.

Available settings are explained as follows:

| Item                                 | Description                                                                                                                                                                     |
|--------------------------------------|---------------------------------------------------------------------------------------------------------------------------------------------------------------------------------|
| Name                                 | Type a name for such profile. The maximum length of the name you can set is 15 characters.                                                                                      |
| Available Country / Selected Country | Select any country from Available Country. Click >> to move the selected country and place on Selected Country. Note that one country profile can contain 1 up to 16 countries. |

- After finishing all the settings here, please click OK to save the configuration.

Objects Setting >> Country Object

Country Object Table: [Set to Factory Default](#)

| Index     | Name   | Index      | Name |
|-----------|--------|------------|------|
| <u>1.</u> | Taiwan | <u>17.</u> |      |
| <u>2.</u> |        | <u>18.</u> |      |
| <u>3.</u> |        | <u>19.</u> |      |
| <u>4.</u> |        | <u>20.</u> |      |
| <u>5.</u> |        | <u>21.</u> |      |
| <u>6.</u> |        | <u>22.</u> |      |
| <u>7.</u> |        | <u>23.</u> |      |
| <u>8.</u> |        | <u>24.</u> |      |

## VIII-1-14 Objects Backup/Restore

The objects settings can be backup as a file. The backup file can be imported to the device to restore the configuration in the future if required.

Objects Setting >> Objects Backup/Restore

**Backup**

Select All

- IP Object
- IP Group
- IPv6 Object
- IPv6 Group
- Service Type Object
- Service Type Group
- Keyword Object
- Keyword Group
- File Extension Object
- SMS/Mail Service Object
- Notification Object
- String Object
- Country Object
- Backup the current IP Objects with a CSV file
- Download the default CSV template to edit

---

**Restore**

未選擇任何檔案

**Note:**

For better compatibility, it's suggested to edit IP Objects with the provided default CSV template.

Available settings are explained as follows:

| Item    | Description                                                                                                                                                                                                                                                                                                                                                                                                                                                                                                                                                                                                                                                                                                                                                                                                                                                                                                                              |
|---------|------------------------------------------------------------------------------------------------------------------------------------------------------------------------------------------------------------------------------------------------------------------------------------------------------------------------------------------------------------------------------------------------------------------------------------------------------------------------------------------------------------------------------------------------------------------------------------------------------------------------------------------------------------------------------------------------------------------------------------------------------------------------------------------------------------------------------------------------------------------------------------------------------------------------------------------|
| Backup  | <p>Usually, the objects can be created one by one through the web page under Objects Settings. However, to a user who wants to save more time in bulk creating various objects, a quick method is offered by Vigor router to modify the objects with a single file, a CSV file.</p> <p>All of the objects (or the template) can be exported as a file by clicking Download. Then the user can open the CSV file through Microsoft Excel and modify all the IP objects at the same time.</p> <p><b>Backup the current IP Objects with a CSV file</b> - Click it to backup current IP objects as a CSV file. Such file can be restored for future use.</p> <p><b>Download the default CSV template to edit</b> - After clicking it, press Download to store the default CSV template (a table without any input data) to your hard disk.</p> <p><b>Download</b> - Download the CSV file from Vigor router and store in your hard disk.</p> |
| Restore | <p><b>Select</b> - Click it to specify a predefined CSV file.</p> <p><b>Restore</b> - Import the selected CSV file onto Vigor router.</p>                                                                                                                                                                                                                                                                                                                                                                                                                                                                                                                                                                                                                                                                                                                                                                                                |

# Application Notes

## A-1 How to Send a Notification to Specified Phone Number via SMS Service in WAN Disconnection

Follow the steps listed below:

1. Log into the web user interface of Vigor router.
2. Configure relational objects first. Open Object Settings>>SMS/Mail Server Object to get the following page.

Objects Setting >> SMS / Mail Service Object

| SMS Provider | Mail Server  |              | Set to Factory Default |
|--------------|--------------|--------------|------------------------|
| Index        | Profile Name | SMS Provider |                        |
| 1.           |              |              |                        |
| 2.           |              |              |                        |
| 3.           |              |              |                        |
| 4.           |              |              |                        |
| 5.           |              |              |                        |
| 6.           |              |              |                        |
| 7.           |              |              |                        |
| 8.           |              |              |                        |
| 9.           | Custom 1     |              |                        |
| 10.          | Custom 2     |              |                        |

Index 1 to Index 8 allows you to choose the built-in SMS service provider. If the SMS service provider is not on the list, you can configure Index 9 and Index 10 to add the new service provider to Vigor router.

3. Choose any index number (e.g., Index 1 in this case) to configure the SMS Provider setting. In the following page, Enter the username and password and set the quota that the router can send the message out.

Objects Setting >> SMS / Mail Service Object

Profile Index: 1

|                     |                                                                   |
|---------------------|-------------------------------------------------------------------|
| Profile Name        | Local number                                                      |
| Service Provider    | kotsms.com.tw (TW)                                                |
| Connection Protocol | <input checked="" type="radio"/> HTTP <input type="radio"/> HTTPS |
| Username            | abc5026                                                           |
| Password            | ...                                                               |
| Quota               | 10                                                                |
| Sending Interval    | 3 (seconds)                                                       |

Note:

1. Only one message can be sent during the "Sending Interval" time.
2. If the "Sending Interval" was set to 0, there will be no limitation.

OK Clear Cancel Send a Test Message

- After finished the settings, click OK to return to previous page. Now you have finished the configuration of the SMS Provider profile setting.

Objects Setting >> SMS / Mail Service Object

| SMS Provider |              | Mail Server        | <a href="#">Set to Factory Default</a> |
|--------------|--------------|--------------------|----------------------------------------|
| Index        | Profile Name | SMS Provider       |                                        |
| 1.           | Local number | kotsms.com.tw (TW) |                                        |
| 2.           |              |                    |                                        |
| 3.           |              |                    |                                        |
| 4.           |              |                    |                                        |
| 5.           |              |                    |                                        |
| 6.           |              |                    |                                        |
| 7.           |              |                    |                                        |
| 8.           |              |                    |                                        |
| 9.           | Custom 1     |                    |                                        |
| 10.          | Custom 2     |                    |                                        |

- Open Object Settings>>Notification Object to configure the event conditions of the notification.

Object Settings >> Notification Object

|       |              |          | <a href="#">Set to Factory Default</a> |
|-------|--------------|----------|----------------------------------------|
| Index | Profile Name | Settings |                                        |
| 1.    |              |          |                                        |
| 2.    |              |          |                                        |
| 3.    |              |          |                                        |
| 4.    |              |          |                                        |
| 5.    |              |          |                                        |
| 6.    |              |          |                                        |
| 7.    |              |          |                                        |
| 8.    |              |          |                                        |

- Choose any index number (e.g., Index 1 in this case) to configure conditions for sending the SMS. In the following page, Enter the name of the profile and check the Disconnected and Reconnected boxes for WAN to work in concert with the topic of this paper.

Objects Setting >> Notification Object

Profile Index: 1

| Profile Name           |                                                  | WAN_Notify                                      |                                |
|------------------------|--------------------------------------------------|-------------------------------------------------|--------------------------------|
| Category               | Status                                           |                                                 |                                |
| WAN                    | <input checked="" type="checkbox"/> Disconnected | <input checked="" type="checkbox"/> Reconnected |                                |
| VPN Tunnel             | <input type="checkbox"/> Disconnected            | <input type="checkbox"/> Reconnected            |                                |
| Temperature Alert      | <input type="checkbox"/> USB Out of Range        | <input type="checkbox"/> CPU Out of Range       | <input type="text" value="0"/> |
| WAN Budget             | <input type="checkbox"/> Limit Reached           |                                                 |                                |
| Central VPN Management | <input type="checkbox"/> CPE Offline             |                                                 |                                |
|                        | <input type="checkbox"/> CPE Config Backup Fail  |                                                 |                                |
|                        | <input type="checkbox"/> CPE Config Restore Fail |                                                 |                                |

- After finished the settings, click OK to return to previous page. You have finished the configuration of the notification object profile setting.

Object Settings >> Notification Object

| [Set to Factory Default](#) |

| Index | Profile Name | Settings |
|-------|--------------|----------|
| 1.    | WAN_Notify   | WAN      |
| 2.    |              |          |
| 3.    |              |          |
| 4.    |              |          |
| 5.    |              |          |
| 6.    |              |          |
| 7.    |              |          |
| 8.    |              |          |

- Now, open Application >> SMS / Mail Alert Service. Use the drop down list to choose SMS Provider and the Notify Profile (specify the time of sending SMS). Then, Enter the phone number in the field of Recipient Number (the one who will receive the SMS).

Applications >> SMS / Mail Alert Service

| [Set to Factory Default](#) |

| SMS Alert |                                     | Mail Alert       |                  |                |                |
|-----------|-------------------------------------|------------------|------------------|----------------|----------------|
| Index     | Enable                              | SMS Provider     | Recipient Number | Notify Profile | Schedule(1-15) |
| 1         | <input checked="" type="checkbox"/> | 1 - Local number | 0910222366       | 1 - WAN_Notify | None           |
| 2         | <input type="checkbox"/>            | 1 - Local number |                  | 1 - WAN_Notify | None           |
| 3         | <input type="checkbox"/>            | 1 - Local number |                  | 1 - WAN_Notify | None           |
| 4         | <input type="checkbox"/>            | 1 - Local number |                  | 1 - WAN_Notify | None           |
| 5         | <input type="checkbox"/>            | 1 - Local number |                  | 1 - WAN_Notify | None           |
| 6         | <input type="checkbox"/>            | 1 - Local number |                  | 1 - WAN_Notify | None           |
| 7         | <input type="checkbox"/>            | 1 - Local number |                  | 1 - WAN_Notify | None           |
| 8         | <input type="checkbox"/>            | 1 - Local number |                  | 1 - WAN_Notify | None           |
| 9         | <input type="checkbox"/>            | 1 - Local number |                  | 1 - WAN_Notify | None           |
| 10        | <input type="checkbox"/>            | 1 - Local number |                  | 1 - WAN_Notify | None           |

Note:

All the SMS Alert profiles share the same "Sending Interval" setting if they use the same SMS Provider.

- Click OK to save the settings. Later, if one of the WAN connections fails in your router, the system will send out SMS to the phone number specified. If the router has only one WAN interface, the system will send out SMS to the phone number while reconnecting the WAN interface successfully.

## Remark: How the customize the SMS Provider

Choose one of the Index numbers (9 or 10) allowing you to customize the SMS Provider. In the web page, Enter the URL string of the SMS provider and Enter the username and password. After clicking OK, the new added SMS provider will be added and will be available for you to specify for sending SMS out.

Objects Setting >> SMS / Mail Service Object

Profile Index: 9

|                                                                                                                                                                                                                    |                                          |
|--------------------------------------------------------------------------------------------------------------------------------------------------------------------------------------------------------------------|------------------------------------------|
| Profile Name                                                                                                                                                                                                       | <input type="text" value="Custom 1"/>    |
| Service Provider                                                                                                                                                                                                   | <input type="text" value="clickatell"/>  |
| <div style="border: 1px solid black; padding: 5px; min-height: 40px;">Max: 255 characters</div>                                                                                                                    |                                          |
| Please contact with your SMS provide to get the exact URL String<br>eg:bulksms.vsms.net:5567/eapi/submission/send_sms/2/2.0?username=###txtUser###&password=###txtPwd###&msisdn=###txtDest###&message=###txtMsg### |                                          |
| Server Response                                                                                                                                                                                                    | <input type="text" value="test333"/>     |
| Username                                                                                                                                                                                                           | <input type="text" value="ilan123"/>     |
| Password                                                                                                                                                                                                           | <input type="password" value="*****"/>   |
| Quota                                                                                                                                                                                                              | <input type="text" value="10"/>          |
| Sending Interval                                                                                                                                                                                                   | <input type="text" value="3"/> (seconds) |

**Note:**

1. Only one message can be sent during the "Sending Interval" time.
2. If the "Sending Interval" was set to 0, there will be no limitation.

---

## VIII-2 USB Application

USB devices connected to the Vigor router can function as storage servers, WAN interfaces, network printers or thermometers.

After setting the configuration in USB Application, a USB storage device can be accessed using either the FTP or SMB protocol from LAN clients with the IP address of the Vigor router and the username and password entered in USB Application>>USB User Management.



---

### Info

---

USB modems that are supported by the router are listed in USB Application>>Modem Support List. For network connection via USB modem, refer to WAN>>Internet Access and WAN>>General Setup for detailed information.

---



---

# Web User Interface

- SSL VPN
- USB Application
  - USB General Settings
  - USB User Management
- File Explorer
- USB Device Status
- Temperature Sensor
- Modem Support List
- SMB Client Support List
- System Maintenance

---

## VIII-2-1 USB General Settings

This page allows you to configure the file sharing feature of the Vigor router, where USB mass storage devices such as thumb drives and hard drives can be made accessible to LAN clients. Currently, only FAT16 and FAT32 file systems are supported by the Vigor router, so verify that the USB drive contains these file systems. FAT32 is recommended because of its long filename support, which FAT16 lacks.

USB Application >> USB General Settings

### USB General Settings

|                                                                             |                                            |
|-----------------------------------------------------------------------------|--------------------------------------------|
| <b>General Settings</b>                                                     |                                            |
| Simultaneous FTP Connections                                                | <input type="text" value="5"/> (Maximum 6) |
| Default Charset                                                             | <input type="text" value="English"/>       |
| <b>SMB File Sharing Service (Network Neighborhood)</b>                      |                                            |
| <input type="radio"/> Enable <input checked="" type="radio"/> Disable       |                                            |
| <b>Access Mode</b>                                                          |                                            |
| <input checked="" type="radio"/> LAN Only <input type="radio"/> LAN And WAN |                                            |
| <b>NetBios Name Service</b>                                                 |                                            |
| Workgroup Name                                                              | <input type="text" value="WORKGROUP"/>     |
| Host Name                                                                   | <input type="text" value="Vigor"/>         |
| <b>Printer Server</b>                                                       |                                            |
| <input type="radio"/> Enable <input checked="" type="radio"/> Disable       |                                            |

**Note:**

1. If character set is set to "English", only English long file name is supported.
2. Multi-session FTP download will be banned by Router FTP server. If your FTP client has a multi-connection mechanism, such as FileZilla, you should limit client connections to 1 to improve performance.
3. A workgroup name must be different from the host name. The workgroup name can have up to 15 characters and the host name can have up to 15 characters. Names cannot contain any of the following: . ; : " < > \* + = / \ | ?.

OK

Available settings are explained as follows:

| Item             | Description                                                                                                                                                                                                                                                          |
|------------------|----------------------------------------------------------------------------------------------------------------------------------------------------------------------------------------------------------------------------------------------------------------------|
| General Settings | Simultaneous FTP Connections - Enter the maximum number of simultaneous FTP sessions allowed. The router allows up to 6 simultaneous sessions.<br>Default Charset - Select the character set for file and directory names. Currently, the Vigor router supports four |

|                          |                                                                                                                                                                                                                                                                                                                                                                                                 |
|--------------------------|-------------------------------------------------------------------------------------------------------------------------------------------------------------------------------------------------------------------------------------------------------------------------------------------------------------------------------------------------------------------------------------------------|
|                          | character sets. The default charset is English.                                                                                                                                                                                                                                                                                                                                                 |
| SMB File Sharing Service | Click Enable to enable SMB service (file sharing).                                                                                                                                                                                                                                                                                                                                              |
| Access Mode              | LAN Only - Only users on the LAN can connect access the shared USB disk.<br>LAN And WAN - Both LAN and WAN users can access SMB server of the router.                                                                                                                                                                                                                                           |
| NetBios Name Service     | For SMB file sharing service, you need to specify a workgroup name and a host name. The two names cannot be identical, and neither can contain any of the following characters: ; : " < > * + = \   ?<br>Workgroup Name - Enter the workgroup name. Maximum allowed length is 15 characters.<br>Host Name - Enter the NetBIOS hostname for the router. Maximum allowed length is 23 characters. |
| Printer Server           | Enable - Select to allow the Vigor router to act as a print server for printers connected the USB.                                                                                                                                                                                                                                                                                              |

Select OK to save changes on the page.

## VIII-2-2 USB User Management

This page allows you to set up profiles for FTP/SMB users. Any user who wants to access the USB storage disk must authenticate using a username and password that have been configured on this page. Please connect a USB storage device before adding or modifying settings on this page, or else an error message will appear requesting you to do so before allowing you to proceed.

USB Application >> USB User Management

USB User Management | [Set to Factory Default](#) |

| Index      | Enable                   | Username | Home Folder | File Access Rule | Directory Access Rule |
|------------|--------------------------|----------|-------------|------------------|-----------------------|
| <u>1.</u>  | <input type="checkbox"/> |          |             |                  |                       |
| <u>2.</u>  | <input type="checkbox"/> |          |             |                  |                       |
| <u>3.</u>  | <input type="checkbox"/> |          |             |                  |                       |
| <u>4.</u>  | <input type="checkbox"/> |          |             |                  |                       |
| <u>5.</u>  | <input type="checkbox"/> |          |             |                  |                       |
| <u>6.</u>  | <input type="checkbox"/> |          |             |                  |                       |
| <u>7.</u>  | <input type="checkbox"/> |          |             |                  |                       |
| <u>8.</u>  | <input type="checkbox"/> |          |             |                  |                       |
| <u>9.</u>  | <input type="checkbox"/> |          |             |                  |                       |
| <u>10.</u> | <input type="checkbox"/> |          |             |                  |                       |
| <u>11.</u> | <input type="checkbox"/> |          |             |                  |                       |
| <u>12.</u> | <input type="checkbox"/> |          |             |                  |                       |
| <u>13.</u> | <input type="checkbox"/> |          |             |                  |                       |
| <u>14.</u> | <input type="checkbox"/> |          |             |                  |                       |
| <u>15.</u> | <input type="checkbox"/> |          |             |                  |                       |

Click index number to access into configuration page.

Profile Index: 1

|                                            |                                                                                                                               |
|--------------------------------------------|-------------------------------------------------------------------------------------------------------------------------------|
| <input checked="" type="checkbox"/> Enable |                                                                                                                               |
| Username                                   | <input type="text" value="carrie"/>                                                                                           |
| Password                                   | <input type="password" value="*****"/>                                                                                        |
| Confirm Password                           | <input type="password" value="*****"/>                                                                                        |
| Home Folder                                | <input type="text"/>                       |
| <b>Access Rule</b>                         |                                                                                                                               |
| File                                       | <input checked="" type="checkbox"/> Read <input checked="" type="checkbox"/> Write <input checked="" type="checkbox"/> Delete |
| Directory                                  | <input checked="" type="checkbox"/> List <input type="checkbox"/> Create <input type="checkbox"/> Remove                      |

**Note:**

The folder name can only contain the following characters: A-Z a-z 0-9 \$ % ' - \_ @ ~ ` ! ( ) and space.

Available settings are explained as follows:

| Item             | Description                                                                                                                                                                                                                                                                                                                                                                                                                                                                                                                             |
|------------------|-----------------------------------------------------------------------------------------------------------------------------------------------------------------------------------------------------------------------------------------------------------------------------------------------------------------------------------------------------------------------------------------------------------------------------------------------------------------------------------------------------------------------------------------|
| Enable           | Check to activate this profile (account) for FTP service and / or SMB service. Later, the user can use the username specified in this page to login into FTP server.                                                                                                                                                                                                                                                                                                                                                                    |
| Username         | Enter the username for this user profile. Maximum allowed length of the username is 11 characters.<br>Note: Anonymous user access is not supported.<br>Note: "Admin" cannot be used as a username, as it is reserved for access to web pages on the Vigor router, and for FTP firmware upgrade.<br>Note: Ensure that the FTP client does not use passive FTP mode as it is not supported by the Vigor router.                                                                                                                           |
| Password         | Enter the password for this user profile. Maximum allowed length of the password is 11 characters.                                                                                                                                                                                                                                                                                                                                                                                                                                      |
| Confirm Password | Enter the password again to confirm.                                                                                                                                                                                                                                                                                                                                                                                                                                                                                                    |
| Home Folder      | Enter the folder which will be the root folder for FTP and SMB sessions established using the credentials of this user profile. Only folders and files inside this selected root folder are accessible to the user. In addition, if the user types "/" here, the user can access into all of the disk folders and files in USB storage disk.<br>To browse the list of folders available for selection, or to create a new folder, click the  icon. |

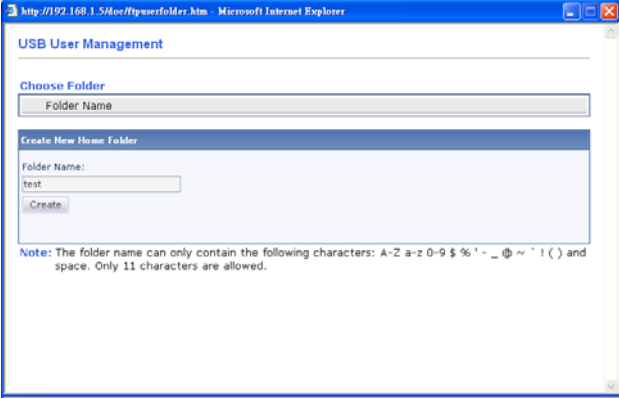
|                    |                                                                                                                                                                                                                                                                                                                       |
|--------------------|-----------------------------------------------------------------------------------------------------------------------------------------------------------------------------------------------------------------------------------------------------------------------------------------------------------------------|
|                    |  <p>Note: If the USB storage device is write-protected, new folders cannot be created. Only existing folders can be selected.</p> <p>Note: Only folders directly under the root can be selected as the home folder.</p>             |
| <p>Access Rule</p> | <p>It determines the authority for such profile. Any user, who uses such profile for accessing into USB storage disk, must follow the rule specified here.</p> <p>File - Check the items (Read, Write and Delete) for such profile.</p> <p>Directory -Check the items (List, Create and Remove) for such profile.</p> |

To save changes on this page, ensure that a USB storage device is connected, and click OK. To discard changes, click Cancel. To blank out all settings in the current IP object, click Clear.

## VIII-2-3 File Explorer

File Explorer offers an easy way for users to view and manage the content of USB storage disk connected on Vigor router.

USB Application >> File Explorer

File Explorer



Current Path: /

| Name                                                                                                                                            | Size | Delete | Rename |
|-------------------------------------------------------------------------------------------------------------------------------------------------|------|--------|--------|
| <p><b>Upload File</b></p> <p>Select a file:</p> <input type="text"/> <input type="button" value="瀏覽..."/> <input type="button" value="Upload"/> |      |        |        |

Note: The folder can not be deleted when it is not empty.

Available settings are explained as follows:

| Item                                                                                        | Description                                               |
|---------------------------------------------------------------------------------------------|-----------------------------------------------------------|
|  Refresh | Click this icon to refresh the list of files and folders. |

|                                                                                          |                                                                                                                                                                                                                   |
|------------------------------------------------------------------------------------------|-------------------------------------------------------------------------------------------------------------------------------------------------------------------------------------------------------------------|
|  Back   | Click this icon to return to the parent folder.                                                                                                                                                                   |
|  Create | Click this icon to add a new folder.                                                                                                                                                                              |
| Current Path                                                                             | Shows current folder.                                                                                                                                                                                             |
| Upload                                                                                   | To upload a file to the USB storage device, click the Browse... button to bring up the file selection dialog box. Select the file you wish to upload, and click the Upload button to initiate the upload process. |

## VIII-2-4 USB Device Status

This page allows monitoring of the status of USB devices (disk, modem, printer, and sensor) connected to the Vigor router. To maintain the data integrity of a USB disk that is connected to the router, always click Disconnect USB Disk before unplugging the disk from the router.

USB Application >> USB Device Status

| Disk                                        | Modem          | Printer                 | Sensor          | <a href="#">Refresh</a>                            |
|---------------------------------------------|----------------|-------------------------|-----------------|----------------------------------------------------|
| <b>USB Mass Storage Device Status</b>       |                |                         |                 |                                                    |
| Connection Status: <b>No Disk Connected</b> |                |                         |                 | <input type="button" value="Disconnect USB Disk"/> |
| Disk Capacity: 0 MB                         |                |                         |                 |                                                    |
| Free Capacity: 0 MB <a href="#">Refresh</a> |                |                         |                 |                                                    |
| <b>USB Disk Users Connected</b>             |                |                         |                 |                                                    |
| <b>Index</b>                                | <b>Service</b> | <b>IP Address(Port)</b> | <b>Username</b> |                                                    |

Available settings are explained as follows:

| Item                     | Description                                                                                                                                                                                                                                                                                                                                               |
|--------------------------|-----------------------------------------------------------------------------------------------------------------------------------------------------------------------------------------------------------------------------------------------------------------------------------------------------------------------------------------------------------|
| Connection Status        | Shows whether a USB disk is connected or not. If there is no USB device connected to the Vigor router, “No Disk Connected” will be displayed.                                                                                                                                                                                                             |
| Disk Capacity            | Shows the total capacity of the USB storage disk.                                                                                                                                                                                                                                                                                                         |
| Free Capacity            | Shows the free space on the USB storage disk. Click Refresh at any time to get the most up-to-date free capacity.                                                                                                                                                                                                                                         |
| USB Disk Users Connected | Shows the clients that are connected to the SMB/FTP server.<br><b>Index</b> - The profile index used by the LAN client to establish the connection.<br><b>Service</b> - Shows whether the connection is using FTP or SMB.<br><b>IP Address</b> - Shows the client’s IP address.<br><b>Username</b> - Shows the username used to establish the connection. |
| Disconnect USB Disk      | Before unplugging the USB storage device from the router, make sure you click this first to ensure that all data has been written to the disk and all open files are closed.                                                                                                                                                                              |

After a USB storage device has been connected, the Connection Status will be updated within a few seconds.

## USB Application >> USB Device Status

| Disk                                  | Modem   | Printer          | Sensor   | Refresh             |
|---------------------------------------|---------|------------------|----------|---------------------|
| <b>USB Mass Storage Device Status</b> |         |                  |          |                     |
| Connection Status: Disk Connected     |         |                  |          | Disconnect USB Disk |
| Write Protect Status: No              |         |                  |          |                     |
| Disk Capacity: 2009 MB                |         |                  |          |                     |
| Free Capacity: 925 MB Refresh         |         |                  |          |                     |
| <b>USB Disk Users Connected</b>       |         |                  |          |                     |
| Index                                 | Service | IP Address(Port) | Username |                     |

## VIII-2-5 Temperature Sensor

A USB Thermometer is now available. It complements your installed DrayTek router installations which will help you monitor the server or data communications room environment and notify you if the server room or data communications room is overheating.



During summer in particular, it is important to ensure that your server or data communications equipment are not overheating due to cooling system failures.

The inclusion of a USB thermometer in compatible Vigor routers will continuously monitor the temperature of its environment. When a pre-determined threshold is reached you will be alerted by either an email or SMS so you can undertake appropriate action.

For a list of supported USB thermometers, visit our website at <https://www.draytek.com/en/products/usb-thermometer/> or contact your local DrayTek partner.

## Temperature Sensor Settings

USB Application >> Temperature Sensor Setting

| Temperature Chart                            | Temperature Sensor Settings                                               |
|----------------------------------------------|---------------------------------------------------------------------------|
| <b>Display Settings</b>                      |                                                                           |
| Temperature Calibration                      | <input type="text" value="0.00"/>                                         |
| Temperature Unit                             | <input checked="" type="radio"/> Celsius <input type="radio"/> Fahrenheit |
| <b>Alarm Settings</b>                        |                                                                           |
| <input type="checkbox"/> Enable Syslog Alarm |                                                                           |
| Upper temperature limit                      | <input type="text" value="30.00"/>                                        |
| Lower temperature limit                      | <input type="text" value="18.00"/>                                        |

**Note:**

Set 1) [Notification Object](#), 2) [SMS / Mail Service Object](#), 3) [SMS / Mail Alert Service](#) to make Vigor router send alert when the temperature reaches the limit.

OK

Available settings are explained as follows:

| Item             | Description                                                                                                                                                                                                                                              |
|------------------|----------------------------------------------------------------------------------------------------------------------------------------------------------------------------------------------------------------------------------------------------------|
| Display Settings | Temperature Calibration - Enter the difference between the actual temperature and the temperature as reported by the thermometer.<br>Temperature Unit - Select the temperature scale to be used.                                                         |
| Alarm Settings   | Enable Syslog Alarm - Select to enable recording of the temperature in Syslog.<br>Upper temperature limit/Lower temperature limit - Enter the upper and lower temperature limits. If the temperature falls outside of this range, an alert will be sent. |

## Temperature Chart

Below shows an example of temperature graph:

USB Application >> Temperature Sensor Graph

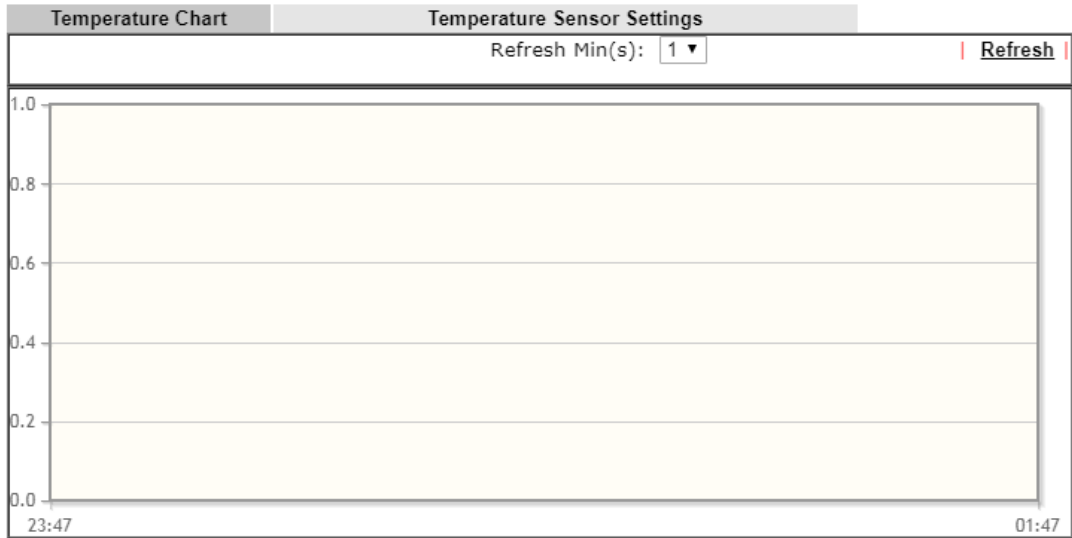

Manufacturer:  
Product:  
Current Temperature:  
Average Temperature:  
Maximum Temperature:  
Minimum Temperature:



## VIII-2-6 Modem Support List

This page lists the brands and models of USB modems that are supported by the Vigor router. This list is subject to change between different versions of firmware as support for new modems are added.

### USB Application >> Modem Support List

The following compatibility test lists 3.5G/LTE modems **supported by Vigor router under certain environment or countries**. If the LTE modem you have is on the list but cannot work properly, please write an e-mail to support@draytek.com or consult your dealer for further information.

| Brand     | Model                     | LTE | Access Mode | Status |
|-----------|---------------------------|-----|-------------|--------|
| 4G system | XSPlug P3                 |     | PPP         | Y      |
| Aiko      | Aiko 76E                  |     | PPP         | Y      |
| Alcatel   | Alcatel L100V             | ✔   | DHCP        | Y      |
|           | Alcatel L800              | ✔   | DHCP        | Y      |
|           | Alcatel W100              | ✔   | DHCP        | Y      |
|           | Alcatel W800              | ✔   | DHCP        | Y      |
|           | Alcatel X500              |     | PPP         | Y      |
|           | Alcatel Y855              | ✔   | DHCP        | Y      |
| Alfa      | ALFA Flyppp               |     | PPP         | Y      |
| Amoi      | Amoi H01                  |     | PPP         | Y      |
| BandRich  | Bandlux C321              |     | PPP         | Y      |
|           | Bandlux C330              |     | PPP         | Y      |
|           | Bandlux C331              |     | PPP         | Y      |
|           | Bandlux C502              |     | PPP         | Y      |
| BigPond   | BigPond Next G Wireless   |     | PPP         | Y      |
|           | Broadband USB Mobile Card |     | PPP         | Y      |
| D-Link    | <u>D_LINK DWM156</u>      |     | DHCP        | M      |
|           | Huawei E150               |     | PPP         | Y      |
|           | Huawei E153               |     | PPP         | Y      |
|           | Huawei E172               |     | PPP         | Y      |
|           | Huawei E176c              |     | PPP         | M      |
|           | Huawei E270               |     | PPP         | Y      |

---

## VIII-2-7 SMB Client Support List

This page shows a list of SMB clients on various platforms, and their levels of compatibility with the Vigor router as determined by our in-house testing. This list is subject to change as support for SMB clients are added or improved.

**USB Application >> SMB Client Support List**



The following compatibility test lists suggested SMB clients supported by Vigor router.

| Platform                  | Application      | Status |
|---------------------------|------------------|--------|
| Microsoft® Windows® XP    | Built in         | I      |
| Microsoft® Windows Vista™ | Built in         | Y      |
| Microsoft® Windows® 7     | Built in         | Y      |
| Microsoft® Windows® 8     | Built in         | M      |
| Microsoft® Windows® 10    | Built in         | Y      |
| OS X® 10.7.5              | Built in         | Y      |
| OS X® 10.10               | Built in         | Y      |
| Ubuntu 14.04              | Built in         | Y      |
| Android™                  | AndSMB           | Y      |
| Android™                  | ES File Explorer | Y      |
| Android™                  | File Expert      | Y      |
| Android™                  | File Manager     | Y      |
| Android™                  | Solid Explorer   | Y      |
| Android™                  | SharesFinder     | Y      |
| iOS                       | eXPlayer         | Y      |
| iOS                       | nPlayer          | Y      |

Y: Tested and is supported.

I: Supported but has some issue.

M: Has not been tested but might be supported.

# Application Notes

## A-1 How can I get the files from USB storage device connecting to Vigor router?

Files on USB storage device can be reviewed by opening USB Application>>File Explorer. If it is necessary for you to delete, copy files on the device or write, paste files to the device, it must be done through SMB server or FTP server.

SMB service is based on the original USB FTP service. You will need to setup USB FTP first. We would like to give brief instructions on USB FTP setup here.

1. Plug the USB device to the USB port on the router. Make sure Disk Connected appears on the Connection Status as the figure shown below:

USB Application >> USB Device Status

| Disk                                  | Modem          | Printer          | Sensor   | Refresh             |
|---------------------------------------|----------------|------------------|----------|---------------------|
| <b>USB Mass Storage Device Status</b> |                |                  |          |                     |
| Connection Status:                    | Disk Connected |                  |          | Disconnect USB Disk |
| Write Protect Status:                 | No             |                  |          |                     |
| Disk Capacity:                        | 2009 MB        |                  |          |                     |
| <b>USB Disk Users Connected</b>       |                |                  |          |                     |
| Index                                 | Service        | IP Address(Port) | Username |                     |

**Note:**

1. Only support FAT16 and FAT32 format, FAT32 is recommended.
2. Only support to mount single partition, maximum capacity is 500GB. If there are more than one partition, only one of them will be mounted.
3. Single file size can be up to 4GB, which is the limitation of FAT32 format.
4. If the write protect switch of USB disk is turned on, the USB disk is in **READ-ONLY** mode. No data can be written to it.

2. Then, please open USB Application >> USB General Settings to enable SMB service.

USB Application >> USB General Settings

**USB General Settings**

**General Settings**

Simultaneous FTP Connections: 5 (Maximum 6)

Default Charset: English

**SMB File Sharing Service (Network Neighborhood)**

Enable  Disable

**Access Mode**

LAN Only  LAN And WAN

**NetBios Name Service**

Workgroup Name: WORKGROUP

Host Name: Vigor

**Printer Server**

Enable  Disable

**Note:**

1. If character set is set to "English", only English long file name is supported.
2. Multi-session FTP download will be banned by Router FTP server. If your FTP client has a multi-connection mechanism, such as FileZilla, you should limit client connections to 1 to improve performance.
3. A workgroup name must be different from the host name. The workgroup name can have up to 15 characters and the host name can have up to 15 characters. Names cannot contain any of the following: . ; : " < > \* + = / \ | ?.

OK

3. Setup a user account for the FTP service by using **USB Application >>USB User Management**. Click **Enable** to enable FTP/SMB User account. In the example below, we have set up a new account with the username "user1", and granted "Read", "Write", "Delete" and "List" permissions to it.

USB Application >> USB User Management

Profile Index: 1

|                                            |                                          |                                           |                                            |
|--------------------------------------------|------------------------------------------|-------------------------------------------|--------------------------------------------|
| <input checked="" type="checkbox"/> Enable |                                          |                                           |                                            |
| Username                                   | user1                                    |                                           |                                            |
| Password                                   | .....                                    |                                           |                                            |
| Confirm Password                           | .....                                    |                                           |                                            |
| Home Folder                                |                                          |                                           |                                            |
| <b>Access Rule</b>                         |                                          |                                           |                                            |
| File                                       | <input checked="" type="checkbox"/> Read | <input checked="" type="checkbox"/> Write | <input checked="" type="checkbox"/> Delete |
| Directory                                  | <input checked="" type="checkbox"/> List | <input type="checkbox"/> Create           | <input type="checkbox"/> Remove            |

**Note:**  
The folder name can only contain the following characters: A-Z a-z 0-9 \$ % ' - \_ @ ~ ` ! ( ) and space.

OK Clear Cancel

4. Click **OK** to save the configuration.
5. To verify that the FTP service is running properly, open a browser window and enter ftp://192.168.1.1 as the destination. Replace 192.168.1.1 with the actual IP address of the router. When prompted to enter the login credentials, enter the username "user1" to login.

**Log On As**

Either the server does not allow anonymous logins or the e-mail address was not accepted.

FTP server: 192.168.1.1

User name: user1

Password: .....

After you log on, you can add this server to your Favorites and return to it easily.

FTP does not encrypt or encode passwords or data before sending them to the server. To protect the security of your passwords and data, use Web Folders (WebDAV) instead.

Learn more about [using Web Folders](#).

Log on anonymously  Save password

Log On Cancel

6. When the following screen appears, you have successfully connected to the FTP server and verified that it is running properly.

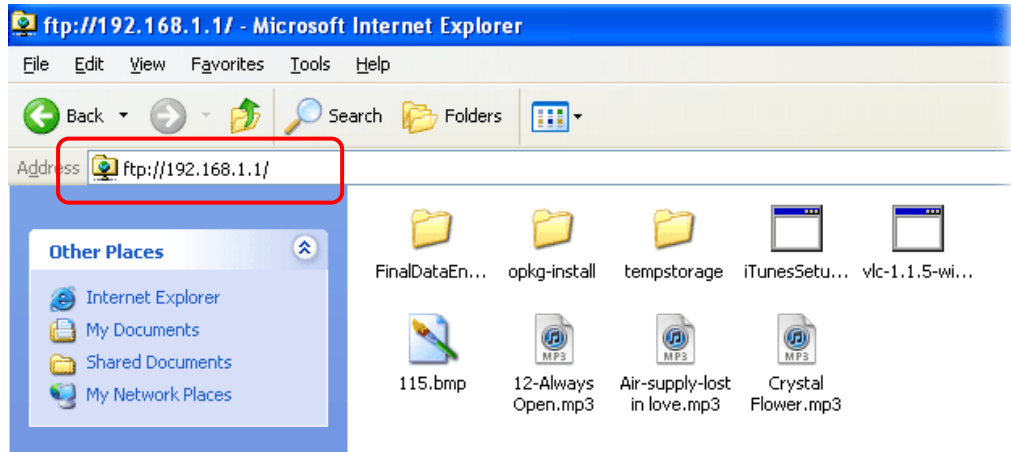

7. If you check USB Application >> USB Disk Status on browser, you will see the FTP session initiated by user1.

USB Application >> USB Device Status

| Disk                                                                 | Modem   | Printer            | Sensor   | Refresh                                            |
|----------------------------------------------------------------------|---------|--------------------|----------|----------------------------------------------------|
| <b>USB Mass Storage Device Status</b>                                |         |                    |          |                                                    |
| Connection Status: <span style="color: green;">Disk Connected</span> |         |                    |          | <input type="button" value="Disconnect USB Disk"/> |
| Write Protect Status: <span style="color: green;">No</span>          |         |                    |          |                                                    |
| Disk Capacity: 2009 MB                                               |         |                    |          |                                                    |
| <b>USB Disk Users Connected</b>                                      |         |                    |          | Refresh                                            |
| Index                                                                | Service | IP Address(Port)   | Username | Drop                                               |
| 1.                                                                   | FTP     | 192.168.1.10(1963) | user1    | <input type="button" value="Drop"/>                |

**Note:**

1. Only support FAT16 and FAT32 format, FAT32 is recommended.
2. Only support to mount single partition, maximum capacity is 500GB. If there are more than one partition, only one of them will be mounted.
3. Single file size can be up to 4GB, which is the limitation of FAT32 format.
4. If the write protect switch of USB disk is turned on, the USB disk is in **READ-ONLY** mode. No data can be written to it.

Now, users in LAN of Vigor2927 can access into the USB storage device by entering ftp://192.168.1.1 on any browser. They can add or remove files / directories, depending on the Access Rule for FTP account settings in USB Application >>USB User Management.

This page is left blank.

# Part IX Troubleshooting



Troubleshooting

This part will guide you to solve abnormal situations if you cannot access into the Internet after installing the router and finishing the web configuration.

---

## IX-1 Diagnostics

This section will guide you to solve abnormal situations if you cannot access into the Internet after installing the router and finishing the web configuration. Please follow sections below to check your basic installation status stage by stage.

- Checking if the hardware status is OK or not.
- Checking if the network connection settings on your computer are OK or not.
- Pinging the router from your computer.
- Checking if the ISP settings are OK or not.
- Backing to factory default setting if necessary.

If all above stages are done and the router still cannot run normally, it is the time for you to contact your dealer or DrayTek technical support for advanced help.



---

## Web User Interface

First, take a look at the menu items under Diagnostics. Diagnostic Tools provide a useful way to view or diagnose the status of your Vigor router.

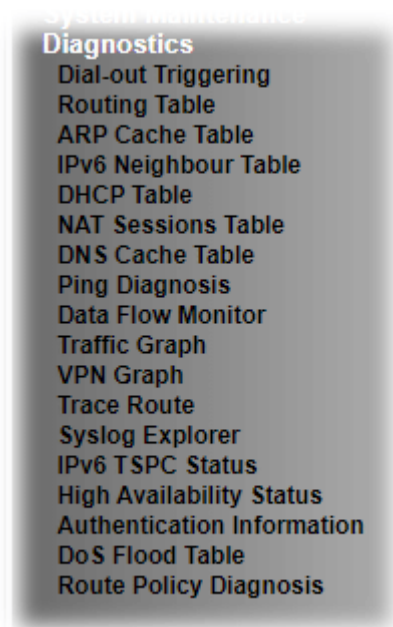

---

### IX-1-1 Dial-out Triggering

Click Diagnostics and click Dial-out Triggering to open the web page. The internet connection (e.g., PPPoE) is triggered by a package sending from the source IP address.

Diagnostics >> Dial-out Triggering

Dial-out Triggered Packet Header [Refresh](#)

```
HEX Format:  
00 00 00 00 00 00 00-00 00 00 00 00 00-00 00  
  
00 00 00 00 00 00 00 00 00-00 00 00 00 00 00 00  
00 00 00 00 00 00 00 00 00-00 00 00 00 00 00 00  
00 00 00 00 00 00 00 00 00-00 00 00 00 00 00 00  
00 00 00 00 00 00 00 00 00-00 00 00 00 00 00 00  
  
Decoded Format:  
  
0.0.0.0 -> 0.0.0.0  
Pr 0 len 0 (0)
```

Available settings are explained as follows:

| Item           | Description                                                                                                      |
|----------------|------------------------------------------------------------------------------------------------------------------|
| Decoded Format | It shows the source IP address (local), destination IP (remote) address, the protocol and length of the package. |
| Refresh        | Click it to reload the page.                                                                                     |

## IX-1-2 Routing Table

Click Diagnostics and click Routing Table to open the web page.

Diagnostics >> View Routing Table

**IPv4 Routing Table** | Refresh |

| Key | Destination                   | Gateway            | Interface |
|-----|-------------------------------|--------------------|-----------|
| S~  | 192.168.10.0/ 255.255.255.255 | via 192.168.1.2    | LAN1      |
| C~  | 192.168.1.0/ 255.255.255.0    | directly connected | LAN1      |
| S~  | 211.100.88.0/ 255.255.255.255 | via 192.168.1.3    | LAN1      |

Key

C: Connected S: Static R: RIP \*: default ~: private B: BGP

**IPv6 Routing Table**  Show Detail | Refresh |

| Destination | Interface | Flags | Metric | Next Hop |
|-------------|-----------|-------|--------|----------|
| FE80::/64   | LAN1      | U     | 256    | ::       |
| FE80::/64   | LAN2      | U     | 256    | ::       |
| FE80::/64   | LAN3      | U     | 256    | ::       |
| FE80::/64   | LAN4      | U     | 256    | ::       |
| FE80::/64   | LAN5      | U     | 256    | ::       |
| FE80::/64   | LAN6      | U     | 256    | ::       |
| FE80::/64   | LAN7      | U     | 256    | ::       |
| FE80::/64   | LAN8      | U     | 256    | ::       |
| FE80::/64   | DMZ       | U     | 256    | ::       |
| FF00::/8    | LAN1      | U     | 256    | ::       |
| FF00::/8    | LAN2      | U     | 256    | ::       |
| FF00::/8    | LAN3      | U     | 256    | ::       |
| FF00::/8    | LAN4      | U     | 256    | ::       |
| FF00::/8    | LAN5      | U     | 256    | ::       |

Flag

U: Route UP F: Default Route G: Use Next Hop S: Static Route R: RIPng

Available settings are explained as follows:

| Item    | Description                  |
|---------|------------------------------|
| Refresh | Click it to reload the page. |

## IX-1-3 ARP Cache Table

Click Diagnostics and click ARP Cache Table to view the content of the ARP (Address Resolution Protocol) cache held in the router. The table shows a mapping between an Ethernet hardware address (MAC Address) and an IP address.

Diagnostics >> View ARP Cache Table

LANWAN

Show: ALL LANs and ALL VLANs

[Clear](#) | [Refresh](#)

| IP Address  | MAC Address       | HOST ID | Interface | VLAN | P |
|-------------|-------------------|---------|-----------|------|---|
| 192.168.1.9 | 60-A4-4C-E6-5A-4F |         | LAN1      | ---  | P |

Show Comment

Available settings are explained as follows:

| Item    | Description                                                                                                                        |
|---------|------------------------------------------------------------------------------------------------------------------------------------|
| Show    | Specify LAN and VLAN to display related information. In default, this page will display all of the information about LAN and VLAN. |
| Refresh | Click it to reload the page.                                                                                                       |

---

## IX-1-4 IPv6 Neighbour Table

The table shows a mapping between an Ethernet hardware address (MAC Address) and an IPv6 address. This information is helpful in diagnosing network problems, such as IP address conflicts, etc.

Click Diagnostics and click IPv6 Neighbour Table to open the web page.

Diagnostics >> IPv6 Neighbour Table

| IPv6 Neighbour Table |                   |           |     | <a href="#">Refresh</a> |
|----------------------|-------------------|-----------|-----|-------------------------|
| IPv6 Address         | Mac Address       | Interface | Sta |                         |
| FF02::1              | 33-33-00-00-00-01 | LAN1      | CON |                         |

Available settings are explained as follows:

| Item    | Description                  |
|---------|------------------------------|
| Refresh | Click it to reload the page. |

## IX-1-5 DHCP Table

The facility provides information on IP address assignments. This information is helpful in diagnosing network problems, such as IP address conflicts, etc.

Click Diagnostics and click DHCP Table to open the web page.

Diagnostics >> View DHCP Assigned IP Addresses

### IPv4 Address Assignment Table

Show :

| Dynamic IP Assignment Table |                  | Static IP Assignment Table             |             | <input type="checkbox"/> Show Comment | <a href="#">Refresh</a> |
|-----------------------------|------------------|----------------------------------------|-------------|---------------------------------------|-------------------------|
| Index                       | IP Address       | MAC Address                            | Leased Time | HOST ID                               |                         |
| -----                       |                  |                                        |             |                                       |                         |
| [LAN1                       | : DHCP Server On | IP Pool: 192.168.1.10 ~ 192.168.1.209] |             |                                       |                         |

### IPv6 Address Assignment Table

[Refresh](#)

| Index | IPv6 Address | IAID | Link-layer Address | Leased Time |
|-------|--------------|------|--------------------|-------------|
| ----- |              |      |                    |             |
|       |              |      |                    |             |

Available settings are explained as follows:

| Item        | Description                                                                            |
|-------------|----------------------------------------------------------------------------------------|
| Index       | It displays the connection item number.                                                |
| IP Address  | It displays the IP address assigned by this router for specified PC.                   |
| MAC Address | It displays the MAC address for the specified PC that DHCP assigned IP address for it. |
| Leased Time | It displays the leased time of the specified PC.                                       |
| HOST ID     | It displays the host ID name of the specified PC.                                      |
| Refresh     | Click it to reload the page.                                                           |



## IX-1-7 DNS Cache Table

Click Diagnostics and click DNS Cache Table to open the web page.

The record of domain Name and the mapping IP address for answering the DNS query from LAN will be stored on Vigor router's Cache temporarily and displayed on Diagnostics >> DNS Cache Table.

Diagnostics >> DNS Cache Table

### IPv4 DNS Cache Table

| [Clear](#) | [Refresh](#) |

| Domain Name | IP Address | TTL (s) |
|-------------|------------|---------|
| -----       |            |         |
|             |            |         |
|             |            |         |
|             |            |         |
|             |            |         |
|             |            |         |
|             |            |         |
|             |            |         |
|             |            |         |
|             |            |         |

### IPv6 DNS Cache Table

| [Clear](#) | [Refresh](#) |

| Domain Name | IP Address | TTL (s) |
|-------------|------------|---------|
| -----       |            |         |
|             |            |         |
|             |            |         |
|             |            |         |
|             |            |         |
|             |            |         |
|             |            |         |
|             |            |         |
|             |            |         |
|             |            |         |

**Note:**

An entry of which TTL shows "Static" is a domain name created in [LAN DNS](#).

When an entry's TTL is larger than  s, this entry will be deleted from the table.

OK

Available settings are explained as follows:

| Item                                   | Description                                                                                                                                                                                                                                                                               |
|----------------------------------------|-------------------------------------------------------------------------------------------------------------------------------------------------------------------------------------------------------------------------------------------------------------------------------------------|
| Clear                                  | Click this link to remove the result on the window.                                                                                                                                                                                                                                       |
| Refresh                                | Click it to reload the page.                                                                                                                                                                                                                                                              |
| When an entry's TTL is larger than.... | Check the box the Enter the value of TTL (time to live) for each entry. Click OK to enable such function.<br>It means when the TTL value of each DNS query reaches the threshold of the value specified here, the corresponding record will be deleted from router's Cache automatically. |

## IX-1-8 Ping Diagnosis

Click Diagnostics and click Ping Diagnosis to open the web page.

Diagnostics >> Ping Diagnosis

**Ping Diagnosis**

IPV4    IPV6  
 Ping through:    Source IP:   
 Ping to:    IP Address:

**Result** | [Clear](#) |

**Note:**

1. If you want to ping a LAN PC or you don't want to specify which WAN to ping through, please select "Auto" in Ping Through.
2. If you select "Auto" in Source IP, we will fill Source IP according to the interface you ping through.

or

Diagnostics >> Ping Diagnosis

**Ping Diagnosis**

IPV4    IPV6  
 Ping through:    Ping IPv6 Address:

**Result** | [Clear](#) |

**Note:**

1. If you want to ping a LAN PC or you don't want to specify which WAN to ping through, please select "Auto" in Ping Through.
2. If you select "Auto" in Source IP, we will fill Source IP according to the interface you ping through.

Available settings are explained as follows:

| Item         | Description                                                                                                                                       |
|--------------|---------------------------------------------------------------------------------------------------------------------------------------------------|
| IPV4 /IPV6   | Choose the interface for such function.                                                                                                           |
| Ping through | Use the drop down list to choose the WAN/LTE interface that you want to ping through or choose Auto to be determined by the router automatically. |



|                   |                                                                                       |
|-------------------|---------------------------------------------------------------------------------------|
| Ping to           | Use the drop down list to choose the destination that you want to ping.               |
| IP Address        | Enter the IP address of the Host/IP that you want to ping.                            |
| Ping IPv6 Address | Enter the IPv6 address that you want to ping.                                         |
| Run               | Click this button to start the ping work. The result will be displayed on the screen. |
| Clear             | Click this link to remove the result on the window.                                   |

## IX-1-9 Data Flow Monitor

This page displays the running procedure for the IP address monitored and refreshes the data in an interval of several seconds. The IP address listed here is configured in Bandwidth Management. You have to enable IP bandwidth limit and IP session limit before invoking Data Flow Monitor. If not, a notification dialog box will appear to remind you enabling it.

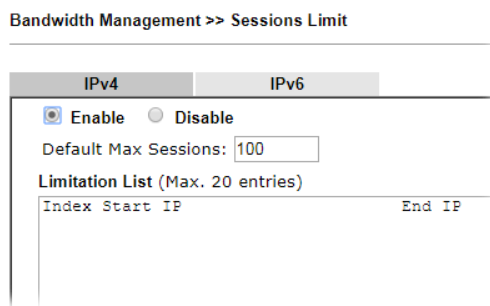

Click Diagnostics and click Data Flow Monitor to open the web page. You can click IP Address, TX rate, RX rate or Session link for arranging the data display.



|                     |                                                                                                                                                                                                                                                                                                             |
|---------------------|-------------------------------------------------------------------------------------------------------------------------------------------------------------------------------------------------------------------------------------------------------------------------------------------------------------|
| Current /Peak/Speed | Current means current transmission rate and receiving rate for WAN interface.<br>Peak means the highest peak value detected by the router in data transmission.<br>Speed means line speed specified in WAN>>General Setup. If you do not specify any rate at that page, here will display Auto for instead. |
|---------------------|-------------------------------------------------------------------------------------------------------------------------------------------------------------------------------------------------------------------------------------------------------------------------------------------------------------|

## IX-1-10 Traffic Graph

Click Diagnostics and click Traffic Graph to open the web page. Choose WAN1/WAN2/WAN3/WAN4/WAN5/WAN6 Bandwidth, Sessions, Ping Detect, daily or weekly for viewing different traffic graph. Click Reset to zero the accumulated RX/TX (received and transmitted) data of WAN. Click Refresh to renew the graph at any time.

Diagnostics >> Traffic Graph

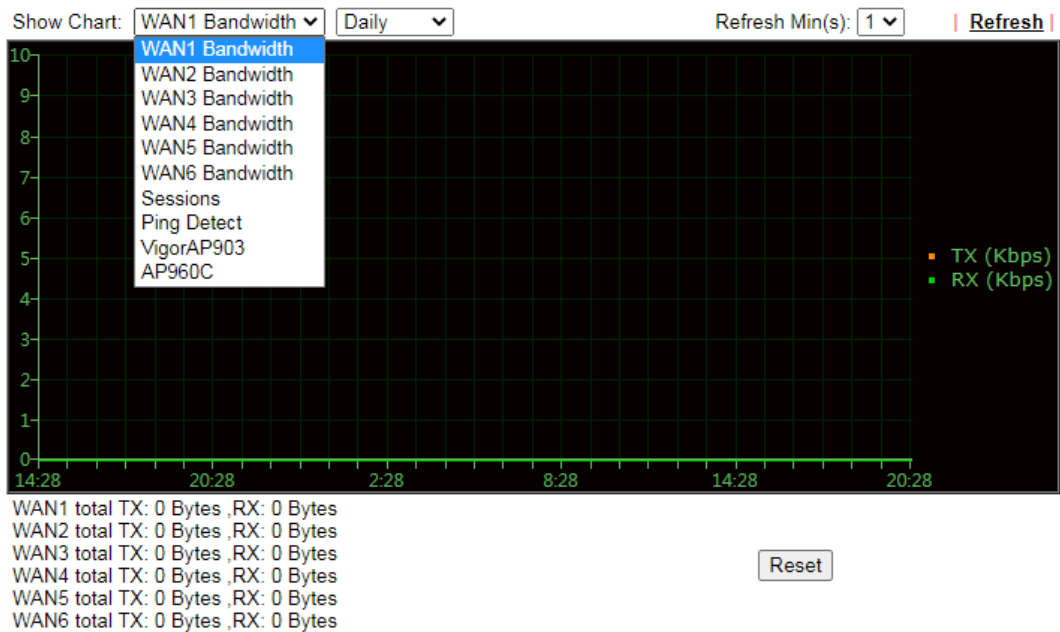

The horizontal axis represents time. Yet the vertical axis has different meanings. For WAN1/WAN2/WAN3/WAN4/WAN5/WAN6 Bandwidth chart, the numbers displayed on vertical axis represent the numbers of the transmitted and received packets in the past.

For Sessions chart, the numbers displayed on vertical axis represent the numbers of the NAT sessions during the past.

---

## IX-1-11 VPN Graph

Click Diagnostics and click VPN Graph to open the web page.

Diagnostics >> VPN Graph

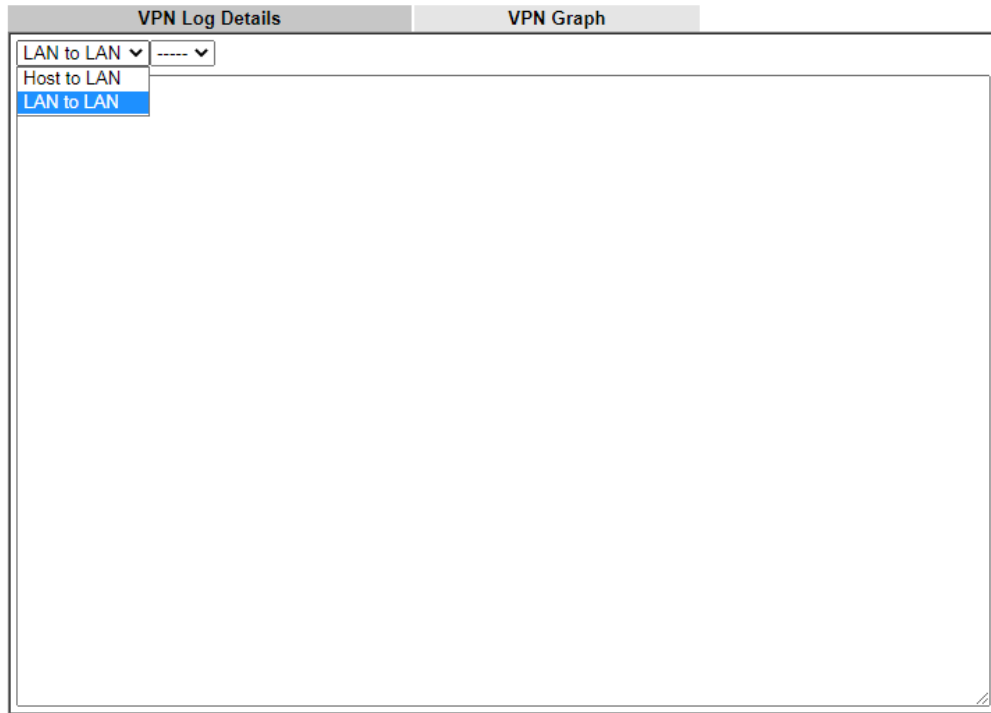

and

Diagnostics >> VPN Graph

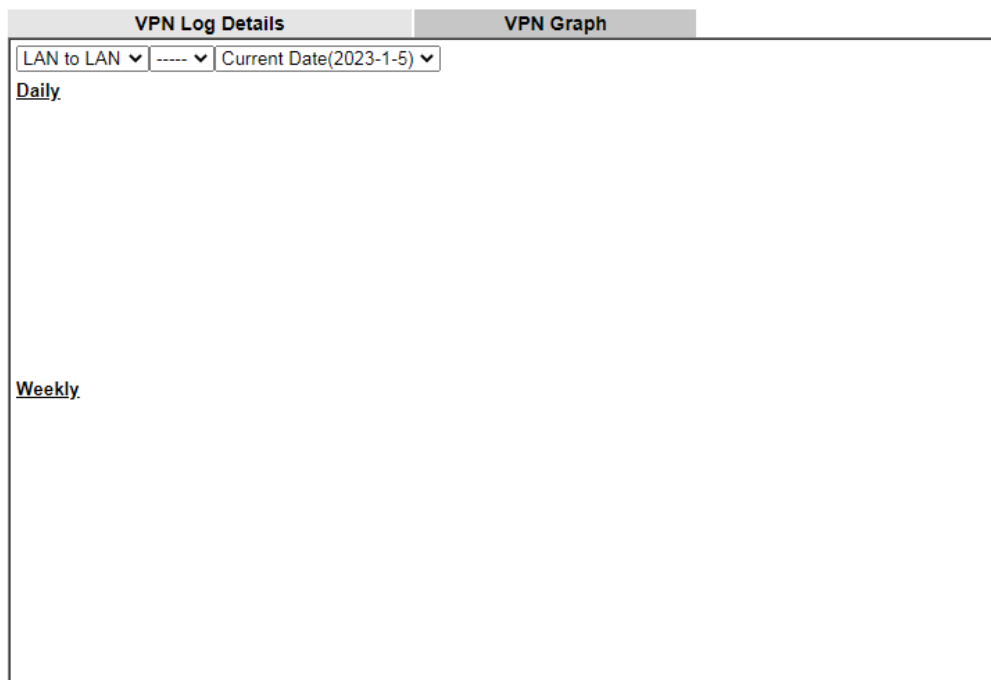

---

## IX-1-12 Trace Route

Click Diagnostics and click Trace Route to open the web page. This page allows you to trace the routes from router to the host. Simply Enter the IP address of the host in the box and click Run. The result of route trace will be shown on the screen.

Diagnostics >> Trace Route

---

### Trace Route

IPV4  IPV6

Trace through:

Protocol:

Host / IP Address:

**Result** | [Clear](#) |

or

Diagnostics >> Trace Route

---

### Trace Route

IPV4  IPV6

Trace Host / IP Address:

**Result** | [Clear](#) |

Available settings are explained as follows:

| Item          | Description                                                                   |
|---------------|-------------------------------------------------------------------------------|
| IPv4 / IPv6   | Click one of them to display corresponding information for it.                |
| Trace through | Use the drop down list to choose the interface that you want to ping through. |

|                       |                                                                              |
|-----------------------|------------------------------------------------------------------------------|
| Protocol              | Use the drop down list to choose the protocol that you want to ping through. |
| Host/IP Address       | It indicates the IP address of the host.                                     |
| Trace Host/IP Address | It indicates the IPv6 address of the host.                                   |
| Run                   | Click this button to start route tracing work.                               |
| Clear                 | Click this link to remove the result on the window.                          |

## IX-1-13 Syslog Explorer

Such page provides real-time syslog and displays the information on the screen.

### For Web Syslog

This page displays the time and message for User/Firewall/call/WAN/VPN settings. You can check Enable Web Syslog, specify the type of Syslog and choose the display mode you want. Later, the event of Syslog with specified type will be shown for your reference.

Diagnostics >> Syslog Explorer

| Web Syslog                                                                                                                                             | USB Syslog |
|--------------------------------------------------------------------------------------------------------------------------------------------------------|------------|
| <input type="checkbox"/> Enable Web Syslog <span style="float: right;"><a href="#">Export</a>   <a href="#">Refresh</a>   <a href="#">Clear</a></span> |            |
| Syslog Type <input type="text" value="User"/> Display Mode <input type="text" value="Stop record when full"/>                                          |            |
| Time                                                                                                                                                   | Message    |

Available settings are explained as follows:

| Item              | Description                                                                                                                                                                                                                                                                                                                                                                                                                                                                                                                                                  |
|-------------------|--------------------------------------------------------------------------------------------------------------------------------------------------------------------------------------------------------------------------------------------------------------------------------------------------------------------------------------------------------------------------------------------------------------------------------------------------------------------------------------------------------------------------------------------------------------|
| Enable Web Syslog | Check this box to enable the function of Web Syslog.                                                                                                                                                                                                                                                                                                                                                                                                                                                                                                         |
| Syslog Type       | Use the drop down list to specify a type of Syslog to be displayed.                                                                                                                                                                                                                                                                                                                                                                                                                                                                                          |
| Export            | Click this link to save the data as a file.                                                                                                                                                                                                                                                                                                                                                                                                                                                                                                                  |
| Refresh           | Click this link to refresh this page manually.                                                                                                                                                                                                                                                                                                                                                                                                                                                                                                               |
| Clear             | Click this link to clear information on this page.                                                                                                                                                                                                                                                                                                                                                                                                                                                                                                           |
| Display Mode      | There are two modes for you to choose. <div style="border: 1px solid gray; padding: 5px; margin: 10px 0;"> <input type="text" value="Stop record when full"/> <ul style="list-style-type: none"> <li style="background-color: #0070C0; color: white; padding: 2px;">Stop record when full</li> <li style="padding: 2px;">Always record the new event</li> </ul> </div> Stop record when fulls - When the capacity of syslog is full, the system will stop recording.<br>Always record the new event - only the newest events will be recorded by the system. |
| Time              | Display the time of the event occurred.                                                                                                                                                                                                                                                                                                                                                                                                                                                                                                                      |
| Message           | Display the information for each event.                                                                                                                                                                                                                                                                                                                                                                                                                                                                                                                      |

### For USB Syslog

This page displays the syslog recorded on the USB storage disk.

Diagnostics >> Syslog Explorer

| Web Syslog                                                | USB Syslog |               |
|-----------------------------------------------------------|------------|---------------|
| <b>Note:</b>                                              |            |               |
| The syslog will show while the saved syslog file is full. |            |               |
| File: n/a                                                 | Page: n/a  | Log Type: n/a |
| Time                                                      | Log Type   | Message       |

Available settings are explained as follows:

| Item     | Description                             |
|----------|-----------------------------------------|
| Time     | Display the time of the event occurred. |
| Log Type | Display the type of the record.         |
| Message  | Display the information for each event. |

## IX-1-14 IPv6 TSPC Status

IPv6 TSPC status web page could help you to diagnose the connection status of TSPC.

If TSPC has configured properly, the router will display the following page when the user connects to tunnel broker successfully.

Diagnostics >> IPv6 TSPC Status

| WAN1                                                                                                                                                                                                                                                                                                                                                                                                                                                                                                           | WAN2 | WAN3 | WAN4 | WAN5 | WAN6 | <a href="#">Refresh</a> |
|----------------------------------------------------------------------------------------------------------------------------------------------------------------------------------------------------------------------------------------------------------------------------------------------------------------------------------------------------------------------------------------------------------------------------------------------------------------------------------------------------------------|------|------|------|------|------|-------------------------|
| <b>TSPC Enabled</b><br><b>TSPC Connection Status</b><br>Local Endpoint v4 Address : 114.44.54.220<br>Local Endpoint v6 Address : 2001:05c0:1400:000b:0000:0000:0000:10b9<br>Router DNS name : 888866666.broker.freenet6.net<br>Remote Endpoint v4 Address : 81.171.72.11<br>Remote Endpoint v6 Address : 2001:05c0:1400:000b:0000:0000:0000:10b8<br>Tspc Prefix : 2001:05c0:1502:0d00:0000:0000:0000:0000<br>Tspc Prefixlen : 56<br>Tunnel Broker : amsterdam.freenet6.net<br>Tunnel Status : <b>Connected</b> |      |      |      |      |      |                         |

Available settings are explained as follows:

| Item    | Description                                    |
|---------|------------------------------------------------|
| Refresh | Click this link to refresh this page manually. |

## IX-1-15 High Availability Status

All of the routers under the same DARP (DrayTek Address resolution Protocol) group can be viewed in such page. However, only partial information of the router status will be displayed.

Vigor routers with the following conditions will be treated as the same DARP group:

- HA enabled



- the same Redundancy method
- the same Group ID
- the same Authentication Key
- the same Management Interface

Open Diagnostics>>High Availability Status.

Diagnostics >> High Availability Status

| Status | Router Name | IP          | Role    | Stable | WAN                 | Sync Status                               | Cached Time |
|--------|-------------|-------------|---------|--------|---------------------|-------------------------------------------|-------------|
| !      | DrayTek     | 192.168.1.1 | Primary | No     | All WANs Down - Eth | Ready <input type="button" value="Sync"/> | -           |

**Note:**

1. High Availability Status table displays 10 routers maximum. The local router will always show in the first row of this table.
2. A Status of "!" indicates that an error has occurred, refer to the [Details](#) page for more information.

Available settings are explained as follows:

| Item         | Description                                                                                                                                                                                                                                                                                                      |
|--------------|------------------------------------------------------------------------------------------------------------------------------------------------------------------------------------------------------------------------------------------------------------------------------------------------------------------|
| Details/Back | Details - Click it to display detailed status about HA configuration for the selected router.<br>Back - Return to previous page.                                                                                                                                                                                 |
| HA Setup     | Click it to open Applications>>High Availability for modifying the configuration.                                                                                                                                                                                                                                |
| Renew        | Click it to get the newest status of other router (except the primary router).                                                                                                                                                                                                                                   |
| Refresh      | Click it to get the newest status of the primary router.                                                                                                                                                                                                                                                         |
| Status       | "!" means an error has occurred. Refer to Detailed information and modify HA settings if required.                                                                                                                                                                                                               |
| Router Name  | Display the name of the device.                                                                                                                                                                                                                                                                                  |
| IP           | Display the IPv4 address of such router.                                                                                                                                                                                                                                                                         |
| Role         | "Down" means the function of HA is disabled.<br>"Primary" means such router stands for the primary router in HA.<br>"Secondary" means such router stands for the secondary router in HA.                                                                                                                         |
| Stable       | "No" means the primary router has not been determined yet. DARP is negotiating.<br>"YES" means the primary router is determined.                                                                                                                                                                                 |
| WAN          | "At Least One UP" means that at least one WAN interface connects to Internet.<br>"All WANs Down" means that no WAN interface connects to Internet.                                                                                                                                                               |
| Sync Status  | "Not Ready" means configuration synchronization is unable to execute, or configuration synchronization is disabled, or synchronization initialization executes but fails.<br>"Ready" means configuration synchronization is ready to execute.<br>"Progressing" means configuration synchronization is operating. |

|             |                                                                                                                                                                              |
|-------------|------------------------------------------------------------------------------------------------------------------------------------------------------------------------------|
|             | <p>“Fail” means configuration synchronization executed and failed; or wrong model name.</p> <p>“Equal” means the corresponding settings are equal to the primary router.</p> |
| Cached Time | Display the time period since the last time to get the newest status of other router (except the primary router).                                                            |

Click the link of Router Name, IP or Details, the following page will be displayed on the screen.

Diagnostics >> High Availability Status >> Details

[ Local Router ] | [Back](#) | [HA Setup](#) | [Renew](#) | [Refresh](#) |

| DrayTek                  |                   | 192.168.1.1 (FE80::D567:1F16:1B69:8B7C) |                                           |                        |
|--------------------------|-------------------|-----------------------------------------|-------------------------------------------|------------------------|
| Role                     | Stable            | WAN                                     | Sync Status                               | Cached Time            |
| Primary                  | No !              | All WANs Down - Eth !                   | Ready <input type="button" value="Sync"/> | -                      |
| Config Sync Status       |                   | Not Ready                               | DHCPv6 Sync Status                        | Ready                  |
| MAC                      | 00:1d:aa:00:00:00 |                                         | HTTPs Port                                | 443                    |
| Model                    | Vigor2865ac       |                                         | Firmware Version                          | 4.0.4_RC2_STD          |
| Enable High Availability | Off               | ! Redundancy Method                     | Active-Standby                            |                        |
| Group ID                 | 1                 |                                         | Priority ID                               | 10                     |
| Authentication Key       | draytek           |                                         | Management Interface                      | LAN1                   |
| Update DDNS              | Off               |                                         | Protocol                                  | IPv4                   |
| Virtual IPv4             | Off !             |                                         |                                           |                        |
| Virtual IPv6             | On                | LAN1                                    | FE80::200:5EFF:FE00:101                   |                        |
|                          |                   | LAN2                                    | FE80::200:5EFF:FE00:101                   |                        |
|                          |                   | LAN3                                    | FE80::200:5EFF:FE00:101                   |                        |
|                          |                   | LAN4                                    | FE80::200:5EFF:FE00:101                   |                        |
|                          |                   | LAN5                                    | FE80::200:5EFF:FE00:101                   |                        |
|                          |                   | LAN6                                    | FE80::200:5EFF:FE00:101                   |                        |
|                          |                   | LAN7                                    | FE80::200:5EFF:FE00:101                   |                        |
|                          |                   | LAN8                                    | FE80::200:5EFF:FE00:101                   |                        |
|                          |                   | DMZ                                     | FE80::200:5EFF:FE00:101                   |                        |
| Enable Config Sync       | Off               |                                         | Config Sync Interval                      | 0 Day 0 Hour 15 Minute |
| Last Config Sync By      | 00:00:00:00:00:00 |                                         |                                           |                        |

**Note:**

Displays up to 10 routers. Each router can show up to 9 Virtual IPs.

## IX-1-16 Authentication Information

### Authentication User List

Such page displays authentication jobs made by Internal RADIUS or Local 802.1X.

When the mouse cursor moves to the name link under User Name, the connection message (including authentication failed information) about internal RADIUS or local 802.1X service will be shown by a popped up dialog box.

Diagnostics >> Authentication Information

| Authentication User List |                              | Authentication Information Log |                                                 |
|--------------------------|------------------------------|--------------------------------|-------------------------------------------------|
|                          |                              |                                | <a href="#">Refresh</a>   <a href="#">Clear</a> |
| User Name                | Authentication Failure Times | User Name                      | Authentication Failure Times                    |
| test_1                   | 0                            | test_sales                     | 0                                               |

**Note:**

- 1.This is the authentication list for router's **Internal RADIUS** or Local 802.1X
- 2.For those clients are authenticated by external RADIUS server, please find the information from the server.

## Authentication Information Log

This page will display the complete authentication log information.

Diagnostics >> Authentication Information

| Authentication User List        |             | Authentication Information Log                       |                                                                       |
|---------------------------------|-------------|------------------------------------------------------|-----------------------------------------------------------------------|
| <input type="checkbox"/> Enable |             |                                                      | <a href="#">Refresh</a>   <a href="#">Clear</a>                       |
|                                 | Syslog Type | <input type="text" value="Radius"/>                  | Display Mode <input type="text" value="always record the new event"/> |
|                                 |             | <input type="text" value="Radius"/><br>802.1X<br>ALL |                                                                       |
|                                 | Time        |                                                      | Message                                                               |

Available settings are explained as follows:

| Item         | Description                                                                                                                                                                                                                                                                                                                            |
|--------------|----------------------------------------------------------------------------------------------------------------------------------------------------------------------------------------------------------------------------------------------------------------------------------------------------------------------------------------|
| Enable       | Check the box to enable such function.                                                                                                                                                                                                                                                                                                 |
| Refresh      | Click it to update current page.                                                                                                                                                                                                                                                                                                       |
| Clear        | Click it to remove all of the records.                                                                                                                                                                                                                                                                                                 |
| Syslog Type  | Specify RADIUS, 802.1X or All to display related authentication information log.                                                                                                                                                                                                                                                       |
| Display Mode | Choose the mode you want to display the related information on the following table. <ul style="list-style-type: none"> <li>● Stop record when fulls - When the capacity of CVM log is full, the system will stop recording.</li> <li>● Always record the new event - only the newest events will be recorded by the system.</li> </ul> |
| Time         | Display the time the user authenticated by Vigor2927 series.                                                                                                                                                                                                                                                                           |
| Message      | Display authentication information done by Vigor2927 series.                                                                                                                                                                                                                                                                           |

---

## IX-1-17 DoS Flood Table

This page can display content of IP connection detected by DoS Flooding Defense mechanism. It is useful and convenient for network engineers (e.g., MIS engineer) to inspect the network environment to find out if there is any abnormal connection.

Information of IP traced and destination port used for SYN Flood, UDP Flood and ICMP Flood attacks will be detected and shown respectively on different pages.

Moreover, IP address detected and suspected to attack the network system can be blocked shortly by clicking the Block button shown on pages of SYN Flood, UDP Flood and ICMP Flood.

Diagnostics >> DoS Flood Table

---

IPv4

| SYN Flood  | UDP Flood | ICMP Flood       | Refresh |
|------------|-----------|------------------|---------|
| Tracing IP |           | Destination Port |         |
| .....      |           |                  |         |

IPv6

| SYN Flood  | UDP Flood | ICMP Flood       | Refresh |
|------------|-----------|------------------|---------|
| Tracing IP |           | Destination Port |         |
| .....      |           |                  |         |

**Note:**

You need to enable SYN/UDP/ICMP flood defense in [Firewall >> Defense Setup](#) to make this table effective.



---

**Info**

The icon - (⊗) - means there is something wrong (e.g., attacking the system) with that IP address.

---

---

## IX-1-18 Route Policy Diagnosis

With the analysis done by such page, possible path (static route, routing table or policy route) of the packets sent out of the router can be traced.

Diagnostics >> Route Policy Diagnosis

---

Test how the packets will be routed

- Mode  Analyze a single packet  
 Analyze multiple packets by uploading an input file

Packet Information

|          |               |             |
|----------|---------------|-------------|
| Protocol | ICMP          |             |
| Src IP   | Specify an IP | 192.168.1.2 |
| Dst IP   | Specify an IP |             |
| Dst Port | Any Port      |             |

Analyze

or

Diagnostics >> Route Policy Diagnosis

---

Test how the packets will be routed

- Mode  Analyze a single packet  
 Analyze multiple packets by uploading an input file

Input File

選擇檔案 未選擇任何檔案

( [download](#) an example input file)

Analyze

Available settings are explained as follows:

| Item               | Description                                                                                                                                                                                                                                                                         |
|--------------------|-------------------------------------------------------------------------------------------------------------------------------------------------------------------------------------------------------------------------------------------------------------------------------------|
| Mode               | Analyze a single packet - Choose such mode to make Vigor router analyze how a single packet will be sent by a route policy.<br>Analyze multiple packets... - Choose such mode to make Vigor router analyze how multiple packets in a specified file will be sent by a route policy. |
| Packet Information | Specify the nature of the packets to be analyzed by Vigor router.<br>ICMP/UDP/TCP/ANY- Specify a protocol for diagnosis.<br>Src IP - Type an IP address as the source IP.                                                                                                           |

Dst IP - Type an IP address as the destination IP.  
 Dst Port - Use the drop down list to specify the destination port.  
 Analyze - Click it to perform the job of analyzing. The analyzed result will be shown on the page..

**Input File**

It is available when Analyze multiple packets.. is selected as Mode.  
 Select - Click the download link to get a blank example file. Then, click such button to select that blank “.csv” file for saving the result of analysis.



Analyze - Click it to perform the job of analyzing. The analyzed result will be shown on the page. If required, click export analysis to export the result as a file.

Load Balance/Route Policy >> Diagnose

Mode

analyze how a packet will be sent  
 analyze how multiple packets as specified in the input file will be sent

Input File

[選擇檔案](#) [未選擇檔案](#) (download an example input file)

Analysis [export analysis](#)

| Profile   | Input Packet Information |              |             |          | Matched Route |          | Matched Policy |          |               | Final Result |                                                                        |
|-----------|--------------------------|--------------|-------------|----------|---------------|----------|----------------|----------|---------------|--------------|------------------------------------------------------------------------|
|           | Proto                    | Src IP       | Dst IP      | Dst Port | Route         | Priority | Policy         | Priority | Is/overlapped | Interface    | Reason                                                                 |
| LA-branch | ICMP                     | 192.168.1.10 | 10.10.10.10 | N/A      | No Match      | N/A      | No Match       | N/A      | N/A           | N/A          | The packet was dropped because neither "route" or "policy" was matched |
| NY-branch | TCP                      | 192.168.1.20 | 20.20.20.20 | 5060     | No Match      | N/A      | No Match       | N/A      | N/A           | N/A          | The packet was dropped because neither "route" or "policy" was matched |
|           |                          |              |             |          |               |          |                |          |               |              | The packet was dropped because                                         |

Note that the analysis was based on the current "load-balance/route policy" settings, we do not guarantee it will be 100% the same as the real case.

---

## IX-2 Checking If the Hardware Status Is OK or Not

Follow the steps below to verify the hardware status.

1. Check the power line and WLAN/LAN cable connections. Refer to “I-2 Hardware Installation” for details.
2. Turn on the router. Make sure the ACT LED blink once per second and the correspondent LAN LED is bright.

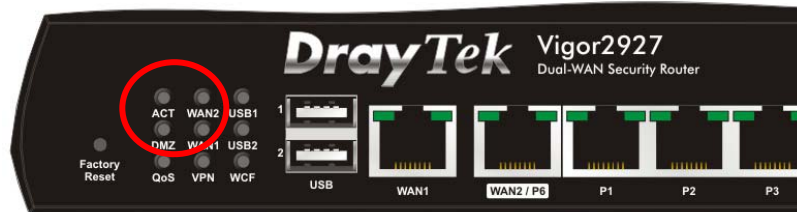

3. If not, it means that there is something wrong with the hardware status. Simply back to “I-2 Hardware Installation” to execute the hardware installation again. And then, try again.

---

## IX-3 Checking If the Network Connection Settings on Your Computer Is OK or Not

Sometimes the link failure occurs due to the wrong network connection settings. After trying the above section, if the link is still failed, please do the steps listed below to make sure the network connection settings is OK.

### For Windows



#### Info

The example is based on Windows 7. As to the examples for other operation systems, please refer to the similar steps or find support notes in [www.DrayTek.com](http://www.DrayTek.com).

1. Open All Programs>>Getting Started>>Control Panel. Click Network and Sharing Center.



2. In the following window, click Change adapter settings.

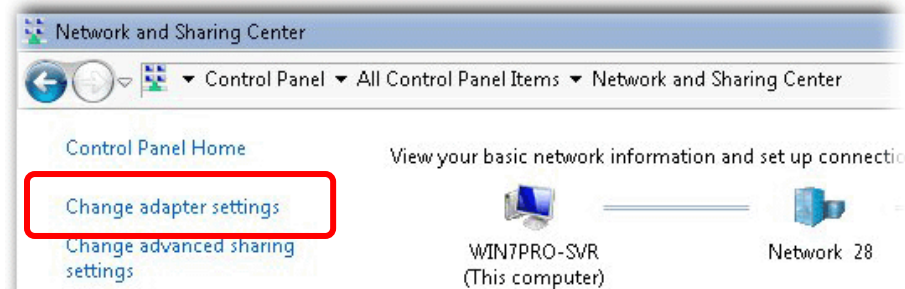

3. Icons of network connection will be shown on the window. Right-click on Local Area Connection and click on Properties.

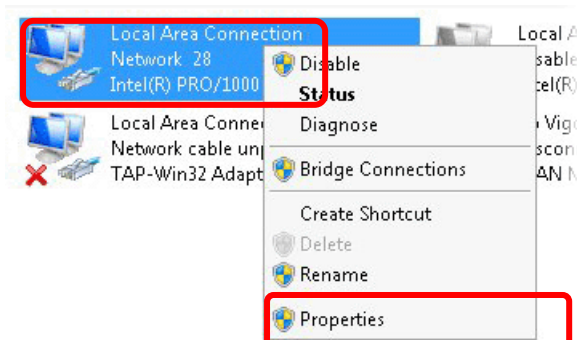



4. Select Internet Protocol Version 4 (TCP/IP) and then click Properties.

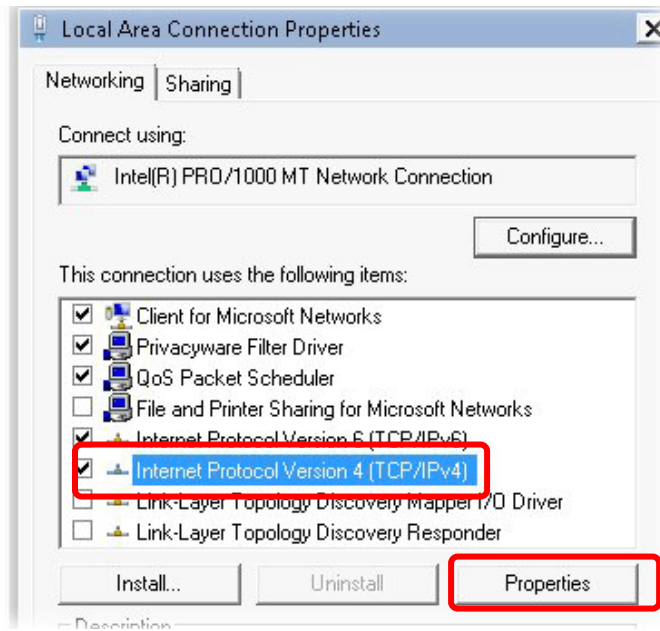

5. Select Obtain an IP address automatically and Obtain DNS server address automatically. Finally, click OK.

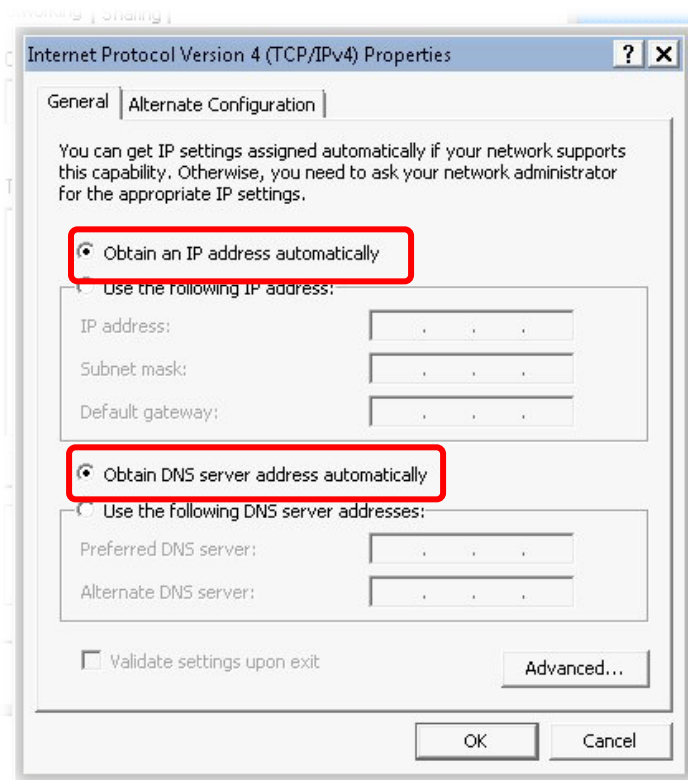

## For Mac OS

1. Double click on the current used Mac OS on the desktop.
2. Open the Application folder and get into Network.
3. On the Network screen, select Using DHCP from the drop down list of Configure IPv4.

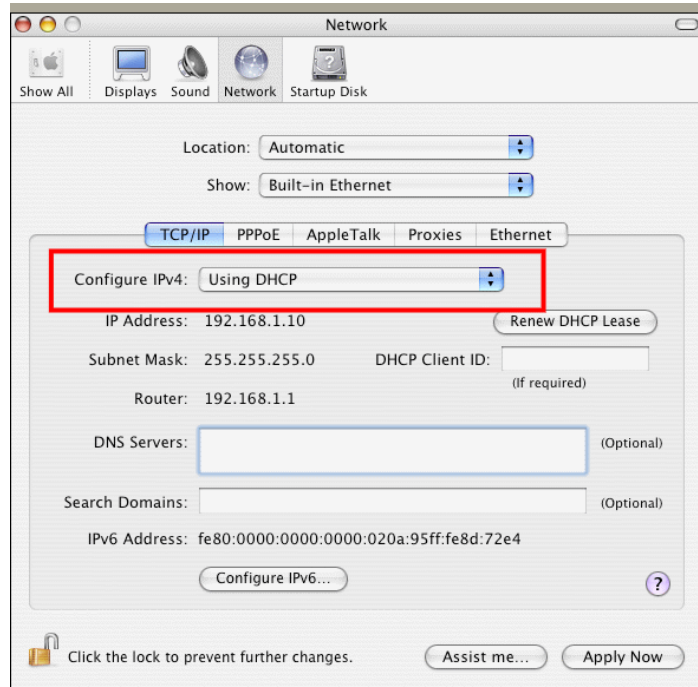

---

## IX-4 Pinging the Router from Your Computer

The default gateway IP address of the router is 192.168.1.1. For some reason, you might need to use “ping” command to check the link status of the router. The most important thing is that the computer will receive a reply from 192.168.1.1. If not, please check the IP address of your computer. We suggest you setting the network connection as get IP automatically. (Please refer to the previous section IX-3)

Please follow the steps below to ping the router correctly.

### For Windows

1. Open the Command Prompt window (from Start menu> Run).
2. Type cmd (for Windows 7/8/10/11). The DOS command dialog will appear.

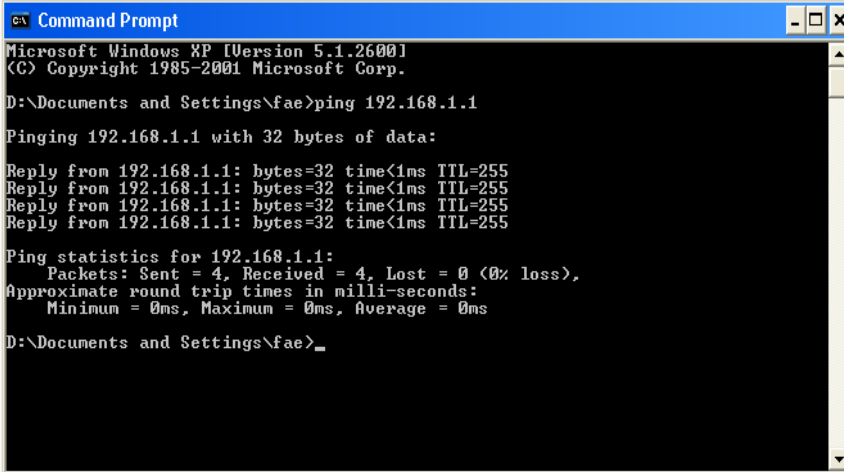

```
ca Command Prompt
Microsoft Windows XP [Version 5.1.2600]
(C) Copyright 1985-2001 Microsoft Corp.
D:\Documents and Settings\fae>ping 192.168.1.1
Pinging 192.168.1.1 with 32 bytes of data:
Reply from 192.168.1.1: bytes=32 time<1ms TTL=255
Reply from 192.168.1.1: bytes=32 time<1ms TTL=255
Reply from 192.168.1.1: bytes=32 time<1ms TTL=255
Reply from 192.168.1.1: bytes=32 time<1ms TTL=255
Ping statistics for 192.168.1.1:
    Packets: Sent = 4, Received = 4, Lost = 0 (0% loss),
    Approximate round trip times in milli-seconds:
        Minimum = 0ms, Maximum = 0ms, Average = 0ms
D:\Documents and Settings\fae>_
```

3. Type ping 192.168.1.1 and press [Enter]. If the link is OK, the line of “Reply from 192.168.1.1:bytes=32 time<1ms TTL=255” will appear.
4. If the line does not appear, please check the IP address setting of your computer.

### For Mac OS (Terminal)

1. Double click on the current used MacOs on the desktop.
2. Open the Application folder and get into Utilities.
3. Double click Terminal. The Terminal window will appear.
4. Type ping 192.168.1.1 and press [Enter]. If the link is OK, the line of “64 bytes from 192.168.1.1: icmp\_seq=0 ttl=255 time=xxxx ms” will appear.

```
Terminal — bash — 80x24
Last login: Sat Jan  3 02:24:18 on ttty1
Welcome to Darwin!
Vigor10:~ draytek$ ping 192.168.1.1
PING 192.168.1.1 (192.168.1.1): 56 data bytes
64 bytes from 192.168.1.1: icmp_seq=0 ttl=255 time=0.755 ms
64 bytes from 192.168.1.1: icmp_seq=1 ttl=255 time=0.697 ms
64 bytes from 192.168.1.1: icmp_seq=2 ttl=255 time=0.716 ms
64 bytes from 192.168.1.1: icmp_seq=3 ttl=255 time=0.731 ms
64 bytes from 192.168.1.1: icmp_seq=4 ttl=255 time=0.72 ms
^C
--- 192.168.1.1 ping statistics ---
5 packets transmitted, 5 packets received, 0% packet loss
round-trip min/avg/max = 0.697/0.723/0.755 ms
Vigor10:~ draytek$ █
```

---

## IX-5 Checking If the ISP Settings are OK or Not

If WAN connection cannot be up, check if the LEDs (according to the LED explanations listed on section I-1-1, Indicators and Connectors) are correct or not. If the LEDs are off, please:

- Change the Physical Type from Auto negotiation to other values (e.g., 100M full duplex).
- Next, change the physical type of modem (e.g., DSL/FTTX(GPON)/Cable modem) offered by ISP with the same value configured in Vigor router. Check if the LEDs on Vigor router are on or not.
- If not, please install an additional switch for connecting both Vigor router and the modem offered by ISP. Then, check if the LEDs on Vigor router are on or not.
- If the problem of LEDs cannot be solved by the above measures, please contact with the nearest reseller, or send an e-mail to DrayTek FAE for technical support.
- Check if the settings offered by ISP are configured well or not.

When the LEDs are on and correct, yet the WAN connection still cannot be up, please:

- Open WAN >> Internet Access page and then check whether the ISP settings are set correctly. Click Details Page of WAN1~WAN6 to review the settings that you configured previously.

WAN >> Internet Access

### Internet Access

| Index | Display Name | Physical Mode | Access Mode          |              |      |
|-------|--------------|---------------|----------------------|--------------|------|
| WAN1  |              | Ethernet      | Static or Dynamic IP | Details Page | IPv6 |
| WAN2  |              | Ethernet      | Static or Dynamic IP | Details Page | IPv6 |
| WAN3  |              | Wireless 2.4G | None                 | Details Page | IPv6 |
| WAN4  |              | Wireless 5G   | None                 | Details Page | IPv6 |
| LTE   |              | USB           | None                 | Details Page | IPv6 |
| WAN6  |              | USB           | None                 | Details Page | IPv6 |

#### Note:

1. Device on USB port 2 applies WAN6 configuration.

DHCP Client Option

## IX-6 Problems for 3G/4G Network Connection

When you have trouble in using 3G/4G network transmission, please check the following:

### Check if USB LED lights on or off

You have to wait about 15 seconds after inserting 3G/4G USB Modem into your Vigor2927. Later, the USB LED will light on which means the installation of USB Modem is successful. If the USB LED does not light on, please remove and reinsert the modem again. If it still fails, restart Vigor2927.

### USB LED lights on but the network connection does not work

Check the PIN Code of SIM card is disabled or not. Please use the utility of 3G/4G USB Modem to disable PIN code and try again. If it still fails, it might be the compliance problem of system. Please open DrayTek Syslog Tool to capture the connection information (WAN Log) and send the page (similar to the following graphic) to the service center of DrayTek.

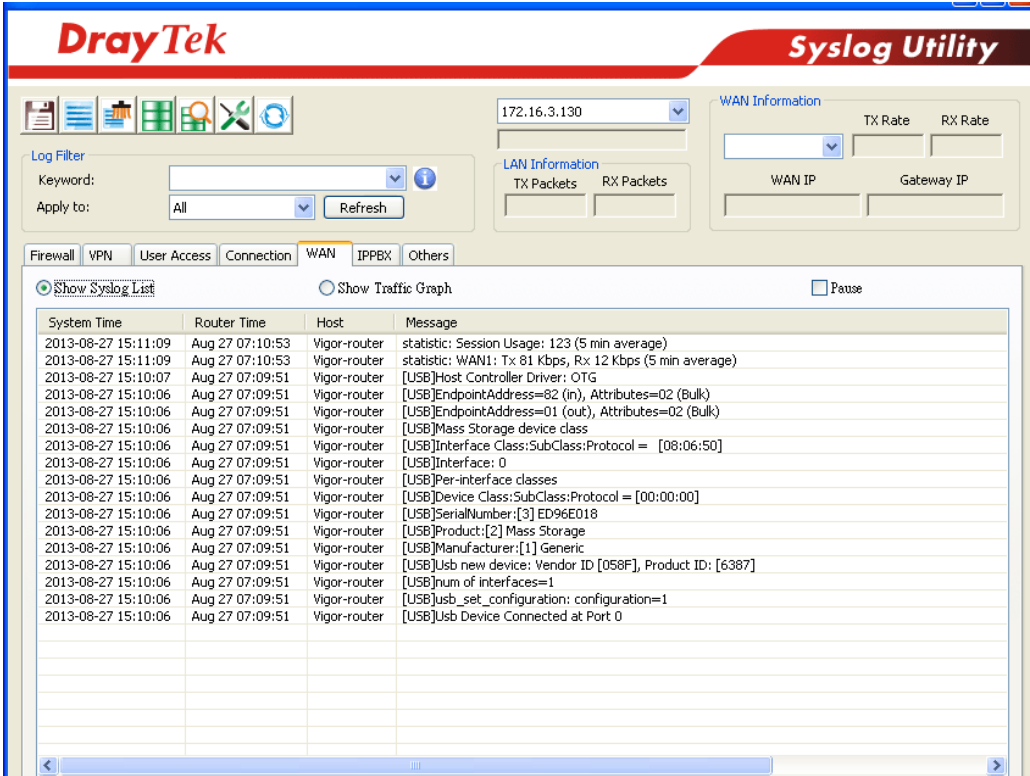

The screenshot displays the DrayTek Syslog Utility interface. At the top, there is a navigation bar with the DrayTek logo and the title 'Syslog Utility'. Below this, there are several sections: a 'Log Filter' section with a 'Keyword' field and an 'Apply to' dropdown set to 'All'; a 'WAN Information' section with a dropdown menu showing '172.16.3.130' and fields for 'TX Rate' and 'RX Rate'; and a 'LAN Information' section with fields for 'TX Packets' and 'RX Packets'. Below these sections are tabs for 'Firewall', 'VPN', 'User Access', 'Connection', 'WAN', 'IPPEX', and 'Others', with 'WAN' currently selected. The main area shows a 'Show Syslog List' section with a 'Show Traffic Graph' option and a 'Pause' checkbox. A table displays the following data:

| System Time         | Router Time     | Host         | Message                                                   |
|---------------------|-----------------|--------------|-----------------------------------------------------------|
| 2013-08-27 15:11:09 | Aug 27 07:10:53 | Vigor-router | statistic: Session Usage: 123 (5 min average)             |
| 2013-08-27 15:11:09 | Aug 27 07:10:53 | Vigor-router | statistic: WAN1: Tx 81 Kbps, Rx 12 Kbps (5 min average)   |
| 2013-08-27 15:10:07 | Aug 27 07:09:51 | Vigor-router | [USB]Host Controller Driver: OTG                          |
| 2013-08-27 15:10:06 | Aug 27 07:09:51 | Vigor-router | [USB]EndpointAddress=82 (in), Attributes=02 (Bulk)        |
| 2013-08-27 15:10:06 | Aug 27 07:09:51 | Vigor-router | [USB]EndpointAddress=01 (out), Attributes=02 (Bulk)       |
| 2013-08-27 15:10:06 | Aug 27 07:09:51 | Vigor-router | [USB]Mass Storage device class                            |
| 2013-08-27 15:10:06 | Aug 27 07:09:51 | Vigor-router | [USB]Interface Class:SubClass:Protocol = [08:06:50]       |
| 2013-08-27 15:10:06 | Aug 27 07:09:51 | Vigor-router | [USB]Interface: 0                                         |
| 2013-08-27 15:10:06 | Aug 27 07:09:51 | Vigor-router | [USB]Per-interface classes                                |
| 2013-08-27 15:10:06 | Aug 27 07:09:51 | Vigor-router | [USB]Device Class:SubClass:Protocol = [00:00:00]          |
| 2013-08-27 15:10:06 | Aug 27 07:09:51 | Vigor-router | [USB]SerialNumber:[3] ED96E018                            |
| 2013-08-27 15:10:06 | Aug 27 07:09:51 | Vigor-router | [USB]Product:[2] Mass Storage                             |
| 2013-08-27 15:10:06 | Aug 27 07:09:51 | Vigor-router | [USB]Manufacturer:[1] Generic                             |
| 2013-08-27 15:10:06 | Aug 27 07:09:51 | Vigor-router | [USB]usb new device: Vendor ID [058F], Product ID: [6387] |
| 2013-08-27 15:10:06 | Aug 27 07:09:51 | Vigor-router | [USB]num of interfaces=1                                  |
| 2013-08-27 15:10:06 | Aug 27 07:09:51 | Vigor-router | [USB]usb_set_configuration=1                              |
| 2013-08-27 15:10:06 | Aug 27 07:09:51 | Vigor-router | [USB]usb Device Connected at Port 0                       |

### Transmission Rate is not fast enough

Please connect your Notebook with 3G/4G USB Modem to test the connection speed to verify if the problem is caused by Vigor2927. In addition, please refer to the manual of 3G/4G USB Modem for LED Status to make sure if the modem connects to Internet via HSDPA mode. If you want to use the modem indoors, please put it on the place near the window to obtain better signal receiving.

---

## IX-7 Backing to Factory Default Setting If Necessary

Sometimes, a wrong connection can be improved by returning to the default settings. Try to reset the router by software or hardware. Such function is available in Admin Mode only.



### Info

After pressing factory default setting, you will lose all settings you did before. Make sure you have recorded all useful settings before you pressing. The password of factory default is null.

### Software Reset

You can reset the router to factory default via Web page. Such function is available in Admin Mode only.

Go to System Maintenance and choose Reboot System on the web page. The following screen will appear. Choose Using factory default configuration and click Reboot Now. After few seconds, the router will return all the settings to the factory settings.

System Maintenance >> Reboot System

#### Reboot System

Do you want to reboot your router ?

- Using current configuration  
 Using factory default configuration

Reboot Now

#### Auto Reboot Time Schedule

Schedule Profile :  ,  ,  ,

**Note:**

Action and Duration Time settings will be ignored.

OK

Cancel

### Hardware Reset

While the router is running (ACT LED blinking), press the Factory Reset button and hold for more than 5 seconds. When you see the ACT LED blinks rapidly, please release the button. Then, the router will restart with the default configuration.



After restore the factory default setting, you can configure the settings for the router again to fit your personal request.

---

## IX-8 Contacting DrayTek

If the router still cannot work correctly after trying many efforts, please contact your dealer for further help right away. For any questions, please feel free to send e-mail to [support@DrayTek.com](mailto:support@DrayTek.com).



# Part X Telnet Commands

---

## Accessing Telnet of Vigor2927

This chapter also gives you a general description for accessing telnet and describes the firmware versions for the routers explained in this manual.



### Info

For Windows 7 user, please make sure the Windows Features of Telnet Client has been turned on under Control Panel>>Programs.

Type cmd and press Enter. The Telnet terminal will be open later.

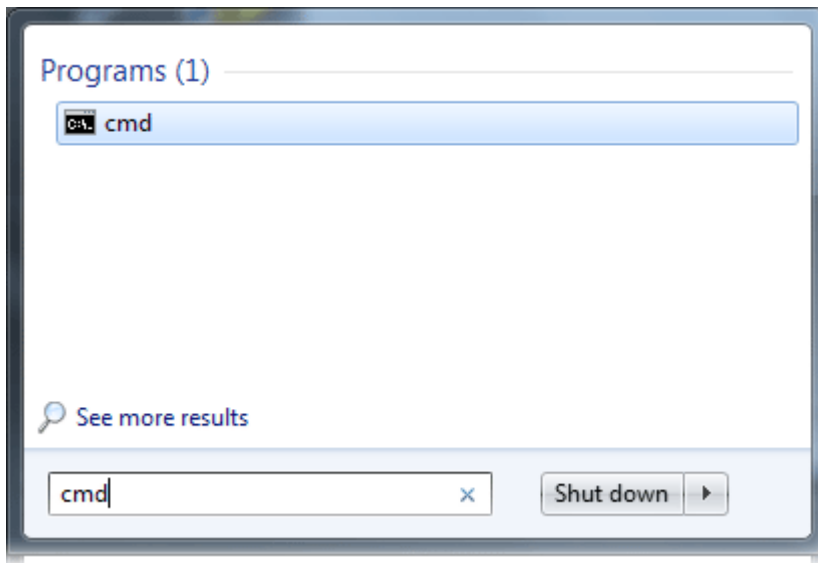

In the following window, type Telnet 192.168.1.1 as below and press Enter. Note that the IP address in the example is the default address of the router. If you have changed the default, enter the current IP address of the router.

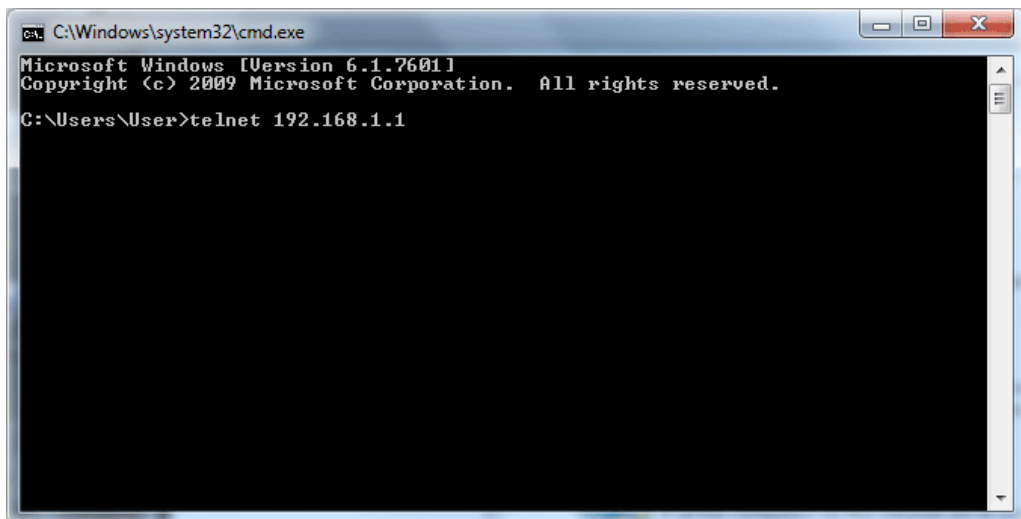

Next, enter admin/admin for Account/Password. Then, enter ?. You will see a list of valid/common commands depending on the router that your use.

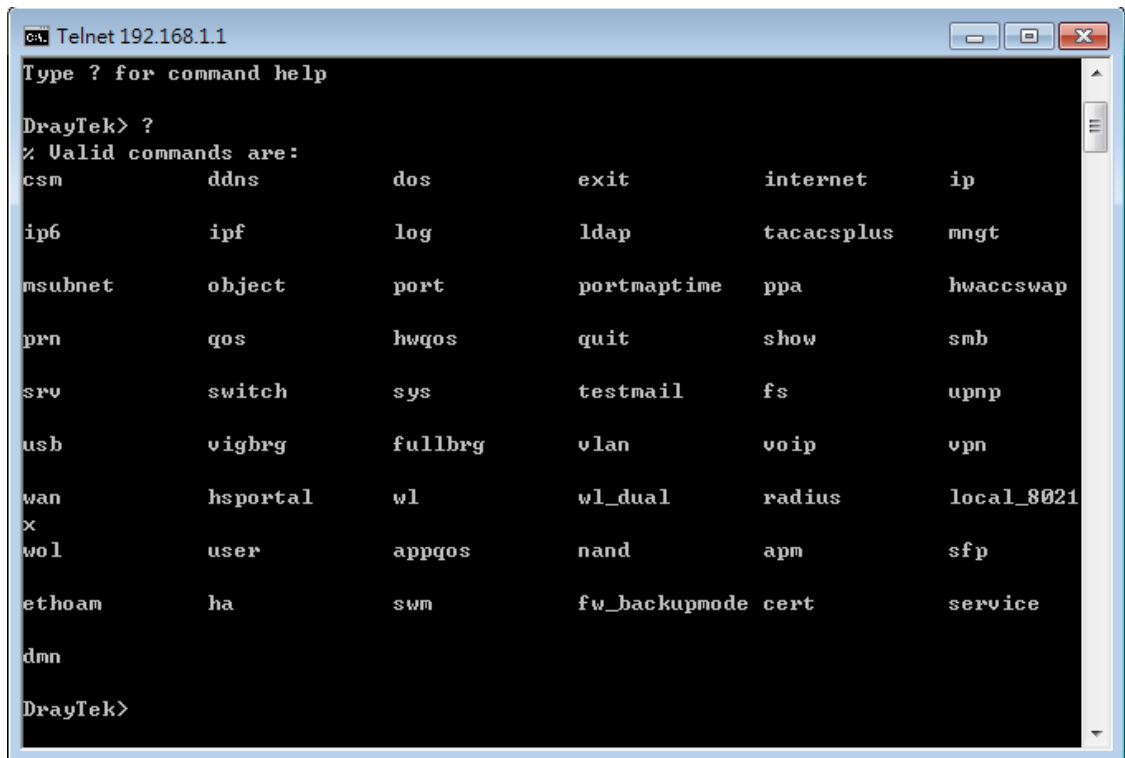

For users using previous Windows system (e.g., 2000/XP), simply click Start >> Run and type Telnet 192.168.1.1 in the Open box as below. Next, type admin/admin for Account/Password. And, type ? to get a list of valid/common commands.

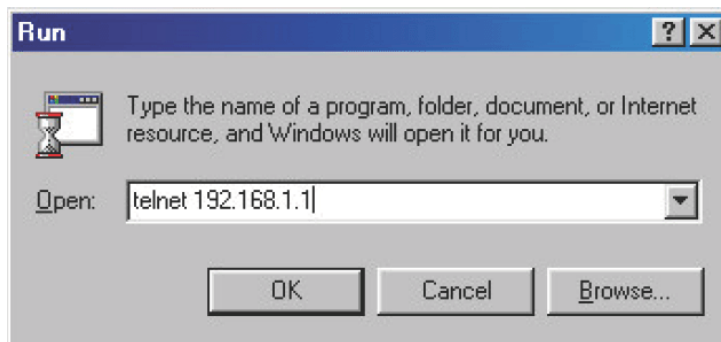

## Telnet Command: csm appe prof

Commands under CSM allow you to set CSM profile to define policy profiles for different policy of IM (Instant Messenger)/P2P (Peer to Peer) application.

“csm appe prof “ is used to configure the APP Enforcement Profile name. Such profile will be applied in Default Rule of Firewall>>General Setup for filtering.

### Syntax

```
csm appe prof -i INDEX [-v | -n NAME|setdefault]
```

### Syntax Description

| Parameter         | Description                                                              |
|-------------------|--------------------------------------------------------------------------|
| <i>INDEX</i>      | It means to specify the index number of CSM profile, from 1 to 32.       |
| -v                | It means to view the configuration of the CSM profile.                   |
| -n                | It means to set a name for the CSM profile.                              |
| <i>NAME</i>       | It means to specify a name for the CSM profile, less than 15 characters. |
| <i>setdefault</i> | Reset to default settings.                                               |

### Example

```
> csm appe prof -i 1 -n games
The name of APPE Profile 1 was setted.
```

## Telnet Command: csm appe set

It is used to configure group settings for IM/P2P/Protocol and Others in APP Enforcement Profile.

### Syntax

```
csm appe set -i INDEX -v GROUP
```

```
csm appe set -i INDEX -e AP_IDX
```

```
csm appe set -i INDEX -d AP_IDX
```

```
csm appe set -i INDEX -p AP_IDX
```

```
csm appe set -i INDEX -q AP_IDX
```

### Syntax Description

| Parameter        | Description                                                                                                                                                                    |
|------------------|--------------------------------------------------------------------------------------------------------------------------------------------------------------------------------|
| <i>INDEX</i>     | Specify the index number of CSM profile, from 1 to 32.                                                                                                                         |
| -v <i>GROUP</i>  | View the IM/P2P/Protocol and Others configuration of the CSM profile.<br>GROUP - Specify the category of the application. Available options are: IM, P2P, Protocol and Others. |
| -e <i>AP_IDX</i> | Enable to block specific application.<br>AP_IDX - Specify the index number of the APP.                                                                                         |
| -d <i>AP_IDX</i> | Disable to block specific application.<br>AP_IDX - Specify the index number of the APP.                                                                                        |
| -p <i>AP_IDX</i> | Enable the policy route for the action of specific application.                                                                                                                |

|           |                                                                                                                                                                                                                                                                                                                                                     |
|-----------|-----------------------------------------------------------------------------------------------------------------------------------------------------------------------------------------------------------------------------------------------------------------------------------------------------------------------------------------------------|
|           | AP_IDX - Specify the index number of the APP.                                                                                                                                                                                                                                                                                                       |
| -q AP_IDX | Disable the policy route for the action of specific application.<br>AP_IDX - Specify the index number of the APP.                                                                                                                                                                                                                                   |
| AP_IDX    | Each application has independent index number for identification in CLI command.<br>Specify the index number of the application here. If you have no idea of the index number, do the following (Take IM as an example):<br>Type "csm appe set -l 1 -v IM", the system will list all of the index numbers of the applications categorized under IM. |

### Example

```
> csm appe set -i 1 -p 1
The index of APP is not support for Policy Route!
>
```

### Telnet Command: csm appe show

It is used to display group (IM/P2P/Protocol and Others) information APP Enforcement Profile.

### Syntax

csm appe show [-a/-i/-p/-t/-m]

### Syntax Description

| Parameter | Description                                      |
|-----------|--------------------------------------------------|
| -a        | View the configuration status for All groups.    |
| -i        | View the configuration status of IM group.       |
| -p        | View the configuration status of P2P group.      |
| -t        | View the configuration status of protocol group. |
| -m        | View the configuration status of Others group.   |

### Example

```
> csm appe show -t
      Type      Index      Name      Version
-----
Protocol      43      BGP      4
Protocol      44      DNS
Protocol      45      FTP
Protocol      46      GIT
Protocol      47      H.323
Protocol      48      HTTP      1.1
Protocol      49      IBM Informix
Protocol      50      IBM DB2
Protocol      51      ICMP
Protocol      52      IMAP/IMAP STARTTLS      4.1
Protocol      53      IRC      2.4.0
Protocol      54      Microsoft SQL
Protocol      55      MQTT
```

|                                                                    |    |            |          |
|--------------------------------------------------------------------|----|------------|----------|
| Protocol                                                           | 56 | MySQL      |          |
| Protocol                                                           | 57 | NNTP       |          |
| Protocol                                                           | 58 | NNTPS      |          |
| Protocol                                                           | 59 | NTP        |          |
| Protocol                                                           | 60 | Oracle     | 11g      |
| Protocol                                                           | 61 | POP3/POP3  | STARTTLS |
| Protocol                                                           | 62 | PostgreSQL |          |
| Protocol                                                           | 63 | QUIC       | Q025     |
| --- MORE --- [q: Quit, 'Enter': New Lines, 'Space Bar': Next Page] |    |            |          |

## Telnet Command: csm appe config

It is used to display the configuration status (enabled or disabled) for IM/P2P/Protocol/Other applications.

### Syntax

`csm appe config -v INDEX [-i|-p|-t|-m]`

### Syntax Description

| Parameter    | Description                                            |
|--------------|--------------------------------------------------------|
| <i>INDEX</i> | Specify the index number of CSM profile, from 1 to 32. |
| <i>-i</i>    | View the configuration status of IM group.             |
| <i>-p</i>    | View the configuration status of P2P group.            |
| <i>-t</i>    | View the configuration status of protocol group.       |
| <i>-m</i>    | View the configuration status of Others group.         |

### Example

```
> csm appe config -v 1 -m
```

| Group  | Type      | Index | Name            | Enable  |
|--------|-----------|-------|-----------------|---------|
| OTHERS | Tunneling | 74    | CloudFlare      | Disable |
| OTHERS | Tunneling | 75    | DNSEncrypt      | Disable |
| OTHERS | Tunneling | 76    | DynaPass        | Disable |
| OTHERS | Tunneling | 77    | FreeGate        | Disable |
| OTHERS | Tunneling | 78    | Hotspot Shield  | Disable |
| OTHERS | Tunneling | 79    | HTTP Tunnel     | Disable |
| OTHERS | Tunneling | 80    | HTTP Proxy      | Disable |
| OTHERS | Tunneling | 81    | LogMeIn Hamachi | Disable |
| OTHERS | Tunneling | 82    | MS Teredo       | Disable |
| OTHERS | Tunneling | 83    | OpenDNS         | Disable |
| OTHERS | Tunneling | 84    | OpenVPN         | Disable |
| OTHERS | Tunneling | 85    | PGPNet          | Disable |
| OTHERS | Tunneling | 86    | Ping Tunnel     | Disable |
| OTHERS | Tunneling | 87    | RealTunnel      | Disable |
| OTHERS | Tunneling | 88    | Skyfire         | Disable |
| OTHERS | Tunneling | 89    | SOCKS4/SOCKS5   | Disable |
| OTHERS | Tunneling | 90    | SoftEther VPN   | Disable |
| OTHERS | Tunneling | 91    | TinyVPN         | Disable |
| OTHERS | Tunneling | 92    | Tor             | Disable |
| OTHERS | Tunneling | 93    | UltraVPN        | Disable |
| OTHERS | Tunneling | 94    | VNN             | Disable |

```

OTHERS      Tunneling      95      Wujie/UltraSurf      Disable
--- MORE ---  ['q': Quit, 'Enter': New Lines, 'Space Bar': Next Page] --
>

```

## Telnet Command: csm appe interface

It is used to configure APPE signature download interface.

### Syntax

csm appe interface <AUTO/WAN#>

### Syntax Description

| Parameter   | Description                                          |
|-------------|------------------------------------------------------|
| <i>AUTO</i> | Vigor router specifies WAN interface automatically.  |
| <i>WAN</i>  | Specify the WAN interface for signature downloading. |

### Example

```

> csm appe interface wan1
Download interface is set as "WAN1" now.
> csm appe interface auto
Download interface is set as "auto-selected" now.

```

## Telnet Command: csm appe email

It is used to set notification e-mail for APPE signature based on the settings configured in System Maintenance>>SysLog/Mail Alert Setup (in which, the box of APPE Signature is checked under Enable E-Mail Alert).

### Syntax

csm appe email <-e/-d/-s>

### Syntax Description

| Parameter | Description                            |
|-----------|----------------------------------------|
| <i>-e</i> | Enable notification e-mail mechanism.  |
| <i>-d</i> | Disable notification e-mail mechanism. |
| <i>-s</i> | Send an example e-mail.                |

### Example

```

> csm appe email -e
Enable APPE email.

```

## Telnet Command: csm ucf

It is used to configure settings for URL control filter profile.

### Syntax

csm ucf show  
csm ucf setdefault

```

csm ucf msg MSG
csm ucf obj INDEX <-n PROFILE_NAME | -l [P/B/A] | uac | wf >
csm ucf obj INDEX -n PROFILE_NAME
csm ucf obj INDEX -p VALUE
csm ucf obj INDEX -l P/B/A
csm ucf obj INDEX uac
csm ucf obj INDEX wf

```

## Syntax Description

| Parameter           | Description                                                                                                                                                                                         |
|---------------------|-----------------------------------------------------------------------------------------------------------------------------------------------------------------------------------------------------|
| <i>show</i>         | It means to display all of the profiles.                                                                                                                                                            |
| <i>setdefault</i>   | It means to return to default settings for all of the profile.                                                                                                                                      |
| <i>msg MSG</i>      | It means de set the administration message.<br>MSG means the content (less than 255 characters) of the message itself.                                                                              |
| <i>obj</i>          | It means to specify the object for the profile.                                                                                                                                                     |
| <i>INDEX</i>        | It means to specify the index number of CSM profile, from 1 to 8.                                                                                                                                   |
| <i>-n</i>           | It means to set the profile name.                                                                                                                                                                   |
| <i>PROFILE_NAME</i> | It means to specify the name of the profile (less than 16 characters)                                                                                                                               |
| <i>-p</i>           | Set the priority (defined by the number specified in VALUE) for the profile.                                                                                                                        |
| <i>VALUE</i>        | Number 0 to 3 represent different conditions.<br>0: It means Bundle: Pass.<br>1: It means Bundle: Block.<br>2: It means Either: URL Access Control First.<br>3: It means Either: Web Feature First. |
| <i>-l</i>           | It means the log type of the profile. They are:<br>P: Pass,<br>B: Block,<br>A: All,                                                                                                                 |
| <i>MSG</i>          | It means to specify the Administration Message, less then 255 characters                                                                                                                            |
| <i>uac</i>          | It means to set URL Access Control part.                                                                                                                                                            |
| <i>wf</i>           | It means to set Web Feature part.                                                                                                                                                                   |

## Example

```

> csm ucf obj 1 -n game -l B
Profile Index: 1 Profile Name:[game]
> csm ucf show
URL Content Filter Profile Table:
Profile      Name      Profile      Name
-----
[1]    [game    ] [5]    [
[2]    [        ] [6]    [
[3]    [        ] [7]    [
[4]    [        ] [8]    [
-----

```



```
Administration Message (Max 255 characters):
-----
<body><center><br><p>The requested Web page has been blocked by URL Content
Filt
er.<p>Please contact your system administrator for further
information.</center>
</body>
```

## Telnet Command: csm ucf obj INDEX uac

It means to configure the settings regarding to URL Access Control (uac).

### Syntax

```
csm ucf obj INDEX uac -v
csm ucf obj INDEX uac -e
csm ucf obj INDEX uac -d
csm ucf obj INDEX uac -a P|B
csm ucf obj INDEX uac -i E|D
csm ucf obj INDEX uac -o KEY_WORD_Object_Index
csm ucf obj INDEX uac -g KEY_WORD_Group_Index
```

### Syntax Description

| Parameter                    | Description                                                                                                                                                                                       |
|------------------------------|---------------------------------------------------------------------------------------------------------------------------------------------------------------------------------------------------|
| <i>INDEX</i>                 | It means to specify the index number of CSM profile, from 1 to 8.                                                                                                                                 |
| -v                           | It means to view the protocol configuration of the CSM profile.                                                                                                                                   |
| -e                           | It means to enable the function of URL Access Control.                                                                                                                                            |
| -d                           | It means to disable the function of URL Access Control.                                                                                                                                           |
| -a                           | Set the action of specific application, P or B.<br>B: Block. The web access meets the URL Access Control will be blocked.<br>P: Pass. The web access meets the URL Access Control will be passed. |
| -i                           | Prevent the web access from any IP address.<br>E: Enable the function. The Internet access from any IP address will be blocked.<br>D: Disable the function.                                       |
| -o                           | Set the keyword object.                                                                                                                                                                           |
| <i>KEY_WORD_Object_Index</i> | Specify the index number of the object profile.                                                                                                                                                   |
| -g                           | Set the keyword group.                                                                                                                                                                            |
| <i>KEY_WORD_Group_Index</i>  | Specify the index number of the group profile.                                                                                                                                                    |

### Example

```
> csm ucf obj 1 uac -i E
Log:[block]
Priority Select : [Either : Url Access Control First]
-----
URL Access Control
```

```

[ ]Enable URL Access Control   Action:[pass]
[v]Prevent web access from IP address.
  No  Obj NO.   Object Name
  ---  ---
  No  Grp NO.   Group Name
  ---  ---

> csm ucf obj 1 uac -a B
Log:[block]
Priority Select : [Either : Url Access Control First]
-----
URL Access Control
[ ]Enable URL Access Control   Action:[block]
[v]Prevent web access from IP address.
  No  Obj NO.   Object Name
  ---  ---
  No  Grp NO.   Group Name
  ---  ---

>

```

## Telnet Command: csm ucf obj INDEX wf

It means to configure the settings regarding to Web Feature (wf).

### Syntax

```

csm ucf obj INDEX wf -v
csm ucf obj INDEX wf -e
csm ucf obj INDEX wf -d
csm ucf obj INDEX wf -a P/B
csm ucf obj INDEX wf -s WEB_FEATURE
csm ucf obj INDEX wf -u WEB_FEATURE
csm ucf obj INDEX wf -f File_Extension_Object_index

```

### Syntax Description

| Parameter             | Description                                                                                                                                                                |
|-----------------------|----------------------------------------------------------------------------------------------------------------------------------------------------------------------------|
| <i>INDEX</i>          | It means to specify the index number of CSM profile, from 1 to 8.                                                                                                          |
| <i>-v</i>             | It means to view the protocol configuration of the CSM profile.                                                                                                            |
| <i>-e</i>             | It means to enable the restriction of web feature.                                                                                                                         |
| <i>-d</i>             | It means to disable the restriction of web feature.                                                                                                                        |
| <i>-a P/B</i>         | Set the action of web feature, P or B.<br>B: Block. The web access meets the web feature will be blocked.<br>P: Pass. The web access meets the web feature will be passed. |
| <i>-s WEB_FEATURE</i> | It means to enable the the Web Feature configuration.<br>Features available for configuration are:<br>c: Cookie<br>p: Proxy<br>u: Upload                                   |
| <i>-u WEB_FEATURE</i> | It means to cancel the web feature configuration.                                                                                                                          |

|                                    |                                                                |
|------------------------------------|----------------------------------------------------------------|
| <i>-f</i>                          | It means to set the file extension object index number.        |
| <i>File_Extension_Object_index</i> | Enter the index number (1 to 8) for the file extension object. |

## Example

```
> csm ucf obj 1 wf -s c
-----
Web Feature
[ ] Enable Restrict Web Feature   Action:[pass]

File Extension Object Index : [0] Profile Name : []

[V] Cookie [ ] Proxy [ ] Upload
```

## Telnet Command: csm wcf

It means to configure the settings regarding to web control filter (wcf).

### Syntax

```
csm wcf show
csm wcf look
csm wcf cache
csm wcf server WCF_SERVER
csm wcf msg MSG
csm wcf setdefault
csm wcf obj INDEX -v
csm wcf obj INDEX -a P/B
csm wcf obj INDEX -n PROFILE_NAME
csm wcf obj INDEX -l P/B/A
csm wcf obj INDEX -o KEY_WORD Object Index
csm wcf obj INDEX -g KEY_WORD Group Index
csm wcf obj INDEX -w E/D/P/B
csm wcf obj INDEX -s CATEGORY|WEB_GROUP
csm wcf obj INDEX -u CATEGORY|WEB_GROUP
```

### Syntax Description

| Parameter                | Description                                                                                                            |
|--------------------------|------------------------------------------------------------------------------------------------------------------------|
| <i>show</i>              | It means to display the web content filter profiles.                                                                   |
| <i>look</i>              | It means to display the license information of WCF.                                                                    |
| <i>Cache</i>             | It means to set the cache level for the profile.                                                                       |
| <i>Server WCF_SERVER</i> | It means to set web content filter server.                                                                             |
| <i>Msg MSG</i>           | It means to set the administration message.<br>MSG means the content (less than 255 characters) of the message itself. |
| <i>setdefault</i>        | It means to return to default settings for all of the profile.                                                         |
| <i>obj</i>               | It means to specify the object profile.                                                                                |
| <i>INDEX</i>             | It means to specify the index number of web content filter profile, from 1 to 8.                                       |
| <i>- v</i>               | It means to view the web content filter profile.                                                                       |

|                              |                                                                                                                                                                                                                                                                                                                                                                                                                                                                                                                                                                                                                                                                                                                                                                                                                                                                                                                                                                                                                                                                                                                                                               |
|------------------------------|---------------------------------------------------------------------------------------------------------------------------------------------------------------------------------------------------------------------------------------------------------------------------------------------------------------------------------------------------------------------------------------------------------------------------------------------------------------------------------------------------------------------------------------------------------------------------------------------------------------------------------------------------------------------------------------------------------------------------------------------------------------------------------------------------------------------------------------------------------------------------------------------------------------------------------------------------------------------------------------------------------------------------------------------------------------------------------------------------------------------------------------------------------------|
| <i>-a P/B</i>                | Set the action of web content filter profile, P or B.<br>B: Block. The web access meets the web feature will be blocked.<br>P: Pass. The web access meets the web feature will be passed.                                                                                                                                                                                                                                                                                                                                                                                                                                                                                                                                                                                                                                                                                                                                                                                                                                                                                                                                                                     |
| <i>-n</i>                    | It means to set the profile name.                                                                                                                                                                                                                                                                                                                                                                                                                                                                                                                                                                                                                                                                                                                                                                                                                                                                                                                                                                                                                                                                                                                             |
| <i>PROFILE_NAME</i>          | It means to specify the name of the profile (less than 16 characters)                                                                                                                                                                                                                                                                                                                                                                                                                                                                                                                                                                                                                                                                                                                                                                                                                                                                                                                                                                                                                                                                                         |
| <i>-I P/B/A</i>              | It means the log type of the profile. They are:<br>P: Pass,<br>B: Block,<br>A: All                                                                                                                                                                                                                                                                                                                                                                                                                                                                                                                                                                                                                                                                                                                                                                                                                                                                                                                                                                                                                                                                            |
| <i>-o</i>                    | Set the keyword object.                                                                                                                                                                                                                                                                                                                                                                                                                                                                                                                                                                                                                                                                                                                                                                                                                                                                                                                                                                                                                                                                                                                                       |
| <i>KEY_WORD_Object_Index</i> | Specify the index number of the object profile.                                                                                                                                                                                                                                                                                                                                                                                                                                                                                                                                                                                                                                                                                                                                                                                                                                                                                                                                                                                                                                                                                                               |
| <i>-g</i>                    | Set the keyword group.                                                                                                                                                                                                                                                                                                                                                                                                                                                                                                                                                                                                                                                                                                                                                                                                                                                                                                                                                                                                                                                                                                                                        |
| <i>KEY_WORD_Group_Index</i>  | Specify the index number of the group profile.                                                                                                                                                                                                                                                                                                                                                                                                                                                                                                                                                                                                                                                                                                                                                                                                                                                                                                                                                                                                                                                                                                                |
| <i>-w</i>                    | It means to set the action for the black and white list.<br>E:Enable,<br>D:Disable,<br>P:Pass,<br>B:Block                                                                                                                                                                                                                                                                                                                                                                                                                                                                                                                                                                                                                                                                                                                                                                                                                                                                                                                                                                                                                                                     |
| <i>-s</i>                    | It means to choose the items under CATEGORY or WEB_GROUP.                                                                                                                                                                                                                                                                                                                                                                                                                                                                                                                                                                                                                                                                                                                                                                                                                                                                                                                                                                                                                                                                                                     |
| <i>-u</i>                    | It means to discard items under CATEGORY or WEB_GROUP.                                                                                                                                                                                                                                                                                                                                                                                                                                                                                                                                                                                                                                                                                                                                                                                                                                                                                                                                                                                                                                                                                                        |
| <b>WEB_GROUP</b>             | Child_Protection, Leisure, Business, Chating, Computer Internet, Other                                                                                                                                                                                                                                                                                                                                                                                                                                                                                                                                                                                                                                                                                                                                                                                                                                                                                                                                                                                                                                                                                        |
| <b>CATEGORY</b>              | Includes:<br>"Advertisement & Pop-Ups", "Alcohol & Tobacco", "Anonymizers", "Arts", "Business", "Transportation", "Chat", "Forums & Newsgroups", "Compromised", "Computers & Technology", "Criminal & Activity", "Dating & Personals", "Down sites", "Education", "Entertainment", "Finance", "Gambling", "Games", "Government", "Hate & Intolerance", "Health & Medicine", "Illegal Drug", "Job Search", "Streaming Media & Downloads", "News", "Non-profits & NGOs", "Nudity", "Personal Sites", "Phishing & Fraud", "Politics", "Pornography & Sexually explicit", "Real Estate", "Religion", "Restaurants & Dining", "Search engines & Portals", "Shopping", "Social Networking", "Spam sites", "Sports", "Malware", "Translators", "Travel", "Violence", "Weapons", "Web-Based Email", "General", "Leisure & Recreation", "Botnets", "Cults", "Fashion & Beauty", "Greeting Cards", "Hacking", "Illegal Softwares", "Image Sharing", "Information Security", "Instant Messaging", "Network Errors", "Parked Domains", "Peer-to-Peer", "Private IP Address", "School Cheating", "Sex Education", "Tasteless", "Child Abuse Images", "Uncategorised Sites" |

## Example

```

> csm wcf obj 1 -n test_wcf
Profile Index: 1
Profile Name:[test_wcf]
[ ]White/Black list
Action:[block]
  No  Obj NO.   Object Name
-----
  No  Grp NO.   Group Name
-----
Action:[block]
Log:[block]
-----
Security
  [ ]Anonymizers           [ ]Compromised           [ ]Phi
shing & Fraud

```

```

[ ]Spam Sites nets [ ]Malware [ ]Bot
[ ]Network Errors [ ]Parked Domains
-----
Parent Control
[v]Alcohol & Tobacco [v]Chat [v]Criminal & Activity
[v]Hate & Intolerance [v]Illegal Drug [v]Nudity
[v]Pornography & Sexually Explicit [v]Violence [v]Weapons
[v]Cults [v]School Cheating [v]Sex Education
[v]Tasteless [v]Child Abuse Images
-----
Productivity
[ ]Advertisement & Pop-Ups [ ]Computers & Technology [ ]Dating & Personals [ ]Gaming & Personal
[ ]Download Sites [ ]Finance [ ]Gaming
[ ]Games [ ]Job Search [ ]Streaming Media & Downloads
[ ]Shopping [ ]Social Networking [ ]Sports
[ ]Hacking [ ]Illegal Softwares [ ]Image Sharing
[ ]Instant Messaging [ ]Peer-to-Peer
-----
General Use
[ ]Arts [ ]Business [ ]Transportation [ ]Travel
[ ]Forums & Newsgroups [ ]Education [ ]Entertainment
[ ]Government [ ]Health & Medicine [ ]News
[ ]Non-profits & NGOs [ ]Personal Sites [ ]Politics & Law
[ ]Real Estate [ ]Religion [ ]Restaurants & Dining
[ ]Search Engines & Portals [ ]Translators [ ]Travel
[ ]Web-Based Email [ ]General [ ]Leisure & Recreation
[ ]Fashion & Beauty [ ]Greeting Cards [ ]Information Security
[ ]Private IP Address [ ]Uncategorised Sites
>

```

## Telnet Command: csm dnsf

It means to configure the settings regarding to DNS filter.

### Syntax

```

csm dnsf enable ON/OFF
csm dnsf syslog N/P/B/A
csm dnsf wcf <INDEX>
csm dnsf ucf <INDEX>
csm dnsf cachetime <CACHE_TIME>
csm dnsf blockpage show/on/off
csm dnsf profile_show
csm dnsf profile_edit INDEX
csm dnsf profile_edit INDEX -n <PROFILE_NAME>
csm dnsf profile_edit INDEX -I <P/B/A>

```

```

csm dnsf profile_edit INDEX -w <WCF_PROFILE>
csm dnsf profile_edit INDEX -u <UCF_PROFILE>
csm dnsf profile_edit INDEX -c <CACHE_TIME>
csm dnsf profile_setdefault
csm dnsf local_bw <e/d/p/b/a/g/o/s/c>

```

## Syntax Description

| Parameter                     | Description                                                                                                                                                                                                                                                                                                                                                                          |
|-------------------------------|--------------------------------------------------------------------------------------------------------------------------------------------------------------------------------------------------------------------------------------------------------------------------------------------------------------------------------------------------------------------------------------|
| <i>enable</i>                 | Enable or disable DNS Filter.<br>ON: enable.<br>OFF: disable.                                                                                                                                                                                                                                                                                                                        |
| <i>syslog</i>                 | Determine the content of records transmitting to Syslog.<br>P: Pass. Records for the packets passing through DNS filter will be sent to Syslog.<br>B: Block. Records for the packets blocked by DNS filter will be sent to Syslog.<br>A: All. Records for the packets passing through or blocked by DNS filter will be sent to Syslog.<br>N: None. No record will be sent to Syslog. |
| <i>wcf</i> <INDEX>            | Specify a WCF profile (1 to 8) as the base of DNS filtering. Type a number to indicate the index number of WCF profile (1 is first profile, 2 is second profile, and so on ...).                                                                                                                                                                                                     |
| <i>ucf</i> <INDEX>            | Specify a UCF profile (1 to 8) as the base of DNS filtering. Type a number to indicate the index number of UCF profile (1 is first profile, 2 is second profile, and so on ...).                                                                                                                                                                                                     |
| <i>cachetime</i> <CACHE_TIME> | CACHE_TIME: It means to set the time for cache to live (available values are 1 to 24; 1 is one hour, 2 is two hours, and so on ...) for DNS filter. OFF is no cache ; AUTO is using TTL from pkt.                                                                                                                                                                                    |
| <i>blockpage</i> <value>      | DNS sends block page for redirect port. When a web page is blocked by DNS filter, the router system will send a message page to describe that the page is not allowed to be visited.<br>ON: Enable the function of displaying message page.<br>OFF: Disable the function of displaying message page.<br>SHOW: Display the function of displaying message page is ON or OFF.          |
| <i>profile_show</i>           | Display the table of the DNS filter profile.                                                                                                                                                                                                                                                                                                                                         |
| <i>profile_edit</i>           | Modify the content of the DNS filter profile.                                                                                                                                                                                                                                                                                                                                        |
| <i>-n</i> <PROFILE_NAME>      | PROFILE_NAME: Enter the name of the DNS filter profile that you want to modify.                                                                                                                                                                                                                                                                                                      |
| <i>-l</i> <P/B/A>             | Specify the log type of the profile.<br>P: Pass.<br>B: Block.<br>A: All.                                                                                                                                                                                                                                                                                                             |
| <i>-w</i> <WCF_PROFILE>       | WCF_PROFILE: Enter the index number of the WCF profile.                                                                                                                                                                                                                                                                                                                              |
| <i>-u</i> <UCF_PROFILE>       | UCF_PROFILE: Enter the index number of the UCF profile.                                                                                                                                                                                                                                                                                                                              |
| <i>-c</i> <CACHE_TIME>        | -c means to set the cache time for DNS filter.<br>CACHE_TIME: It means to set the time for cache to live (available values are 1 to 24; 1 is one hour, 2 is two hours, and so on ...) for DNS filter.                                                                                                                                                                                |
| <i>profile_setdefault</i>     | Reset to factory default setting.                                                                                                                                                                                                                                                                                                                                                    |
| <i>local_bw</i> <e/d/p/b/s/c> | Set the Black/White List of DNS Filter Local Setting.<br>e: Enable the function of black/white list.                                                                                                                                                                                                                                                                                 |

|                                                                              |                                                                                                                                                                                                                                                                                                          |
|------------------------------------------------------------------------------|----------------------------------------------------------------------------------------------------------------------------------------------------------------------------------------------------------------------------------------------------------------------------------------------------------|
|                                                                              | <p>d: Disable the function of black/white list.<br/> p: Set the action as "Pass".<br/> b: Set the action as "Block".<br/> s: Show the config setting.<br/> c: Clear the config setting and reset to factory default settings.</p>                                                                        |
| <i>local_bw a &lt;type index&gt;<br/>&lt;START_IP&gt;&lt;END/MASK_IP&gt;</i> | <p>Set the address type for Black/White List of DNS Filter.<br/> type index: Enter 0/1/2/3/4. In which,<br/> 0=mask, 1=single, 2=any, 3=range, 4=group and objects<br/> &lt;START_IP&gt;: Enter an IP address as a starting point.<br/> &lt;END/MASK_IP&gt;: Enter an IP address as an ending point.</p> |
| <i>local_bw g &lt;item number&gt;&lt;group index&gt;</i>                     | <p>Select the group index for Black/White List of DNS Filter.<br/> item_number: 1 or 2 (group 1 or group 2)<br/> group_index: 1 to 192</p>                                                                                                                                                               |
| <i>local_bw o &lt;item number&gt;&lt;group index&gt;</i>                     | <p>Select the object index for Black/White List of DNS Filter.<br/> item_number: 1 or 2 (object 1 or object 2)<br/> object_index: 1 to 32</p>                                                                                                                                                            |

### Example

```

> csm dnsf local_bw e 1
Enable the Block and White List.
> csm dnsf wcf 1
dns service set up!!!
> csm dnsf cachetime auto
use TTL from pkt!!!
> csm dnsf local_bw a 0 192.168.1.20 255.255.255.0
Address Type: 0:mask, 1:single, 2:any, 3:range, 4:object and group
Set the [MASK] Address type
> csm dnsf profile_edit 1 -n testformarket
Profile Index: 1
Profile Name:[testformarket]

Log:[block]

WCF Profile Index: 0

UCF Profile Index: 0

```

### Telnet Command: ddns enable

Enable/disable the DDNS service.

#### Syntax

ddns enable <0/1>

#### Syntax Description

| Parameter                 | Description                                                             |
|---------------------------|-------------------------------------------------------------------------|
| <i>Enable &lt;0/1&gt;</i> | <p>Enable or disable DDNS service.<br/> 1: enable.<br/> 0: disable.</p> |

### Example

```

> ddns enable 1
Enable Dynamic DNS Setup
>

```

### Telnet Command: ddns set

This command allows users to set Dynamica DNS account.

## Syntax

ddns set *option* <value>

## Syntax Description

| Parameter  | Description                                                                                                                                                                                                                                                                                                                                                                                                                     |
|------------|---------------------------------------------------------------------------------------------------------------------------------------------------------------------------------------------------------------------------------------------------------------------------------------------------------------------------------------------------------------------------------------------------------------------------------|
| -i <value> | It means index number of Dynamic DNS Account.<br><value>=1-6                                                                                                                                                                                                                                                                                                                                                                    |
| -E <value> | It means to enable /disable Dynamic DNS Account.<br><value>=0-1<br>0: Disable<br>1: Enable                                                                                                                                                                                                                                                                                                                                      |
| -W <value> | It means to specify WAN Interface.<br><value>=1-6<br>1: WAN1 First<br>2: WAN1 Only<br>3: WAN2 First<br>4: WAN2 Only<br>5: WAN3 First<br>6: WAN3 Only<br>example: To set WAN Interface: WAN1 First                                                                                                                                                                                                                               |
| -L <value> | It means to type Login Name.<br>[value]: limit up to 64 characters                                                                                                                                                                                                                                                                                                                                                              |
| -P <value> | It means to type Password.<br>[value]: limit up to 24 characters                                                                                                                                                                                                                                                                                                                                                                |
| -C <value> | It means to enable /disable Wildcards.<br><value>=0-1<br>0: Disable<br>1: Enable                                                                                                                                                                                                                                                                                                                                                |
| -B <value> | It means to enable / disable Backup MX.<br><value>=0-1<br>0: Disable<br>1: Enable                                                                                                                                                                                                                                                                                                                                               |
| -M <value> | It means to type Mail Extender.<br>[value]: limit up to 60 characters                                                                                                                                                                                                                                                                                                                                                           |
| -R <value> | It means to type Determine Real WAN IP.<br><value>=0-1<br>0: WAN IP,<br>1: Internet IP                                                                                                                                                                                                                                                                                                                                          |
| -S <value> | It means to specify Servive Provider.<br>If user want to set User-Defined page, value must select 1.<br><value>= 1-19<br>1: User-Defined<br>2:3322 DDNS (www.3322.org)<br>3: ChangeIP.com (www.changeip.com)<br>4:ddns.com.cn (www.ddns.com.cn)<br>5: DtDNS (www.dtdns.com)<br>6: dyn.com (www.dyn.com)<br>7: DynAccess (www.dynaccess.com)<br>8: dynami.co.za (www.dynami.co.za)<br>9: freedns.afraid.org (freedns.afraid.org) |



|                                         |                                                                                                                                                                                                                                                                                                                                                                               |
|-----------------------------------------|-------------------------------------------------------------------------------------------------------------------------------------------------------------------------------------------------------------------------------------------------------------------------------------------------------------------------------------------------------------------------------|
|                                         | 10: NO-IP.COM Free (www.no-ip.com)<br>11:.opendns.com (www.opendns.com)<br>12: OVH (www.ovh.com)<br>13: Strato (www.strato.eu)<br>14: TwoDNS (www.twodns.de)<br>15: TZO (www.tzo.com)<br>16: ubddns.org (ubddns.org)<br>17: Viettel DDNS (vddns.vn)<br>18: vigorddns.com (www.vigorddns.com)<br>19: ZoneEdit DDNS (dynamic.zoneedit.com)                                      |
| <i>T</i> <value>                        | It means to type Service Type.<br><value>= 1-3<br>1: Dynamic<br>2: Custom<br>3: Static                                                                                                                                                                                                                                                                                        |
| <i>-D</i> <Host Name> <sub Domain Name> | It means to type Domain Name.<br>i.e: Account index 1 setting Domain Name for Dynamic Service Type<br>>> ddns set -i 1 -T 1 -D "host ddns.com.cn"<br>i.e: Account index 2 setting Domain Name for Custom Service Type<br>>> ddns set -i 2 -T 2 -D "domain name"<br>i.e: Account index 3 setting Domain Name for Static Service Type<br>>> ddns set -i 3 -T 3 -D "domain name" |
| <i>-H</i> <value>                       | It means to type User-Defined Provider Host.<br><value>= limit up to 64 characters                                                                                                                                                                                                                                                                                            |
| <i>-A</i> <value>                       | It means to type User-Defined Service API.<br><value>= limit up to 256 characters                                                                                                                                                                                                                                                                                             |
| <i>-a</i> <value>                       | It means to type User-Defined Auth Type.<br><value>=0-1<br>0: basic<br>1: URL                                                                                                                                                                                                                                                                                                 |
| <i>-N</i> <value>                       | It means to type User-Defined Connection Type.<br><value>=0-1<br>0: Http<br>1: Https                                                                                                                                                                                                                                                                                          |
| <i>-O</i> <value>                       | It means to type User-Defined Server Response.<br><value>: limit up to 32 characters                                                                                                                                                                                                                                                                                          |

### Example

```
> ddns set -i 1 -S 6 -T 1 -D "hostname dnsalias.net" -L user1 -P pwd1
> Save OK
```

### Telnet Command: ddns log

Displays the DDNS log.

### Example

```
> ddns log
>
```

## Telnet Command: ddns time

Sets and displays the DDNS time.

### Syntax

ddns time <update in minutes>

### Syntax Description

| Parameter                | Description                                                 |
|--------------------------|-------------------------------------------------------------|
| <i>Update in minutes</i> | Enter the value as DDNS time. The range is from 1 to 14400. |

### Example

```
> ddns time
ddns time <update in minutes>
Valid: 1 ~ 1440
%Now: 1440
> ddns time 1000
ddns time <update in minutes>
Valid: 1 ~ 1440
%Now: 1000
```

## Telnet Command: ddns forceupdate

This command will update DDNS automatically.

### Example

```
> ddns forceupdate
Now updating DDNS ...
Please check result by using command "ddns log"
```

## Telnet Command: ddns setdefault

This command will return DDS with factory default settings.

### Example

```
> ddns setdefault
> Set to Factory Default.
```

## Telnet Command: ddns show

This command allows users to check the content of selected DDNS account.

### Syntax

ddns show -i <value>

### Syntax Description

| Parameter               | Description                                                                                              |
|-------------------------|----------------------------------------------------------------------------------------------------------|
| <i>-i &lt;value&gt;</i> | Display the content of selected DDNS account by entering the index number of the account.<br><value>=1-6 |

### Example

```

> ddns show -i 1
-----
Index: 1
[ ] Enable Dynamic DNS Account
WAN Interface: WAN1 First
Service Provider: dyn.com (www.dyn.com)
Service Type: Dynamic
Domain Name: [].[]
Login Name:
[ ] Wildcards
[ ] Backup MX
Mail Extender:
Determine Real WAN IP: WAN IP

>

```

## Telnet Command: dos

This command allows users to configure the settings for DoS defense system.

### Syntax

```

dos -V / D / A
dos -s ATTACK_F [THRESHOLD][ TIMEOUT]
dos -a / e [ATTACK_F][ATTACK_0] / d [ATTACK_F][ATTACK_0]
dos -o <LOG_TYPE> /p <LOG_TYPE> /l <LOG_TYPE>
dos -P <add4/remove4> <type> <value> /<add6/remove6> <type> <value> | <show> |
remove4 all |remove6 all>
dos -B <add4/remove4> <type> <value> /<add6/remove6> <type> <value> | <show> |
remove4 all |remove6 all>
dos -o <0/1>
dos -p <0/1>
dos -l <1/2/3>
dos -f <0/1/show>
dos -i <1/2/3/4/show>

```

### Syntax Description

| Parameter | Description                                                                                                       |
|-----------|-------------------------------------------------------------------------------------------------------------------|
| -V        | It means to view the configuration of DoS defense system.                                                         |
| -D        | It means to deactivate the DoS defense system.                                                                    |
| -A        | It means to activate the DoS defense system.                                                                      |
| -s        | It means to enable the defense function for a specific attack and set its parameter(s).                           |
| ATTACK_F  | It means to specify the name of flooding attack(s) or portscan, e.g., synflood, udpflood, icmpflood, or portscan. |
| THRESHOLD | It means the packet rate (packet/second) that a flooding attack will be detected. Set a value larger than 20.     |
| TIMEOUT   | It means the time (seconds) that a flooding attack will be blocked. Set a value larger than 5.                    |

|                                                                                                                                                                      |                                                                                                                                                                                                                                                                                                                                                                                                                                                                                |
|----------------------------------------------------------------------------------------------------------------------------------------------------------------------|--------------------------------------------------------------------------------------------------------------------------------------------------------------------------------------------------------------------------------------------------------------------------------------------------------------------------------------------------------------------------------------------------------------------------------------------------------------------------------|
| <code>-a</code>                                                                                                                                                      | It means to enable the defense function for all attacks listed in ATTACK_0.                                                                                                                                                                                                                                                                                                                                                                                                    |
| <code>-e</code>                                                                                                                                                      | It means to enable defense function for a specific attack(s).                                                                                                                                                                                                                                                                                                                                                                                                                  |
| <code>ATTACK_0</code>                                                                                                                                                | It means to specify a name of the following attacks: ip_option, tcp_flag, land, teardrop, smurf, pingofdeath, traceroute, icmp_frag, syn_frag, unknow_proto, fraggle.                                                                                                                                                                                                                                                                                                          |
| <code>-d</code>                                                                                                                                                      | It means to disable the defense function for a specific attack(s).                                                                                                                                                                                                                                                                                                                                                                                                             |
| <code>-P &lt;add4/remove4&gt; &lt;type&gt; &lt;value&gt;   &lt;add6/remove6&gt; &lt;type&gt; &lt;value&gt;   &lt;show&gt;   &lt;remove4 all   remove6 all&gt;</code> | <p>Add or remove the IPv4/IPv6 address in the white passing IP list.</p> <p>add4/remove4: Add /remove an IPv4/IPv6 address to/from the whitelist.</p> <p>add6/remove6: Add/remove an IPv6 address to/from the whitelist.</p> <p>Type: Two types, -i and -c. In which, "-i" means the IPv4 address and "-c" means the country object.</p> <p>Value: Enter the IP address for -i; enter the index number of the country object profile.</p> <p>Show: Display the whitelist.</p>  |
| <code>-B &lt;add4/remove4&gt; &lt;type&gt; &lt;value&gt;   &lt;add6/remove6&gt; &lt;type&gt; &lt;value&gt;   &lt;show&gt;   &lt;remove4 all   remove6 all&gt;</code> | <p>Add or remove the IPv4/IPv6 address in the black blocking IP list.</p> <p>add4/remove4: Add /remove an IPv4/IPv6 address to/from the blacklist.</p> <p>add6/remove6: Add/remove an IPv6 address to/from the blacklist.</p> <p>Type: Two types, -i and -c. In which, "-i" means the IPv4 address and "-c" means the country object.</p> <p>Value: Enter the IP address for -i; enter the index number of the country object profile.</p> <p>Show: Display the blacklist.</p> |
| <code>dos -o &lt;LOG_TYPE&gt;</code>                                                                                                                                 | <p>Enable/Disable dos defense log.</p> <p>&lt;LOG_TYPE&gt;: Enter 0 or 1.</p> <p>0: Disable</p> <p>1: Enable</p>                                                                                                                                                                                                                                                                                                                                                               |
| <code>dos -p &lt;LOG_TYPE&gt;</code>                                                                                                                                 | <p>Enable/Disable spoofing defense log.</p> <p>&lt;LOG_TYPE&gt;: Enter 0 or 1.</p> <p>0: Disable</p> <p>1: Enable</p>                                                                                                                                                                                                                                                                                                                                                          |
| <code>dos -l &lt;LOG_TYPE&gt;</code>                                                                                                                                 | <p>Enable/Disable dos defense black/white list log.</p> <p>&lt;LOG_TYPE&gt;: Enter 0 to 3.</p> <p>0: None</p> <p>1: White list</p> <p>2: Black List</p> <p>3: All</p>                                                                                                                                                                                                                                                                                                          |
| <code>dos -f &lt;0/1/show&gt;</code>                                                                                                                                 | <p>Set the priority of whitelist/blacklist.</p> <p>[0/1/show]: 0:WhiteList; 1:BlackList</p>                                                                                                                                                                                                                                                                                                                                                                                    |
| <code>dos -i &lt;1/2/3/4/show&gt;</code>                                                                                                                             | <p>Set the time interval to send the whitelist/blacklist log.</p> <p>[1/2/3/4/show]: 1:30; 2:60; 3:180; 4:300 seconds</p>                                                                                                                                                                                                                                                                                                                                                      |

## Example

```

> dos -A
The Dos Defense system is Activated
> dos -s synflood 50 10
Synflood is enabled! Threshold=50 <pke/sec> timeout=10 <pke/sec>
> dos -P add4 -i 192.168.5.89
Add IP in Passing IP List success.
> dos -P show
DoS White Passing IP List:
  Type      IPv4          Type      IPv6
1. IP      192.168.5.89  IP        ::
2. IP      0.0.0.0       IP        ::
3. IP      0.0.0.0       IP        ::
4. IP      0.0.0.0       IP        ::

```

|     |    |         |    |    |
|-----|----|---------|----|----|
| 5.  | IP | 0.0.0.0 | IP | :: |
| 6.  | IP | 0.0.0.0 | IP | :: |
| 7.  | IP | 0.0.0.0 | IP | :: |
| 8.  | IP | 0.0.0.0 | IP | :: |
| 9.  | IP | 0.0.0.0 | IP | :: |
| 10. | IP | 0.0.0.0 | IP | :: |
| 11. | IP | 0.0.0.0 | IP | :: |
| 12. | IP | 0.0.0.0 | IP | :: |
| 13. | IP | 0.0.0.0 | IP | :: |
| 14. | IP | 0.0.0.0 | IP | :: |
| 15. | IP | 0.0.0.0 | IP | :: |
| 16. | IP | 0.0.0.0 | IP | :: |

## Telnet Command: exit

Type this command will leave telnet window.

## Telnet Command: Internet

This command allows you to configure detailed settings for WAN connection.

### Syntax

internet *-W n -M n [-<command> <parameter> | ... ]*

### Syntax Description

| Parameter                                    | Description                                                                                                                                                                                                                                                                                                                               |
|----------------------------------------------|-------------------------------------------------------------------------------------------------------------------------------------------------------------------------------------------------------------------------------------------------------------------------------------------------------------------------------------------|
| <i>-W n</i>                                  | It means to select WAN interface for configuration.<br>n: 1 to x. The default is WAN1.                                                                                                                                                                                                                                                    |
| <i>-M n</i>                                  | M means to set Internet Access Mode (Mandatory) and n means different modes.<br>n=0: Offline<br>n=1: PPPoE<br>n=2: Dynamic IP<br>n=3: Static IP<br>n=4: PPTP with Dynamic IP,<br>n=5: PPTP with Static IP,<br>n=6: L2TP with Dynamic IP<br>n=7: L2TP with Static IP<br>n=A: 3G/4G USB Modem(PPP mode),<br>n=B: 3G/4G USB Modem(DHCP mode) |
| <i>&lt;command&gt;&lt;parameter&gt;[...]</i> | The available commands with parameters are listed below.<br>[...] means that you can Enter several commands in one line.                                                                                                                                                                                                                  |
| <i>-S &lt;isp name&gt;</i>                   | It means to set ISP Name (max. 23 characters).                                                                                                                                                                                                                                                                                            |
| <i>-P &lt;on/off&gt;</i>                     | It means to enable PPPoE Service.                                                                                                                                                                                                                                                                                                         |
| <i>-u &lt;username&gt;</i>                   | It means to set username (max. 49 characters) for Internet accessing.                                                                                                                                                                                                                                                                     |
| <i>-p &lt;password&gt;</i>                   | It means to set password (max. 49 characters) for Internet accessing.                                                                                                                                                                                                                                                                     |
| <i>-a n</i>                                  | It means to set PPP Authentication Type and n means different types (represented by 0-1).<br>n=0: PAP/CHAP (this is default setting)<br>n=1: PAP Only                                                                                                                                                                                     |
| <i>-t n</i>                                  | It means to set connection duration and n means different conditions.<br>n=-1: Always-on                                                                                                                                                                                                                                                  |

|                   |                                                                                                                                                                                                                                                                           |
|-------------------|---------------------------------------------------------------------------------------------------------------------------------------------------------------------------------------------------------------------------------------------------------------------------|
|                   | n=1 - 999: Idle time for offline (default 180 seconds)                                                                                                                                                                                                                    |
| -i <ip address>   | It means that PPPoE server will assign an IP address specified here for CPE (PPPoE client).<br>If you type 0.0.0.0 as the <ip address>, ISP will assign suitable IP address for you. However, if you type an IP address here, the router will use that one as a fixed IP. |
| -w <ip address>   | It means to assign WAN IP address for such connection. Please type an IP address here for WAN port.                                                                                                                                                                       |
| -n <netmask>      | It means to assign netmask for WAN connection. You have to type 255.255.255.xxx (x is changeable) as the netmask for WAN port.                                                                                                                                            |
| -g <gateway>      | It means to assign gateway IP for such WAN connection.                                                                                                                                                                                                                    |
| -s <server ip>    | It means to set PPTP/L2TP server IP.                                                                                                                                                                                                                                      |
| -A <idx>          | Set to Always On mode, and <idx> as backup WAN#                                                                                                                                                                                                                           |
| -B <mode>         | Set to Backup mode.<br><mode> 0: When any WAN disconnect; 1: When all WAN disconnect.                                                                                                                                                                                     |
| -V                | It means to view Internet Access profile.                                                                                                                                                                                                                                 |
| -C <sim pin code> | Set (PPP mode) SIM PIN code (max. 15 characters).                                                                                                                                                                                                                         |
| -O <init string>  | Set (PPP mode) Modem Initial String (max. 47 characters).                                                                                                                                                                                                                 |
| -T <init string2> | Set (PPP mode) Modem Initial String2 (max. 47 characters)                                                                                                                                                                                                                 |
| -D <dial string>  | Set (PPP mode) Modem Dial String (max. 31 characters).                                                                                                                                                                                                                    |
| -v <service name> | Set (PPP mode) Service Name (max. 23 characters).                                                                                                                                                                                                                         |
| -m <ppp username> | Set (PPP mode) PPP Username (max. 63 characters).                                                                                                                                                                                                                         |
| -o <ppp password> | Set (PPP mode) PPP Password (max. 62 characters).                                                                                                                                                                                                                         |
| -e n              | Set (PPP mode) PPP Authentication Type.<br>n= 0: PAP/CHAP (default),<br>1: PAP Only                                                                                                                                                                                       |
| -q n              | (PPP mode) Index(1-15) in Schedule Setup-One                                                                                                                                                                                                                              |
| -x n              | (PPP mode) Index(1-15) in Schedule Setup-Two                                                                                                                                                                                                                              |
| -y n              | (PPP mode) Index(1-15) in Schedule Setup-Three                                                                                                                                                                                                                            |
| -z n              | (PPP mode) Index(1-15) in Schedule Setup-Four                                                                                                                                                                                                                             |
| -Q <mode>         | Set (PPP mode or DHCP mode) WAN Connection Detection Mode.<br><mode><br>0: ARP Detect;<br>1: Ping Detect                                                                                                                                                                  |
| -I <ping ip>      | Set (PPP mode or DHCP mode) WAN Connection Detection Ping IP.<br><ping ip>= ppp.qqq.rrr.sss: WAN Connection Detection Ping IP                                                                                                                                             |
| -L n              | Set (PPP mode) WAN Connection Detection TTL (1-255) value.                                                                                                                                                                                                                |
| -R n              | Set (PPP mode) WAN Connection Detection Echo Interval secondes.<br>n= 3 to 60.                                                                                                                                                                                            |
| -E <sim pin code> | Set (DHCP mode) SIM PIN code (max. 19 characters).                                                                                                                                                                                                                        |
| -G <mode>         | Set (DHCP mode) Network Mode.<br><mode><br>0: 4G/3G/2G;<br>1: 4G Only;<br>2: 3G Only;<br>3: 2G Only                                                                                                                                                                       |
| -N <apn name>     | Set (DHCP mode) APN Name (max. 47 characters)                                                                                                                                                                                                                             |
| -U <n>            | Set the MTU for DHCP mode.<br>n= 1000 to 1440.                                                                                                                                                                                                                            |

## Example

```
>internet -M 1 -S tcom -u username -p password -a 0 -t -1 -i 0.0.0.0
WAN1 Internet Mode set to PPPoE/PPPoA
WAN1 ISP Name set to tcom
WAN1 Username set to username
WAN1 Password set successful
WAN1 PPP Authentication Type set to PAP/CHAP
WAN1 Idle timeout set to always-on
WAN1 Gateway IP set to 0.0.0.0
> internet -V
WAN1 Internet Mode:PPPoE
ISP Name: tcom
Username: username
Authentication: PAP/CHAP
Idle Timeout: -1
WAN IP: Dynamic IP
>
```

## Telnet Command: ip pubsubnet

This command allows users to enable or disable the IP routing subnet for your router.

### Syntax

ip pubsubnet <Enable/Disable>

### Syntax Description

| Parameter      | Description           |
|----------------|-----------------------|
| <i>Enable</i>  | Enable the function.  |
| <i>Disable</i> | Disable the function. |

### Example

```
> ip pubsubnet enable
public subnet enabled!
>
```

## Telnet Command: ip pubaddr

This command allows to set the IP routed subnet for the router.

### Syntax

ip pubaddr ?

ip pubaddr <public subnet IP address>

### Syntax Description

| Parameter                       | Description                                                                                            |
|---------------------------------|--------------------------------------------------------------------------------------------------------|
| <i>?</i>                        | Display an IP address which allows users set as the public subnet IP address.                          |
| <i>public subnet IP address</i> | Specify an IP address. The system will set the one that you specified as the public subnet IP address. |

## Example

```
> ip pubaddr ?
% ip addr <public subnet IP address>
% Now: 192.168.0.1

> ip pubaddr 192.168.2.5
% Set public subnet IP address done !!!
```

## Telnet Command: ip pubmask

This command allows users to set the mask for IP routed subnet of your router.

### Syntax

```
ip pubmask ?
ip pubmask <public subnet mask>
```

### Syntax Description

| Parameter                       | Description                                                                                      |
|---------------------------------|--------------------------------------------------------------------------------------------------|
| ?                               | Display an IP address which allows users set as the public subnet mask.                          |
| <i>public subnet IP address</i> | Specify a subnet mask. The system will set the one that you specified as the public subnet mask. |

## Example

```
> ip pubmask ?
% ip pubmask <public subnet mask>
% Now: 255.255.255.0

> ip pubmask 255.255.0.0
% Set public subnet mask done !!!
```

## Telnet Command: ip lanalias

This command is used for configuring WAN IP Alias.

### Syntax

```
ip lanalias <idx> <option>
```

### Syntax Description

| Parameter       | Description                                                                                |
|-----------------|--------------------------------------------------------------------------------------------|
| <idx>           | It means the index number of the profile.<br>Idx: 1 to 5                                   |
| <option>        | The available commands with parameters are listed below.                                   |
| -e <0/1>        | It means to enable / disable the function of IP alias.<br>0: disable<br>1: enable          |
| -a <IP address> | It means to set auxiliary IP address.                                                      |
| -w n            | It means to add an address for the selected WAN interface.<br>N=0, none<br>N=1, means WAN1 |



|    |                                                               |
|----|---------------------------------------------------------------|
|    | N=2, means WAN2<br>...                                        |
| -r | It means to remove the address of the selected WAN interface. |

## Example

```
> ip lanalias 1 -r
> ip lanalias 1 -a 192.168.1.2
> ip lanalias
Usage:
%% ip lanalias [idx] [Option]
  idx  :profile index from 1 to 5
Option:
-e 1          :1:enable, 0:disable
-a 192.168.1.2 :IP Address as alias
-w 1          :WAN number or 0(None)
-r           :remove this profile

LAN IP Alias Address table:
Index no.      Status  IP address      Prefer Output
-----
1              Disable 192.168.1.2    n/a
2              Disable 0.0.0.0         n/a
3              Disable 0.0.0.0         n/a
4              Disable 0.0.0.0         n/a
5              Disable 0.0.0.0         n/a
```

## Telnet Command: ip addr

This command allows users to set/add a specified LAN IP your router.

### Syntax

ip addr <IP address>

### Syntax Description

| Parameter  | Description                  |
|------------|------------------------------|
| IP address | It means the LAN IP address. |

## Example

```
>ip addr 192.168.50.1
% Set IP address OK !!!
```



### Info

When the LAN IP address is changed, the start IP address of DHCP server are still the same. To make the IP assignment of the DHCP server being consistent with this new IP address (they should be in the same network segment), the IP address of the PC must be fixed with the same LAN IP address (network segment) set by this command for accessing into the web user interface of the router. Later, modify the start addresses for the DHCP

---

server.

---

## Telnet Command: ip nmask

This command allows users to set/add a specified netmask for your router.

### Syntax

ip nmask <IP netmask>

### Syntax Description

| Parameter         | Description                     |
|-------------------|---------------------------------|
| <i>IP netmask</i> | It means the netmask of LAN IP. |

### Example

```
> ip nmask 255.255.0.0
% Set IP netmask OK !!!
```

## Telnet Command: ip arp

ARP displays the matching condition for IP and MAC address.

### Syntax

ip arp add <IP address> <MAC address> <LAN or WAN>

ip arp del <IP address> <LAN or WAN>

ip arp flush

ip arp status

ip arp accept <0/1/2/3/4/5/status>

ip arp setCacheLife <time>

In which, arp add allows users to add a new IP address into the ARP table; arp del allows users to remove an IP address; arp flush allows users to clear arp cache; arp status allows users to review current status for the arp table; arp accept allows to accept or reject the source /destination MAC address; arp setCacheLife allows users to configure the duration in which ARP caches can be stored on the system. If ip arp setCacheLife is set with “60”, it means you have an ARP cache at 0 second. Sixty seconds later without any ARP messages received, the system will think such ARP cache is expired. The system will issue a few ARP request to see if this cache is still valid.

### Syntax Description

| Parameter                 | Description                                                                                                                                                                                                                                                                                                          |
|---------------------------|----------------------------------------------------------------------------------------------------------------------------------------------------------------------------------------------------------------------------------------------------------------------------------------------------------------------|
| <i>IP address</i>         | It means the LAN IP address.                                                                                                                                                                                                                                                                                         |
| <i>MAC address</i>        | It means the MAC address of your router.                                                                                                                                                                                                                                                                             |
| <i>LAN or WAN</i>         | It indicates the direction for the arp function.                                                                                                                                                                                                                                                                     |
| <i>0/1/2/3/4/5/status</i> | 0: disable to accept illegal source mac address<br>1: enable to accept illegal source mac address<br>2: disable to accept illegal dest mac address<br>3: enable to accept illegal dest mac address<br>4: Decline VRRP mac into arp table<br>5: Accept VRRP mac into arp table<br>status: display the setting status. |

Time

Available settings will be 10, 20, 30,...2550 seconds.

## Example

```
> ip arp accept status
Accept illegal source mac arp: disable

Accept illegal dest mac arp: disable

Accept VRRP mac into arp table: disable
> ip arp status
[ARP Table]

  Index IP Address      MAC Address          HOST ID      Interface  VLAN  Port
  ---  -
  1    192.168.1.10      60-A4-4C-E6-5A-4F   A1000381    LAN1      ---   P1
  2    192.168.1.12      00-1D-AA-7C-F5-A4   LAN1      LAN1      ---   P3
  3    192.168.1.13      14-49-BC-43-E5-79   LAN1      LAN1      ---   P2
  4    192.168.1.100    14-49-BC-0A-8A-B8   LAN1      LAN1      ---   P5

>
```

## Telnet Command: ip dhcpc

This command is available for WAN DHCP.

### Syntax

`ip dhcpc option`

`ip dhcpc option -h/l`

`ip dhcpc option -d <idx>`

`ip dhcpc option -e<1 or 0> -w <wan unumber> -c <option number> -v <option value>`

`ip dhcpc option -e <1 or 0> -w <wan unumber> -c <option number> -x "<option value>"`

`ip dhcpc option -e <1 or 0> -w <wan unumber> -c <option number> -a <option value>`

`ip dhcpc option -u <idx unumber>`

`ip dhcpc release <wan number>`

`ip dhcpc renew <wan number>`

`ip dhcpc status`

### Syntax Description

| Parameter           | Description                                                                                                                                                                                                                                                                                                                                                                                                                                           |
|---------------------|-------------------------------------------------------------------------------------------------------------------------------------------------------------------------------------------------------------------------------------------------------------------------------------------------------------------------------------------------------------------------------------------------------------------------------------------------------|
| <code>option</code> | It is an optional setting for DHCP server.<br>-h: display usage<br>-l: list all custom set DHCP options<br>-d: delete custom dhcp client option by index number<br>-e: enable/disable option feature, 1:enable, 0:disable<br>-w: set WAN number (e.g., 1=WAN1)<br>-c: set option number: 0-255<br>-v: set option value by string<br>-x: set option value by raw byte (hex)<br>-u: update by index number<br>-r: remove all custom DHCP Client options |

|                |                                                                  |
|----------------|------------------------------------------------------------------|
| <i>release</i> | It means to release current WAN IP address.                      |
| <i>renew</i>   | It means to renew the WAN IP address and obtain another new one. |
| <i>status</i>  | It displays current status of DHCP client.                       |

## Example

```
>ip dhcpc status
=====
WAN1:

DHCP Client Status: None active DHCP client!

=====
WAN2:

DHCP Client Status: None active DHCP client!

=====
WAN3:

DHCP Client Status: None active DHCP client!

=====
WAN4:

DHCP Client Status: None active DHCP client!

=====
WAN5:

DHCP Client Status: None active DHCP client!

=====
WAN6:

DHCP Client Status: None active DHCP client!
...
```

## Telnet Command: ip ping

This command allows users to ping IP address of WAN1/WAN2/PVC3/PVC4/PVC5 for verifying if the WAN connection is OK or not.

## Syntax

**ip ping** <IP address> <AUTO/WAN1/WAN2/WAN5/WAN6> <Source IP address>

## Syntax Description

| Parameter                           | Description                                                          |
|-------------------------------------|----------------------------------------------------------------------|
| <i>IP address</i>                   | It means the WAN IP address.                                         |
| <i>AUTO/WAN1/WAN2/WAN5/WAN6&gt;</i> | It means the WAN port /PVC that the above IP address passes through. |
| <i>Source IP address</i>            | It means the source IP address.                                      |

## Example

```
> ip ping 172.16.3.229 WAN1

Pinging 172.16.3.229 with 64 bytes of Data:
Receive reply from 172.16.3.229, time=0ms
Receive reply from 172.16.3.229, time=0ms
Receive reply from 172.16.3.229, time=0ms
```

```
Packets: Sent = 5, Received = 5, Lost = 0 <0% loss>
```

## Telnet Command: ip tracert

This command allows users to trace the routes from the router to the host.

### Syntax

```
ip tracert <Host/IP address> <WAN1/WAN2/WAN3/WAN4/WAN5/WAN6> <Udp/Icmp>
```

### Syntax Description

| Parameter                            | Description                                                     |
|--------------------------------------|-----------------------------------------------------------------|
| <i>IP address</i>                    | It means the target IP address.                                 |
| <i>WAN1/WAN2/WAN3/WAN4/WAN5/WAN6</i> | It means the WAN port that the above IP address passes through. |
| <i>Udp/Icmp</i>                      | It means the UDP or ICMP.                                       |

### Example

```
>ip tracert 22.128.2.62 WAN1
Traceroute to 22.128.2.62, 30 hops max
 1  172.16.3.7  10ms
 2  172.16.1.2  10ms
 3  Request Time out.
 4  168.95.90.66 50ms
 5  211.22.38.134 50ms
 6  220.128.2.62 50ms
Trace complete
```

## Telnet Command: ip telnet

This command allows users to access specified device by telnet.

### Syntax

```
ip telnet <IP address><Port>
```

### Syntax Description

| Parameter         | Description                                                     |
|-------------------|-----------------------------------------------------------------|
| <i>IP address</i> | Enter the WAN or LAN IP address of the remote device.           |
| <i>Port</i>       | Type a port number (e.g., 23).<br>Available settings: 0 -65535. |

### Example

```
> ip telnet 172.17.3.252 23
>
```

## Telnet Command: ip rip

This command allows users to set the RIP (routing information protocol) of IP.

### Syntax

ip rip <0/1/2>

### Syntax Description

| Parameter | Description                                                      |
|-----------|------------------------------------------------------------------|
| 0/1/2     | 0 means disable; 1 means first subnet and 2 means second subnet. |

### Example

```
> ip rip 1
%% Set RIP 1st subnet.
```

## Telnet Command: ip wanrip

This command allows users to set the RIP (routing information protocol) of WAN IP.

### Syntax

ip wanrip <ifno> -e <0/1>

### Syntax Description

| Parameter | Description                                                                                                                                            |
|-----------|--------------------------------------------------------------------------------------------------------------------------------------------------------|
| ifno      | It means the connection interface.<br>1: WAN1,2: WAN2, 3: PVC3,4: PVC4,5: PVC5<br>Note: PVC3 -PVC5 are virtual WANs.                                   |
| -e        | It means to disable or enable RIP setting for specified WAN interface.<br>1: Enable the function of setting RIP of WAN IP.<br>0: Disable the function. |

### Example

```
> ip wanrip ?
Valid ex:ip wanrip <ifno> -e <0/1>
<ifno> 1: WAN1,2: WAN2
        3: PVC3,4: PVC4,5: PVC5
-e <0/1> 0: disable, 1: enable
Now status:
WAN[1] Rip Protocol disable
WAN[2] Rip Protocol disable
WAN[3] Rip Protocol disable
WAN[4] Rip Protocol disable
WAN[5] Rip Protocol disable
WAN[6] Rip Protocol enable
WAN[7] Rip Protocol enable
WAN[8] Rip Protocol enable
WAN[9] Rip Protocol enable
WAN[10] Rip Protocol enable
WAN[11] Rip Protocol enable
WAN[12] Rip Protocol enable
WAN[13] Rip Protocol enable
WAN[14] Rip Protocol enable
WAN[15] Rip Protocol enable
WAN[16] Rip Protocol enable
> ip wanrip 5 -e 1
> ip wanrip ?
Valid ex:ip wanrip <ifno> -e <0/1>
<ifno> 1: WAN1,2: WAN2
        3: PVC3,4: PVC4,5: PVC5
```

```
-e <0/1> 0: disable, 1: enable
Now status:
WAN[1] Rip Protocol disable
WAN[2] Rip Protocol disable
WAN[3] Rip Protocol disable
WAN[4] Rip Protocol disable
WAN[5] Rip Protocol enable
...
```

## Telnet Command: ip route

This command allows users to set static route.

### Syntax

```
ip route add <dst><netmask><gateway><ifno><rtype>
ip route del <dst><netmask><rtype>
ip route status
ip route cnc
ip route default <wan1/wan2/off/?>
ip route clean <1/0>
```

### Syntax Description

| Parameter      | Description                                                                                                          |
|----------------|----------------------------------------------------------------------------------------------------------------------|
| <i>add</i>     | It means to add an IP address as static route.                                                                       |
| <i>del</i>     | It means to delete specified IP address.                                                                             |
| <i>status</i>  | It means current status of static route.                                                                             |
| <i>dst</i>     | It means the IP address of the destination.                                                                          |
| <i>netmask</i> | It means the netmask of the specified IP address.                                                                    |
| <i>gateway</i> | It means the gateway of the connected router.                                                                        |
| <i>ifno</i>    | It means the connection interface.<br>3=WAN1 5=WAN3,6=WAN4,7=WAN5<br>However, WAN3, WAN4, WAN5 are router-borne WANs |
| <i>rtype</i>   | It means the type of the route.<br>default : default route;<br>static: static route.                                 |
| <i>cnc</i>     | It means current IP range for CNC Network.                                                                           |
| <i>default</i> | Set WAN1/WAN2/off as current default route.                                                                          |
| <i>clean</i>   | Clean all of the route settings.<br>1: Enable the function.<br>0: Disable the function.                              |

### Example

```
> ip route add 172.16.2.0 255.255.255.0 172.16.2.4 3 static
> ip route status

Codes: C - connected, S - static, R - RIP, * - default, ~ - private
C~      192.168.1.0/    255.255.255.0 is directly connected, LAN1
S       172.16.2.0/    255.255.255.0 via 172.16.2.4, WAN1
```

## Telnet Command: ip igmp\_proxy

This command allows users to enable/disable igmp proxy server.

### Syntax

```
ip igmp_proxy set
ip igmp_proxy reset
ip igmp_proxy wan
ip igmp_proxy query
ip igmp_proxy ppp <0/1>
ip igmp_proxy status
ip igmp_proxy version <v2/v3/auto/show>
ip igmp_proxy syslog <0/1>
```

### Syntax Description

| Parameter                              | Description                                                                     |
|----------------------------------------|---------------------------------------------------------------------------------|
| <i>set</i>                             | It means to enable proxy server.                                                |
| <i>reset</i>                           | It means to disable proxy server.                                               |
| <i>wan</i>                             | It means to specify WAN interface for IGMP service.                             |
| <i>query</i>                           | It means to set IGMP general query interval.<br>The default value is 125000 ms. |
| <i>ppp &lt;0/1&gt;</i>                 | 0 - No need to set IGMP with PPP header.<br>1 - Set IGMP with PPP header.       |
| <i>status</i>                          | It means to display current status for proxy server.                            |
| <i>version &lt;v2/v3/auto/show&gt;</i> | It means to set IGMP version fixed on v2 or v3.                                 |
| <i>syslog &lt;0/1&gt;</i>              | It means to set IGMP syslog.<br>0: disable<br>1: enable                         |

### Example

```
> ip igmp_proxy query 130000
This command is for setting IGMP General Query Interval
The default value is 125000 ms
Current Setting is:130000 ms
>
```

## Telnet Command: ip igmp\_snoop

This command allows users to enable or disable IGMP snoop function.

### Syntax

```
ip igmp_snoop enable
ip igmp_snoop disable
ip igmp_snoop status
ip igmp_snoop hw_acc <on/off/status>
ip igmp_snoop txquery <on/off> <v2/v3>
ip igmp_snoop chkleave <on/off>
ip igmp_snoop separate <on/off>
ip igmp_snoop acceptlist <type><index>
```



## Syntax Description

| Parameter                       | Description                                                                                                                                                |
|---------------------------------|------------------------------------------------------------------------------------------------------------------------------------------------------------|
| <i>enable</i>                   | It means to enable igmp snoop function                                                                                                                     |
| <i>disable</i>                  | It means to disable igmp snoop function.                                                                                                                   |
| <i>status</i>                   | It means to display current igmp configuration.                                                                                                            |
| <i>hw_acc</i> <on/off/status>   | It means to enable/disable the multicast hardware acceleration.<br>On: enable the function.<br>Off: disable the function.                                  |
| <i>txquery</i> <on/off> <v2/v3> | It means to send out IGMP QUERY to LAN periodically.<br>On: enable<br>Off: disable<br>v2: version v2<br>v3: version v3                                     |
| <i>chkleave</i> <on/off>        | It means to check the leave status.<br>On: enable the IGMP snoop leave checking function.<br>Off: it will drop LEAVE if still clients on the same group.   |
| <i>separate</i> <on/off>        | It means to set IGMP packets being separated by NAT/Bridge.<br>On: The packets will be separated.<br>Off: The packets will not be separated by NAT/Bridge. |
| <i>acceptlist</i> <type><index> | Type: Enter 0 (disable), 1 (ip object) or 2 (ip group).<br>Index: Enter 0 to 192 (for ip object); enter 0 to 32 (for ip group).                            |

## Example

```
> ip igmp_snoop enable
%% ip igmp snooping [enable|disable|status], IGMP Snooping is Enabled.
> ip igmp_snoop disable
%% ip igmp snooping [enable|disable|status], IGMP Snooping is Disabled.
```

## Telnet Command: ip igmp\_fl

This command allows users to enable or disable IGMP Fast Leave function.

## Syntax

```
ip igmp_fl enable
ip igmp_fl disable
ip igmp_fl status
```

## Syntax Description

| Parameter      | Description                                                |
|----------------|------------------------------------------------------------|
| <i>enable</i>  | It means to enable IGMP Fast Leave function                |
| <i>disable</i> | It means to disable IGMP Fast Leave function.              |
| <i>status</i>  | It means to display current IGMP Fast Leave configuration. |

## Example

```
> ip igmp_fl enable ?
  If you want to use IGMP fast leave , you "MUST" enable IGMP snooping.
```

```

> ip igmp_snoop enable
% ip igmp snooping [enable|disable|status], IGMP Snooping is Enabled.
>

```

## Telnet Command: ip session

This command allows users to set maximum session limit number for the specified IP; set message for exceeding session limit and set how many seconds the IP session block works.

### Syntax

```

ip session on
ip session off
ip session default <num>
ip session defaultp2p <num>
ip session status
ip session show
ip session timer <num>
ip session <block/unblock> <IP>
ip session <add/del> <IP1-IP2> <num> <p2pnum>

```

### Syntax Description

| Parameter                             | Description                                                                                                                                                                                                                                                          |
|---------------------------------------|----------------------------------------------------------------------------------------------------------------------------------------------------------------------------------------------------------------------------------------------------------------------|
| <i>on</i>                             | It means to turn on session limit for each IP.                                                                                                                                                                                                                       |
| <i>off</i>                            | It means to turn off session limit for each IP.                                                                                                                                                                                                                      |
| <i>default</i> <num>                  | It means to set the default number of session num limit.                                                                                                                                                                                                             |
| <i>Defaultp2p</i> <num>               | It means to set the default number of session num limit for p2p.                                                                                                                                                                                                     |
| <i>status</i>                         | It means to display the current settings.                                                                                                                                                                                                                            |
| <i>show</i>                           | It means to display all session limit settings in the IP range.                                                                                                                                                                                                      |
| <i>timer</i> <num>                    | It means to set when the IP session block works.<br>The unit is second.                                                                                                                                                                                              |
| <block/unblock> <IP>                  | It means to block/unblock the specified IP address.<br>Block: The IP cannot access Internet through the router.<br>Unblock: The specified IP can access Internet through the router.                                                                                 |
| <add/del> <IP1-IP2> <num><br><p2pnum> | It means to add / delete the session limits in an IP range.<br><IP1-IP2> - Set the range of IP address specified for this command.<br><num> - Set the number of the session limits, e.g., 100.<br><p2pnum> - Set the number of the session limits, e.g., 50 for P2P. |

### Example

```

> ip session default 100
> ip session add 192.168.1.5-192.168.1.100 100 50
> ip session on
> ip session status

IP range:
  192.168.1.5 - 192.168.1.100 : 100

Current ip session limit is turn on

```

```
Current default session number is 100
```

## Telnet Command: ip bandwidth

This command allows users to set maximum bandwidth limit number for the specified IP.

### Syntax

```
ip bandwidth on  
ip bandwidth off  
ip bandwidth default <tx_rate><rx_rate>  
ip bandwidth status  
ip bandwidth routing <on/off>  
ip bandwidth schedule <s1> <s2> <s3> <s4>  
ip bandwidth show  
ip bandwidth <add/del><IP1-IP2><tx><rx><shared>
```

### Syntax Description

| Parameter                           | Description                                                                                                                     |
|-------------------------------------|---------------------------------------------------------------------------------------------------------------------------------|
| <i>on</i>                           | It means to turn on the IP bandwidth limit.                                                                                     |
| <i>off</i>                          | It means to turn off the IP bandwidth limit.                                                                                    |
| <i>default</i> [tx_rate][rx_rate]   | It means to set default tx and rx rate of bandwidth limit. The range is from 0 - 65535 Kpbs.                                    |
| <i>status</i>                       | It means to display the current settings.                                                                                       |
| <i>routing</i> <on/off>             | It means to apply to IP Routed Subnet.<br>On: apply to<br>Off: not apply to                                                     |
| <i>schedule</i> <s1> <s2> <s3> <s4> | It means to set schedule profile (1 to 4).<br>S1 - S4: Up to four profile can be set. Available schedule profiles from 0 to 16. |
| <i>show</i>                         | It means to display all the bandwidth limits settings within the IP range.                                                      |
| <i>add</i>                          | It means to add the bandwidth within the IP range.                                                                              |
| <i>del</i>                          | It means to delete the bandwidth within the IP range.                                                                           |
| <i>IP1-IP2</i>                      | It means the range of IP address specified for this command.                                                                    |
| <i>tx</i>                           | It means to set transmission rate for bandwidth limit.                                                                          |
| <i>rx</i>                           | It means to set receiving rate for bandwidth limit.                                                                             |
| <i>shared</i>                       | It means that the bandwidth will be shared for the IP range.                                                                    |

### Example

```
> ip bandwidth default 200 800  
> ip bandwidth add 192.168.1.50-192.168.1.100 10 60  
> ip bandwidth status  
  
IP range:  
  192.168.1.50 - 192.168.1.100 : Tx:10K Rx:60K  
  
Current ip Bandwidth limit is turn off
```

```
Auto adjustment is off
```

## Telnet Command: ip dataflowmonitor.

This command allows users to set data flow monitor.

### Syntax

```
ip dataflowmonitor on  
ip dataflowmonitor off  
ip dataflowmonitor status
```

### Syntax Description

| Parameter   | Description                                                       |
|-------------|-------------------------------------------------------------------|
| <i>on</i>   | It means to enable the Data Flow Monitor function.                |
| <i>off</i>  | It means to disable the Data Flow Monitor function.               |
| <i>show</i> | It means to display current status of Data Flow Monitor function. |

### Example

```
> ip dataflowmonitor status  
Data Flow Monitor: Off
```

## Telnet Command: ip bindmac

This command allows users to set IP-MAC binding for LAN host.

### Syntax

```
ip bindmac on  
ip bindmac off  
ip bindmac strict_on  
ip bindmac strict_off  
ip bindmac subnet <all/set LAN_Index/unset LAN_Index/clear/show>  
ip bindmac add <IP><MAC><omment>  
ip bindmac del <IP/all>  
ip bindmac show
```

### Syntax Description

| Parameter                                                             | Description                                                                                                      |
|-----------------------------------------------------------------------|------------------------------------------------------------------------------------------------------------------|
| <i>on</i>                                                             | It means to turn on IP bandmac policy. Even the IP is not in the policy table, it can still access into network. |
| <i>off</i>                                                            | It means to turn off all the bindmac policy.                                                                     |
| <i>strict_on</i>                                                      | It means that only those IP address in IP bindmac policy table can access into network.                          |
| <i>strict_off</i>                                                     | It means to turn off the IP bindmac policy.                                                                      |
| <i>subnet</i> < <i>all/set LAN_Index/unset LAN_Index/clear/show</i> > | It means to set LAN subnet to bind strict mode.                                                                  |
| <i>show</i>                                                           | It means to display the IP address and MAC address of the pair of binded one.                                    |

|                |                                                                              |
|----------------|------------------------------------------------------------------------------|
| <i>add</i>     | It means to add one ip bindmac.                                              |
| <i>del</i>     | It means to delete one ip bindmac.                                           |
| <i>IP</i>      | It means to Enter the IP address for binding with specified MAC address.     |
| <i>MAC</i>     | It means to Enter the MAC address for binding with the IP address specified. |
| <i>Comment</i> | It means to type words as a brief description.                               |
| <i>All</i>     | It means to delete all the IP bindmac settings.                              |

## Example

```
> ip bindmac add 192.168.1.46 00:50:7f:22:33:55 just for test
> ip bindmac show
ip bind mac function is turned OFF
ip bind mac function is STRICT OFF
Show all IP Bind MAC entries.
IP : 192.168.1.46 bind MAC : 00-50-7f-22-33-55 HOST ID :
Comment : just
```

## Telnet Command: ip bgp

Border Gateway Protocol (BGP) is a standardized protocol designed to exchange routing and reachability information among autonomous systems (AS) on the Internet.

### Syntax

```
ip bgp mode <0/1>
ip bgp as <0-4294967295>
ip bgp hold <10-65535>
ip bgp retry <3-255 >
ip bgp id <x.x.x.x>
ip bgp show
ip bgp neighbor <idx> mode <0/1>
ip bgp neighbor <idx> name <max len>
ip bgp neighbor <idx> ip <x.x.x.x>
ip bgp neighbor <idx> as <1-4294967295>
ip bgp neighbor <idx> weight <0-7>
ip bgp neighbor <idx> prepend <0-7>
ip bgp neighbor <idx> md5 <0/1>
ip bgp neighbor <idx> key <max len>
ip bgp neighbor <idx> show
ip bgp neighbor show all
ip bgp static <sidx> <ip> <netmask>
ip bgp static <sidx> delete
ip bgp static show
```

### Syntax Description

| Parameter         | Description                                           |
|-------------------|-------------------------------------------------------|
| <i>mode</i> <0/1> | Enable or disable the GMP.<br>0: disable<br>1: enable |

|                                                |                                                                                                                                                                                                      |
|------------------------------------------------|------------------------------------------------------------------------------------------------------------------------------------------------------------------------------------------------------|
| <i>as</i> <0-4294967295>                       | Set the AS number for local router.<br><0-4294967295>                                                                                                                                                |
| <i>hold</i> <10-65535>                         | Set the time interval (in seconds) to determine the peer is dead when the router is unable to receive any keepalive message from the peer within the time.<br><10-65535>: Default is 180 sec.        |
| <i>retry</i> <3-255>                           | Set the BGP conntion retry time.<br><3-255>: Default is 120 sec                                                                                                                                      |
| <i>id</i> <x.x.x.x>                            | Select a enabled local subnet IP as router ID.<br><x.x.x.x>: Enter an IP address.                                                                                                                    |
| <i>show</i>                                    | Display all BGP settings.                                                                                                                                                                            |
| <i>neighbor</i> <idx> <i>mode</i> <0/1>        | Enable or disable the neighbor profile.<br><idx>: 1 to 8. Index number of the neighbor profile.<br>0: disable<br>1: enable                                                                           |
| <i>neighbor</i> <idx> <i>name</i> <max len>    | Set a name of the neighbor profile.<br><idx>: 1 to 8. Index number of the neighbor profile.<br><max len>: Enter a name (no more than 20 characters).                                                 |
| <i>neighbor</i> <idx> <i>ip</i> <x.x.x.x>      | Set the IP address for the specified neighbor profile.<br><idx>: 1 to 8. Index number of the neighbor profile.<br><x.x.x.x>: Enter an IP address (e.g., 192.168.1.33).                               |
| <i>neighbor</i> <idx> <i>as</i> <1-4294967295> | Set an AS number for the specified neighbor profile.<br><idx>: 1 to 8. Index number of the profile.<br><1-4294967295>: Enter a number.                                                               |
| <i>neighbor</i> <idx> <i>weight</i> <0-7>      | Set the weight value for the specified neighbor profile.<br><idx>: 1 to 8. Index number of the neighbor profile.<br><0-7>: higher is better.                                                         |
| <i>neighbor</i> <idx> <i>prepend</i> <0-7 >    | Set the prepend value for the specified neighbor profile.<br><idx>: 1 to 8. Index number of the neighbor profile.<br><0-7>: lower is better.                                                         |
| <i>neighbor</i> <idx> <i>md5</i> <0/1>         | Enable or disable the MD5 authentication for the neighbor profile.<br><idx>: 1 to 8. Index number of the profile.<br>0: Disable.<br>1: Enable.                                                       |
| <i>neighbor</i> <idx> <i>key</i> <max len>     | Set the key used for the MD5 authentication.<br><idx>: 1 to 8. Index number of the neighbor profile.<br><max len>: Enter a name (no more than 20 characters).                                        |
| <i>neighbor</i> <idx> <i>show</i>              | Display the BGP setting for the specified neighbor profile.<br><idx>: 1 to 8. Index number of the profile.                                                                                           |
| <i>neighbor show all</i>                       | Display the BGP setting of neighbor profiles.                                                                                                                                                        |
| <i>static</i> <sid> <ip> <netmask>             | Set the IP address and subnet mask for specified static network profile.<br><sid>: 1 to 16. Index number of the static network profile.<br><ip>: Enter an IP address.<br><netmask>: Enter a netmask. |
| <i>static</i> <sid> <i>delete</i>              | Remove / clear the settings for the selected static network profile.<br><sid>: 1 to 16. Index number of the profile.                                                                                 |
| <i>static show</i>                             | Display the BGP setting of static network profiles.                                                                                                                                                  |

## Example

```
> ip bgp id 255.255.255.0
```

```

Set BGP router id: 255.255.255.0
> ip bgp show
BGP is enable
Local autonomous system number: 33333
Hold time: 180
Connect retry time: 20
Router ID: 255.255.255.0

BGP neighbor:
Idx Mode As Number Name IP Addr Status weight prepend
-----
1 En 0 Empty None 0 0
2 Dis 0 Empty None 0 0
3 Dis 0 Empty None 0 0
4 Dis 0 Empty None 0 0
5 Dis 0 Empty None 0 0
6 Dis 0 Empty None 0 0
7 Dis 0 Empty None 0 0
8 Dis 0 Empty None 0 0

BGP static networks:
Index: 8, IP addr: 192.168.2.56, mask: 255.255.255.254

```

## Telnet Command: ip maxnatuser

This command is used to set the maximum number of NAT users.

### Syntax

`ip maxnatuser user no`

### Syntax Description

| Parameter      | Description                                                                                                  |
|----------------|--------------------------------------------------------------------------------------------------------------|
| <i>User no</i> | A number specified here means the total NAT users that Vigor router supports.<br>0 - It means no limitation. |

### Example

```

> ip maxnatuser 100
% Max NAT user = 100

```

## Telnet Command: ip policy\_rt

This command is used to set the IP policy route profile.

### Syntax

`ip policy_rt [-<command> <parameter> | ... ]`

### Syntax Description

| Parameter                                    | Description                                                                                                                       |
|----------------------------------------------|-----------------------------------------------------------------------------------------------------------------------------------|
| <i>&lt;command&gt;&lt;parameter&gt;[...]</i> | The available commands with parameters are listed below.<br>[...] means that you can Enter several commands in one line.          |
| <b>General Setup for Policy Route</b>        |                                                                                                                                   |
| <i>-i &lt;value&gt;</i>                      | Specify an index number for setting policy route profile.<br>Value: 1 to 60. "-1" means to get a free policy index automatically. |
| <i>-e &lt;0/1&gt;</i>                        | 0: Disable the selected policy route profile.<br>1: Enable the selected policy route profile.                                     |

|                                       |                                                                                                                                                                                                                                                                      |
|---------------------------------------|----------------------------------------------------------------------------------------------------------------------------------------------------------------------------------------------------------------------------------------------------------------------|
| -o <value>                            | Determine the operation of the policy route.<br>Value:<br>add - Create a new policy route profile.<br>del - Remove an existed policy route profile.<br>edit - Modify an existed policy route profile.<br>flush - Reset policy route to default setting.              |
| -1 <any/range>                        | Specify the source IP mode.<br>Range: Indicate a range of IP addresses.<br>Any: It means any IP address will be treated as source IP address.                                                                                                                        |
| -2<br><any/ip_range/ip_subnet/domain> | Specify the destination IP mode.<br>Any: No need to specify an IP address for any IP address will be treated as destination IP address.<br>ip_range: Indicates a range of IP addresses.<br>ip_subnet: Indicates the IP subnet.<br>domain: Indicates the domain name. |
| -3 <any/range>                        | Specify the destination port mode.<br>Range: Indicate a range of port number.<br>Any: It means any port number can be used as destination port.                                                                                                                      |
| -G <default/specific>                 | Specify the gateway mode.                                                                                                                                                                                                                                            |
| -L <default/specific>                 | Specify the failover gateway mode.                                                                                                                                                                                                                                   |
| -s <value>                            | Indicate the source IP start.<br>Value: The type format shall be "xxx.xxx.xxx.xxx". (e.g, 192.168.1.0)                                                                                                                                                               |
| -S <value>                            | Indicate the source IP end.<br>Value: The type format shall be "xxx.xxx.xxx.xxx". (e.g, 192.168.1.100)                                                                                                                                                               |
| -d <value>                            | Indicate the destination IP start.<br>Value: The type format shall be "xxx.xxx.xxx.xxx". (e.g, 192.168.2.0)                                                                                                                                                          |
| -D <value>                            | Indicate the destination IP end.<br>Value: The type format shall be "xxx.xxx.xxx.xxx". (e.g, 192.168.2.100)                                                                                                                                                          |
| -p<value>                             | Indicate the destination port start.<br>Value: Type a number (1 - 65535) as the port start (e.g., 1000).                                                                                                                                                             |
| -P <value>                            | Indicate the destination port end.<br>Value: Type a number (1 - 65535) as the port end (e.g., 2000).                                                                                                                                                                 |
| -y <value>                            | Indicate the priority of the policy route profile.<br>Value: Type a number (0 - 250). The default value is "150".                                                                                                                                                    |
| -I <value>                            | Indicate the interface specified for the policy route profile.<br>Value: Available interfaces include,<br>LAN1-LAN16, IP_Routed_Subnet, DMZ_Subnet, VOIP_WAN,<br>WAN1-WAN6, VPN_PROFILE_1-VPN_PROFILE_64,WAN_1_IP_ALIAS_1-<br>WAN_4_IP_ALIAS_32                      |
| -g <value>                            | Indicate the gateway IP address.<br>Value: The type format shall be "xxx.xxx.xxx.xxx". (e.g, 192.168.3.1)                                                                                                                                                            |
| -I <value>                            | Indicate the failover IP address.<br>Value: The type format shall be "xxx.xxx.xxx.xxx". (e.g, 192.168.4.1)                                                                                                                                                           |
| -t <value>                            | It means "protocol".<br>Value: Available settings include "TCP", "UDP", "TCP/UDP", "ICMP" and "Any".                                                                                                                                                                 |
| -n <0/1>                              | Indicates the function of "Force NAT".<br>0: Disable the function.<br>1: Enable the function.                                                                                                                                                                        |



|                                  |                                                                                                                                                                                                                                                                         |
|----------------------------------|-------------------------------------------------------------------------------------------------------------------------------------------------------------------------------------------------------------------------------------------------------------------------|
| -F <value>                       | It means "enable failover by MOS".<br>value: 0 or 1                                                                                                                                                                                                                     |
| -M <value>                       | It means "Value of failover MOS".<br>value: 2.0 ~ 4.0                                                                                                                                                                                                                   |
| -a <0/1>                         | Indicates to enable the function of failover.<br>0: Disable the function.<br>1: Enable the function.                                                                                                                                                                    |
| -f <value>                       | It means to specify the interface for failover.<br>Value: Available interfaces include,<br>NO_FAILOVER, Default_WAN,<br>Policy1-Policy50, LAN1-LAN16, IP_Routed_Subnet, DMZ_Subnet,<br>WAN1-WAN6, VPN_PROFILE_1-VPN_PROFILE_64, WAN_1_IP_ALIAS_1 ~<br>WAN_4_IP_ALIAS_32 |
| -b <value>                       | It means "failback".<br>Value: Available settings include,<br>0: Disable the function of "failback".<br>1: Enable the function of "failback".                                                                                                                           |
| -v                               | View current failback setting.                                                                                                                                                                                                                                          |
| <b>Diagnose for Policy Route</b> |                                                                                                                                                                                                                                                                         |
| -s <value>                       | It means "source IP".<br>Value: Available settings include:<br>Any: It indicates any IP address can be used as source IP address.<br>"xxx.xxx.xxx.xxx": The type format (e.g, 192.168.1.0).                                                                             |
| -d <value>                       | It means "destination IP".<br>Value : Available settings include:<br>Any: It indicates any IP address can be used as destination IP address.<br>"xxx.xxx.xxx.xxx": Specify an IP address.                                                                               |
| -p <value>                       | It means "destination port".<br>Value: Specify a number or type Any (indicating any number).                                                                                                                                                                            |
| -t <value>                       | It means "protocol".<br>Value: Available settings include "ICMP", "TCP", "UDP" and "Any".                                                                                                                                                                               |

## Example

```
> ip policy_rt diagnose -s 192.168.1.100 -d any -p any -t ICMP

-----
      Matched Route (Priority)
-----
* No_Match

-----
      Matched Policy (Priority)
-----
* Policy_1 (200)

* Conclusion: The packet was dropped because the send-to interface of the
mat
ched policy "policy 1" was inactive and there was no failover setting
> ip policy_rt -i -1 -o add -1 range -s 192.168.1.10 -S 192.168.1.20 -2
ip_range -d 202.211.100.10 -D 202.211.100.20 -g 202.211.100.1 -I WAN2
```

## Telnet Command: ip lanDNSRes

This command is used to set LAN DNS profiles. With such feature, the user can configure some services (such as ftp, www or database) with domain name which is easy to be accessed.

### Syntax

ip lanDNSRes [-<command> <parameter> | ... ]

### Syntax Description

| Parameter                         | Description                                                                                                                                                                                         |
|-----------------------------------|-----------------------------------------------------------------------------------------------------------------------------------------------------------------------------------------------------|
| -a <IP Address>                   | It is used to configure IP address mapping (IPv4/IPv6 Address or multiple subnet addresses).<br>IP Address: type the IP address (e.g., 192.168.1.56).                                               |
| -c <CNAME>                        | It is used to set CNAME.<br>CNAME: Enter a string.                                                                                                                                                  |
| -d <address mapping index number> | It means to delete index number with address mapping configured.<br>address mapping index number : type the index number which represents the address mapping profile.                              |
| -e <0/1>                          | It means to enable or disable the function of LAN DNS or DNS Forwarding Profile.<br>0: disable<br>1: enable                                                                                         |
| -i <profile setting index number> | It means to create LAN DNS profile with specified domain name.<br>profile setting index number : type the index number which represents the profile with domain name configured.                    |
| -l                                | It means to list detailed information of profile configuration.                                                                                                                                     |
| -n <domain name>                  | It means to specify a domain name to be accessed.                                                                                                                                                   |
| -p <profile name>                 | It means to set name of the LAN DNS profile.                                                                                                                                                        |
| -r                                | It means to clear specified domain name profile and the address mapping setting.                                                                                                                    |
| -R                                | It means to set to factory default setting.                                                                                                                                                         |
| -s <0/1>                          | It means to determine all subnet packets or only the packets with the same subnet will be replied for address mapping profile.<br>0: reply all subnet packets.<br>1: reply only same subnet packet. |
| -z                                | It means to update LAN DNS configuration to DNS cache.                                                                                                                                              |

### Example

```
> ip lanDNSRes -i 1 -n ftp.drayTek.com
% Configure Set1's DomainName:ftp.drayTek.com
> ip lanDNSRes -i 1 -a 172.16.2.10 -s 1
% Configure Set1's IP:172.16.2.10
% Configure Set1's Idx:1 ReplyOnlySameSubnet:Yes
> ip lanDNSRes -i 1 -a 172.16.3.10 -s 1
% Configure Set1's IP:172.16.3.10
% Configure Set1's Idx:2 ReplyOnlySameSubnet:Yes
> ip lanDNSRes -i 1 -a 172.16.4.10 -s 1
% Configure Set1's IP:172.16.4.10
% Configure Set1's Idx:3 ReplyOnlySameSubnet:Yes
>
```

## Telnet Command: ip dnsforward

This command is used to set LAN DNS profile for conditional DNS forwarding.

### Syntax

ip dnsforward [-<command> <parameter> | ... ]

### Syntax Description

| Parameter                            | Description                                                                                                              |
|--------------------------------------|--------------------------------------------------------------------------------------------------------------------------|
| [<command><br><parameter> ...]       | The available commands with parameters are listed below.<br>[...] means that you can Enter several commands in one line. |
| -a <IP Address/Domain Name>          | Set forwarded DNS server IP Address or domain name.<br><IP Address/Domain Name>: Enter an IP address or the domain name. |
| -d <DNS server mapping index number> | Delete the selected LAN DNS profile.<br><DNS server mapping index number>: Enter the index number.                       |
| -e <0/1>                             | 0: disable this function.<br>1: enable this function.                                                                    |
| -i <profile setting index number>    | Type the index number of the profile.<br><profile setting index number>: Enter the index number.                         |
| -l                                   | List the content of LAN DNS profile (including domain name, IP address and message).                                     |
| -n <domain name>                     | Set domain name.                                                                                                         |
| -p <profile name>                    | Set profile name for LAN DNS.                                                                                            |
| -r                                   | Reset the settings for selected profile.                                                                                 |
| -R                                   | Set to factory default setting.                                                                                          |

### Example

```
> ip dnsforward -i 1 -n ftp.drayTek.com
% Configure Set1's DomainName:ftp.drayTek.com
> ip dnsforward -i 1 -a 172.16.1.1
% Configure Set1's IP:172.16.1.1
> ip dnsforward -i 1 -l
% Idx: 1
% State: Disable
% Profile: test
% Domain Name: ftp.drayTek.com
% DNS Server IP: 172.16.1.1
>
```

## Telnet Command: ip spoofdef

This command is used to enable/disable the IP Spoofing Defense.

### Syntax

ip spoofdef <WAN/LAN><0/1>

### Syntax Description

| Parameter | Description                                                          |
|-----------|----------------------------------------------------------------------|
| <WAN/LAN> | It means to block IP packet from WAN/LAN with inconsistent source IP |

|       |                                                     |
|-------|-----------------------------------------------------|
|       | address.                                            |
| <0/1> | 0: Disable the function.<br>1: Enable the funciton. |

## Example

```
> ip spoofdef WAN 1
Setting saved:
>
```

## Telnet Command: ip6 addr

This command allows users to set the IPv6 address for your router.

### Syntax

```
ip6 addr -s <prefix> <prefix-length> <LAN1/..LAN8/DMZ/
WAN1/..WAN4/USB1/USB2/VPN1/..VPN64>
ip6 addr -d <prefix> <prefix-length><LAN1/..LAN8/DMZ/
WAN1/..WAN4/USB1/USB2/VPN1/..VPN64>
ip6 addr -a<LAN1/..LAN8/DMZ/ WAN1/..WAN4/USB1/USB2/VPN1/..VPN64> -u
ip6 addr -v<LAN1/..LAN8/DMZ/ WAN1/..WAN4/USB1/USB2>
ip6 addr -t <old-prefix><old-prefix-length><new-prefix> <new-prefix-length>
<LAN1/..LAN8/DMZ/ WAN1/..WAN4/USB1/USB2>
ip6 addr -o <1/2>
ip6 addr -o 3 <prefix> <prefix-length> <WAN1/WAN2/USB1/USB2>
ip6 addr -l <prefix> <prefix-length> <LAN1/..LAN8/DMZ>
ip6 addr <-p/-b> <prefix> <prefix-length> <WAN1/..WAN4/USB1/USB2>
ip6 addr -x <LAN1/..LAN8/DMZ>
ip6 addr -c <LAN1/..LAN8/DMZ>
ip6 addr -e <type> < LAN1/..LAN8/DMZ>
```

### Syntax Description

| Parameter                                                                         | Description                                                                                                                                                                                                                                                                                                         |
|-----------------------------------------------------------------------------------|---------------------------------------------------------------------------------------------------------------------------------------------------------------------------------------------------------------------------------------------------------------------------------------------------------------------|
| -s <prefix> <prefix-length> <LAN1/..LAN8/DMZ/ WAN1/..WAN4/USB1/USB2/VPN1/..VPN64> | It means to add a static ipv6 address.<br><prefix>: It means to enter the prefix number of IPv6 address.<br><prefix-length>: It means to enter a fixed value as the length of the prefix.<br><LAN1/..LAN8/DMZ/ WAN1/..WAN4/USB1/USB2/VPN1/..VPN64>: It means to specify LAN/WAN/USB/VPN interface for such address. |
| -d <prefix> <prefix-length> <LAN1/..LAN8/DMZ/ WAN1/..WAN4/USB1/USB2/VPN1/..VPN64> | It means to delete an ipv6 address.<br><prefix>: It means to enter the prefix number of IPv6 address.<br><prefix-length>: It means to enter a fixed value as the length of the prefix.<br><LAN1/..LAN8/DMZ/ WAN1/..WAN4/USB1/USB2/VPN1/..VPN64>: It means to specify LAN/WAN/USB/VPN interface for such address.    |
| -a < LAN1/..LAN8/DMZ/ WAN1/..WAN4/USB1/USB2/VPN1/..VPN64> -u                      | It means to show current address(es) status.<br><LAN1/..LAN8/DMZ/ WAN1/.. WAN4/USB1/USB2/VPN1/..VPN64>: It means to specify LAN/WAN/USB/VPN interface.<br><-u>: It means to show unicast address only.                                                                                                              |
| -v <LAN1/..LAN8/ WAN1/..WAN4/USB1/USB2>                                           | It means to show prefix list status.                                                                                                                                                                                                                                                                                |

|                                                                                                                                                              |                                                                                                                                                                                                                                                                                                                                                                                                                                                                                                                        |
|--------------------------------------------------------------------------------------------------------------------------------------------------------------|------------------------------------------------------------------------------------------------------------------------------------------------------------------------------------------------------------------------------------------------------------------------------------------------------------------------------------------------------------------------------------------------------------------------------------------------------------------------------------------------------------------------|
| <p>-t<br/>&lt;old-prefix&gt;&lt;old-prefix-length&gt;&lt;new-prefix&gt;<br/>&lt;new-prefix-length&gt;<br/>&lt;LAN1/..LAN8<br/>/WAN1/..WAN4/USB1/USB2&gt;</p> | <p>It means to update WAN static IPv6 address table.<br/>&lt;old-prefix&gt;: It means to enter the prefix number of IPv6 address.<br/>&lt;old-prefix-length&gt;: It means to enter a fixed value as the length of the prefix.<br/>&lt;new-prefix&gt;: It means to enter the prefix number of IPv6 address.<br/>&lt;new-prefix-length&gt;: It means to enter a fixed value as the length of the prefix.<br/>&lt;LAN1/..LAN8/WAN1/..WAN4/USB1/USB2 &gt;: It means to specify LAN/WAN/USB interface for such address.</p> |
| <p>-o &lt;1/2&gt;</p>                                                                                                                                        | <p>&lt;1&gt;: It means to show old prefix list.<br/>&lt;2&gt;: It means to send old prefix option by RA.</p>                                                                                                                                                                                                                                                                                                                                                                                                           |
| <p>-o &lt;3&gt; &lt;prefix&gt;<br/>&lt;prefix-length&gt;<br/>&lt;WAN1/..WAN4/USB1/USB2&gt;</p>                                                               | <p>&lt;3&gt;: It means to set old prefix.<br/>&lt;prefix&gt;: It means to enter the prefix number of IPv6 address.<br/>&lt;prefix-length&gt;: It means to enter a fixed value as the length of the prefix.<br/>&lt;WAN1/..WAN4/USB1/USB2 &gt;: It means to specify a WAN/USB interface for such address.</p>                                                                                                                                                                                                           |
| <p>-l &lt;prefix&gt; &lt;prefix-length&gt; &lt;LAN1/..LAN8/DMZ&gt;</p>                                                                                       | <p>It means to add a ULA.<br/>&lt;prefix&gt;: It means to enter the prefix number of IPv6 address.<br/>&lt;prefix-length&gt;: It means to enter a fixed value as the length of the prefix.<br/>&lt;LAN1/..LAN8/DMZ&gt;: It means to specify a LAN interface for such address.</p>                                                                                                                                                                                                                                      |
| <p>-p/-b &lt;prefix&gt;<br/>&lt;prefix-length&gt;<br/>&lt;WAN1/..WAN4/USB1/USB2&gt;</p>                                                                      | <p>It means to add/delete an prefix to/from prefix list.<br/>p: Add a prefix to a prefix list.<br/>b: Delete a prefix from a prefix list.<br/>&lt;prefix&gt;: It means to enter the prefix number of IPv6 address.<br/>&lt;prefix-length&gt;: It means to enter a fixed value as the length of the prefix.<br/>&lt;WAN1/..WAN4/USB1/USB2 &gt;: It means to specify a WAN/USB interface for such address.</p>                                                                                                           |
| <p>-x &lt;LAN1/..LAN8/DMZ&gt;</p>                                                                                                                            | <p>It means to generate a ULA automatically.<br/>&lt;LAN1/..LAN8/DMZ&gt;: It means to specify a LAN interface.</p>                                                                                                                                                                                                                                                                                                                                                                                                     |
| <p>-c &lt;LAN1/..LAN8/DMZ&gt;</p>                                                                                                                            | <p>It means to delete a ULA .<br/>&lt;LAN1/..LAN8/DMZ&gt;: It means to specify a LAN interface.</p>                                                                                                                                                                                                                                                                                                                                                                                                                    |
| <p>-e &lt;type&gt;<br/>&lt;LAN1/..LAN8/DMZ&gt;</p>                                                                                                           | <p>It means to set ULA type.<br/>&lt;type&gt;: 0, disable; 1, static; 2, auto<br/>&lt;LAN1/..LAN8/DMZ&gt;: It means to specify a LAN interface.</p>                                                                                                                                                                                                                                                                                                                                                                    |

## Example

```

> ip6 addr -a
LAN
Unicast Address:
FE80::250:7FFF:FE00:0/64 (Link)
Multicast Address:
FF02::2
FF02::1:FF00:0
FF02::1
...
...

```

## Telnet Command: ip6 dhcp req\_opt

This command is used to configure option-request settings for DHCPv6 client.

### Syntax

```
ip6 dhcp req_opt <LAN1|..LAN8|DMZ|WAN1|..WAN4|USB1|USB2> <command>  
<parameter>| ...
```

### Syntax Description

| Parameter                                          | Description                                                                                                                  |
|----------------------------------------------------|------------------------------------------------------------------------------------------------------------------------------|
| <i>req_opt</i>                                     | It means option-request.                                                                                                     |
| <i>LAN1 ..LAN8 DMZ WAN1 ..WAN4 USB1 USB2</i>       | It means to specify LAN or WAN interface for such address.                                                                   |
| <i>[&lt;command&gt;<br/>&lt;parameter&gt; ...]</i> | The available commands with parameters are listed below.<br>[...] means that you can Enter several commands in one line.     |
| <i>-a</i>                                          | It means to show current DHCPv6 status.                                                                                      |
| <i>-s</i>                                          | It means to ask the SIP.                                                                                                     |
| <i>-S</i>                                          | It means to ask the SIP name.                                                                                                |
| <i>-d</i>                                          | It means to ask the DNS setting.                                                                                             |
| <i>-D</i>                                          | It means to ask the DNS name.                                                                                                |
| <i>-n</i>                                          | It means to ask NTP.                                                                                                         |
| <i>-i</i>                                          | It means to ask NIS.                                                                                                         |
| <i>-I</i>                                          | It means to ask NIS name.                                                                                                    |
| <i>-p</i>                                          | It means to ask NISP.                                                                                                        |
| <i>-P</i>                                          | It means to ask NISP name.                                                                                                   |
| <i>-b</i>                                          | It means to ask BCMCS.                                                                                                       |
| <i>-B</i>                                          | It means to ask BCMCS name.                                                                                                  |
| <i>-r</i>                                          | It means to ask refresh time.                                                                                                |
| <i>Parameter</i>                                   | 1: the parameter related to the request will be displayed.<br>0: the parameter related to the request will not be displayed. |

### Example

```
> ip6 dhcp req_opt WAN2 -S 1  
> ip6 dhcp req_opt WAN2 -r 1  
> ip6 dhcp req_opt WAN2 -a  
% Interface WAN2 is set to request following DHCPv6 options:  
%   sip name  
>
```

## Telnet Command: ip6 dhcp client

This command allows you to use DHCPv6 protocol to obtain IPv6 address from server.

### Syntax

```
ip6 dhcp client <WAN1|...|WAN4|USB1|USB2> [-<command> <parameter>| ...
```

### Syntax Description

| Parameter | Description |
|-----------|-------------|
|-----------|-------------|

|                                |                                                                                                                            |
|--------------------------------|----------------------------------------------------------------------------------------------------------------------------|
| <i>client</i>                  | It means the dhcp client settings.                                                                                         |
| [<command><br><parameter> ...] | The available commands with parameters are listed below.<br>[...] means that you can type in several commands in one line. |
| -a                             | It means to show current DHCPv6 status.                                                                                    |
| -p <IAID>                      | It means to request identity association ID for Prefix Delegation.                                                         |
| -n <IAID>                      | It means to request identity association ID for Non-temporary Address.                                                     |
| -t <time>                      | It means to set solicit interval.<br><time>: 0 ~ 7 seconds (default value is 0).                                           |
| -c <parameter>                 | It means to send rapid commit to server.<br>1: Enable<br>0: Disable                                                        |
| -i <parameter>                 | It means to send information request to server.<br>1: Enable<br>0: Disable                                                 |
| -e <parameter>                 | It means to enable or disable the DHCPv6 client.<br>1: Enable<br>0: Disable                                                |
| -m <parameter>                 | It means to enable/disable server DUID set by Link layer and time.<br>1: Enable<br>0: Disable                              |
| -d                             | It means to display the client DUID.                                                                                       |
| -A <parameter>                 | It means to set authentication protocol.<br>0: Undefine<br>2: delayed protocol                                             |
| -R <parameter>                 | It means to set realm value (max: 31 characters) in delayed protocol.<br><parameter>: Enter a string.                      |
| -S <parameter>                 | It means to set shared secret (max: 31 characters) in delayed protocol.<br><parameter>: Enter a string.                    |
| -K <parameter>                 | It means to set key ID (1~65535) in delayed protocol.<br><parameter>: Enter a number.                                      |

### Example

```
> ip6 dhcp client WAN2 -d
Client DUID = 000300011449bc0a6241
>
```

### Telnet Command: ip6 dhcp server

This command allows you to configure DHCPv6 server.

#### Syntax

```
ip6 dhcp server [-<command> <parameter>| ... ]
```

#### Syntax Description

| Parameter | Description |
|-----------|-------------|
|-----------|-------------|

|                                                                       |                                                                                                                                       |
|-----------------------------------------------------------------------|---------------------------------------------------------------------------------------------------------------------------------------|
| <i>server</i>                                                         | It means the dhcp server settings.                                                                                                    |
| [<command><br><parameter> ...]                                        | The available commands with parameters are listed below.<br>[...] means that you can Enter several commands in one line.              |
| -a                                                                    | It means to show current DHCPv6 status.                                                                                               |
| -b                                                                    | It means to show current DHCPv6 IP assignment table.                                                                                  |
| -n <name>                                                             | It means to set a pool name.                                                                                                          |
| -c <parameter>                                                        | It means to send rapid commit to server.<br>1: Enable<br>0: Disable                                                                   |
| -e <parameter>                                                        | It means to enable or disable the DHCPv6 server.<br>1: Enable<br>0: Disable                                                           |
| -t <time>                                                             | It means to set prefer lifetime.                                                                                                      |
| -y <time>                                                             | It means to set valid lifetime.                                                                                                       |
| -u <time>                                                             | It means to set T1 time.                                                                                                              |
| -o <time>                                                             | It means to set T2 time.                                                                                                              |
| -i <pool_min_addr>                                                    | It means to set the start IPv6 address of the address pool.                                                                           |
| -x <pool_max_addr>                                                    | It means to set the end IPv6 address of the address pool.                                                                             |
| -R                                                                    | It means to send reconfigure packet to the client.                                                                                    |
| -r <0/1>                                                              | It means to disable (0) or enable (1) the auto range.                                                                                 |
| -N <0/1>                                                              | It means to disable (0) or enable (1) the random address allocation.                                                                  |
| -d <addr>                                                             | It means to set the first DNS IPv6 address.<br><addr> : Enter an IPv6 address.                                                        |
| -D <addr>                                                             | It means to set the second DNS IPv6 address.<br><addr> : Enter an IPv6 address.                                                       |
| -m <1/0>                                                              | It means to enable(1) or disable (0) the server DUID set by Link Layer and Time.                                                      |
| -q <name>                                                             | It means to set DNS domain search list.<br><name>: Enter a name.                                                                      |
| -z <0/1>                                                              | It means to disable (0) or enable (1) the DHCP PD.                                                                                    |
| <i>pdadd</i> <suffix> <prefix_len><br><client linklocal><client DUID> | It means to add PD node.                                                                                                              |
| <i>pddel</i> <PD index>                                               | It means to delete PD node.<br><PD index>: Enter a number.                                                                            |
| -A <parameter>                                                        | It means to set authentication protocol.<br><parameter>: Enter 0, 2 or 3.<br>0: Undefine<br>2: delayed protocol<br>3: Reconfigure key |
| -M <parameter>                                                        | It means to set realm value (max: 31 characters) in delayed protocol.<br><parameter>: Enter a string.                                 |
| -S <parameter>                                                        | It means to set shared secret (max: 31 characters) in delayed protocol.<br><parameter>: Enter a string.                               |



|                             |                                                                                       |
|-----------------------------|---------------------------------------------------------------------------------------|
| <i>-K &lt;parameter&gt;</i> | It means to set key ID (1-65535) in delayed protocol.<br><parameter>: Enter a number. |
|-----------------------------|---------------------------------------------------------------------------------------|

### Example

```
> ip6 dhcp server LAN1 pdadd 11:22:33 64 fe80::e202:1bff:fe65:4084
000100011d2ce39a00e06f25c839
%      Add to PD list success!
%%    PD status : invalid, no prefix available.
>
```

## Telnet Command: ip6 internet

This command allows you to configure settings for accessing Internet.

### Syntax

`ip6 internet -W n -M n [-<command> <parameter> | ... ]`

### Syntax Description

| Parameter                                          | Description                                                                                                                                                                                                                       |
|----------------------------------------------------|-----------------------------------------------------------------------------------------------------------------------------------------------------------------------------------------------------------------------------------|
| <i>[&lt;command&gt;<br/>&lt;parameter&gt; ...]</i> | The available commands with parameters are listed below.<br>[...] means that you can type in several commands in one line.                                                                                                        |
| <i>-W n</i>                                        | W means to set WAN interface and n means different selections.<br>Default is WAN1.<br><br>n=1: WAN1<br>n=2: WAN2<br>n=3: WAN3<br>.<br>.<br>n=X: WANx                                                                              |
| <i>-M n</i>                                        | M means to set Internet Access Mode (Mandatory) and n means different modes (represented by 0 - 5)<br><br>n= 0: Offline,<br>n=1: PPP,<br>n=2: TSPC,<br>n=3: AICCU,<br>n=4: DHCPv6,<br>n=5: Static<br>n=6: 6in4-Static<br>n=7: 6rd |
| <i>-m n</i>                                        | It means to set IPv6 MTU.<br>N = any value (0 means "unspecified").                                                                                                                                                               |
| <i>6rd</i>                                         |                                                                                                                                                                                                                                   |
| <i>-C &lt;n&gt;</i>                                | It means to set 6rd connection mode.<br>n=0: Auto<br>n=1: Static                                                                                                                                                                  |
| <i>-s &lt;server&gt;</i>                           | It means to set 6rd IPv4 Border Relay.<br><server>: Enter a string.                                                                                                                                                               |
| <i>-m &lt;n&gt;</i>                                | It means to set 6rd IPv4 address mask length.<br><n>: Enter a number.                                                                                                                                                             |
| <i>-p &lt;prefix&gt;</i>                           | It means to set IPv6 prefix for 6rd connection.                                                                                                                                                                                   |

|                          |                                                                                                                             |
|--------------------------|-----------------------------------------------------------------------------------------------------------------------------|
|                          | <prefix>: Enter a prefix number of IPv6 address.                                                                            |
| -l <n>                   | It means to set the prefix length for 6rd connection.<br><n>: It means to enter a fixed value as the length of the prefix.  |
| <i>6in4</i>              |                                                                                                                             |
| -s <server>              | It means to set 6in4 remote endpoint IPv4 address.                                                                          |
| -I <IPv6 Addr>           | It means to set the IPv6 address for 6in4 connection.                                                                       |
| -P <n>                   | It means to set IPv6 WAN prefix length for 6in4 connection.                                                                 |
| -p <prefix>              | It means to set 6in4 LAN Routed Prefix.                                                                                     |
| -l <n>                   | It means to set 6in4 LAN Routed Prefix length.                                                                              |
| -T <n>                   | It means to set 6in4 Tunnel TTL.                                                                                            |
| <i>TSPC/AICCU</i>        |                                                                                                                             |
| -u <username>            | It means to set username (max. 63 characters).<br><username>: Enter a string.                                               |
| -P <password>            | It means to set Password (max. 63 characters).<br><password>: Enter a password.                                             |
| -s <server>              | It means to set Tunnel Server IP.<br><server>: Enter an IPv4 Address or URL (max. 63 characters)                            |
| <i>AICCU</i>             |                                                                                                                             |
| -p <prefix>              | It means to set Subnet Prefix (AICCU).<br><prefix>: Enter a prefix number of IPv6 address.                                  |
| -l <n>                   | It means to set Subnet Prefix length (AICCU).<br><n>: Enter a number.                                                       |
| -o <1/0>                 | It means to set AICCU always on.<br>1: on<br>0: off                                                                         |
| -f                       | It means to set AICCU tunnel ID.                                                                                            |
| <i>Static</i>            |                                                                                                                             |
| -w <addr>                | It means to set Default Gateway.<br><addr>: Enter an IPv6 address.                                                          |
| <i>Others</i>            |                                                                                                                             |
| -d <server>              | It means to set 1st DNS Server IP.<br><server>: Enter an IPv6 address.                                                      |
| -D <server>              | It means to set 2nd DNS Server IP.<br><server>: Enter an IPv6 address.                                                      |
| -t <dhcp/ra/none>        | It means to set ipv6 PPP WAN test mode for DHCP or RA.<br><dhcp/ra/none> : Enter dhcp, ra or none.                          |
| -V                       | It means to view IPv6 Internet Access Profile.                                                                              |
| -k                       | It means to dial the Tunnel on the WAN.                                                                                     |
| -j                       | It means to drop the Tunnel on the WAN.                                                                                     |
| -r n                     | It means to set Prefix State Machine RA timeout.                                                                            |
| -c n                     | It means to set Prefix State Machine DHCPv6 Client timeout.                                                                 |
| -q <0/1/2>               | It means to set WAN detection mode.<br>0:NS Detect<br>1:Ping Detect<br>2:Always On                                          |
| -z <value>               | It means to set Ping Detect TTL (0-255).<br><value>: Enter 0-255.                                                           |
| -x <hostname/ IPv6 addr> | It means to set Ping Detect Host (hostname or IPv6 address).<br><hostname/ipv6 addr> : Enter a hostname or an IPv6 address. |
| -i <value>               | It means to set ipv6 connection interval.<br><value>: Enter a number (1500-60000 (unit:10ms)).                              |
| -b <0/1>                 | It means to enable DNSv6 based on DHCPv6.<br>1 = on<br>0 = off                                                              |
| -R <0/1>                 | It means to Enable RIPng.<br>1 = on<br>0 = off                                                                              |

## Example

```
> ip6 internet -W 2 -M 2 -u 88886666 -p draytek123456 -s amsterdam.freenet6.net
This setting will take effect after rebooting.
Please use "sys reboot" command to reboot the router.
> system reboot
```

## Telnet Command: ip6 neigh

This command allows you to display IPv6 neighbour table.

### Syntax

`ip6 neigh -s <inet6_addr> <eth_addr> <LAN1/..LAN8/DMZ/WAN1/..WAN4/USB1/USB2>`

`ip6 neigh -d <inet6_addr> <LAN1/..LAN8/DMZ/WAN1/..WAN4/USB1/USB2>`

`ip6 neigh -a <inet6_addr> <-N LAN1/..LAN8/DMZ/WAN1/..WAN4/USB1/USB2>`

### Syntax Description

| Parameter                                                                                         | Description                                                                                                                                                                                     |
|---------------------------------------------------------------------------------------------------|-------------------------------------------------------------------------------------------------------------------------------------------------------------------------------------------------|
| <code>-s &lt;inet6_addr&gt; &lt;eth_addr&gt; &lt;LAN1/..LAN8/DMZ/WAN1/..WAN4/USB1/USB2&gt;</code> | It means to add a neighbour.<br><inet6_addr>: Enter an IPv6 address.<br><eth_addr>: Enter a submask address.<br><LAN1/..LAN8/DMZ/WAN1/..WAN4/USB1/USB2>: Specify an interface for the neighbor. |
| <code>-d &lt;inet6_addr&gt; &lt;LAN1/..LAN8/DMZ/WAN1/..WAN4/USB1/USB2&gt;</code>                  | It means to delete a neighbour.<br><inet6_addr>: Enter an IPv6 address.<br>< LAN1/..LAN8/DMZ/WAN1/..WAN4/USB1/USB2>: Specify an interface for the neighbor.                                     |
| <code>-a &lt;inet6_addr&gt; &lt;-N LAN1/..LAN8/DMZ/WAN1/..WAN4/USB1/USB2&gt;</code>               | It means to show neighbour status.<br><inet6_addr>: Enter an IPv6 address.<br><LAN1/..LAN8/DMZ/WAN1/..WAN4/USB1/USB2>: Specify an interface for the neighbor.                                   |

### Example

```
> ip6 neigh -s 2001:2222:3333::1111 00:50:7F:11:ac:22:WAN2
% Neighbour 2001:2222:3333::1111 successfully added!
> ip6 neigh -a
```

| I/F  | ADDR                      | MAC               | STATE     |
|------|---------------------------|-------------------|-----------|
| LAN1 | ::                        |                   | NONE      |
| LAN1 | 2001:2222:3333::1111      |                   | FAILED    |
| LAN1 | FE80::D161:4B76:3314:9E59 | 14-49-bc-0a-8a-b8 | STALE     |
| LAN1 | FF02::1                   | 33-33-00-00-00-01 | CONNECTED |
| NONE |                           |                   |           |

```
>
```

## Telnet Command: ip6 p neigh

This command allows you to add a proxy neighbour.

### Syntax

`ip6 p neigh -s <inet6_addr> <LAN1/..LAN8/DMZ/WAN1/..WAN4/USB1/USB2>`

`ip6 p neigh -d <inet6_addr> <LAN1/..LAN8/DMZ/WAN1/..WAN4/USB1/USB2>`

`ip6 p neigh -a <inet6_addr> <-N LAN1/..LAN8/DMZ/WAN1/..WAN4/USB1/USB2>`

### Syntax Description

| Parameter | Description |
|-----------|-------------|
|-----------|-------------|

|                                                            |                                                                                                                                                                           |
|------------------------------------------------------------|---------------------------------------------------------------------------------------------------------------------------------------------------------------------------|
| -s <inet6_addr><br><LAN1/..LAN8/DMZ/WAN1/..WAN4/USB1/USB2> | It means to add a proxy neighbour.<br><inet6_addr>: Enter an IPv6 address.<br><LAN1/..LAN8/DMZ/WAN1/..WAN4/USB1/USB2>: Specify an interface for the proxy neighbor.       |
| -d <inet6_addr><br><LAN1/..LAN8/DMZ/WAN1/..WAN4/USB1/USB2> | It means to delete a proxy neighbour.<br><inet6_addr>: Enter an IPv6 address.<br><LAN1/..LAN8/DMZ/WAN1/..WAN4/USB1/USB2>: Specify an interface for the proxy neighbor.    |
| -a <inet6_addr> <-N LAN1/..LAN8/DMZ/WAN1/..WAN4/USB1/USB2> | It means to show proxy neighbour status.<br><inet6_addr>: Enter an IPv6 address.<br><LAN1/..LAN8/DMZ/WAN1/..WAN4/USB1/USB2>: Specify an interface for the proxy neighbor. |

## Example

```
> ip6 neigh -s FE80::250:7FFF:FE12:300 LAN1
% Neighbour FE80::250:7FFF:FE12:300 successfully added!
```

## Telnet Command: ip6 route

This command allows you to IPv6 route policy.

### Syntax

```
ip6 route -s <prefix> <prefix-length> <gateway> <LAN1/..LAN8/DMZ/WAN1/..WAN4/USB1/USB2/VPN1/..VPN64> <-D>
```

```
ip6 route -d <prefix> <prefix-length>
```

```
ip6 route -a <LAN1/..LAN8/DMZ/WAN1/..WAN4/USB1/USB2/VPN1/..VPN64>
```

```
ip6 route -/
```

### Syntax Description

| Parameter                                                                                        | Description                                                                                                                                                                                                                                                                                                                                                                                                                                |
|--------------------------------------------------------------------------------------------------|--------------------------------------------------------------------------------------------------------------------------------------------------------------------------------------------------------------------------------------------------------------------------------------------------------------------------------------------------------------------------------------------------------------------------------------------|
| -s <prefix> <prefix-length> <gateway><br><LAN1/..LAN8/DMZ/WAN1/WAN4/USB1/USB2/VPN1/..VPN64> <-D> | It means to add a route.<br><prefix>: It means to enter the prefix number of IPv6 address.<br><prefix length>: It means to enter a fixed value as the length of the prefix.<br><gateway>: It means to enter the gateway of the router.<br><LAN1/..LAN8/DMZ/WAN1/..WAN4/ USB1/USB2/VPN1/..VPN64>: It means to specify LAN or WAN or VPN interface for such address.<br><-D>: It means that such route will be treated as the default route. |
| -d <prefix> <prefix-length>                                                                      | It means to delete a route.<br><prefix>: It means to enter the prefix number of IPv6 address.<br><prefix length>: It means to enter a fixed value as the length of the prefix.                                                                                                                                                                                                                                                             |
| -a<br><LAN1/..LAN8/DMZ/WAN1/..WAN4/USB1/USB2/VPN1/..VPN64>                                       | It means to show the route status.<br><LAN1/..LAN8/DMZ/WAN1/..WAN4/USB1/USB2/VPN1/..VPN64>: It means to specify LAN or WAN or VPN interface for such address.                                                                                                                                                                                                                                                                              |
| -/                                                                                               | It means to clear the routing table.                                                                                                                                                                                                                                                                                                                                                                                                       |

## Example

```
> ip6 route -s FE80::250:7FFF:FE12:500 16 FE80::250:7FFF:FE12:100 LAN1
% Route FE80::250:7FFF:FE12:500/16 successfully added!
> ip6 route -a LAN1

PREFIX/PREFIX-LEN I/F METRIC FLAG NEXT-HOP
```

```

-----
::0.0.0.1/128          LAN1    0 U  ::
FE80::/128           LAN1    0 U  ::
FE80::1649:BCFF:FE0A:6240/128 LAN1    0 U  ::
FE80::/64            LAN1   256 U  ::
FE80::/16            LAN1  1024 UGS FE80::250:7FFF:FE12:100
FF00::/8             LAN1   256 U  ::
>

```

## Telnet Command: ip6 ping

This command allows you to ping an IPv6 address or a host.

### Syntax

**ip6 ping** <IPv6 address/Host> <LAN1/..LAN8/DMZ/WAN1/..WAN4/USB1/USB2> <send count> <data\_size>

### Syntax Description

| Parameter                                    | Description                                            |
|----------------------------------------------|--------------------------------------------------------|
| <i>IPv6 address/Host</i>                     | It means to specify the IPv6 address or host for ping. |
| <i>LAN1/..LAN8/DMZ/WAN1/..WAN4/USB1/USB2</i> | It means to specify an interface for such address.     |
| <i>data_size</i>                             | Ranges from 1 to 1452.                                 |

### Example

```

> ip6 ping 2001:4860:4860::8888 WAN2

Pinging 2001:4860:4860::8888 with 64 bytes of Data:

Receive reply from 2001:4860:4860::8888, time=330ms
Receive reply from 2001:4860:4860::8888, time=330ms
Receive reply from 2001:4860:4860::8888, time=330ms
Receive reply from 2001:4860:4860::8888, time=330ms
Receive reply from 2001:4860:4860::8888, time=330ms

Packets: Sent = 5, Received = 5, Lost = 0 <% loss>
>

```

## Telnet Command: ip6 tracert

This command allows you to trace the routes from the router to the host.

### Syntax

**ip6 tracert** <IPv6 address/Host><LAN1/..LAN8/DMZ/WAN1/..WAN4/USB1/USB2>

### Syntax Description

| Parameter                               | Description                                            |
|-----------------------------------------|--------------------------------------------------------|
| <IPv6 address/Host>                     | It means to specify the IPv6 address or host for ping. |
| <LAN1/..LAN8/DMZ/WAN1/..WAN4/USB1/USB2> | It means to specify an interface for such address.     |

## Example

```
> ip6 tracert 2001:4860:4860::8888
traceroute to 2001:4860:4860::8888, 30 hops max through protocol ICMP
 1 2001:5C0:1400:B::10B8      340 ms
 2 2001:4DE0:1000:A22::1     330 ms
 3 2001:4DE0:A::1           330 ms
 4 2001:4DE0:1000:34::1     340 ms
 5 2001:7F8:1: :A501:5169:1 330 ms
 6 2001:4860::1:0:4B3       350 ms
 7 2001:4860::8:0:2DAF     330 ms
 8 2001:4860::2:0:66E     340 ms
 9 Request timed out.      *
10 2001:4860:4860::8888    350 ms
Trace complete.
>
```

## Telnet Command: ip6 tspc

This command allows you to display TSPC status.

### Syntax

ip6 tspc <ifno>

### Syntax Description

| Parameter   | Description                                                                      |
|-------------|----------------------------------------------------------------------------------|
| <i>ifno</i> | It means the connection interface.<br>Ifno=1 (means WAN1)<br>Info=2 (means WAN2) |

## Example

```
> ip6 tspc 2
Local Endpoint v4 Address : 111.243.177.223
Local Endpoint v6 Address : 2001:05c0:1400:000b:0000:0000:0000:10b9
Router DNS name : 8886666.broker.freenet6.net
Remote Endpoint v4 Address :81.171.72.11
Remote Endpoint v6 Address : 2001:05c0:1400:000b:0000:0000:0000:10b8
Tspc Prefixlen : 56
Tunnel Broker: Amsterdam.freenet.net

Status: Connected

>
```

## Telnet Command: ip6 radvd

This command allows you to enable or disable RADVD server.

### Syntax

ip6 radvd <LAN1/..LAN8/DMZ> <-<command> <parameter>/ ... >

### Syntax Description

| Parameter  | Description                                              |
|------------|----------------------------------------------------------|
| <<command> | The available commands with parameters are listed below. |

|                                  |                                                                                                                                        |
|----------------------------------|----------------------------------------------------------------------------------------------------------------------------------------|
| <i>&lt;parameter&gt;/...&gt;</i> | <i>&lt;...&gt;</i> means that you can Enter several commands in one line.                                                              |
| <i>-s &lt;0/1&gt;</i>            | It means to enable or disable the default lifetime of the RADVD server.<br>1: Enable the RADVD server.<br>0: Disable the RADVD server. |
| <i>-D &lt;0/1/2&gt;</i>          | It means to set RDNSS Disable/Enable/Deploy (0/1/2) when WAN is up.                                                                    |
| <i>-d &lt;lifetme&gt;</i>        | It means to set RA default lifetime.                                                                                                   |
| <i>-i &lt;lifetme&gt;</i>        | It means to set RA min interval time(sec).                                                                                             |
| <i>-I &lt;lifetme&gt;</i>        | It means to set RA MAX interval time(sec).                                                                                             |
| <i>-h &lt;hoplimit&gt;</i>       | It means to set RA hop limit.                                                                                                          |
| <i>-m &lt;mtu/auto&gt;</i>       | It means to set RA MTU, 1280-1500.<br>mtu: auto - auto select MTU from WAN,                                                            |
| <i>-e &lt;time&gt;</i>           | It means to set reachable time.                                                                                                        |
| <i>-a &lt;time/infinity&gt;</i>  | It means to set retransmit timer /infinity.                                                                                            |
| <i>-p &lt;0/1/2&gt;</i>          | It means to set radvd default preference Low/Medium/High.<br>0-low<br>1-medium<br>2-high                                               |
| <i>-v</i>                        | It means to view radvd configuration.                                                                                                  |
| <i>-V</i>                        | It means to view setting in RA.                                                                                                        |
| <i>-L &lt;time/infinity&gt;</i>  | It means to set prefix valid lifetime.                                                                                                 |
| <i>-P &lt;time/infinity&gt;</i>  | It means to set prefix preferred lifetime.                                                                                             |
| <i>-r &lt;num&gt;</i>            | It means to to set RA test for item.<br><i>&lt;num&gt;</i> : 0, 121, 124<br>0: default,<br>121: logo 121,<br>124: logo 124..           |
| <i>-R</i>                        | It means to reload Config and send RA for subnets.                                                                                     |
| <i>-u</i>                        | It means to view MTU on all interfaces.                                                                                                |

## Example

```

> ip6 radvd LAN1 -s 1
% [LAN1] setting !
%   Enable LAN1 radvd OK!
> ip6 radvd LAN1 -d 1800
% [LAN1] setting !
%   Set default lifetime ok: 1800 !
> ip6 radvd LAN1 -V
% [LAN1] setting !
%   Default Lifetime : 0 seconds
%   min interval time: 200 seconds
%   MAX interval time: 600 seconds
%   Hop limit       : 64
%   MTU             : 0
%   Reachable time  : 0
%   Retransmit time : 0
%   Preference      : Medium
>

```

## Telnet Command: ip6 mngt

This command allows you to manage the settings for access list.

## Syntax

`ip6 mngt list`

`ip6 mngt list add <Index> <IPv6 Object Index>|remove <index>|flush`

`ip6 mngt status`

`ip6 mngt <internet/ http/telnet/ping/https/ssh/enforce_https> <on/off>`

## Syntax Description

| Parameter                                                                    | Description                                                                                                                                                                                                                                                                                                                                         |
|------------------------------------------------------------------------------|-----------------------------------------------------------------------------------------------------------------------------------------------------------------------------------------------------------------------------------------------------------------------------------------------------------------------------------------------------|
| <i>list</i>                                                                  | It means to show the setting information of the access list.                                                                                                                                                                                                                                                                                        |
| <i>add &lt;Index&gt; &lt;IPv6 Object Index&gt;  remove &lt;NO.&gt; flush</i> | It means to add an IPv6 address which can be used to execute management through Internet.<br><Index>: 1 to 10. Ten profiles can be set for IPv6 access list.<br><IPv6 Object Index>: It means the index number of IP object (1 to 64) or keyword object (1 to 64) .<br>remove <Index>: It means to remove (delete) the specified IP/Keyword object. |
| <i>flush</i>                                                                 | It means to clear the IPv6 access table.                                                                                                                                                                                                                                                                                                            |
| <i>status</i>                                                                | It means to show the status of IPv6 remote management.                                                                                                                                                                                                                                                                                              |
| <i>internet/<br/>http/telnet/ping/https/ssh<br/>/enforce_https</i>           | These protocols are used for accessing Internet.                                                                                                                                                                                                                                                                                                    |
| <i>on/off</i>                                                                | It means to enable (on) or disable (off) the Internet accessing through http/telnet/ping.                                                                                                                                                                                                                                                           |

## Example

```
> ip6 mngt list add 1 62
%% Set OK.
>
```

## Telnet Command: ip6 online

This command allows you to check the online status of IPv6 LAN /WAN.

## Syntax

`ip6 online <WAN1/..WAN4/USB1/USB2>`

## Syntax Description

| Parameter                            | Description                        |
|--------------------------------------|------------------------------------|
| <i>&lt;WAN1/..WAN4/USB1/USB2&gt;</i> | It means the connection interface. |

## Example

```
> ip6 online WAN1
% WAN1 online status :
% IPv6 WAN1 Disabled
% Default Gateway : ::
% Interface : DOWN
% UpTime : 00:00:00
% IPv6 DNS Server: :: Static
% IPv6 DNS Server: :: Static
% IPv6 DNS Server: :: Static
```



```
% Tx packets = 0, Tx bytes = 0, Rx packets = 0, Rx bytes = 0
% MTU Onlink: 1280 , Config MTU : 0
```

## Telnet Command: ip6 aiccu

This command allows you to set IPv6 settings for WAN interface with connection type of AICCU.

### Syntax

```
ip6 aiccu -i <ifno> -r
ip6 aiccu -i <ifno> -s
```

### Syntax Description

| Parameter | Description                                                                |
|-----------|----------------------------------------------------------------------------|
| <ifno>    | It means the connection interface.<br>1=WAN1<br>2=WAN2                     |
| -r        | It means to remove (delete) the specified index number with IPv6 settings. |
| -s        | It means to display the interface status.                                  |

### Example

```
> ip6 aiccu -i 1 -s
Status: Idle
>
```

## Telnet Command: ip6 ntp

This command allows you to set IPv6 settings for NTP (Network Time Protocols) server.

### Syntax

```
ip6 ntp -h
ip6 ntp -v
ip6 ntp -p <0/1>
```

### Syntax Description

| Parameter | Description                                                                                |
|-----------|--------------------------------------------------------------------------------------------|
| -h        | It is used to display the usage of such command.                                           |
| -v        | It is used to show the NTP state.                                                          |
| -p <0/1>  | It is used to specify NTP server for IPv6.<br>0 - Auto<br>1 - First Query IPv6 NTP Server. |

### Example

```
> ip6 ntp -p 1
% Set NTP Priority: IPv6 First
```

## Telnet Command: ip6 lan

This command allows you to set IPv6 settings for LAN interface.

### Syntax

```
ip6 lan -l n <--<l:w:d:D:m:o:s> <parameter> / ... >
```

## Syntax Description

| Parameter   | Description                                                                                                                 |
|-------------|-----------------------------------------------------------------------------------------------------------------------------|
| -h          | It is used to display the usage of such command.                                                                            |
| -l <n>      | It means to selete LAN interface to be set.<br>n= 1: LAN1<br>n= 2: LAN2, ... x: LANx. Default is LAN1                       |
| -w <n>      | It means to selete WAN interface to be primary interface.<br>n= 0: None,<br>n=1: WAN1 ,<br>n=2: WAN2, ... x: WANx.          |
| -d <server> | It means to set 1st DNS Server IP.<br><server>: Enter the IPv6 Address.                                                     |
| -D <server> | It means to set 2nd DNS Server IP.<br><server>: Enter the IPv6 Address.                                                     |
| -m <n>      | It means to set ipv6 LAN management.<br>n=0:OFF<br>n=1:SLAAC. Default is SLAAC<br>n=2:DHCPv6                                |
| -o <n>      | It means to enable Other option(O-bit) flag. (O-bit is redundant when management is DHCPv6)<br>n=0: Disable<br>n=1: Enable. |
| -e <n>      | It means to add an extension WAN.<br>n: 1: WAN1, 2: WAN2, ... x: WANx.                                                      |
| -E <n>      | It means to delete an extension WAN.<br>n: 1: WAN1 ,2: WAN2, ... x: WANx.                                                   |
| -b <map>    | It means to set bit map(decimal) for extension WAN.<br><map>: 0: WAN1; 1: WAN2, ... n: WAN(n+1).                            |
| -f <n>      | It means to disable IPv6.<br>n=1: Disable IPv6,<br>n=0: Enable IPv6.                                                        |
| -R <n>      | It means to enable /disable RIPng.<br>n=1: Enable RIPng,<br>n=0: Disable RIPng.                                             |
| -s <n>      | It means to show IPv6 LAN setting.<br>n=0:show all. Default is show all.<br>n=1 to 8: LAN1 to LAN8.<br>n=17: DMZ.           |

## Example

```
> ip6 lan -l 1 -w 1 -d 2001:4860:4860::8888 -o 1 -f 0 -s 2
% Set LAN1!

% Set primary WAN1!

% Set 1st DNS server 2001:4860:4860::8888

% Set Other Option Enable!

% [LAN1] support ipv6!

This setting will take effect after rebooting.
Please use "sys reboot" command to reboot the router.

% [LAN2] setting:
% Primary WAN : WAN1
% Management : SLAAC
% Other Option : Disable
% WAN Exten : None
% Subnet ID : 2
% Static IP(0) : ::/0
% [ifno: 0, enable: 0]
% Static IP(1) : ::/0
% [ifno: 0, enable: 0]
% Static IP(2) : ::/0
```

```

% [ifno: 0, enable: 0]
% Static IP(3) : ::/0
% [ifno: 0, enable: 0]
% DNS1 : 2001:4860:4860::8888
% DNS2 : 2001:4860:4860::8844
% ULA Type : OFF
% RIPng : Enable
>

```

## Telnet Command: ip6 session

This command allows you to set sessions limit for IPv6 address.

### Syntax

```

ip6 session on
ip6 session off
ip6 session default <num>
ip6 session status
ip6 session show
ip6 session add <IP1-IP2> <num>
ip6 session del <IP1-IP2> <num>

```

### Syntax Description

| Parameter                 | Description                                                                                                                                 |
|---------------------------|---------------------------------------------------------------------------------------------------------------------------------------------|
| <i>on</i>                 | It means to turn on session limit for each IP.                                                                                              |
| <i>off</i>                | It means to turn off session limit for each IP.                                                                                             |
| <i>default</i> <num>      | It means to set the default number of session num limit.<br><num>: Enter a number.                                                          |
| <i>status</i>             | It means to display the current settings.                                                                                                   |
| <i>show</i>               | It means to display all IP range session limit settings.                                                                                    |
| <i>add</i> <IP1-IP2><num> | <add>: It means to add the session limit for an IPv6 range.<br><IP1-IP2> : Specify a range for IPv6 addresses.<br><num>: Enter a number.    |
| <i>del</i> <IP1-IP2><num> | <del>: It means to delete the session limit for an IPv6 range.<br><IP1-IP2> : Specify a range for IPv6 addresses.<br><num>: Enter a number. |

### Example

```

> ip6 session on
> ip6 session add 2100:ABCD::2-2100:ABCD::10 100
> ip6 session status

IPv6 range:
  2100:ABCD::2 - 2100:ABCD::10 : 100

Current ip6 session limit is turn on

Current default session number is 100

```

## Telnet Command: ip6 bandwidth

This command allows you to set IPv6 settings for bandwidth control.

### Syntax

```

ip6 bandwidth on
ip6 bandwidth off
ip6 bandwidth default <tx_rate> <rx_rate>
ip6 bandwidth status
ip6 bandwidth show

```

```
ip6 bandwidth add <IP1-IP2> <tx><rx><shared>
ip6 bandwidth del <IP1-IP2> <tx><rx><shared>
```

## Syntax Description

| Parameter                                                         | Description                                                                                                                                                                                                                                                                                            |
|-------------------------------------------------------------------|--------------------------------------------------------------------------------------------------------------------------------------------------------------------------------------------------------------------------------------------------------------------------------------------------------|
| <i>on</i>                                                         | It means to turn on bandwidth limit for each IP.                                                                                                                                                                                                                                                       |
| <i>off</i>                                                        | It means to turn off bandwidth limit for each IP.                                                                                                                                                                                                                                                      |
| <i>default &lt;tx_rate&gt; &lt;rx_rate&gt;</i>                    | It means to set the default transmission (tx), receiving (rx) rate of bandwidth limit (0-30000 Kbps/Mbps).<br><tx_rate>: Enter a number.<br><rx_rate>: Enter a number.                                                                                                                                 |
| <i>status</i>                                                     | It means to display the current settings.                                                                                                                                                                                                                                                              |
| <i>show</i>                                                       | It means to display all IP range bandwidth limit settings.                                                                                                                                                                                                                                             |
| <i>add &lt;IP1-IP2&gt;<br/>&lt;tx&gt;&lt;rx&gt;&lt;shared&gt;</i> | <add>: It means to add the bandwidth limit for an IPv6 range.<br><IP1-IP2> - Specify a range for IPv6 addresses.<br><tx><rx>: It means the bandwidth limit for transmission and receive rate.<br><shared>: It means the bandwidth will be shared for the IPv6 range.                                   |
| <i>del &lt;IP1-IP2&gt;<br/>&lt;tx&gt;&lt;rx&gt;&lt;shared&gt;</i> | <del>: It means to delete the bandwidth limit for an IPv6 range by first IP (IP1) or 'del all'.<br><IP1-IP2> - Specify a range for IPv6 addresses.<br><tx><rx>: It means the bandwidth limit for transmission and receive rate.<br><shared>: It means the bandwidth will be shared for the IPv6 range. |

## Example

```
> ip6 bandwidth on
> ip6 bandwidth add 2001:ABCD::2-2001:ABCD::10 512 5M shared
> ip6 bandwidth status

IPv6 range:
  2001:ABCD::2 - 2001:ABCD::10 : Tx:512K Rx:5M shared

Current ip6 Bandwidth limit is turn on

Current default ip6 Bandwidth rate is Tx:2000K Rx:8000K bps
> ip6 bandwidth del 2001:ABCD::2
>
```

## Telnet Command: ipf view

IPF users to view the version of the IP filter, to view/set the log flag, to view the running IP filter rules.

### Syntax

```
ipf view [-VdhrtzZ]
```

### Syntax Description

| Parameter | Description                                              |
|-----------|----------------------------------------------------------|
| -V        | It means to show the version of this IP filter.          |
| -d        | It means to show the running data filter rules.          |
| -h        | It means to show the hit-number of the filter rules.     |
| -r        | It means to show the running call and data filter rules. |
| -t        | It means to display all the information at one time.     |
| -Z        | It means to clear a filter rule's statistics.            |
| -Z        | It means to clear IP filter's gross statistics.          |

### Example

```
> ipf view -V
ipf: IP Filter: v3.3.1 (1852)
Kernel: IP Filter: v3.3.1
Running: yes
Log Flags: 0x6055af1c = block, nomatch
Default: pass all, Logging: available
```

### Telnet Command: ipf set

This command is used to set general rule, filter set and filter rule for firewall.

### Syntax

```
ipf set <Options>
ipf set <SET_NO><Options>
ipf set <SET_NO> rule <RULE_NO><Options>
```

### Syntax Description

| Parameter                                                          | Description                                                                                                                                                                                                                                                                                                                                                                                                                                                |
|--------------------------------------------------------------------|------------------------------------------------------------------------------------------------------------------------------------------------------------------------------------------------------------------------------------------------------------------------------------------------------------------------------------------------------------------------------------------------------------------------------------------------------------|
| <i>ipf set &lt;Options&gt;</i>                                     | It means to set the firewall general setup and default rule.                                                                                                                                                                                                                                                                                                                                                                                               |
| <i>ipf set &lt;SET_NO&gt;&lt;Options&gt;</i>                       | It means to set the firewall filter set including comments and next filter set.                                                                                                                                                                                                                                                                                                                                                                            |
| <i>ipf set &lt;SET_NO&gt; rule &lt;RULE_NO&gt; &lt;Options&gt;</i> | It means to set the firewall rule in filter set.<br>For detailed information, refer to Telnet Command: ipf rule.                                                                                                                                                                                                                                                                                                                                           |
| <i>About ipf set &lt;Options&gt;</i>                               |                                                                                                                                                                                                                                                                                                                                                                                                                                                            |
| -v                                                                 | It means to view the configuration of general set.                                                                                                                                                                                                                                                                                                                                                                                                         |
| -d <p1>                                                            | It means to setup Data Filter.<br><p1>: Specify the index number (1 to 12) of the set profile.<br>To disable the setting, enter "0".                                                                                                                                                                                                                                                                                                                       |
| -p <p1><p2>                                                        | It means to setup actions for packet not matching any rule and whether record syslog.<br><p1>: Type "0" to let packets not matching any rule pass; Type "1" to block the packets not matching any rule.<br><p2>: "0" means the log related to rule matching will not be recorded on Syslog; "1" means the log related to rule matching will be recorded on Syslog.<br>For example, to set pass for packet not matching any rule and enable syslog, -p 0 1. |
| -R <v4/v6> <Enable/Disable>                                        | It means to accept routing packet from WAN.<br><v4/v6>: IPv4 or IPv6.                                                                                                                                                                                                                                                                                                                                                                                      |

|                                |                                                                                                                                                                                                                                                                                                                                                                                                                                                                                                                                                                                                                                                                                                                                                                                                                                                                                                                   |
|--------------------------------|-------------------------------------------------------------------------------------------------------------------------------------------------------------------------------------------------------------------------------------------------------------------------------------------------------------------------------------------------------------------------------------------------------------------------------------------------------------------------------------------------------------------------------------------------------------------------------------------------------------------------------------------------------------------------------------------------------------------------------------------------------------------------------------------------------------------------------------------------------------------------------------------------------------------|
|                                | <p>&lt;Enable/Disable&gt;: Enter 0 (enable) or 1 (disable).<br/>Set Accept routing packet from WAN by IPv4, please enter <i>-R v4 0</i>.</p>                                                                                                                                                                                                                                                                                                                                                                                                                                                                                                                                                                                                                                                                                                                                                                      |
| <i>-L &lt;p1&gt;</i>           | <p>It means to enable or disable the Strict Security Firewall function.<br/>&lt;p1&gt;: Enter 1(enable) or 0 (disable).</p>                                                                                                                                                                                                                                                                                                                                                                                                                                                                                                                                                                                                                                                                                                                                                                                       |
| <i>-C &lt;p1&gt;</i>           | <p>It means to setup Code Page.<br/>&lt;p1&gt;: Enter a code page number (0 to 20). For example, ipf set -C 20.</p> <ol style="list-style-type: none"> <li>0. None</li> <li>1. ANSI(1250)-Central Europe</li> <li>2. ANSI(1251)-Cyrillic</li> <li>3. ANSI(1252)-Latin I</li> <li>4. ANSI(1253)-Greek</li> <li>5. ANSI(1254)-Turkish</li> <li>6. ANSI(1255)-Hebrew</li> <li>7. ANSI(1256)-Arabic</li> <li>8. ANSI(1257)-Baltic</li> <li>9. ANSI(1258)-Viet Nam</li> <li>10. OEM(437)-United States</li> <li>11. OEM(850)-Multilingual Latin I</li> <li>12. OEM(860)-Portuguese</li> <li>13. OEM(861)-Icelandic</li> <li>14. OEM(863)-Canadian French</li> <li>15. OEM(865)-Nordic</li> <li>16. ANSI/OEM(874)-Thai</li> <li>17. ANSI/OEM(932)-Japanese Shift-JIS</li> <li>18. ANSI/OEM(936)-Simplified Chinese GBK</li> <li>19. ANSI/OEM(949)-Korean</li> <li>20. ANSI/OEM(950)-Traditional Chinese Big5</li> </ol> |
| <i>-M &lt;p1&gt;&lt;p2&gt;</i> | <p>It means to setup APP Enforcement and Syslog.<br/>&lt;p1&gt;: Enter a number (0 to 32). In which, 0 means none; 1 to 32 mens the index number of the profile.<br/>&lt;p2&gt;: "0" means the log related to APP Enforcement will not be recorded on Syslog; "1" means the log related to APP Enforcement will be recorded on Syslog.</p>                                                                                                                                                                                                                                                                                                                                                                                                                                                                                                                                                                        |
| <i>-U &lt;p1&gt;&lt;p2&gt;</i> | <p>It means to setup URL Content Filter for packets not matching any rule.<br/>&lt;p1&gt;: Enter a number (0 to 8). In which, 0 means none; 1 to 8 mens the index number of the profile.<br/>&lt;p2&gt;: "0" means the log related to URL Content Filter will not be recorded on Syslog; "1" means the log related to URL Content Filter will be recorded on Syslog.</p>                                                                                                                                                                                                                                                                                                                                                                                                                                                                                                                                          |
| <i>-W &lt;p1&gt;&lt;p2&gt;</i> | <p>It means to setup Web Content Filter for packets not matching any rule.<br/>&lt;p1&gt;: Enter a number (0 to 8). In which, 0 means none; 1 to 8 mens the index number of the profile.<br/>&lt;p2&gt;: "0" means the log related to Web Content Filter will not be recorded on Syslog; "1" means the log related to Web Content Filter will be recorded on Syslog.</p>                                                                                                                                                                                                                                                                                                                                                                                                                                                                                                                                          |
| <i>-D &lt;p1&gt;&lt;p2&gt;</i> | <p>It means to setup DNS Filter for packets not matching any rule.<br/>&lt;p1&gt;: Enter a number (0 to 8). In which, 0 means none; 1 to 8 mens the index number of the profile.<br/>&lt;p2&gt;: "0" means the log related to DNS Filter will not be recorded on Syslog; "1" means the log related to DNS Filter will be recorded on Syslog.</p>                                                                                                                                                                                                                                                                                                                                                                                                                                                                                                                                                                  |

|                                                    |                                                                                                                                                                                                                                                                                              |
|----------------------------------------------------|----------------------------------------------------------------------------------------------------------------------------------------------------------------------------------------------------------------------------------------------------------------------------------------------|
| -a <p1>                                            | It means to configure the advanced settings.                                                                                                                                                                                                                                                 |
| -f <p1>                                            | It means to accept large incoming fragmented UDP or ICMP packets.<br><p1>: Enter 1(enable) or 0 (disable).                                                                                                                                                                                   |
| -t <p1>                                            | It means to enable or disable the Transparent Mode.<br><p1>: Enter 1(enable) or 0 (disable).                                                                                                                                                                                                 |
| -E <p1><p2>                                        | It means to set the maximum count for session limitation.<br><p1>: Enter a number (0 to 50000)<br><p2>: "0" means the log related to session control will not be recorded on Syslog; "1" means the log related to session control will be recorded on Syslog.                                |
| -Q <p1><p2>                                        | It means to set the QoS Class.<br><p1>: Enter a number (0 to 4).<br>0: None<br>1: Class 1<br>2: Class 2<br>3: Class 3<br>4: Default Class<br><p2>: "0" means the log related to QoS Class will not be recorded on Syslog; "1" means the log related to QoS Class will be recorded on Syslog. |
| -Y <p1><p2>                                        | It means to set the User Management.<br><p1>: Enter a number (-1 to 2).<br>-1: None<br>0: All<br>1: user object<br>2: user group<br><p2>: 1 to 200(if p1 is set with 1, user object) or 1 to 32(if p1 is set with 2, user group)                                                             |
| -y <p1>                                            | It means the log related to User Management will be or be not recorded on Syslog.<br><p1>: Enter 1(enable) or 0 (disable).                                                                                                                                                                   |
| -w <p1>                                            | It means to set the window size of TCP protocol.<br><p1>: Enter a value (0 to 65535).                                                                                                                                                                                                        |
| -A <p1>                                            | It means to enable or disable the function of packet capture.<br><p1>: Enter 1(enable) or 0 (disable).                                                                                                                                                                                       |
| <i>About ipf set &lt;SET_NO&gt;&lt;Options&gt;</i> |                                                                                                                                                                                                                                                                                              |
| -m <Comments>                                      | It means to set comment for a filter set.<br><Comments>: Enter a description for the filter set.                                                                                                                                                                                             |
| -v                                                 | It means to view the comment and the next filter set.                                                                                                                                                                                                                                        |
| -n <NEXT_SET_NO>                                   | It means to specify the next filter set of current filter set.<br><NEXT_SET_NO>: Enter a number (1 to 12).<br>For example, ipf set 1 -n 2.                                                                                                                                                   |

## Example

```
> ipf set -R "v4 1"
Setting saved.
> ipf set -R "v6 1"
Setting saved.
> ipf set -v
Data Filter: Enable (Start Filter Set = 1)
```

```

Log Flag      : Disable

Actions for packet not matching any rule:
  Pass or Block      : Pass
  CodePage           : ANSI(1252)-Latin I
  Max Sessions Limit: 60000
  Current Sessions  : 0
  Mac Bind IP       : Non-Strict
  QOS Class         : None
  Packet Capture    : Disable
  APP Enforcement   : None
  URL Content Filter: None
  WEB Content Filter: None
  DNS Filter        : None
  Load-Balance policy : Auto-select
-----
CodePage           : ANSI(1252)-Latin I
Window size        : 65535
Session timeout    : 60
DrayTek Banner     : Enable
-----
Accept large incoming fragmented UDP or ICMP packets: Enable
Transparent Mode   : Disable
-----
Block routing packet from WAN:
  [v] IPv4
  [v] IPv6
-----
[v] Enable Strict Security Firewall 1
>

```

## Telnet Command: ipf rule

This command is used to set filter rule for firewall.

### Syntax

```
ipf rule s r [-<command> <parameter> | ...
```

```
ipf rule s r -v
```

### Syntax Description

| Parameter                      | Description                                                                                                                |
|--------------------------------|----------------------------------------------------------------------------------------------------------------------------|
| s                              | It means the Filter Set.<br>s: Enter a value (1 to 12).                                                                    |
| r                              | It means Filter Rule<br>r: Enter a value (1-7).                                                                            |
| [<command><br><parameter> ...] | The available commands with parameters are listed below.<br>[...] means that you can type in several commands in one line. |
| -e <0/1>                       | It means to enable or disable the rule setting.<br>0: disable<br>1:enable                                                  |
| -v                             | It is used to show current filter rule settings.                                                                           |
| -D <value>                     | It means to set the direction of packet flow. It is for Data Filter only.                                                  |



|                                |                                                                                                                                                                                                                                                                                                                                                                                                                                                                                                                                                                                                                                                                                                                                                                                                                                                                                                                                                                                                       |
|--------------------------------|-------------------------------------------------------------------------------------------------------------------------------------------------------------------------------------------------------------------------------------------------------------------------------------------------------------------------------------------------------------------------------------------------------------------------------------------------------------------------------------------------------------------------------------------------------------------------------------------------------------------------------------------------------------------------------------------------------------------------------------------------------------------------------------------------------------------------------------------------------------------------------------------------------------------------------------------------------------------------------------------------------|
|                                | <p>0: LAN/DMZ/RT/VPN -&gt; WAN<br/> 1: WAN -&gt; LAN/DMZ/RT/VPN<br/> 2: LAN/DMZ/RT/VPN -&gt; LAN/DMZ/RT/VPN</p>                                                                                                                                                                                                                                                                                                                                                                                                                                                                                                                                                                                                                                                                                                                                                                                                                                                                                       |
| -I "<e/d><para1, para2,...>"   | <p>It means to set incoming interface.<br/> e: Enable the function.<br/> d: Disable the function.<br/> Para1, para2,...: Available values include all, LAN1, LAN2,...LAN8, RT, VPN, WAN1, WAN2,...WAN9<br/> Example: &gt; ipf rule 3 1 -e 1 -I "e LAN1"</p>                                                                                                                                                                                                                                                                                                                                                                                                                                                                                                                                                                                                                                                                                                                                           |
| -O "<e/d><para1, para2,...>"   | <p>It means to set outgoing interface.<br/> e: Enable the function.<br/> d: Disable the function.<br/> Para1, para2,...: Available values include all, LAN1, LAN2,...LAN8, RT, VPN, WAN1, WAN2,...WAN9<br/> Exampe: &gt; ipf rule 3 1 -e 1 -O "e LAN2"</p>                                                                                                                                                                                                                                                                                                                                                                                                                                                                                                                                                                                                                                                                                                                                            |
| -s "o/o6/g/g6/c <field> <obj>" | <p>It means to specify source IP object, IP group.<br/> o: Indicates "IPv4 object".<br/> o6: Indicates IPv6 object".<br/> g: Indicates "IPv4 group".<br/> g6: Indicates "IPv6 group".<br/> c: Indicates country object.<br/> field: Indicates the quantity of objects/groups that can be set for this rule at one time.<br/> -2 object profiles are allowed for IPv4<br/> -2 group profiles are allowed for IPv4 group<br/> -3 object profiles are allowed for IPv6<br/> -1 group profiles is allowed for IPv6 group<br/> obj : indicates index number of object or index number of group.<br/> -Range for IPv4, from 1 to 192, 0 means none.<br/> -Range for IPv4 group, from 1 to 32, 0 means none.<br/> -Range for IPv6, from 1 to 64, 0 means none.<br/> -Range for IPv6 group, from 1 to 32, 0 means none.<br/> -Ranges for country object, from 1 to 32.<br/> For example, -s "o 1 2" means IPv4 object profile 1 and 2 are set as souce IP.<br/> Exampe: &gt; ipf rule 3 1 -e 1 -s "o 1 2"</p> |
| -d "o/o6/g/g6/c <field> <obj>" | <p>It means to specify destination IP object, IP group.<br/> o: Indicates "IPv4 object".<br/> o6: Indicates IPv6 object".<br/> g: Indicates "IPv4 group".<br/> g6: Indicates "IPv6 group".<br/> c: Indicates country object.<br/> field: Indicates the quantity of objects/groups can be set for this rule at one time.<br/> -2 object profiles are allowed for IPv4<br/> -2 group profiles are allowed for IPv4 group<br/> -3 object profiles are allowed for IPv6<br/> -1 group profiles is allowed for IPv6 group<br/> obj : indicates index number of object or index number of group.<br/> -Range for IPv4, from 1 to 192, 0 means none.<br/> -Range for IPv4 group, from 1 to 32, 0 means none.<br/> -Range for IPv6, from 1 to 64, 0 means none.<br/> -Range for IPv6 group, from 1 to 32, 0 means none.</p>                                                                                                                                                                                   |

|                                                                                                           |                                                                                                                                                                                                                                                                                                                                                                                                                                                                                                                                                                                                                                                                                                      |
|-----------------------------------------------------------------------------------------------------------|------------------------------------------------------------------------------------------------------------------------------------------------------------------------------------------------------------------------------------------------------------------------------------------------------------------------------------------------------------------------------------------------------------------------------------------------------------------------------------------------------------------------------------------------------------------------------------------------------------------------------------------------------------------------------------------------------|
|                                                                                                           | <p>-Range for country object, from 1 to 32.<br/> For example, -s "o 1 2" means IPv4 object profile 1 and 2 are set as destination IP.<br/> Exampe: &gt; ipf rule 3 1 -e 1 -d "o 2 2"</p>                                                                                                                                                                                                                                                                                                                                                                                                                                                                                                             |
| <p>-d "u &lt;Address Type&gt; &lt;Start IP Address&gt; &lt;End IP Address&gt;   &lt;Address Mask&gt;"</p> | <p>It means to configure destination IP address including address type, start IP address, end IP address and address mask.<br/> u : It means "user defined".<br/> Address Type : Type the number (representing different address type).<br/> 0 : Subnet Address<br/> 1 : Single Address<br/> 2 : Any Address<br/> 3 : Range Address<br/> Example:<br/> Set Subnet Address =&gt; -d "u 0 192.168.1.10 255.255.255.0"<br/> Set Single Address =&gt; -d "u 1 192.168.1.10 "<br/> Set Any Address =&gt; -d "u 2 "<br/> Set Range Address =&gt; -d "u 3 192.168.1.10 192.168.1.15"</p>                                                                                                                    |
| <p>-S o/g &lt;obj&gt;</p>                                                                                 | <p>It means to specify Service Type object.<br/> o : indicates "object" profile.<br/> g: indicates "group" profile.<br/> &lt;obj&gt; : indicates index number of object or index number of group. Available settings range from 1-96. For example, -S "o 1" means the first service type object profile.</p>                                                                                                                                                                                                                                                                                                                                                                                         |
| <p>-S "u &lt;protocol&gt; &lt;source_port_value&gt; &lt;destination_port_vale&gt;"</p>                    | <p>It means to configure advanced settings for Service Type, such as protocol and port range.<br/> u : it means "user defined".<br/> &lt;protocol&gt; : It means TCP(6),UDP(17), TCP/UDP(255), Any(0), ICMP(1), ICMPv6(58), Other(other)<br/> &lt;source_port_value&gt; :<br/> 1 : Port OP, range is 0-3. 0:=, 1:!=, 2:,&gt;, 3:&lt;<br/> 3 : Port range of the Start Port Number, range is 1-65535.<br/> 5 : Port range of the End Port Number, range is 1-65535.<br/> &lt;destination_port_value&gt;:<br/> 2 : Port OP, range is 0-3, 0:==, 1:!=, 2:,&gt;, 3:&lt;<br/> 4 : Port range of the Start Port Number, range is 1-65535.<br/> 6: Port range of the End Port Number, range is 1-65535.</p> |
| <p>-f &lt;value&gt;</p>                                                                                   | <p>It means to set fragment type.<br/> 0 : Don't care.<br/> 1 : Unfragmented.<br/> 2 : Fragmented.<br/> 3 : Too Short</p>                                                                                                                                                                                                                                                                                                                                                                                                                                                                                                                                                                            |
| <p>-F "&lt;Param 0&gt; &lt;Param 1&gt;"</p>                                                               | <p>It means the Filter action you can specify.<br/> &lt;param 0&gt;: Enter the number to set the filter action.<br/> 0 : Pass Immediately.<br/> 1 : Block Immediately.<br/> 2 : Pass if no further match.<br/> 3 : Block if no further match.<br/> &lt;Param 1&gt;: Let the log be recorded on Syslog.<br/> 0 : Disable Log.<br/> 1 : Enable Log.</p>                                                                                                                                                                                                                                                                                                                                                |

|                          |                                                                                                                                                                                                                                                                                                                                                                                                                                               |
|--------------------------|-----------------------------------------------------------------------------------------------------------------------------------------------------------------------------------------------------------------------------------------------------------------------------------------------------------------------------------------------------------------------------------------------------------------------------------------------|
| -m "<Param 0> <Param 1>" | <p>It means to set MAC Bind IP type and the Syslog.</p> <p>&lt;param 0&gt;: Enter the number to choose the type.</p> <p>0 : Non-Strict.<br/>1 : Strict.</p> <p>&lt;Param 1&gt;: Let the log be recorded on Syslog.</p> <p>0 : Disable Log.<br/>1 : Enable Log.</p>                                                                                                                                                                            |
| -Y <Param 0> <Param 1>   | <p>It means to set the User Management.</p> <p>&lt;param 0&gt;: Enter the number to choose the type.</p> <p>-1 : None.<br/>0 : All.<br/>1 : User Object<br/>2 : User group</p> <p>&lt;Param 1&gt;: Let the log be recorded on Syslog if &lt;param 0&gt; is set with None/ALL.</p> <p>0 : Disable.<br/>1 : Enable.</p> <p>Enter the the user object number (1 to 200) / group number (1 to 32) if &lt;param 0&gt; is set with User Object.</p> |
| -y <value>               | <p>It means the log related to User Management will be or be not recorded on Syslog.</p> <p>&lt;value&gt;: Enter 1(enable) or 0 (disable)</p>                                                                                                                                                                                                                                                                                                 |
| -L <Param 0> <Param 1>   | <p>It means to set the maximum count for the session limitation.</p> <p>&lt;param 0&gt;: Enter the number (0 to 60000) to choose the type.</p> <p>&lt;Param 1&gt;: Let the log be recorded on Syslog.</p> <p>0 : Disable.<br/>1 : Enable.</p>                                                                                                                                                                                                 |
| -q <Param 0> <Param 1>   | <p>It means to set the classification for QoS.</p> <p>&lt;Param 0&gt;:</p> <p>1- Class 1,<br/>2 - Class 2,<br/>3 - Class 3,<br/>4 - Other</p> <p>&lt;Param 1&gt;: Let the log be recorded on Syslog.</p> <p>0 : Disable.<br/>1 : Enable.</p>                                                                                                                                                                                                  |
| -A "<Param 0>"           | <p>It means to enable or disable the packet capture function.</p> <p>&lt;Param 0&gt;: Enter 0 or 1.</p> <p>0 : Disable.<br/>1 : Enable.</p>                                                                                                                                                                                                                                                                                                   |
| -I <Param 0> <Param 1>   | <p>It means load balance policy.</p> <p>Such function is used for "debug" only.</p> <p>&lt;Param 0&gt;: Enter 0, 1, 2, or 3.</p> <p>0:Auto-Select,<br/>1:WAN 1.<br/>2:WAN 2.<br/>3:WAN 3.</p> <p>&lt;Param 1&gt;: Enter 0 or 1.</p> <p>0:Disable Log.<br/>1:Enable Log.</p>                                                                                                                                                                   |
| -a "<Param 0> <Param 1>" | <p>It means to specify which APP Enforcement profile will be applied.</p>                                                                                                                                                                                                                                                                                                                                                                     |

|                                             |                                                                                                                                                                                                                                                                                                                                                                                                                                                                                                                                                                                                                                                                                                                                                                                               |
|---------------------------------------------|-----------------------------------------------------------------------------------------------------------------------------------------------------------------------------------------------------------------------------------------------------------------------------------------------------------------------------------------------------------------------------------------------------------------------------------------------------------------------------------------------------------------------------------------------------------------------------------------------------------------------------------------------------------------------------------------------------------------------------------------------------------------------------------------------|
|                                             | <p>&lt;Param 0&gt; : Available settings range from 0 - 32. "0" means no profile will be applied.</p> <p>&lt;Param 1&gt; : Let the log be recorded on Syslog.</p> <p>0 : Disable.</p> <p>1 : Enable.</p>                                                                                                                                                                                                                                                                                                                                                                                                                                                                                                                                                                                       |
| <i>-u &lt;Param 0&gt; &lt;Param 1&gt;</i>   | <p>It means to specify which URL Content Filter profile will be applied.</p> <p>&lt;Param 0&gt; : Available settings range from 0 - 8. "0" means no profile will be applied.</p> <p>&lt;Param 1&gt; : Let the log be recorded on Syslog.</p> <p>0 : Disable.</p> <p>1 : Enable.</p>                                                                                                                                                                                                                                                                                                                                                                                                                                                                                                           |
| <i>-w "&lt;Param 0&gt; &lt;Param 1&gt;"</i> | <p>It means to specify which Web Content Filter profile will be applied.</p> <p>&lt;Param 0&gt; : Available settings range from 0 - 8. "0" means no profile will be applied.</p> <p>&lt;Param 1&gt; : Let the log be recorded on Syslog.</p> <p>0 : Disable.</p> <p>1 : Enable.</p>                                                                                                                                                                                                                                                                                                                                                                                                                                                                                                           |
| <i>-n "&lt;Param 0&gt; &lt;Param 1&gt;"</i> | <p>It means to specify which DNS Filter profile will be applied.</p> <p>&lt;Param 0&gt; : Available settings range from 0 - 8. "0" means no profile will be applied.</p> <p>&lt;Param 1&gt; : Let the log be recorded on Syslog.</p> <p>0 : Disable.</p> <p>1 : Enable.</p>                                                                                                                                                                                                                                                                                                                                                                                                                                                                                                                   |
| <i>-N &lt;value&gt;</i>                     | <p>It means to set the Next Filter Set.</p> <p>&lt;value&gt; : Available settings range from 0 - 12. "0" means no profile will be applied.</p> <p>0 : None</p> <p>1 : Set#1; 2: Set#2, and so on.</p>                                                                                                                                                                                                                                                                                                                                                                                                                                                                                                                                                                                         |
| <i>-c &lt;0-20&gt;</i>                      | <p>It means to set code page. Different number represents different code page.</p> <p>0. None</p> <p>1. ANSI(1250)-Central Europe</p> <p>2. ANSI(1251)-Cyrillic</p> <p>3. ANSI(1252)-Latin I</p> <p>4. ANSI(1253)-Greek</p> <p>5. ANSI(1254)-Turkish</p> <p>6. ANSI(1255)-Hebrew</p> <p>7. ANSI(1256)-Arabic</p> <p>8. ANSI(1257)-Baltic</p> <p>9. ANSI(1258)-Viet Nam</p> <p>10. OEM(437)-United States</p> <p>11. OEM(850)-Multilingual Latin I</p> <p>12. OEM(860)-Portuguese</p> <p>13. OEM(861)-Icelandic</p> <p>14. OEM(863)-Canadian French</p> <p>15. OEM(865)-Nordic</p> <p>16. ANSI/OEM(874)-Thai</p> <p>17. ANSI/OEM(932)-Japanese Shift-JIS</p> <p>18. ANSI/OEM(936)-Simplified Chinese GBK</p> <p>19. ANSI/OEM(949)-Korean</p> <p>20. ANSI/OEM(950)-Traditional Chinese Big5</p> |
| <i>-C "&lt;Windows Size&gt;</i>             | <p>It means to set Window size and Session timeout (Minute).</p>                                                                                                                                                                                                                                                                                                                                                                                                                                                                                                                                                                                                                                                                                                                              |

|                                                     |                                                                                                                                                                                                                                                                                                                                                                                                                                                             |
|-----------------------------------------------------|-------------------------------------------------------------------------------------------------------------------------------------------------------------------------------------------------------------------------------------------------------------------------------------------------------------------------------------------------------------------------------------------------------------------------------------------------------------|
| <code>&lt;Session_Timeout&gt;"</code>               | <p>&lt;Windows Size&gt; - Available settings range from 1 - 65535.<br/>         &lt;Session_Timeout&gt; - Make the best utilization of network resources.</p>                                                                                                                                                                                                                                                                                               |
| <code>-b &lt;value&gt;</code>                       | <p>It means to enable or disable the DrayTek Banner.<br/>         &lt;value&gt;: 0 : Disable; 1 : Enable.</p>                                                                                                                                                                                                                                                                                                                                               |
| <code>-t "i &lt;Param 0&gt; &lt;Param 1&gt;"</code> | <p>It means to set schedule profile. Totally, there are four sets of schedule profiles can be specified.<br/>         &lt;param 0&gt;: Enter the index number (1 to 4) for each set.<br/>         &lt;param 1&gt;: Enter the index number (0 to 15) of the schedule profile for each set. 0 means none.<br/>         For example, -t "i 1 3" means schedule profile #3 is configured for set #1.<br/>         Exampe: &gt; ipf rule 3 1 -e 1 -t "i 1 3"</p> |
| <code>-t "c &lt;value&gt;"</code>                   | <p>It means to enable or disable the function of clearing sessions when the schedule is ON.<br/>         &lt;value&gt;: 0 : Disable; 1 : Enable.</p>                                                                                                                                                                                                                                                                                                        |
| <code>-M &lt;Your Comments&gt;</code>               | <p>It means to set comments for the filter rule.<br/>         &lt;Your Comments&gt;: Enter a brief description.</p>                                                                                                                                                                                                                                                                                                                                         |
| <code>-U "&lt;up/down&gt;"</code>                   | <p>It means to move up or move down the order of a filter rule in the filter set.<br/>         up: It indicates move the filter rule up.<br/>         down: It indicates move the filter rule down.</p>                                                                                                                                                                                                                                                     |

## Example

```

> ipf rule 2 1 -v
Filter Set 2 Rule 1:

Status      : Disable
Comments: <null>
Index(1-15) in Schedule Setup: <null>, <null>, <null>, <null>

Clear sessions when schedule is ON: Disable

Direction   : LAN/DMZ/RT/VPN -> WAN
Src Interface : LAN1, LAN2, LAN3, LAN4, LAN5, LAN6, LAN7, LAN8, DMZ, Routed,
VPN

Dst Interface : WAN1, WAN2, WAN3, WAN4, WAN5, WAN6, WAN7, WAN8, WAN9
Source IP     : Any
Destination IP: Any
Service Type  : Any
Fragments    : Don't Care

Pass or Block      : Pass Immediately
Branch to Other Filter Set: None
Max Sessions Limit : 60000
Current Sessions   : 0
Mac Bind IP       : Non-Strict
Qos Class         : None
Packet Capture    : Disable
APP Enforcement    : None
URL Content Filter : None
WEB Content Filter : None
DNS Filter        : None
Load-Balance policy : Auto-select

```

```

Log                : Disable
-----
CodePage           : ANSI(1252)-Latin I
Window size       : 65535
Session timeout   : 60
DrayTek Banner    : Enable
-----
Strict Security Checking
  [ ]APP Enforcement
>

```

## Telnet Command: ipf flowtrack

This command is used to set and view flowtrack sessions.

### Syntax

ipf flowtrack set <-r/-e>

ipf flowtrack view <-f/-b>

### Syntax Description

| Parameter | Description                                                                                                                                        |
|-----------|----------------------------------------------------------------------------------------------------------------------------------------------------|
| -r        | It means to refresh the flowtrack.                                                                                                                 |
| -e        | It means to enable or disable the flowtrack.                                                                                                       |
| -f        | It means to show the sessions state of flowtrack. If you do not specify any IP address, then all the session state of flowtrack will be displayed. |
| -b        | It means to show all of IPv6 sessions state.                                                                                                       |

### Example

```

> ipf flowtrack set -r
Refresh the flowstate ok
> ipf flowtrack view -f
Start to show the flowtrack sessions state:

ORIGIN>> 192.168.1.11:59939 ->      8.8.8.8: 53 ,ifno=0
REPLY >>      8.8.8.8: 53 -> 192.168.1.11:59939 ,ifno=3
          proto=17, age=93023180(3920), flag=203
ORIGIN>> 192.168.1.11:15073 ->     8.8.8.8: 53 ,ifno=0
REPLY >>      8.8.8.8: 53 -> 192.168.1.11:15073 ,ifno=3
          proto=17, age=93025100(2000), flag=203
ORIGIN>> 192.168.1.11: 7247 ->     8.8.8.8: 53 ,ifno=0
REPLY >>      8.8.8.8: 53 -> 192.168.1.11: 7247 ,ifno=3
          proto=17, age=93020100(7000), flag=203
End to show the flowtrack sessions state
> ipf flowtrack set -e
Current flow_enable=0
> ipf flowtrack set -e
Current flow_enable=1
>

```

## Telnet Command: Log

This command allows users to view log for WAN interface such as call log, IP filter log, flush log buffer, etc.

### Syntax

log [-cfhiptwx?] [-F a | c | f | w]

### Syntax Description

| Parameter | Description                                                                                                                                |
|-----------|--------------------------------------------------------------------------------------------------------------------------------------------|
| -c        | It means to show the latest call log.                                                                                                      |
| -f        | It means to show the IP filter log.                                                                                                        |
| -F        | It means to show the flush log buffer.<br>a: flush all logs<br>c: flush the call log<br>f: flush the IP filter log<br>w: flush the WAN log |
| -h        | It means to show this usage help.                                                                                                          |
| -p        | It means to show PPP/MP log.                                                                                                               |
| -t        | It means to show all logs saved in the log buffer.                                                                                         |
| -w        | It means to show WAN log.                                                                                                                  |
| -x        | It means to show packet body hex dump.                                                                                                     |

### Example

```
> log -w
25:36:25.580 ---->DHCP (WAN-5) Len = 548XID = 0x7880fdd4
    Client IP      = 0.0.0.0
    Your IP       = 0.0.0.0
    Next server IP = 0.0.0.0
    Relay agent IP = 0.0.0.0
25:36:33.580 ---->DHCP (WAN-5) Len = 548XID = 0x7880fdd4
    Client IP      = 0.0.0.0
    Your IP       = 0.0.0.0
    Next server IP = 0.0.0.0
    Relay agent IP = 0.0.0.0
25:36:41.580 ---->DHCP (WAN-5) Len = 548XID = 0x7880fdd4
    Client IP      = 0.0.0.0
    Your IP       = 0.0.0.0
    Next server IP = 0.0.0.0
    Relay agent IP = 0.0.0.0
25:36:49.580 ---->DHCP (WAN-5) Len = 548XID = 0x7880fdd4
    Client IP      = 0.0.0.0
    Your IP       = 0.0.0.0
    Next server IP = 0.0.0.0
    Relay agent IP = 0.0.0.0
25:36:57.580 ---->DHCP (WAN-5) Len = 548XID = 0x7880fdd4
    Client IP      = 0.0.0.0
    Your IP       = 0.0.0.0
--- MORE ---  ['q': Quit, 'Enter': New Lines, 'Space Bar': Next Page] ---
```

## Telnet Command: ldap user

This command is used to configure the LDAP profile.

### Syntax

ldap user <INDEX><OPTION>

### Syntax Description

| Parameter       | Description                                            |
|-----------------|--------------------------------------------------------|
| <i>INDEX</i>    | Specify the index number (1 to 8) of the LDAP profile. |
| <i>OPTION</i>   |                                                        |
| <i>-n VALUE</i> | Setup Profile Name.                                    |
| <i>-b VALUE</i> | Setup Base Distinguished Name.                         |
| <i>-a VALUE</i> | Setup Additional Filter.                               |
| <i>-g VALUE</i> | Setup Group Distinguished Name.                        |
| <i>-c VALUE</i> | Setup Common Name Identifier.                          |
| <i>-v</i>       | View detail information of the LDAP profile.           |

### Example

```
> ldap user 1 -n LD_user_test1
Profile Name has been updated!
> ldap user 1 -v
Profile Index:1
Profile Name:LD_user_test1
Common Name Identifier:
Base Distinguished Name:
Additional Filter:
Group distinguished Name:
>
```

## Telnet Command: ldap set

This command is used to set general settings (e.g., IP address, port number) for LDAP server.

### Syntax

ldap set <Options><Value>

### Syntax Description

| Parameter                 | Description                                                                                              |
|---------------------------|----------------------------------------------------------------------------------------------------------|
| <i>enable &lt;0-1&gt;</i> | Enable or disable LDAP function.<br>0 : Disable the function.<br>1 : Enable the function.                |
| <i>type &lt;0-2&gt;</i>   | Set the bind type as Simple(0),Anonymous(1), and Regular(2).                                             |
| <i>ssl &lt;0-1&gt;</i>    | Enable or disable LDAP function via SSL tunnel.<br>0 : Disable the function.<br>1 : Enable the function. |
| <i>IP &lt;VALUE&gt;</i>   | Set IP address for LDAP server.                                                                          |
| <i>port &lt;VALUE&gt;</i> | Set port number for LDAP server.                                                                         |



|                    |                             |
|--------------------|-----------------------------|
| <i>dn</i> <VALUE>  | Set Regular DN value        |
| <i>PWD</i> <VALUE> | Set Regular password value. |

### Example

```

> ldap set enable 1
LDAP enabled!
> ldap enabled.
> ldap set ssl 1
LDAP with SSL has been enabled!
> ldap set IP 192.168.100.155
LDAP Server IP has been setting.
> ldap set port 389
LDAP Server Port has been setting.
> ldap set dn dc=example,dc=com
LDAP Regular DN has been setting.
> ldap set PWD 123456
LDAP Regular Password has been setting.

```

## Telnet Command: ldap view

This command is used to check current status of LDAP settings configuration.

### Syntax

ldap view

### Example

```

> ldap view ?
LDAP Enable:Disabled.
LDAP Bind Type:Simple
LDAP with SSL:Disabled
LDAP Regular DN:
LDAP Regular Password:
LDAP Server IP:
LDAP Server Port:389
>

```

## Telnet Command: tacacsplus set

This command allows users to configure general settings for TACACS+ server.

### Syntax

tacacsplus set <Options><Value>

### Syntax Description

| Parameter                    | Description                                    |
|------------------------------|------------------------------------------------|
| <i>enable</i> <0/1>          | Disable (0)/enable(1) the TACACS+ server.      |
| <i>IP</i> <VALUE>            | Set the IP address of TACACS+ server.          |
| <i>port</i> <VALUE>          | Set the port number of TACACS+ server.         |
| <i>shared_secret</i> <VALUE> | Set the Shared Secret value of TACACS+ Server. |

### Example

```

> tacacsplus set enable 1
TACACS+ enabled!
This setting will take effect after rebooting.
Please use "sys reboot" command to reboot the router.

> tacacsplus set IP 192.168.1.59
TACACS+ Server IP has been setting.
This setting will take effect after rebooting.
Please use "sys reboot" command to reboot the router.

> tacacsplus view
TACACS+ Enable:Enable.
TACACS+ Server IP:192.168.1.59
TACACS+ Server Port:49
TACACS+ Type:ASCII
TACACS+ Shared Secret:
>

```

## Telnet Command: tacacsplus view

This command allows users to check the general settings for TACACS+ server

### Syntax

tacacspluse view

### Example

```

> tacacsplus view
TACACS+ Enable:Enable.
TACACS+ Server IP:192.168.1.59
TACACS+ Server Port:49
TACACS+ Type:ASCII
TACACS+ Shared Secret:

```

## Telnet Command: mngt ftpport

This command allows users to set FTP port for management.

### Syntax

mngt ftpport <FTP port>

### Syntax Description

| Parameter       | Description                                                           |
|-----------------|-----------------------------------------------------------------------|
| <i>FTP port</i> | It means to Enter the number for FTP port. The default setting is 21. |

### Example

```

> mngt ftpport 21
% Set FTP server port to 21 done.

```

## Telnet Command: mngt httpport

This command allows users to set HTTP port for management.

### Syntax

mngt httpport <Http port>

### Syntax Description

| Parameter        | Description                                                            |
|------------------|------------------------------------------------------------------------|
| <i>Http port</i> | It means to enter the number for HTTP port. The default setting is 80. |

### Example

```
> mngt httpport 80
% Set web server port to 80 done.
```

## Telnet Command: mngt httpsport

This command allows users to set HTTPS port for management.

### Syntax

mngt httpsport <Https port>

### Syntax Description

| Parameter         | Description                                                              |
|-------------------|--------------------------------------------------------------------------|
| <i>Https port</i> | It means to Enter the number for HTTPS port. The default setting is 443. |

### Example

```
> mngt httpsport 443
% Set web server port to 443 done.
```

## Telnet Command: mngt sslvpnport

This command allows users to set SSL VPN port for management.

### Syntax

mngt sslvpnport <SSL VPN port>

### Syntax Description

| Parameter           | Description                                                               |
|---------------------|---------------------------------------------------------------------------|
| <i>SSL VPN port</i> | It means to type the number for SSL VPN port. The default setting is 443. |

### Example

```
> mngt sslvpnport 1010
% Set SSL VPN port to 1010 done.
```

## Telnet Command: mngt telnetport

This command allows users to set telnet port for management.

### Syntax

mngt telnetport <Telnet port>

### Syntax Description

| Parameter          | Description                                                              |
|--------------------|--------------------------------------------------------------------------|
| <i>Telnet port</i> | It means to Enter the number for telnet port. The default setting is 23. |

### Example

```
> mngt telnetport 23
% Set Telnet server port to 23 done.
```

## Telnet Command: mngt sshport

This command allows users to set SSH port for management.

### Syntax

mngt sshport <*ssh port*>

### Syntax Description

| Parameter       | Description                                                           |
|-----------------|-----------------------------------------------------------------------|
| <i>ssh port</i> | It means to Enter the number for SSH port. The default setting is 22. |

### Example

```
> mngt sshport 23
% Set ssh port to 23 done.
```

## Telnet Command: mngt noping

This command is used to pass or block Ping from LAN PC to the internet.

### Syntax

mngt noping *on*  
mngt noping *off*  
mngt noping *viewlog*  
mngt noping *clearlog*

### Syntax Description

| Parameter       | Description                                                                   |
|-----------------|-------------------------------------------------------------------------------|
| <i>on</i>       | All PING packets will be forwarded from LAN PC to Internet.                   |
| <i>off</i>      | All PING packets will be blocked from LAN PC to Internet.                     |
| <i>viewlog</i>  | It means to display a log of ping action, including source MAC and source IP. |
| <i>clearlog</i> | It means to clear the log of ping action.                                     |

### Example

```
> mngt noping off
No Ping Packet Out is OFF!!
```

## Telnet Command: mngt defenseworm

This command can block specified port for passing through the router.

## Syntax

```
mngt defenseworm on
mngt defenseworm off
mngt defenseworm <add port>
mngt defenseworm <del port>
mngt defenseworm <viewlog>
mngt defenseworm <clearlog>
```

## Syntax Description

| Parameter       | Description                                                                           |
|-----------------|---------------------------------------------------------------------------------------|
| <i>on</i>       | It means to activate the function of defense worm packet out.                         |
| <i>off</i>      | It means to inactivate the function of defense worm packet out.                       |
| <i>add port</i> | It means to add a new TCP port for block.                                             |
| <i>del port</i> | It means to delete a TCP port for block.                                              |
| <i>viewlog</i>  | It means to display a log of defense worm packet, including source MAC and source IP. |
| <i>clearlog</i> | It means to remove the log of defense worm packet.                                    |

## Example

```
> mngt defenseworm add 21
Add TCP port 21
Block TCP port list: 135, 137, 138, 139, 445, 21
> mngt defenseworm del 21
Delete TCP port 21
Block TCP port list: 135, 137, 138, 139, 445
```

## Telnet Command: mngt rmtcfg

This command can allow the system administrators to login from the Internet. By default, it is not allowed.

## Syntax

```
mngt rmtcfg <status>
mngt rmtcfg <enable>
mngt rmtcfg <disable>
mngt rmtcfg <http/https/ftp/telnet/ssh/tr069/snmp/enforce_https> <on/off>
```

## Syntax Description

| Parameter                                                 | Description                                                                 |
|-----------------------------------------------------------|-----------------------------------------------------------------------------|
| <i>status</i>                                             | It means to display current setting for your reference.                     |
| <i>enable</i>                                             | It means to allow the system administrators to login from the Internet.     |
| <i>disable</i>                                            | It means to deny the system administrators to login from the Internet.      |
| <i>http/https/ftp/telnet/ssh/tr069/snmp/enforce_https</i> | It means to specify one of the servers/protocols for enabling or disabling. |
| <i>on/off</i>                                             | on - enable the function.                                                   |

---

|                             |
|-----------------------------|
| off - disable the function. |
|-----------------------------|

---

## Example

```
> mngt rmtcfg ftp on
Enable server fail
Remote configure function has been disabled
please enable by enter mngt rmtcfg enable

> mngt rmtcfg enable
%% Remote configure function has been enabled.
> mngt rmtcfg ftp on
%% FTP server has been enabled.
```

## Telnet Command: mngt lanaccess

This command allows users to manage accessing into Vigor router through LAN port.

### Syntax

mngt lanaccess *-e* <0/1> *-s* <value> *-i* <value>

mngt lanaccess *-l*

mngt lanaccess *-E*

mngt lanaccess *-f*

mngt lanaccess *-d*

mngt lanaccess *-v*

mngt lanaccess *-h*

### Syntax Description

| Parameter         | Description                                                                                                                                                                                    |
|-------------------|------------------------------------------------------------------------------------------------------------------------------------------------------------------------------------------------|
| <i>-e</i> <0/1>   | It means to enable/disable the function.<br>0-disable the function.<br>1-enable the function.                                                                                                  |
| <i>-s</i> <value> | It means to specify service offered.<br>Available values include:<br>FTP, HTTP, HTTPS, ENFORCE_HTTPS, TELNET, SSH, None, All                                                                   |
| <i>-i</i> <value> | It means the interface which is allowed to access.<br>Available values include:<br>LAN2-LAN16, DMZ, IP Routed Subnet, None, All<br>Note: LAN1 is always allowed for accessing into the router. |
| <i>-l</i> <value> | It means the IP object index allowed to access.<br>Available values include: 1 to 192.                                                                                                         |
| <i>-E</i> <0/1>   | It means to enable the function of specific IP allowed to be access.<br>0-disable the function.<br>1-enable the function.                                                                      |
| <i>-f</i>         | It means to flush all of the settings.                                                                                                                                                         |
| <i>-d</i>         | It means to restore the factory default settings.                                                                                                                                              |
| <i>-v</i>         | It means to view current settings.                                                                                                                                                             |
| <i>-h</i>         | It means to get the usage of such command.                                                                                                                                                     |

## Example

```
> mngt lanaccess -e 1
> mngt lanaccess -s FTP,TELNET
> mngt lanaccess -i LAN3
> mngt lanaccess -v
Current LAN Access Control Setting:
* Enable:Yes
  - FTP:Yes
  - HTTP:Yes
  - HTTPS:Yes
  - TELNET:Yes
  - SSH:Yes
  - TR069:Yes
  - Enforce HTTPS:No
Subnet:
  - LAN 1: enabled
    - Specific IP(type:IP Object)(index:0) is disabled
  - LAN 2: enabled
    - Specific IP(type:IP Object)(index:0) is disabled
  - LAN 3: enabled
    - Specific IP(type:IP Object)(index:0) is disabled
  - LAN 4: enabled
    - Specific IP(type:IP Object)(index:0) is disabled
  - LAN 5: enabled
    - Specific IP(type:IP Object)(index:0) is disabled
  - LAN 6: enabled
    - Specific IP(type:IP Object)(index:0) is disabled
  - LAN 7: enabled
    - Specific IP(type:IP Object)(index:0) is disabled
  - LAN 8: enabled
    - Specific IP(type:IP Object)(index:0) is disabled
  - LAN 9: enabled
    - Specific IP(type:IP Object)(index:0) is disabled
  - LAN 10: enabled
    - Specific IP(type:IP Object)(index:0) is disabled
  - LAN 11: enabled
    - Specific IP(type:IP Object)(index:0) is disabled
  - LAN 12: enabled
    - Specific IP(type:IP Object)(index:0) is disabled
  - LAN 13: enabled
    - Specific IP(type:IP Object)(index:0) is disabled
  - LAN 14: enabled
    - Specific IP(type:IP Object)(index:0) is disabled
  - LAN 15: enabled
    - Specific IP(type:IP Object)(index:0) is disabled
  - LAN 16: enabled
    - Specific IP(type:IP Object)(index:0) is disabled
  - DMZ: enabled
    - Specific IP(type:IP Object)(index:0) is disabled
  - IP Routed Subnet: enabled
    - Specific IP(type:IP Object)(index:0) is disabled
>
```

## Telnet Command: mngt echoicmp

This command allows users to reject or accept PING packets from the Internet.

### Syntax

mngt echoicmp <enable>

mngt echoicmp <disable>

### Syntax Description

| Parameter      | Description                              |
|----------------|------------------------------------------|
| <i>enable</i>  | It means to accept the echo ICMP packet. |
| <i>disable</i> | It means to drop the echo ICMP packet.   |

### Example

```
> mngt echoicmp enable
%% Echo ICMP packet enabled.
```

## Telnet Command: mngt accesslist

This command allows you to specify that the system administrator can login from a specific host or network. A maximum of ten IPs/subnet masks is allowed.

### Syntax

mngt accesslist *list*

mngt accesslist *add* <Index><IP Object Index>

mngt accesslist *remove* <Index>

mngt accesslist *flush*

### Syntax Description

| Parameter                | Description                                                                                                                                                                           |
|--------------------------|---------------------------------------------------------------------------------------------------------------------------------------------------------------------------------------|
| <i>list</i>              | It can display current setting for your reference.                                                                                                                                    |
| <i>add</i>               | It means adding a new entry.                                                                                                                                                          |
| <Index><IP Object Index> | It means to specify the IP object. Available settings:<br><index> - Enter the index number of the accesslist profile.<br><IP Object Index> - Enter the index number of the IP object. |
| <i>No.</i>               | A maximum of 10 IP objects are allowed to be assigned.                                                                                                                                |
| <i>index</i>             | It means the index number (1 to 192) of the IP objects preconfigured.                                                                                                                 |
| <i>remove</i>            | It means to delete the selected item.                                                                                                                                                 |
| <i>flush</i>             | It means to remove all the settings in the access list.                                                                                                                               |

### Example

```
> mngt accesslist add 1 1
%% Set OK.
> mngt accesslist list
%% Access list :
```



```

[Index]      [IP Object Index]      [IP/CIDR or StartIP ~ EndIP]
=====
1           1                      Please setting index=1 for IP Object
>

```

## Telnet Command: mngt wanlogin

This command allows you to enable or disable WAN login function.

### Syntax

mngt wanlogin *enable*

mngt wanlogin *disable*

### Example

```

> mngt wanlogin enable
%% wan login enabled.
>

```

## Telnet Command: mngt snmp

This command allows you to configure SNMP for management.

### Syntax

mngt snmp [-<command> <parameter> | ... ]

### Syntax Description

| Parameter                      | Description                                                                                                                                                            |
|--------------------------------|------------------------------------------------------------------------------------------------------------------------------------------------------------------------|
| [<command><br><parameter> ...] | The available commands with parameters are listed below.<br>[...] means that you can Enter several commands in one line.                                               |
| -e <1/2>                       | 1: Enable the SNMP function.<br>2: Disable the SNMP function.                                                                                                          |
| -a <1/2>                       | 1: Enable the SNMPV1 function.<br>2: Disable the SNMPV1 function.                                                                                                      |
| -b <1/2>                       | 1: Enable the SNMPV2C function.<br>2: Disable the SNMPV2C function.                                                                                                    |
| -c <1/2>                       | 1: Enable the SNMPV3 function.<br>2: Disable the SNMPV3 function.                                                                                                      |
| -g <Community name>            | It means to set the name for getting community by typing a proper character. (max. 23 characters)                                                                      |
| -s <Community name>            | It means to set community by typing a proper name. (max. 23 characters)                                                                                                |
| -m <IP address>                | It means to set one host as the manager to execute SNMP function.<br>Please type in IPv4 address to specify certain host.<br>It allows to set 3 IPs, separated by ",". |
| -t <Community name>            | It means to set trap community by typing a proper name. (max. 23 characters)                                                                                           |
| -n <IP address>                | It means to set the notification host.<br>It allows to set 2 IPs, separated by ",".                                                                                    |
| -T <seconds>                   | It means to set the trap timeout <0-999>.                                                                                                                              |

|                                  |                                                                                           |
|----------------------------------|-------------------------------------------------------------------------------------------|
| <code>-o &lt;username&gt;</code> | It means to set a user account (maximum 23 characters) for user management.               |
| <code>-p &lt;0/1/2&gt;</code>    | It means to set the authentication algorithm.<br>0: No auth<br>1: MD5_AUTH<br>2: SHA_AUTH |
| <code>-q &lt;password&gt;</code> | It means to set the password (maximum 23 characters) for authentication.                  |
| <code>-r &lt;0,3/4/6&gt;</code>  | It means to set privacy algorithm<br>0, 3: No_PRIV<br>4: DES_PRIV<br>6: AES_PRIV          |
| <code>-u &lt;password&gt;</code> | It means to set the password (maximum 23 characters) for privacy.                         |
| <code>-V</code>                  | It means to list SNMP setting.                                                            |

### Example

```
> mngt snmp -e 1 -g draytek -s DK -m
192.168.1.20,192.168.5.192/26,10.20.3.40/24 -t trapcom -n
192.168.1.20,10.20.3.40 -T 88
SNMP Agent Turn on!!!
Get Community set to draytek
Set Community set to DK
Manager Host IP set to 192.168.1.20,192.168.5.192/26,10.20.3.40/24
Trap Community set to trapcom
Notification Host IP set to 192.168.1.20,10.20.3.40
Trap Timeout set to 88 seconds
>
```

### Telnet Command: mngt bfp

This command allows you to configure brute force protect (BFP) for system management.

### Syntax

`mngt bfp [<command><parameter>|...]`

### Syntax Description

| Parameter                                                | Description                                                                                                                     |
|----------------------------------------------------------|---------------------------------------------------------------------------------------------------------------------------------|
| <code>[&lt;command&gt;<br/>&lt;parameter&gt; ...]</code> | The available commands with parameters are listed below.<br>[...] means that you can type in several commands in one line.      |
| <code>-e 0/1</code>                                      | Enable / disable the BFP function.<br>0 - Disable<br>1 - Enable                                                                 |
| <code>-s &lt;service&gt;</code>                          | It means to enable different service.<br>service - Available types are FTP, HTTP, HTTPS, TELNET, TR069, SSH, VPN, None and All. |
| <code>-l &lt;failure&gt;</code>                          | It means to set login failure retry times.<br>failure - Available number is from 1 to 255.                                      |
| <code>-p &lt;penalty&gt;</code>                          | It means to set penalty time for BFP. The unit is sec.                                                                          |
| <code>-u &lt;IP&gt;</code>                               | It means to unblock an IP address in list.                                                                                      |
| <code>-v</code>                                          | It means to view current settings.                                                                                              |

## Example

```
> mngt bfp -e 1
> mngt bfp -s FTP
> mngt bfp -l 10
> mngt bfp -v
Current Brute Force Protection Setting:
* Enable: yes
* Service:
  - FTP:      yes
  - HTTP:     no
  - HTTPS:    no
  - TELNET:   no
  - TR069:    no
  - SSH:      no
* Maximum login failures: 10
* Penalty period: 0
```

## Telnet Command: mngt cert\_import

This command allows you to import a certificate to Vigor router.

### Syntax

```
mngt cert_import local_cert <URL><password>
```

```
mngt cert_import trusted_ca <URL>
```

### Syntax Description

| Parameter                                                    | Description                                                                                                                                                                                        |
|--------------------------------------------------------------|----------------------------------------------------------------------------------------------------------------------------------------------------------------------------------------------------|
| <i>local_cert url &lt;URL&gt;</i><br><i>&lt;password&gt;</i> | URL - Enter a URL(http://....) for downloading the certificate.<br>The file is encrypted with the file format of "xxxx.p12".<br>Password - Enter the password for decrypting the .p12 certificate. |
| <i>trusted_ca &lt;URL&gt;</i>                                | URL - Enter a URL(http://....) for downloading the certificate.<br>The file is encrypted with the file format of "xxxx.p12".                                                                       |

## Telnet Command: mngt telnettimeout

This command allows you to configure the timeout for telnet connection.

### Syntax

```
mngt telnettimeout <value>
```

### Syntax Description

| Parameter            | Description                                               |
|----------------------|-----------------------------------------------------------|
| <i>&lt;value&gt;</i> | Range from 60 to 300. The default value is 300 (seconds). |

## Example

```
> mngt telnettimeout 100
% Telnet timeout : 100s
>
```

## Telnet Command: mngt ssttimeout

This command allows you to configure the timeout for SSH connection.

## Syntax

mngt ssttimeout <value>

## Syntax Description

| Parameter | Description                                               |
|-----------|-----------------------------------------------------------|
| <value>   | Range from 60 to 300. The default value is 180 (seconds). |

## Example

```
> mngt ssttimeout 200
% SSH timeout : 200s
>
```

## Telnet Command: mngt ip6\_IIDs

This command allows you to configure the IPv6 interface ID.

## Syntax

mngt ip6-IIDs -e <val>>

mngt ip6\_IIDs -r <interface>

mngt ip6\_IIDs -s

## Syntax Description

| Parameter      | Description                                                                                                                                                |
|----------------|------------------------------------------------------------------------------------------------------------------------------------------------------------|
| -e <value>     | It is used to determine the way of generating IPv6 interface id.<br>val = 0 : Use EUI-64 IIDs as interface id<br>val = 1 : Use Random IIDs as interface id |
| -r <interface> | It is used to re-generate the random IIDs of the specified interface.<br>interface = LAN1/LAN2/.../WAN1/WAN2/USB1/USB2...                                  |
| -s             | Displays the random IIDs for each interface.                                                                                                               |

## Example

```
> mngt ip6_IIDs -e 1
% Setting success, the change will take effect after router rebooting.
> mngt ip6_IIDs -r LAN1
% Setting success, the change will take effect after router rebooting.
> mngt ip6_IIDs -s
% LAN IIDs = 9a5d:06c3:c972:f3ad
% WAN1 IIDs = 7651:92cc:6f8b:42c8
% WAN2 IIDs = 79e5:56cd:be43:384a
% WAN3 IIDs = 0193:56a8:5c6e:01e7
% WAN4 IIDs = 47bf:a971:857d:5a07
% LTE IIDs = e4bf:d21d:f59f:888d
% USB IIDs = 4c55:260c:e5f5:57b7
>
```

## Telnet Command: msubnet switch

This command is used to configure multi-subnet.

## Syntax

`msubnet switch <2/3/4/5/6/7/8/dmz><On/Off>`

## Syntax Description

| Parameter                | Description                                                                                              |
|--------------------------|----------------------------------------------------------------------------------------------------------|
| <i>2/3/4/5/6/7/8/dmz</i> | It means LAN interface.<br>2=LAN2<br>3=LAN3<br>4=LAN4<br>5=LAN5<br>6=LAN6<br>7=LAN7<br>8=LAN8<br>dmz=DMZ |
| <i>On/Off</i>            | On means turning on the subnet for the specified LAN interface.<br>Off means turning off the subnet.     |

## Example

```
> ms subnet switch 2 On
% LAN2      Subnet On!
```

This setting will take effect after rebooting.  
Please use "sys reboot" command to reboot the router.

## Telnet Command: ms subnet addr

This command is used to configure IP address for the specified LAN interface.

## Syntax

`msubnet addr <2/3/4/5/6/7/8/dmz><IP address>`

## Syntax Description

| Parameter                | Description                                                                                              |
|--------------------------|----------------------------------------------------------------------------------------------------------|
| <i>2/3/4/5/6/7/8/dmz</i> | It means LAN interface.<br>2=LAN2<br>3=LAN3<br>4=LAN4<br>5=LAN5<br>6=LAN6<br>7=LAN7<br>8=LAN8<br>dmz=DMZ |
| <i>IP address</i>        | Enter the private IP address for the specified LAN interface.                                            |

## Example

```
> ms subnet addr 2 192.168.5.1
```

```
% Set LAN2 subnet IP address done !!!
```

```
This setting will take effect after rebooting.  
Please use "sys reboot" command to reboot the router.
```

## Telnet Command: msubnet nmask

This command is used to configure net mask address for the specified LAN interface.

### Syntax

```
msubnet nmask <2/3/4/5/6/7/8/dmz><IP address>
```

### Syntax Description

| Parameter                | Description                                                                                              |
|--------------------------|----------------------------------------------------------------------------------------------------------|
| <i>2/3/4/5/6/7/8/dmz</i> | It means LAN interface.<br>2=LAN2<br>3=LAN3<br>4=LAN4<br>5=LAN5<br>6=LAN6<br>7=LAN7<br>8=LAN8<br>dmz=DMZ |
| <i>IP address</i>        | Enter the subnet mask address for the specified LAN interface.                                           |

### Example

```
> msubnet nmask 2 255.255.0.0
```

```
% Set LAN2 subnet mask done !!!
```

```
This setting will take effect after rebooting.  
Please use "sys reboot" command to reboot the router.
```

## Telnet Command: msubnet status

This command is used to display current status of subnet.

### Syntax

```
msubnet status <2/3/4/5/6/7/8/dmz>
```

### Syntax Description

| Parameter                | Description                                                                                   |
|--------------------------|-----------------------------------------------------------------------------------------------|
| <i>2/3/4/5/6/7/8/dmz</i> | It means LAN interface.<br>2=LAN2<br>3=LAN3<br>4=LAN4<br>5=LAN5<br>6=LAN6<br>7=LAN7<br>8=LAN8 |

---

---

dmz=DMZ

---

---

## Example

```
> msubnet status 2
% LAN2      Off: 0.0.0.0/0.0.0.0, PPP Start IP: 0.0.0.60
% DHCP server: Off
% Dhcp Gateway: 0.0.0.0, Start IP: 0.0.0.10, Pool Count: 50
```

## Telnet Command: msubnet dhcps

This command allows you to enable or disable DHCP server for the subnet.

### Syntax

msubnet dhcps <2/3/4/5/6/7/8/dmz><On/Off>

### Syntax Description

| Parameter                | Description                                                                                                |
|--------------------------|------------------------------------------------------------------------------------------------------------|
| <i>2/3/4/5/6/7/8/dmz</i> | It means LAN interface.<br>2=LAN2<br>3=LAN3<br>4=LAN4<br>5=LAN5<br>6=LAN6<br>7=LAN7<br>8=LAN8<br>dmz=DMZ   |
| <i>On/Off</i>            | On means enabling the DHCP server for the specified LAN interface.<br>Off means disabling the DHCP server. |

## Example

```
> msubnet dhcps 3 off
% LAN3      Subnet DHCP Server disabled!

This setting will take effect after rebooting.
Please use "sys reboot" command to reboot the router.
```

## Telnet Command: msubnet nat

This command is used to configure the subnet for NAT or Routing usage.

### Syntax

msubnet nat <2/3/4/5/6/7/8/dmz><On/Off>

### Syntax Description

| Parameter                | Description                                                                         |
|--------------------------|-------------------------------------------------------------------------------------|
| <i>2/3/4/5/6/7/8/dmz</i> | It means LAN interface.<br>2=LAN2<br>3=LAN3<br>4=LAN4<br>5=LAN5<br>6=LAN6<br>7=LAN7 |

|               |                                                                                                                               |
|---------------|-------------------------------------------------------------------------------------------------------------------------------|
|               | 8=LAN8<br>dmz=DMZ                                                                                                             |
| <i>On/Off</i> | On - It means the subnet will be configured for NAT usage.<br>Off - It means the subnet will be configured for Routing usage. |

### Example

```
> msubnet nat 2 off
% LAN2 Subnet is for Routing usage!
% LAN2 Subnet is for Routing usage!
%Note: If you have multiple WAN connections, please be reminded to setup a
Load-Balance policy so that packets from this subnet will be forwarded to the
right WAN interface!

This setting will take effect after rebooting.
Please use "sys reboot" command to reboot the router.
```

### Telnet Command: msubnet gateway

This command is used to configure an IP address as the gateway used for subnet.

#### Syntax

msubnet gateway <2/3/4/5/6/7/8/dmz><Gateway IP>

#### Syntax Description

| Parameter                | Description                                                                                              |
|--------------------------|----------------------------------------------------------------------------------------------------------|
| <i>2/3/4/5/6/7/8/dmz</i> | It means LAN interface.<br>2=LAN2<br>3=LAN3<br>4=LAN4<br>5=LAN5<br>6=LAN6<br>7=LAN7<br>8=LAN8<br>dmz=DMZ |
| <i>Gateway IP</i>        | Specify an IP address as the gateway IP.                                                                 |

### Example

```
> msubnet gateway 2 192.168.1.13
% Set LAN2 Dhcp Gateway IP done !!!

This setting will take effect after rebooting.
Please use "sys reboot" command to reboot the router.
```

### Telnet Command: msubnet ipcnt

This command is used to defined the total number allowed for each LAN interface.

#### Syntax

msubnet ipcnt <2/3/4/5/6/7/8/dmz> <IP counts>

#### Syntax Description

| Parameter                | Description                       |
|--------------------------|-----------------------------------|
| <i>2/3/4/5/6/7/8/dmz</i> | It means LAN interface.<br>2=LAN2 |



|                  |                                                                                                               |
|------------------|---------------------------------------------------------------------------------------------------------------|
|                  | 3=LAN3<br>4=LAN4<br>5=LAN5<br>6=LAN6<br>7=LAN7<br>8=LAN8<br>dmz=DMZ                                           |
| <i>IP counts</i> | Specify a total number of IP address allowed for each LAN interface.<br>The available range is from 0 to 220. |

### Example

```
> msubnet ipcnt 2 15
This setting will take effect after rebooting.
Please use "sys reboot" command to reboot the router.
```

### Telnet Command: msubnet talk

This command is used to establish a route between two LAN interfaces.

### Syntax

`msubnet talk <1/2/3/4/5/6/7/8/dmz> <1/2/3/4/5/6/7/8/dmz> <On/Off>`

### Syntax Description

| Parameter                  | Description                                                                                                        |
|----------------------------|--------------------------------------------------------------------------------------------------------------------|
| <i>1/2/3/4/5/6/7/8/dmz</i> | It means LAN interface.<br>1=LAN1<br>2=LAN2<br>3=LAN3<br>4=LAN4<br>5=LAN5<br>6=LAN6<br>7=LAN7<br>8=LAN8<br>dmz=DMZ |
| <i>On/Off</i>              | On - It means to enable the function.<br>Off - It means to disable the function.                                   |

### Example

```
> msubnet talk 1 2 on
% Enable routing between LAN1          and LAN2          !

This setting will take effect after rebooting.
Please use "sys reboot" command to reboot the router.
> msubnet talk ?
% msubnet talk <1/2/3/4/5/6/7/8/dmz> <1/2/3/4/5/6/7/8/dmz> <On/Off>
% where 1:LAN1, 2:LAN2, 3:LAN3, 4:LAN4, 5:LAN5, 6:LAN6, 7:LAN7, 8:LAN8, dmz:DMZ
Port
% Now:
%          LAN1  LAN2  LAN3  LAN4  LAN5  LAN6  LAN7  LAN8  DMZ Port
% LAN1          V
% LAN2          V  V
```

```

% LAN3          V
% LAN4          V
% LAN5          V
% LAN6          V
% LAN7          V
% LAN8          V
% DMZ Port      V
>

```

## Telnet Command: msubnet startip

This command is used to configure a starting IP address for DHCP.

### Syntax

`msubnet startip <2/3/4/5/6/7/8/dmz><Gateway IP>`

### Syntax Description

| Parameter                | Description                                                                                              |
|--------------------------|----------------------------------------------------------------------------------------------------------|
| <i>2/3/4/5/6/7/8/dmz</i> | It means LAN interface.<br>2=LAN2<br>3=LAN3<br>4=LAN4<br>5=LAN5<br>6=LAN6<br>7=LAN7<br>8=LAN8<br>dmz=DMZ |
| <i>Gateway IP</i>        | Type an IP address as the starting IP address for a subnet.                                              |

### Example

```

> msubnet startip 2 192.168.2.90
%Set LAN2 Dhcp Start IP done !!!

This setting will take effect after rebooting.
Please use "sys reboot" command to reboot the router.
> msubnet startip ?
% msubnet startip <2/3/4/5/6/7/8/dmz> <Gateway IP>
% Now: LAN2 192.168.2.90; LAN3 192.168.3.10; LAN4 192.168.4.10; LAN5
192.168.5.10; LAN6 192.168.6.10; LAN7 192.168.7.10; LAN8 192.168.8.10
>

```

## Telnet Command: msubnet pppip

This command is used to configure a starting IP address for PPP connection.

### Syntax

`msubnet pppip <2/3/4/5/6/7/8/dmz><Start IP>`

### Syntax Description

| Parameter                | Description                       |
|--------------------------|-----------------------------------|
| <i>2/3/4/5/6/7/8/dmz</i> | It means LAN interface.<br>2=LAN2 |

|                 |                                                                     |
|-----------------|---------------------------------------------------------------------|
|                 | 3=LAN3<br>4=LAN4<br>5=LAN5<br>6=LAN6<br>7=LAN7<br>8=LAN8<br>dmz=DMZ |
| <i>Start IP</i> | Type an IP address as the starting IP address for PPP connection.   |

### Example

```
> msubnet pppip 2 192.168.2.250
% Set LAN2 PPP(IPCP) Start IP done !!!

This setting will take effect after rebooting.
Please use "sys reboot" command to reboot the router.

> msubnet pppip ?
% msubnet pppip <2/3/4/5/6/7/8/dmz> <Start IP>
% Now: LAN2 192.168.2.250; LAN3 192.168.3.200; LAN4 192.168.4.200; LAN5
192.168.5.200; LAN6 192.168.6.200; LAN7 192.168.7.200; LAN8 192.168.8.200
```

### Telnet Command: msubnet nodetype

This command is used to specify the type for node which is required by DHCP option.

#### Syntax

`msubnet nodetype <2/3/4/5/6/7/8/dmz><count>`

#### Syntax Description

| Parameter                | Description                                                                                                                                              |
|--------------------------|----------------------------------------------------------------------------------------------------------------------------------------------------------|
| <i>2/3/4/5/6/7/8/dmz</i> | It means LAN interface.<br>2=LAN2<br>3=LAN3<br>4=LAN4<br>5=LAN5<br>6=LAN6<br>7=LAN7<br>8=LAN8<br>dmz=DMZ                                                 |
| <i>count</i>             | Choose the following number for specifying different node type.<br>1= B-node<br>2= P-node<br>4= M-node<br>8= H-node<br>0= Not specify any type for node. |

### Example

```
> msubnet nodetype ?
% msubnet nodetype <2/3/4/5/6/7/8/dmz> <count>
% Now: LAN2 0; LAN3 0; LAN4 0; LAN5 0; LAN6 0; LAN7 0; LAN8 0
```

```

% count: 1. B-node 2. P-node 4. M-node 8. H-node

> msubnet nodetype 2 1
% Set LAN2 Dhcp Node Type done !!!

> msubnet nodetype ?
% msubnet nodetype <2/3/4/5/6/7/8/dmz> <count>
% Now: LAN2 1; LAN3 0; LAN4 0; LAN5 0; LAN6 0; LAN7 0; LAN8 0

% count: 1. B-node 2. P-node 4. M-node 8. H-node

```

**Telnet Command: msubnet primWINS**

This command is used to configure primary WINS server.

**Syntax**

`msubnet primWINS <2/3/4/5/6/7/8/dmz><WINS IP>`

**Syntax Description**

| Parameter                | Description                                                                                              |
|--------------------------|----------------------------------------------------------------------------------------------------------|
| <i>2/3/4/5/6/7/8/dmz</i> | It means LAN interface.<br>2=LAN2<br>3=LAN3<br>4=LAN4<br>5=LAN5<br>6=LAN6<br>7=LAN7<br>8=LAN8<br>dmz=DMZ |
| <i>WINS IP</i>           | Enter the IP address as the WINS IP.                                                                     |

**Example**

```

> msubnet primWINS ?
% msubnet primWINS <2/3/4/5/6/7/8/dmz> <WINS IP>
% Now: LAN2 0.0.0.0; LAN3 0.0.0.0; LAN4 0.0.0.0; LAN5 0.0.0.0; LAN6 0.0.0.0;
LAN
7 0.0.0.0; LAN8 0.0.0.0

> msubnet primWINS 2 192.168.3.5
% Set LAN2 Dhcp Primary WINS IP done !!!

> msubnet primWINS ?
% msubnet primWINS <2/3/4/5/6/7/8/dmz> <WINS IP>
% Now: LAN2 192.168.3.5; LAN3 0.0.0.0; LAN4 0.0.0.0; LAN5 0.0.0.0; LAN6 0.0.0.0;
LAN7 0.0.0.0; LAN8 0.0.0.0

```

**Telnet Command: msubnet secWINS**

This command is used to configure secondary WINS server.

**Syntax**

`msubnet secWINS <2/3/4/5/6/7/8/dmz> <WINS IP>`

## Syntax Description

| Parameter                | Description                                                                                              |
|--------------------------|----------------------------------------------------------------------------------------------------------|
| <i>2/3/4/5/6/7/8/dmz</i> | It means LAN interface.<br>2=LAN2<br>3=LAN3<br>4=LAN4<br>5=LAN5<br>6=LAN6<br>7=LAN7<br>8=LAN8<br>dmz=DMZ |
| <i>WINS IP</i>           | Enter the IP address as the WINS IP.                                                                     |

## Example

```
> msubnet secWINS ?
% msubnet secWINS <2/3/4/5/6/7/8/dmz> <WINS IP>
% Now: LAN2 0.0.0.0; LAN3 0.0.0.0; LAN4 0.0.0.0; LAN5 0.0.0.0; LAN6 0.0.0.0;
LAN
7 0.0.0.0; LAN8 0.0.0.0
> msubnet secWINS 2 192.168.3.89
% Set LAN2 Dhcp Secondary WINS IP done !!!

> msubnet secWINS ?
% msubnet secWINS <2/3/4/5/6/7/8/dmz> <WINS IP>
% Now: LAN2 192.168.3.89; LAN3 0.0.0.0; LAN4 0.0.0.0; LAN5 0.0.0.0; LAN6
0.0.0.0; LAN7 0.0.0.0; LAN8 0.0.0.0
```

## Telnet Command: msubnet tftp

This command is used to set TFTP server for multi-subnet.

### Syntax

`msubnet tftp <2/3/4/5/6/7/8/dmz> <TFTP server name>`

### Syntax Description

| Parameter                | Description                                                                                              |
|--------------------------|----------------------------------------------------------------------------------------------------------|
| <i>2/3/4/5/6/7/8/dmz</i> | It means LAN interface.<br>2=LAN2<br>3=LAN3<br>4=LAN4<br>5=LAN5<br>6=LAN6<br>7=LAN7<br>8=LAN8<br>dmz=DMZ |
| <i>TFTP server name</i>  | Type a name to indicate the TFTP server.                                                                 |

## Example

```
> msubnet tftp ?
% msubnet tftp <2/3/4/5/6/7/8/dmz> <TFTP server name>
```

```

% Now: LAN2
    LAN3
    LAN4
    LAN5
    LAN6
    LAN7
    LAN8
> msubnet tftp 2 publish
% Set LAN2 TFTP Server Name done !!!

> msubnet tftp ?
% msubnet tftp <2/3/4/5/6/7/8/dmz> <TFTP server name>
% Now: LAN2 publish
    LAN3
    LAN4
    LAN5
    LAN6
    LAN7
    LAN8

```

## Telnet Command: msubnet mtu

This command allows you to configure MTU value for LAN/DMZ/IP Routed Subnet.

### Syntax

`msubnet mtu <interface><value>`

### Syntax Description

| Parameter        | Description                                                      |
|------------------|------------------------------------------------------------------|
| <i>interface</i> | Available settings include LAN1-LAN6, IP_Routed_Subnet, and DMZ. |
| <i>value</i>     | 1000 ~ 1500 (Bytes), default: 1500 (Bytes)                       |

### Example

```

> msubnet mtu LAN1 1492
> msubnet mtu ?
Usage:

>msubnet mtu <interface> <value>

<interface>: LAN1~LAN6,IP_Routed_Subnet,DMZ
<value>:     1000 ~ 1508 (Bytes), default: 1500 (Bytes)

e.x: >msubnet mtu LAN1 1492

Current Settings:

LAN1 MTU:           1500 (Bytes)
LAN2 MTU:           1500 (Bytes)
LAN3 MTU:           1500 (Bytes)
LAN4 MTU:           1500 (Bytes)
LAN5 MTU:           1500 (Bytes)

```

```

LAN6 MTU:          1500 (Bytes)
LAN7 MTU:          1500 (Bytes)
LAN8 MTU:          1500 (Bytes)
DMZ MTU:           1500 (Bytes)
IP Routed Subnet MTU: 1500 (Bytes)
>

```

## Telnet Command: msubnet leasetime

This command is used to set leasetime for multi-subnet.

### Syntax

`msubnet leasetime <1/2/3/4/5/6/7/8/dmz> <Lease Time sec.>`

### Syntax Description

| Parameter                  | Description                                                                                                        |
|----------------------------|--------------------------------------------------------------------------------------------------------------------|
| <i>1/2/3/4/5/6/7/8/dmz</i> | It means LAN interface.<br>1=LAN1<br>2=LAN2<br>3=LAN3<br>4=LAN4<br>5=LAN5<br>6=LAN6<br>7=LAN7<br>8=LAN8<br>dmz=DMZ |
| <i>Lease Time sec.</i>     | Enter a value (range: 10 to 259200).                                                                               |

### Example

```

> msubnet leasetime ?
% msubnet leasetime <1/2/3/4/5/6/7/8/dmz> <Lease Time (sec.)>
% Now:LAN1 86400; LAN2 259200; LAN3 259200; LAN4 259200; LAN5 259200; LAN6 25920
0; LAN7 259200; LAN8 259200; DMZ Port 259200
> msubnet leasetime 8 300
% Set LAN8 lease time: 300
>

```

## Telnet Command: object ip obj

This command is used to create an IP object profile.

### Syntax

```

object ip obj setdefault
object ip obj INDEX -v
object ip obj INDEX -n NAME
object ip obj INDEX -i INTERFACE
object ip obj INDEX -s INVERT
object ip obj INDEX -a TYPE <START_IP><END/MASK_IP>

```

### Syntax Description

| Parameter                  | Description                                                                                                                                                                                                               |
|----------------------------|---------------------------------------------------------------------------------------------------------------------------------------------------------------------------------------------------------------------------|
| <i>setdefault</i>          | It means to return to default settings for all profiles.                                                                                                                                                                  |
| <i>INDEX</i>               | It means the index number of the specified object profile.                                                                                                                                                                |
| <i>-v</i>                  | It means to view the information of the specified object profile.<br>Example: <i>object ip obj 1 -v</i>                                                                                                                   |
| <i>-n NAME</i>             | It means to define a name for the IP object.<br>NAME: Type a name with less than 15 characters.<br>Example: <i>object ip obj 9 -n bruce</i>                                                                               |
| <i>-i INTERFACE</i>        | It means to define an interface for the IP object.<br>INTERFACE=0, means any<br>INTERFACE=1, means LAN<br>INTERFACE=3, means WAN<br>Example: <i>object ip obj 8 -i 0</i>                                                  |
| <i>-s INVERT</i>           | It means to set invert selection for the object profile.<br>INVERT=0, means disableing the function.<br>INVERT=1, means enabling the function.<br>Example: <i>object ip obj 3 -s 1</i>                                    |
| <i>-a TYPE</i>             | It means to set the address type and IP for the IP object profile.<br>TYPE=0, means Mask<br>TYPE=1, means Single<br>TYPE=2, means Any<br>TYPE=3, means Range<br>TYPE=4, means MAC<br>Example: <i>object ip obj 3 -a 2</i> |
| <i>&lt;START_IP&gt;</i>    | When the TYPE is set with 2, you have to type an IP address as a starting point and another IP address as end point.<br>Type an IP address.                                                                               |
| <i>&lt;END/MASK_IP&gt;</i> | Type an IP address (different with START_IP) as the end IP address.                                                                                                                                                       |

## Example

```

> object ip obj 1 -n marketing
OK.
> object ip obj 1 -a 1 192.168.1.45
OK.
> object ip obj 1 -v
IP Object Profile 1
Name      :[marketing]
Interface:[Any]
Address type:[single]
Start ip address:[192.168.1.45]
End/Mask ip address:[0.0.0.0]
MAC Address:[00:00:00:00:00:00]
Invert Selection:[0]

```

## Telnet Command: object ip grp

This command is used to integrate several IP objects under an IP group profile.

### Syntax

```

object ip grp setdefault
object ip grp INDEX -v

```



object ip grp *INDEX* -n *NAME*  
 object ip grp *INDEX* -i *INTERFACE*  
 object ip grp *INDEX* -a *IP\_OBJ\_INDEX*

## Syntax Description

| Parameter              | Description                                                                                                                                                                                                |
|------------------------|------------------------------------------------------------------------------------------------------------------------------------------------------------------------------------------------------------|
| <i>setdefault</i>      | It means to return to default settings for all profiles.                                                                                                                                                   |
| <i>INDEX</i>           | It means the index number of the specified group profile.                                                                                                                                                  |
| -v                     | It means to view the information of the specified group profile.<br>Example: <i>object ip grp 1 -v</i>                                                                                                     |
| -n <i>NAME</i>         | It means to define a name for the IP group.<br>NAME: Type a name with less than 15 characters.<br>Example: <i>object ip grp 8 -n bruce</i>                                                                 |
| -i <i>INTERFACE</i>    | It means to define an interface for the IP group.<br>INTERFACE=0, means any<br>INTERFACE=1, means LAN<br>INTERFACE=2, means WAN<br>Example: <i>object ip grp 3 -i 0</i>                                    |
| -a <i>IP_OBJ_INDEX</i> | It means to specify IP object profiles for the group profile.<br>Example: <i>:object ip grp 3 -a 1 2 3 4 5</i><br>The IP object profiles with index number 1,2,3,4 and 5 will be group under such profile. |

## Example

```
> object ip grp 2 -n First
IP Group Profile 2
Name      :[First]
Interface:[Any]
Included ip object index:
[0:][0]
[1:][0]
[2:][0]
[3:][0]
[4:][0]
[5:][0]
[6:][0]
[7:][0]
[8:][0]
[9:][0]
[10:][0]
[11:][0]

> object ip grp 2 -i 1
IP Group Profile 2
Name      :[First]
Interface:[Lan]
Included ip object index:
[0:][0]
[1:][0]
[2:][0]
[3:][0]
```

```

[4:][0]
[5:][0]
[6:][0]
[7:][0]
[8:][0]
[9:][0]
[10:][0]
[11:][0]

Set ok!

```

## Telnet Command: object ipv6 obj

This command is used to create an IP object profile.

### Syntax

object ip obj setdefault

object ip obj *INDEX* -v

object ip obj *INDEX* -n *NAME*

object ip obj *INDEX* -i *INTERFACE*

object ip obj *INDEX* -s *INVERT*

object ip obj *INDEX* -a *TYPE* <*START\_IP*><*END\_IP*>/<*Prefix Length*>

### Syntax Description

| Parameter           | Description                                                                                                                                                                                                                 |
|---------------------|-----------------------------------------------------------------------------------------------------------------------------------------------------------------------------------------------------------------------------|
| <i>setdefault</i>   | It means to return to default settings for all profiles.                                                                                                                                                                    |
| <i>INDEX</i>        | It means the index number of the specified object profile.                                                                                                                                                                  |
| -v                  | It means to view the information of the specified object profile.<br>Example: <i>object ip obj 1 -v</i>                                                                                                                     |
| -n <i>NAME</i>      | It means to define a name for the IPv6 object.<br>NAME: Type a name with less than 15 characters.<br>Example: <i>object ip obj 9 -n bruce</i>                                                                               |
| -i <i>INTERFACE</i> | It means to define an interface for the IP object.<br>INTERFACE=0, means any<br>INTERFACE=1, means LAN<br>INTERFACE=3, means WAN<br>Example: <i>object ip obj 8 -i 0</i>                                                    |
| -s <i>INVERT</i>    | It means to set invert selection for the object profile.<br>INVERT=0, means disabling the function.<br>INVERT=1, means enabling the function.<br>Example: <i>object ip obj 3 -s 1</i>                                       |
| -e [0/1]            | It means to set the match type of the IPv6 object profile.<br>0: means 128 Bits<br>1: means suffix 64 bits interface ID.                                                                                                    |
| -a <i>TYPE</i>      | It means to set the address type and IP for the IPv6 object profile.<br>TYPE=0, means Mask<br>TYPE=1, means Single<br>TYPE=2, means Any<br>TYPE=3, means Range<br>TYPE=4, means MAC<br>Example: <i>object ip obj 3 -a 2</i> |

|                    |                                                                                                                                                                                      |
|--------------------|--------------------------------------------------------------------------------------------------------------------------------------------------------------------------------------|
| <START_IP><END_IP> | When the TYPE is set with 0, 1,3, you have to type an IP address as a starting point and another IP address as end point.<br>Type the IP address(es) based on the selection of TYPE. |
| <Prefix Length>    | When the TYPE is set with 0, 1 or 3, you have to enter a number as prefix length for the IPv6 address.                                                                               |

## Example

```
> obj ipv6 obj 3 -a 3 2607:f0d0:1002:51::4 2607:f0d0:1002:51::4
Setting saved.
> obj ipv6 obj 3 -v
IPv6 Object Profile 3
Name      :[]
Address Type:[range]
Start IPv6 Address:[2607:F0D0:1002:51::4]
End IPv6 Address:[2607:F0D0:1002:51::4]
Prefix Length:[0]
MAC Address:[00:00:00:00:00:00]
Invert Selection:[0]
Match Type:[0]
```

## Telnet Command: object ipv6 grp

This command is used to integrate several IP objects under an IP group profile.

### Syntax

```
object ip grp setdefault
object ip grp INDEX -v
object ip grp INDEX -n NAME
object ip grp INDEX -a IP_OBJ_INDEX
```

### Syntax Description

| Parameter              | Description                                                                                                                                                                                                |
|------------------------|------------------------------------------------------------------------------------------------------------------------------------------------------------------------------------------------------------|
| <i>setdefault</i>      | It means to return to default settings for all profiles.                                                                                                                                                   |
| <i>INDEX</i>           | It means the index number of the specified group profile.                                                                                                                                                  |
| <i>-v</i>              | It means to view the information of the specified group profile.<br>Example: <i>object ip grp 1 -v</i>                                                                                                     |
| <i>-n NAME</i>         | It means to define a name for the IP group.<br>NAME: Type a name with less than 15 characters.<br>Example: <i>object ip grp 8 -n bruce</i>                                                                 |
| <i>-a IP_OBJ_INDEX</i> | It means to specify IP object profiles for the group profile.<br>Example: <i>:object ip grp 3 -a 1 2 3 4 5</i><br>The IP object profiles with index number 1,2,3,4 and 5 will be group under such profile. |

## Example

```
> object ipv6 grp 1 -n marketingtest
IP Group Profile 1
Name      :[marketingtest]
Included ip object index:
[0:][0]
[1:][0]
```

```

[2:][0]
[3:][0]
[4:][0]
[5:][0]
[6:][0]
[7:][0]

> object ipv6 grp 1 -a 1 2 3 4 5
IPv6 Group Profile 1
Name      :[marketingtest]
Included ip object index:
[0:][1]
[1:][2]
[2:][3]
[3:][4]
[4:][5]
[5:][0]
[6:][0]
[7:][0]

```

## Telnet Command: object country

This command is used to create country object profile.

### Syntax

```

object country set INDEX -v
object country set INDEX -n NAME
object country set INDEX -a COUNTRY_INDEX
object country activate
object country setdefault
object country list

```

### Syntax Description

| Parameter            | Description                                                                                                                                   |
|----------------------|-----------------------------------------------------------------------------------------------------------------------------------------------|
| <i>INDEX</i>         | It means the index number of the specified country object profile (1 to 32).                                                                  |
| <i>-n NAME</i>       | It means to define a name for country object proffile.                                                                                        |
| <i>COUNTRY_INDEX</i> | It means the code number of a country. To get the detailed information of the code number, use "object country list" to get the one you need. |
| <i>activate</i>      | It means to activate the country object profile.                                                                                              |
| <i>setdefault</i>    | It means to return to default settings for all profiles.                                                                                      |
| <i>list</i>          | Displays a list of country with code number.<br>For example, "222" means "Taiwan"; "241" means "United States".                               |

### Example

```

> object country set 1 -n Best
Country object Profile 1
Name      :[Best]
Included country index:

Set ok!
> object country set 1 -a 222

```

```
Country object Profile 1
Name   :[Best]
Included country index:
[0:][222] Taiwan

Set ok!
```

## Telnet Command: object service obj

This command is used to create service object profile.

### Syntax

**object service obj setdefault**

**object service obj INDEX -v**

**object service obj INDEX -n NAME**

**object service obj INDEX -p PROTOCOL**

**object service obj INDEX -s CHK <START\_P><END\_P>**

**object service obj INDEX -d CHK <START\_P><END\_P>**

### Syntax Description

| Parameter          | Description                                                                                                                                                                                                                                                                                                                                                                                                                                                                                                                                                                                                                                                                                                                                             |
|--------------------|---------------------------------------------------------------------------------------------------------------------------------------------------------------------------------------------------------------------------------------------------------------------------------------------------------------------------------------------------------------------------------------------------------------------------------------------------------------------------------------------------------------------------------------------------------------------------------------------------------------------------------------------------------------------------------------------------------------------------------------------------------|
| <i>setdefault</i>  | It means to return to default settings for all profiles.                                                                                                                                                                                                                                                                                                                                                                                                                                                                                                                                                                                                                                                                                                |
| <i>INDEX</i>       | It means the index number of the specified service object profile.                                                                                                                                                                                                                                                                                                                                                                                                                                                                                                                                                                                                                                                                                      |
| <i>-v</i>          | It means to view the information of the specified service object profile.<br>Example: <i>object service obj 1 -v</i>                                                                                                                                                                                                                                                                                                                                                                                                                                                                                                                                                                                                                                    |
| <i>-n NAME</i>     | It means to define a name for the IP object.<br>NAME: Type a name with less than 15 characters.<br>Example: <i>object service obj 9 -n bruce</i>                                                                                                                                                                                                                                                                                                                                                                                                                                                                                                                                                                                                        |
| <i>-i PROTOCOL</i> | It means to define a PROTOCOL for the service object profile.<br>PROTOCOL =0, means any<br>PROTOCOL =1, means ICMP<br>PROTOCOL =2, means IGMP<br>PROTOCOL =6, means TCP<br>PROTOCOL =17, means UDP<br>PROTOCOL =58, means ICMPv6<br>PROTOCOL =255, means TCP/UDP<br>Other values mean other protocols.<br>Example: <i>object service obj 8 -i 0</i>                                                                                                                                                                                                                                                                                                                                                                                                     |
| <i>CHK</i>         | It means the check action for the port setting.<br>0=equal(=), when the starting port and ending port values are the same, it indicates one port; when the starting port and ending port values are different, it indicates a range for the port and available for this service type.<br>1=not equal(!=), when the starting port and ending port values are the same, it indicates all the ports except the port defined here; when the starting port and ending port values are different, it indicates that all the ports except the range defined here are available for this service type.<br>2=larger(>), the port number greater than this value is available..<br>3=less(<), the port number less than this value is available for this profile. |

|                                                  |                                                                                                                                                                                                                                                                                               |
|--------------------------------------------------|-----------------------------------------------------------------------------------------------------------------------------------------------------------------------------------------------------------------------------------------------------------------------------------------------|
| <code>-s CHK &lt;START_P&gt;&lt;END_P&gt;</code> | It means to set source port check and configure port range (1-65565) for TCP/UDP.<br>START_P: Enter a port number to indicate the starting source port.<br>END_P: Enter a port number to indicate the ending source port.<br>Example: <i>object service obj 3 -s 0 100 200</i>                |
| <code>-d CHK &lt;START_P&gt;&lt;END_P&gt;</code> | It means to set destination port check and configure port range (1-65565) for TCP/UDP.<br>START_P: Enter a port number to indicate the starting destination port.<br>END_P: Enter a port number to indicate the ending destination port.<br>Example: <i>object service obj 3 -d 1 100 200</i> |

## Example

```
> object service obj 1 -n limit
> object service obj 1 -p 255
> object service obj 1 -s 1 120 240
> object service obj 1 -d 1 200 220
> object service obj 1 -v
Service Object Profile 1
Name      :[limit]
Protocol  :[255]
Source port check action:[!]=]
Source port range:[120~240]
Destination port check action:[!]=]
Destination port range:[200~220]
```

## Telnet Command: object service grp

This command is used to integrate several service objects under a service group profile.

### Syntax

```
object service grp setdefault
object service grp INDEX -v
object service grp INDEX -n NAME
object service grp INDEX -a SER_OBJ_INDEX
```

### Syntax Description

| Parameter               | Description                                                                                                                                                                                                               |
|-------------------------|---------------------------------------------------------------------------------------------------------------------------------------------------------------------------------------------------------------------------|
| <i>setdefault</i>       | It means to return to default settings for all profiles.                                                                                                                                                                  |
| <i>INDEX</i>            | It means the index number of the specified group profile.                                                                                                                                                                 |
| <i>-v</i>               | It means to view the information of the specified group profile.<br>Example: <i>object service grp 1 -v</i>                                                                                                               |
| <i>-n NAME</i>          | It means to define a name for the service group.<br>NAME: Type a name with less than 15 characters.<br>Example: <i>object service grp 8 -n bruce</i>                                                                      |
| <i>-a SER_OBJ_INDEX</i> | It means to specify service object profiles for the group profile.<br>Example: <i>:object service grp 3 -a 1 2 3 4 5</i><br>The service object profiles with index number 1,2,3,4 and 5 will be group under such profile. |

## Example

```

>object service grp 1 -n Grope_1
Service Group Profile 1
Name   :[Grope_1]
Included service object index:
[0:][0]
[1:][0]
[2:][0]
[3:][0]
[4:][0]
[5:][0]
[6:][0]
[7:][0]

> object service grp 1 -a 1 2
Service Group Profile 1
Name   :[Grope_1]
Included service object index:
[0:][1]
[1:][2]
[2:][0]
[3:][0]
[4:][0]
[5:][0]
[6:][0]
[7:][0]

```

## Telnet Command: object kw

This command is used to create keyword profile.

### Syntax

```

object kw obj setdefault
object kw obj show PAGE
object kw obj INDEX -v
object kw obj INDEX -n NAME
object kw obj INDEX -a CONTENTS
object kw obj INDEX -c
object kw obj INDEX -t

```

### Syntax Description

| Parameter          | Description                                                                                           |
|--------------------|-------------------------------------------------------------------------------------------------------|
| <i>setdefault</i>  | It means to return to default settings for all profiles.                                              |
| <i>show PAGE</i>   | It means to show the contents of the specified profile.<br>PAGE: Enter the page number.               |
| <i>show</i>        | It means to show the contents for all of the profiles.                                                |
| <i>INDEX</i>       | It means the index number of the specified keyword profile.                                           |
| <i>-v</i>          | It means to view the information of the specified keyword profile.                                    |
| <i>-n NAME</i>     | It means to define a name for the keyword profile.<br>NAME: Type a name with less than 15 characters. |
| <i>-a CONTENTS</i> | It means to set the contents for the keyword profile.<br>Example: <i>object kw obj 40 -a test</i>     |

|                             |                                                                          |
|-----------------------------|--------------------------------------------------------------------------|
| <code>-c</code>             | It means to clear the content of the keyword object profile.             |
| <code>-t &lt;0/1&gt;</code> | It means to set keyword object type.<br><0>: normal<br><1> : domain name |

## Example

```

> object kw obj 1 -n children
Profile 1
Name   :[children]
Type   :[Normal]
Content:[]
> object kw obj 1 -a gambling
Profile 1
Name   :[children]
Type   :[Normal]
Content:[gambling]

> object kw obj 1 -v
Profile 1
Name   :[children]
Type   :[Normal]
Content:[gambling]

```

## Telnet Command: object fe

This command is used to create File Extension Object profile.

### Syntax

`object fe show`

`object fe setdefault`

`object fe obj INDEX -v`

`object fe obj INDEX -n NAME`

`object fe obj INDEX -e CATEGORY|FILE_EXTENSION`

`object fe obj INDEX -d CATEGORY|FILE_EXTENSION`

### Syntax Description

| Parameter                            | Description                                                                                                         |
|--------------------------------------|---------------------------------------------------------------------------------------------------------------------|
| <code>show</code>                    | It means to show the contents for all of the profiles.                                                              |
| <code>setdefault</code>              | It means to return to default settings for all profiles.                                                            |
| <code>INDEX</code>                   | It means the index number (from 1 to 8) of the specified file extension object profile.                             |
| <code>-v</code>                      | It means to view the information of the specified file extension object profile.                                    |
| <code>-n NAME</code>                 | It means to define a name for the file extension object profile.<br>NAME: Type a name with less than 15 characters. |
| <code>-e</code>                      | It means to enable the specific CATEGORY or FILE_EXTENSION.                                                         |
| <code>-d</code>                      | It means to disable the specific CATEGORY or FILE_EXTENSION                                                         |
| <code>CATEGORY FILE_EXTENSION</code> | CATEGORY:<br>Image, Video, Audio, Java, ActiveX, Compression, Execution                                             |



Example: *object fe obj 1 -e Image*

FILE\_EXTENSION:

".bmp", ".dib", ".gif", ".jpeg", ".jpg", ".jpg2", ".jp2", ".pct",  
".pcx", ".pic", ".pict", ".png", ".tif", ".tiff", ".asf", ".avi",  
".mov", ".mpe", ".mpeg", ".mpg", ".mp4", ".qt", ".rm", ".wmv",  
".3gp", ".3gpp", ".3gpp2", ".3g2", ".aac", ".aiff", ".au", ".mp3",  
".m4a", ".m4p", ".ogg", ".ra", ".ram", ".vox", ".wav", ".wma",  
".class", ".jad", ".jar", ".jav", ".java", ".jcm", ".js", ".jse",  
".jsp", ".jtk", ".alx", ".apb", ".axs", ".ocx", ".olb", ".ole",  
".tlb", ".viv", ".vrm", ".ace", ".arj", ".bzip2", ".bz2", ".cab",  
".gz", ".gzip", ".rar", ".sit", ".zip", ".bas", ".bat", ".com",  
".exe", ".inf", ".pif", ".reg", ".scr", ".torrent", ".doc", ".docx", ".odp",  
".ods", ".odt", ".pdf", ".ppt", ".pptx", ".xls", ".xlsx

Example: *object fe obj 1 -e .bmp*

## Example

```
> object fe obj 1 -n music
> object fe obj 1 -e Audio
> object fe obj 1 -v
Profile Index: 1
Profile Name:[music]

-----
Image category:
[ ].bmp [ ].dib [ ].gif [ ].jpeg [ ].jpg [ ].jpg2 [ ].jp2 [ ].pct
[ ].pcx [ ].pic [ ].pict [ ].png [ ].tif [ ].tiff [ ].ico
-----
Video category:
[ ].asf [ ].avi [ ].mov [ ].mpe [ ].mpeg [ ].mpg [v].mp4 [ ].qt
[ ].rm [v].wmv [ ].3gp [ ].3gpp [ ].3gpp2 [ ].3g2 [ ].flv [ ].swf
-----
Audio category:
[v].aac [v].aiff [v].au [v].mp3 [v].m4a [v].m4p [v].ogg [v].ra
[v].ram [v].vox [v].wav [v].wma
-----
Java category:
[ ].class [ ].jad [ ].jar [ ].jav [ ].java [ ].jcm [ ].js [ ].jse
[ ].jsp [ ].jtk
-----
ActiveX category:
[ ].alx [ ].apb [ ].axs [ ].ocx [ ].olb [ ].ole [ ].tlb [ ].viv
[ ].vrm
-----
Compression category:
[ ].ace [ ].arj [ ].bzip2 [ ].bz2 [ ].cab [ ].gz [ ].gzip [ ].rar
[ ].sit [ ].zip
-----
Execution category:
[ ].bas [ ].bat [ ].com [ ].exe [ ].inf [ ].pif [ ].reg [ ].scr
-----
P2P category:
[ ].torrent
-----
Document category:
```

|          |           |          |          |          |          |          |           |
|----------|-----------|----------|----------|----------|----------|----------|-----------|
| [ ] .doc | [ ] .docx | [ ] .odp | [ ] .ods | [ ] .odt | [ ] .pdf | [ ] .ppt | [ ] .pptx |
| [ ] .xls | [ ] .xlsx |          |          |          |          |          |           |

## Telnet Command: object sms

This command is used to create short message object profile.

### Syntax

```
object sms show
object sms setdefault
object sms obj INDEX -v
object sms obj INDEX -n NAME
object sms obj INDEX -s Service Provider
object sms obj INDEX -u Username
object sms obj INDEX -p Password
object sms obj INDEX -q Quota
object sms obj INDEX -i Interval
object sms obj INDEX -I URL
```

### Syntax Description

| Parameter                      | Description                                                                                                                                                                                                                                                                                                                                                                                                                                                                                                                            |
|--------------------------------|----------------------------------------------------------------------------------------------------------------------------------------------------------------------------------------------------------------------------------------------------------------------------------------------------------------------------------------------------------------------------------------------------------------------------------------------------------------------------------------------------------------------------------------|
| <i>show</i>                    | It means to show the contents for all of the profiles.                                                                                                                                                                                                                                                                                                                                                                                                                                                                                 |
| <i>setdefault</i>              | It means to return to default settings for all profiles.                                                                                                                                                                                                                                                                                                                                                                                                                                                                               |
| < <i>INDEX</i> >               | It means the index number (from 1 to 10) of the specified SMS object profile.                                                                                                                                                                                                                                                                                                                                                                                                                                                          |
| -v                             | It means to view the information of the specified SMS object profile.                                                                                                                                                                                                                                                                                                                                                                                                                                                                  |
| -n < <i>NAME</i> >             | It means to define a name for the SMS object profile.<br>NAME: Type a name with less than 15 characters.                                                                                                                                                                                                                                                                                                                                                                                                                               |
| -s < <i>Service Provider</i> > | It means to specify the number of the service provider which offers the service of SMS. Different numbers represent different service provider.<br>0 : kotsms.com.tw (TW)<br>2 : textmarketer.co.uk (UK)<br>4 : messagemedia.co.uk (UK)<br>5 : bulksms.com (INT)<br>6 : bulksms.co.uk (UK)<br>7 : bulksms.2way.co.za (ZA)<br>8 : bulksms.com.es (ES)<br>9 : usa.bulksms.com (US)<br>10 : bulksms.de (DE)<br>11 : www.pswin.com (EU)<br>12 : www.messagebird.com (EU)<br>13 : www.lusosms.com (EU)<br>14 : www.vibeactivemedia.com (UK) |
| -u < <i>Username</i> >         | It means to define a user name for the SMS object profile.<br>Type a user name that the sender can use to register to selected SMS provider.                                                                                                                                                                                                                                                                                                                                                                                           |
| -p < <i>Password</i> >         | It means to define a password for the SMS object profile.<br>Type a password that the sender can use to register to selected SMS                                                                                                                                                                                                                                                                                                                                                                                                       |

|                            |                                                                                                                                                           |
|----------------------------|-----------------------------------------------------------------------------------------------------------------------------------------------------------|
|                            | provider.                                                                                                                                                 |
| <i>-q &lt;Quota&gt;</i>    | Enter the number of the credit that you purchase from the service provider.<br>Note that one credit equals to one SMS text message on the standard route. |
| <i>-I &lt;Interval&gt;</i> | It means to set the sending interval for the SMS to be delivered.<br>Enter the shortest time interval for the system to send SMS.                         |
| <i>-I &lt;URL&gt;</i>      | It means to set the URL for Custom 1 and Custom 2 profiles.<br>The profile name for Custom 1 and Custom 2 are defined in default and can not be changed.  |

### Example

```

> object sms obj 1 -n CTC
> object sms obj 1 -s 0
> object sms obj 1 -u carrie
> object sms obj 1 -p 19971125cm
> object sms obj 1 -q 2
> object sms obj 1 -i 50
> object sms obj 1 -v
Profile Index: 1
Profile Name:[CTC]
SMS Provider:[kotsms.com.tw (TW)]
Username:[carrie]
Password:[*****]
Quota:[2]
Sending Interval:[50(seconds)]

```

### Telnet Command: object mail

This command is used to create mail object profile.

#### Syntax

```

object mail show
object mail setdefault
object mail obj INDEX -v
object mail obj INDEX -n <Profile Name>
object mail obj INDEX -s <SMTP Server>
object mail obj INDEX -I <Connection security>
object mail obj INDEX -m <SMTP Port>
object mail obj INDEX -a <Sender Address>
object mail obj INDEX -t <Authentication>
object mail obj INDEX -u <Username>
object mail obj INDEX -p <Password>
object mail obj INDEX -i <Sending Interval>
object mail obj INDEX -w <Interface>
object mail obj INDEX -x <Alias IP Index>

```

#### Syntax Description

| Parameter         | Description                                                                    |
|-------------------|--------------------------------------------------------------------------------|
| <i>show</i>       | It means to show the contents for all of the profiles.                         |
| <i>setdefault</i> | It means to return to default settings for all profiles.                       |
| <i>[INDEX]</i>    | It means the index number (from 1 to 10) of the specified mail object profile. |
| <i>-v</i>         | It means to view the information of the specified mail object profile.         |

|                                             |                                                                                                                                                                             |
|---------------------------------------------|-----------------------------------------------------------------------------------------------------------------------------------------------------------------------------|
| <code>-n &lt;Profile Name&gt;</code>        | It means to define a name for the mail object profile.<br><i>Profile Name:</i> Type a name with less than 15 characters.                                                    |
| <code>-s &lt;SMTP Server&gt;</code>         | It means to set the IP address of the mail server.                                                                                                                          |
| <code>-I &lt;Connection security&gt;</code> | It means to set the connection security for the object profile.<br>0 - (Plaintext)<br>1 - (SSL)<br>2 - (StartTLS ,nice to have)<br>3 - (StartTLS ,MUST)                     |
| <code>-m &lt;SMTP Port&gt;</code>           | It means to set the port number for SMTP server.                                                                                                                            |
| <code>-a &lt;Sender Address&gt;</code>      | It means to set the e-mail address (e.g., johnwash@abc.com.tw) of the sender.                                                                                               |
| <code>-t &lt;Authentication&gt;</code>      | The mail server must be authenticated with the correct username and password to have the right of sending message out.<br>0 - disable<br>1 - enable to use the port number. |
| <code>-u &lt;Username&gt;</code>            | Type a name for authentication. The maximum length of the name you can set is 31 characters.                                                                                |
| <code>-p &lt;Password&gt;</code>            | Type a password for authentication. The maximum length of the password you can set is 31 characters.                                                                        |
| <code>-i &lt;Sending Interval&gt;</code>    | Define the interval for the system to send the SMS out. The unit is second.                                                                                                 |
| <code>-w &lt;Interface&gt;</code>           | Set the interface of the mail server profile.                                                                                                                               |
| <code>-x &lt;Alias IP Index&gt;</code>      | Set the alias IP of mail server profile (1 to 10).                                                                                                                          |

### Example

```

> object mail obj 1 -n buyer
> object mail obj 1 -s 192.168.1.98
> object mail obj 1 -m 25
> object mail obj 1 -t 1
> object mail obj 1 -u john
> object mail obj 1 -p happy123456
> object mail obj 1 -i 25
> object mail obj 1 -v
Profile Index: 1
Interface:[WAN1]
Alias IP Index:[0]
Profile Name:[buyer]
SMTP Server:[192.168.1.98]
SMTP Port:[25]
Sender Address:[carrie@draytek.com]
Connection Security:[StartTLS(Nice to have)]
Authentication:[enable]
Username:[john]
Password:[*****]
Sending Interval:[25(seconds)]

```

### Telnet Command: object noti

This command is used to create notification object profile.

#### Syntax

```

object noti show
object noti setdefault
object noti obj INDEX -v
object noti obj INDEX -n <Profile Name>
object mail obj INDEX -e <Category><Status>

```

object mail obj INDEX -d <Category><Status>

## Syntax Description

| Parameter         | Description                                                                                                                                                                                                                                                                                                                                                                                                                                                                                                                                                                                                                               |
|-------------------|-------------------------------------------------------------------------------------------------------------------------------------------------------------------------------------------------------------------------------------------------------------------------------------------------------------------------------------------------------------------------------------------------------------------------------------------------------------------------------------------------------------------------------------------------------------------------------------------------------------------------------------------|
| <i>show</i>       | It means to show the contents for all of the profiles.                                                                                                                                                                                                                                                                                                                                                                                                                                                                                                                                                                                    |
| <i>setdefault</i> | It means to return to default settings for all profiles.                                                                                                                                                                                                                                                                                                                                                                                                                                                                                                                                                                                  |
| <INDEX>           | It means the index number (from 1 to 8) of the specified notification object profile.                                                                                                                                                                                                                                                                                                                                                                                                                                                                                                                                                     |
| -v                | It means to view the information of the specified notification object profile.                                                                                                                                                                                                                                                                                                                                                                                                                                                                                                                                                            |
| -n <Profile Name> | It means to define a name for the notification object profile.<br><i>Profile Name:</i> Type a name with less than 15 characters.                                                                                                                                                                                                                                                                                                                                                                                                                                                                                                          |
| -e                | It means to enable the status of specified category.                                                                                                                                                                                                                                                                                                                                                                                                                                                                                                                                                                                      |
| -d                | It means to disable the status of specified category.                                                                                                                                                                                                                                                                                                                                                                                                                                                                                                                                                                                     |
| <Category>        | Available categories are:<br>1: WAN; 2: VPN Tunnel; 3: Temperature Alert;<br>4: WAN Budget; 5: CVM; 6: High Availability; 9:Security                                                                                                                                                                                                                                                                                                                                                                                                                                                                                                      |
| <status>          | For WAN -<br>1: Disconnected; 2: Reconnected.<br>For VPN Tunnel -<br>1: Disconnected; 2: Reconnected.<br>For Temperature Alert -<br>1: Out of Range.<br>For WAN Budget -<br>1: Limit Reached.<br>For CVM -<br>1: CPE Offline; 2: Backup Fail; 3: Restore Fail; 4: FW Update Fail;<br>5: VPN Profile Setup Fail.<br>For High Availability -<br>1: Failover Occurred, Config Sync Fail, and Router Unstable<br>For Security -<br>1 : Web Log-in event occurs.<br>2 : Telnet Log-in event occurs.<br>3 : SSH Log-in event occurs.<br>4 : TR069 Log-in event occurs.<br>5 : FTP User Log-in event occurs.<br>6 : Config-Changed event occurs. |

## Example

```
> object noti obj 1 -n market
> object noti obj 1 -e 1 1
> object noti obj 1 -e 2 1
> object noti obj 1 -e 5 3
> object noti obj 1 -v
Profile Index: 1
Profile Name:[]
      Category                Status
WAN          [v]Disconnected    [ ]Reconnected
VPN Tunnel   [v]Disconnected    [ ]Reconnected
```

|                   |                                 |
|-------------------|---------------------------------|
| Temperature Alert | [ ]USB Temperature Out of Range |
| WAN Budget Alert  | [ ]Limit Reached                |
| CVM Alert         | [ ]CPE Offline                  |
|                   | [ ]CPE Config Backup Fail       |
|                   | [v]CPE Config Restore Fail      |
|                   | [ ]CPE Firmware Fpgrade Fail    |
|                   | [ ]CPE VPN Profile Setup Fail   |
| High Availability | [ ]Failover Occurred            |
|                   | Config Sync Fail                |
|                   | Router Unstable                 |
| Security          | [ ]Web Log-in event occurs      |
|                   | [ ]Telnet Log-in event occurs   |
|                   | [ ]SSH Log-in event occurs      |
|                   | [ ]TR069 Log-in event occurs    |
|                   | [ ]FTP User Log-in event occurs |
|                   | [ ]Config-Changed event occurs  |

## Telnet Command: object schedule

This command is used to create schedule object profile.

### Syntax

object schedule set *INDEX option*

object schedule view

object schedule setdefault

### Syntax Description

| Parameter                                        | Description                                                                                                                                                                                                                                                     |
|--------------------------------------------------|-----------------------------------------------------------------------------------------------------------------------------------------------------------------------------------------------------------------------------------------------------------------|
| <i>set</i>                                       | It means to set the schedule profile.                                                                                                                                                                                                                           |
| < <i>INDEX</i> >                                 | It means the index number (from 1 to 15) of the specified object profile.                                                                                                                                                                                       |
| <i>option</i>                                    | Available options for schedule.                                                                                                                                                                                                                                 |
| -e < <i>value</i> >                              | It means to enable the schedule setup.<br>0 - disable<br>1 - enable                                                                                                                                                                                             |
| -c < <i>comment</i> >                            | It means to set brief description for the specified profile.<br>The length range of the comment: 0 ~ 32 characters.                                                                                                                                             |
| -D < <i>year</i> >< <i>month</i> >< <i>day</i> > | It means to set the starting date of the profile.<br>[year] - Must be between 2000-2049.<br>[month] - Must be between 1-12.<br>[day] - Must be between 1-31.<br>For example: To set Start Date 2015/10/6, type<br>> <i>object schedule set 1 -D "2015 10 6"</i> |
| -T < <i>hour</i> >< <i>minute</i> >              | It means to set the starting time of the profile.<br>[hour] - Must be between 0-23.<br>[minute] - Must be between 0-59.<br>For example: To set Start Time 10:20, type<br>> <i>object schedule set 1 -T "10 20"</i>                                              |
| -d < <i>hour</i> >< <i>minute</i> >              | It means to set the duration time of the profile.<br>[hour] - Must be between 0-23.<br>[minute] - Must be between 0-59.<br>For example: To set Duration Time 3:30, type<br>> <i>object schedule set 1 -d "3 30"</i>                                             |
| -a < <i>value</i> >                              | It means to set the action used for the profile.<br>[value] -<br>0:Force On, 1:Force Down, 2:Enable Dial-On-Demand, 3:Disable                                                                                                                                   |

|                  |                                                                                                                                                                                                                                                                                                                                     |
|------------------|-------------------------------------------------------------------------------------------------------------------------------------------------------------------------------------------------------------------------------------------------------------------------------------------------------------------------------------|
|                  | Dial-On-Demand                                                                                                                                                                                                                                                                                                                      |
| -l <value>       | It means to set idle time.<br>[value] - Must be between 0-255(minute). The default is 0.                                                                                                                                                                                                                                            |
| -h <option><day> | Set how often the schedule will be applied.<br>[option] -<br>0: Once, 1: Weekdays, 2:Monthly, 3:Cycle days<br>[day] -<br>Sun, Mon, Tue, Wed, Thu, Fri, Sat<br>If the [option] set Weekdays, then must select which days of Week.<br>example: To select Sunday, Monday, Thursday, type<br>> object schedule set 1 -h "1 Sun Mon Thu" |
| view [INDEX]     | It means to show the content of the profile.                                                                                                                                                                                                                                                                                        |
| setdefault       | It means to return to default settings for all profiles.                                                                                                                                                                                                                                                                            |

## Example

```

> object schedule set 1 -e 1
> object schedule set 1 -c Working
> object schedule set 1 -D "2021 10 8"
> object schedule set 1 -T "8 1"
> object schedule set 1 -d "2 30"
> object schedule set 1 -a 0
> object schedule set 1 -h "1 Mon Wed"
> object schedule view 1
Index No.1

-----
[v] Enable Schedule Setup
  Comment [ Working ]
  Start Date (yyyy-mm-dd) [ 2021 ]-[ 10 ]-[ 8 ]
  Start Time (hh:mm)      [ 8 ]:[ 1 ]
  Duration Time (hh:mm)   [ 2 ]:[ 30 ]
  Action                   [ Force On ]
  Idle Timeout             [ 0 ] minute(s).(max. 255, 0 for
                           default)

-----
How Often
  [ ] Once
  [v] Weekdays
     [ ]Sun [v]Mon [ ]Tue [v]Wed [ ]Thu [ ]Fri [ ]Sat
>

```

## Telnet Command: port

This command allows users to set the speed for specific port of the router.

### Syntax

port <1, 2, 3, 4, 5, all> <AN, 1G, 100F, 100H, 10F, 10H, status>

port <wan1, wan2> <AN, 1000F, 100F, 100H, 10F, 10H, status>

port <enable, disable> <1, 2, 3, 4, 5, all>

port status

port sniff <on,off,port,txrx,restart,status>

port 802.1x <enable,disable,status,addport,delport>  
port jumbo  
port wanfc

### Syntax Description

| Parameter                                         | Description                                                                                                                                                                                                                                                                                                                                                                                                                    |
|---------------------------------------------------|--------------------------------------------------------------------------------------------------------------------------------------------------------------------------------------------------------------------------------------------------------------------------------------------------------------------------------------------------------------------------------------------------------------------------------|
| 1, 2, 3, 4, 5, wan1, wan2, all                    | It means the number of LAN port and WAN port.                                                                                                                                                                                                                                                                                                                                                                                  |
| AN... 10H                                         | It means the physical type for the specific port.<br>AN: auto-negotiate.<br>1G: 1G<br>100F: 100M Full Duplex.<br>100H: 100M Half Duplex.<br>10F: 10M Full Duplex.<br>10H: 10M Half Duplex.                                                                                                                                                                                                                                     |
| status                                            | It means to view the Ethernet port status.                                                                                                                                                                                                                                                                                                                                                                                     |
| sniff<br><on,off,port,txrx,restart,status>        | It means to set settings for sniffer.<br><on,off,port,txrx,restart,status>: See the following,<br>on - Turn on the sniffer.<br>off - Turn off the sniffer.<br>port - Specify a LAN port (p1, p2, p3, p4, p5 or p6).<br>restart - Restart the system to activate the settings.<br>status - Display current settings.<br>rxrx - Set the transmission and receiving rates for a LAN/WAN port.<br>e.g., > port sniff txrx 30000 p2 |
| 802.1x<br><enable,disable,status,addport,delport> | It means to set settings for 802.1x.<br><enable,disable,status,addport,delport>: See the following,<br>enable - Enable the function.<br>disable - Disable the function.<br>status - Display current settings.<br>addport - Add a port number (1 to 5).<br>delport - Delete a port number (1 to 5).                                                                                                                             |
| jumbo <on/off>                                    | It means to enable (on) or disable (off) the Jumbo frame function.                                                                                                                                                                                                                                                                                                                                                             |
| jumbo size <value>                                | If jumbo is enabled, set a jumbo size.<br><value>: 1537 to 9022. Set a number.                                                                                                                                                                                                                                                                                                                                                 |
| wanfc <INDEX><br><on/off/status>                  | It means to set WAN flow control.<br><INDEX>: Enter the index number (1 to 4) of the WAN interface.<br><on/off/status>: Enter "on" to enable the function; enter "off" to disable the function; enter "status" to view current settings.                                                                                                                                                                                       |

### Example

```
> port 1 100F
%Set Port 1 Force speed 100 Full duplex OK !!!
```

### Telnet Command: portmaptime

This command allows you to set a time of keeping the session connection for specified protocol.

#### Syntax

portmaptime [-<command> <parameter> | ... ]



## Syntax Description

| Parameter                                          | Description                                                                                                                     |
|----------------------------------------------------|---------------------------------------------------------------------------------------------------------------------------------|
| <i>[&lt;command&gt;<br/>&lt;parameter&gt; ...]</i> | The available commands with parameters are listed below.<br><i>[...]</i> means that you can Enter several commands in one line. |
| <i>-t &lt;sec&gt;</i>                              | It means "TCP" protocol.<br><sec>: Type a number to set the TCP session timeout.                                                |
| <i>-u &lt;sec&gt;</i>                              | It means "UDP" protocol.<br><sec>: Type a number to set the UDP session timeout.                                                |
| <i>-i &lt;sec&gt;</i>                              | It means "IGMP" protocol.<br><sec>: Type a number to set the IGMP session timeout.                                              |
| <i>-w &lt;sec&gt;</i>                              | It means "TCP WWW" protocol.<br><sec>: Type a number to set the TCP WWW session timeout.                                        |
| <i>-s &lt;sec&gt;</i>                              | It means "TCP SYN" protocol.<br><sec>: Type a number to set the TCP SYN session timeout.                                        |
| <i>-f</i>                                          | It means to flush all portmaps (useful for diagnostics).                                                                        |
| <i>-l &lt;List&gt;</i>                             | List all settings.                                                                                                              |

## Example

```
> portmuptime -t 86400 -u 300 -i 10
> portmuptime -l
----- Current setting -----
TCP Timeout      : 86400 sec.
UDP Timeout      : 300 sec.
IGMP Timeout     : 10 sec.
TCP WWW Timeout  : 60 sec.
TCP SYN Timeout  : 60 sec.
```

## Telnet Command: ppa

This command allows you to configure PPA mode.

**ppa** [*-<command>* *<parameter>* | ... ]

**ppa n** [*-<command>* *<parameter>* | ... ]

## Syntax Description

| Parameter                                          | Description                                                                                                                     |
|----------------------------------------------------|---------------------------------------------------------------------------------------------------------------------------------|
| <i>[&lt;command&gt;<br/>&lt;parameter&gt; ...]</i> | The available commands with parameters are listed below.<br><i>[...]</i> means that you can Enter several commands in one line. |
| <i>-z &lt;1/0&gt;</i>                              | Enable or disable the PPA hardware acceleration.<br>1: Enable; 0: Disable                                                       |
| <i>-m &lt;mode&gt;</i>                             | Specify a mode.<br>1=auto<br>2=manual(traffic)<br>3=manual(qos)<br>0=disable                                                    |
| <i>-p &lt;proto&gt;</i>                            | Specify a protocol.<br>proto - 1-TCP; 2-UDP; 3-Both.                                                                            |
| <i>-b 1/0</i>                                      | Enable/disable TWO-way hardware acceleration.                                                                                   |
| <i>-M enable/disable</i>                           | Enable/disable the multicast hardware acceleration.                                                                             |

|                                             |                                                                                                                                                                                                                       |
|---------------------------------------------|-----------------------------------------------------------------------------------------------------------------------------------------------------------------------------------------------------------------------|
| -S                                          | Show multicast table in HW acceleration                                                                                                                                                                               |
| -I <1/0>                                    | Enable or disable IPSec HW acceleration.<br>1: Enable; 0: Disable                                                                                                                                                     |
| -I -T <1/0>                                 | Enable or disable Protocol TCP for IPSec HW acceleration.<br>1: Enable; 0: Disable                                                                                                                                    |
| -I -U <1/0>                                 | Enable or disable Protocol UDP for IPSec HW acceleration.<br>1: Enable; 0: Disable                                                                                                                                    |
| -V                                          | Show PPA_WAN_Table and PPA_LAN_Table for reference.                                                                                                                                                                   |
| -C                                          | Clean all settings.                                                                                                                                                                                                   |
| -X                                          | Show hardware acceleration information.                                                                                                                                                                               |
| -K                                          | Clean the PPA table.                                                                                                                                                                                                  |
| <b>ppa n - used in QoS or specific host</b> |                                                                                                                                                                                                                       |
| -l <rule>                                   | Specify an index number of rule profile for QoS mode.                                                                                                                                                                 |
| -E -e <1/0>                                 | Enable/disable the exception list.<br>1: Enable; 0: Disable                                                                                                                                                           |
| -E -a <mac> <type>                          | Add exception client.<br><type> : nat ipsec                                                                                                                                                                           |
| -E -u <index> <option> <value>              | Update the information of that exception client.<br>-m <mac> : Enter MAC address.<br>-t <type> : nat ipsec.<br>-d <description>: Enter a brief description.<br>example: -m 12:34:56:78:90:00 -t nat ipsec -d notebook |
| -E -d -i <value>                            | Delete the exception client by specifying an index number.                                                                                                                                                            |
| -E -d -m <value>                            | Delete the exception client by specifying a mac address.                                                                                                                                                              |
| -E -c                                       | Clear exception list.                                                                                                                                                                                                 |
| -E -v                                       | Display the exception list.                                                                                                                                                                                           |

## Example

```

> ppa n -E -e 1
> ppa n -E -a 12:34:56:78:90:00 nat|ipsec
> ppa n -E -u 12:34:56:78:90:00 -t nat|ipsec -d notebook
> ppa n -E -v
> ppa -v
%PPA is enabled
%PPA NAT is enabled
%PPA mode is Auto
%PPA Protocol TCP 1, UDP 0
%PPA Multicast is enabled
%PPA IPSec is disabled
%PPA IPSec Protocol TCP disabled
%PPA IPSec Protocol UDP disabled
%PPA two way enable
%PPA time is 10
%PPA range is 8000
%PAE range is 2048
%MPE range is 5952
%PPA LAN entries 0, working 0
%PPA WAN entries 0, working 0
%PPA statistics interval: 5 sec
>

```

## Telnet Command: hwaccswap

Due to the limitation of the sessions accelerated by the Vigor router, this command allows you to exchange the packets session based on the priority of the sessions (rules defined in Bandwidth Management>>Quality of Service) to ensure the sessions with higher priority will be delivered early.

### Syntax

hwaccswap status

hwaccswap sessnum <1 ~ 60000>

hwaccswap threshold <xxM/xxK/xx>

hwaccswap timer cycle <xxx>/ duration <xxx>/ block <xxx>

### Syntax Description

| Parameter                     | Description                                                                                                              |
|-------------------------------|--------------------------------------------------------------------------------------------------------------------------|
| <i>status</i>                 | Displays current settings for hardware acceleration swap.                                                                |
| <i>sesnum</i> <1 ~ 60000>     | Set a valid session number. When the packet sessions reach the number defined here, the swap function will be activated. |
| <i>threshold</i> <xxM/xxK/xx> | Set a traffic threshold. The unit can be MB, KB and bytes.                                                               |
| <i>timer cycle</i> <xxx>      | Set a cycle time to repeat the sessions swap.<br><xxx> - Enter a time value. The unit is sec.                            |
| <i>timer duration</i> <xxx>   | Set a duration to perform the sessions swap.<br><xxx> - Enter a time value. The unit is sec.                             |
| <i>timer block</i> <xxx>      | Set a time to block the sessions swap.<br><xxx> - Enter a time value. The unit is sec.                                   |

### Example

```
> hwaccswap sessnum 5000
Set max_swap_sess_num: 5000

> hwaccswap status
HW acc session swap related settings:
swap_cycle_timer: 1200 ticks
stat_duration_timer: 0 ticks
swap_block_time: 0 tick
traffic_threshold: 3000 bytes
max_swap_sess_num: 5000

group_map_method:
Group 0: Always In
Group 1: Sort traffic and swap
Group 2: Sort traffic and swap
Group 3: In Once
Group 4: Always In
>
```

## Telnet Command: prn

This command allows you to view current status (interface and driver) of USB printer.

## Syntax

```
prn status
prn debug
prn enable <0/1>
```

## Syntax Description

| Parameter                 | Description                                                                                   |
|---------------------------|-----------------------------------------------------------------------------------------------|
| <i>enable &lt;0/1&gt;</i> | <i>It means to enable / disable the function of USB printer.<br/>0: disable<br/>1: enable</i> |

## Example

```
> prn status
Interface: USB bus 2.0
Printer: NotReady

> prn debug
conn[0] :
none
conn[1] :
none
conn[2] :
none
conn[3] :
none
LPD_data_total=0

usb_lp_ptr=0
UsbPrintReady=0, UsbIsPrinting=0
```

## Telnet Command: qos setup

This command allows user to set general settings for QoS.

## Syntax

```
qos setup [-<command> <parameter> | ... ]
```

## Syntax Description

| Parameter                                          | Description                                                                                                                                              |
|----------------------------------------------------|----------------------------------------------------------------------------------------------------------------------------------------------------------|
| <i>[&lt;command&gt;<br/>&lt;parameter&gt; ...]</i> | The available commands with parameters are listed below.<br><i>[...]</i> means that you can Enter several commands in one line.                          |
| <i>-h</i>                                          | Type it to display the usage of this command.                                                                                                            |
| <i>-W &lt;1~6&gt;</i>                              | It means to select an interface.<br><1~6>: 1 is WAN1; 2 is WAN2 and etc. The default is WAN1.                                                            |
| <i>-m &lt;mode&gt;</i>                             | It means to define which traffic the QoS control settings will apply to and enable QoS control.<br>0: disable.<br>1: in, apply to incoming traffic only. |

|                               |                                                                                                                                                                                                     |
|-------------------------------|-----------------------------------------------------------------------------------------------------------------------------------------------------------------------------------------------------|
|                               | 2: out, apply to outgoing traffic only.<br>3: both, apply to both incoming and outgoing traffic.<br>Default is enable (for outgoing traffic).                                                       |
| <i>-i &lt;bandwidth&gt;</i>   | It means to set inbound bandwidth in kbps (Ethernet WAN only)<br>The available setting is from 1 to 100000.                                                                                         |
| <i>-o &lt;bandwidth&gt;</i>   | It means to set outbound bandwidth in kbps (Ethernet WAN only).<br>The available setting is from 1 to 100000.                                                                                       |
| <i>-r &lt;index:ratio&gt;</i> | It means to set ratio for class index, in %.                                                                                                                                                        |
| <i>-u &lt;mode&gt;</i>        | It means to enable bandwidth control for UDP.<br>0: disable<br>1: enable<br>Default is disable.                                                                                                     |
| <i>-p &lt;ratio&gt;</i>       | It means to enable bandwidth limit ratio for UDP.                                                                                                                                                   |
| <i>-t &lt;mode&gt;</i>        | It means to enable/disable Outbound TCP ACK Prioritize.<br>0: disable<br>1: enable                                                                                                                  |
| <i>-V</i>                     | Show all the settings.                                                                                                                                                                              |
| <i>-I &lt;bandwidth&gt;</i>   | It means the minimum available non-VoIP Inbound Bandwidth when VoIP is detected (Kbps).<br><bandwidth>: Enter a value. Default value: half of WAN inbound bandwidth.                                |
| <i>-O &lt;bandwidth&gt;</i>   | It means the minimum available non-VoIP Outbound Bandwidth when VoIP is detected (Kbps).<br><bandwidth>: Enter a value. Default value: half of WAN outbound bandwidth.                              |
| <i>-v &lt;0/1&gt;</i>         | It means to adjust to minimum In/Out bandwidth setting (or half QoS bandwidth).<br>0: Auto bandwidth adjustment.<br>1: When VoIP detected, QoS In/Out bandwidth will be adjusted to minimum values. |
| <i>-D</i>                     | Set all to factory default (for all WANs).                                                                                                                                                          |

## Example

```
> qos setup -W 2 -m 3 -i 9500 -o 8500 -r 3:20 -u 1 -p 50 -t 1
Setup WAN2 !!!!
WAN2 QoS mode is both
inbound bandwidth set to 9500
outbound bandwidth set to 8500
WAN2 class 3 ratio set to 20
WAN2 udp bandwidth control set to enable
WAN2 udp bandwidth limit ratio set to 50
WAN2 Outbound TCP ACK Prioritizel set to enable
QoS WAN2 set complete; restart QoS
>
```

## Telnet Command: qos class

This command allows user to set QoS class.

### Syntax

```
qos class -c <no> -<a/e/d <no>>[-<command> <parameter> | ... ]
```

## Syntax Description

| Parameter                       | Description                                                                                                                                                                                                                                                                                                                                                                                                                                                                                                                           |
|---------------------------------|---------------------------------------------------------------------------------------------------------------------------------------------------------------------------------------------------------------------------------------------------------------------------------------------------------------------------------------------------------------------------------------------------------------------------------------------------------------------------------------------------------------------------------------|
| [<command><br><parameter>[...]] | The available commands with parameters are listed below.<br>[...] means that you can Enter several commands in one line.                                                                                                                                                                                                                                                                                                                                                                                                              |
| -h                              | Type it to display the usage of this command.                                                                                                                                                                                                                                                                                                                                                                                                                                                                                         |
| -c <no>                         | Specify the inde number for the class.<br>Available value for <no> contains 1, 2 and 3. The default setting is class 1.                                                                                                                                                                                                                                                                                                                                                                                                               |
| -n <name>                       | It means to type a name for the class.                                                                                                                                                                                                                                                                                                                                                                                                                                                                                                |
| -a                              | It means to add rule for specified class.                                                                                                                                                                                                                                                                                                                                                                                                                                                                                             |
| -e <no>                         | It means to edit specified rule.<br><no>: Enter the index number for the rule.                                                                                                                                                                                                                                                                                                                                                                                                                                                        |
| -d <no>                         | It means to delete specified rule.<br><no>: Enter the index number for the rule.                                                                                                                                                                                                                                                                                                                                                                                                                                                      |
| -m <mode>                       | It means to enable or disable the specified rule.<br>0: disable,<br>1: enable                                                                                                                                                                                                                                                                                                                                                                                                                                                         |
| -l <addr>                       | Set the local address.<br><i>Addr1</i> - It means Single address. Please specify the IP address directly, for example, "-l 172.16.3.9".<br><i>addr1:addr2</i> - It means Range address. Please specify the IP addresses, for example, "-l 172.16.3.9: 172.16.3.50."<br><i>addr1:subnet</i> - It means the subnet address with start IP address. Please Enter the subnet and the IP address, for example, "-l 172.16.3.9:255.255.0.0".<br><i>any</i> - It means Any address. Simple type "-" to specify any address for this command.  |
| -r <addr>                       | Set the remote address.<br><i>addr1</i> - It means Single address. Please specify the IP address directly, for example, "-l 172.16.3.9".<br><i>addr1:addr2</i> - It means Range address. Please specify the IP addresses, for example, "-l 172.16.3.9: 172.16.3.50."<br><i>addr1:subnet</i> - It means the subnet address with start IP address. Please Enter the subnet and the IP address, for example, "-l 172.16.3.9:255.255.0.0".<br><i>any</i> - It means Any address. Simple type "-" to specify any address for this command. |
| -l/-r                           | Set the Address Type to "any". No need to input any IP address.                                                                                                                                                                                                                                                                                                                                                                                                                                                                       |
| -p <DSCP id>                    | Specify the ID.                                                                                                                                                                                                                                                                                                                                                                                                                                                                                                                       |
| -s <Service type>               | Specify the predefined service type by typing the number. The available types are listed as below:<br>1:ANY 2:DNS 3:FTP 4:GRE 5:H.323<br>6:HTTP 7:HTTPS 8:IKE 9:IPSEC-AH 10:IPSEC-ESP<br>11:IRC 12:L2TP 13:NEWS 14:NFS 15:NNTP<br>16:PING 17:POP3 18:PPTP 19:REAL-AUDIO 20:RTSP<br>21:SFTP 22:SIP 23:SMTP 24:SNMP 25:SNMP-TRAPS<br>26:SQL-NET 27:SSH 28:SYSLOG 29:TELNET 30:TFTP                                                                                                                                                      |
| -u <Service type>               | Specify the user defined service type by typing the number (1 to 40).                                                                                                                                                                                                                                                                                                                                                                                                                                                                 |
| -S <d/s>                        | Show the content for specified DSCP ID (0 to 20) /Service type (1 to 40).<br>In which, the DSCP ID means;                                                                                                                                                                                                                                                                                                                                                                                                                             |

|                               |                                                                                                                                                                                                                                                                                                                                                                                                                                                                                                          |
|-------------------------------|----------------------------------------------------------------------------------------------------------------------------------------------------------------------------------------------------------------------------------------------------------------------------------------------------------------------------------------------------------------------------------------------------------------------------------------------------------------------------------------------------------|
|                               | 0: default, 1: IP precedence 1, 2: IP precedence 2, 3: IP precedence 3, 4: IP precedence 4, 5: IP precedence 5, 6: IP precedence 6, 7: IP precedence 7, 8: AF Class1 (Low Drop), 9: AF Class1 (Medium Drop), 10: AF Class1 (High Drop), 11: AF Class2 (Low Drop), 12: AF Class2 (Medium Drop) 13: AF Class2 (High Drop), 14: AF Class3 (Low Drop), 15: AF Class3 (Medium Drop), 16: AF Class3 (High Drop) 17: AF Class4 (Low Drop), 18: AF Class4 (Medium Drop), 19: AF Class4 (High Drop), 20: EF Class |
| <code>-V &lt;1/2/3&gt;</code> | Show the rule in the specified class.                                                                                                                                                                                                                                                                                                                                                                                                                                                                    |

### Example

```
> qos class -c 2 -n draytek -a -m 1 -l 192.168.1.50:192.168.1.80

Following setting will set in the class2
class 2 name set to draytek
Add a rule in class2
Class2 the 1 rule enabled
Set local address type to Range, 192.168.1.50:192.168.1.80
>
```

### Telnet Command: qos type

This command allows user to configure protocol type and port number for QoS.

### Syntax

`qos type [-a <service name> | -e <no> | -d <no>].`

### Syntax Description

| Parameter                    | Description                                                                                            |
|------------------------------|--------------------------------------------------------------------------------------------------------|
| <code>-a &lt;name&gt;</code> | It means to add rule.                                                                                  |
| <code>-e &lt;no&gt;</code>   | It means to edit user defined service type. "no" means the index number. Available numbers are 1-40.   |
| <code>-d &lt;no&gt;</code>   | It means to delete user defined service type. "no" means the index number. Available numbers are 1-40. |
| <code>-n &lt;name&gt;</code> | It means the name of the service.                                                                      |
| <code>-t &lt;type&gt;</code> | It means protocol type.<br>6: tcp(default)<br>17: udp<br>0: tcp/udp<br><1-254>: other                  |
| <code>-p &lt;port&gt;</code> | It means service port. The typing format must be [start:end] (ex., 510:330).                           |
| <code>-l</code>              | List user defined types. "no" means the index number. Available numbers are 1-40.                      |

### Example

```
> qos type -a draytek -t 6 -p 510:1330

service name set to draytek
service type set to 6:TCP
```

```

Port type set to Range
Service Port set to 510 ~ 1330
>

```

## Telnet Command: qos voip

This command allows user to enable or disable the QoS for VoIP and RTP.

### Syntax

qos voip <on/off>

### Syntax Description

| Parameter | Description                                                     |
|-----------|-----------------------------------------------------------------|
| on/off    | On - Enable the QoS for VoIP.<br>Off - Disable th QoS for VoIP. |

### Example

```

> qos voip off
QoS for VoIP: Disable; SIP Port: 5060

```

## Telnet Command: hwqos

This command allows user to configure hardware QoS.

### Syntax

hwqos setup [-<command> <parameter> / ... ]

### Syntax Description

| Parameter                         | Description                                                                                                              |
|-----------------------------------|--------------------------------------------------------------------------------------------------------------------------|
| [<command><br><parameter> / ... ] | The available commands with parameters are listed below.<br>[...] means that you can Enter several commands in one line. |
| -W <1/2>                          | Specify the WAN interface.<br><1/2> - 1 means WAN1; 2 means WAN2                                                         |
| -P <1/2/3/4>                      | Specify the LAN interface.<br><1/2/3/4> - 1 means LAN1, 2 means LAN2, and so on                                          |
| -e <1/0>                          | Enable or disable the function.<br><1/0> - 1 means Enable; 0 means Disable                                               |
| -o <bandwidth>                    | Set the bandwidth for outbound traffic (in kbps).<br><bandwidth> - Enter a value (>0).                                   |
| -r <index:ratio>                  | Set the ratio of each class (1 ot 3).<br><index:ratio> - Index range includes 1 to 3; ratio in %.                        |
| -V                                | Display current settings.                                                                                                |
| -D                                | Reset to the factory default settings of hardware QoS.                                                                   |

### Example

```

> hwqos setup -W 2 -e 1 -o 100000 -r 1:60 -r 2:25 -r 3:10
Setup WAN2 !!!!
WAN2 QoS mode is enable
outbound bandwidth set to 100000
Total ratio exceed 100

```



```
>
```

## Telnet Command: quit

This command can exit the telnet command screen.

## Telnet Command: show lan

This command displays current status of LAN IP address settings.

### Example

```
> show lan
The LAN settings:
      ip          mask          dhcp  star_ip          pool  gateway
-----
[V]LAN1  192.168.1.230  255.255.255.0  V   192.168.1.10    200  192.168.1.230
[X]LAN2  192.168.2.1      255.255.255.0  V   192.168.2.10    100  192.168.2.1
[X]LAN3  192.168.3.1      255.255.255.0  V   192.168.3.10    100  192.168.3.1
[X]LAN4  192.168.4.1      255.255.255.0  V   192.168.4.10    100  192.168.4.1
[X]LAN5  192.168.5.1      255.255.255.0  V   192.168.5.10    100  192.168.5.1
[X]LAN6  192.168.6.1      255.255.255.0  V   192.168.6.10    100  192.168.6.1
[X]LAN7  192.168.7.1      255.255.255.0  V   192.168.7.10    100  192.168.7.1
[X]LAN8  192.168.8.1      255.255.255.0  V   192.168.8.10    100  192.168.8.1
[X]Route 192.168.0.1      255.255.255.0  V   0.0.0.0         0    192.168.0.1
>
```

## Telnet Command: show dmz

This command displays current status of DMZ host.

### Example

```
> show dmz
%      WAN1 DMZ mapping status:
Index  Status  WAN1 aux IP    Private IP
-----
1      Disable 0.0.0.0

%      WAN2 DMZ mapping status:
Index  Status  WAN2 aux IP    Private IP
-----
1      Disable 0.0.0.0

%      WAN3 DMZ mapping status:
Index  Status  WAN3 aux IP    Private IP
-----
1      Disable 0.0.0.0

%      WAN4 DMZ mapping status:
Index  Status  WAN4 aux IP    Private IP
-----
1      Disable 0.0.0.0

%      WAN5 DMZ mapping status:
Index  Status  WAN5 aux IP    Private IP
```

```

-----
 1  Disable 0.0.0.0
%   WAN6 DMZ mapping status:
Index Status WAN6 aux IP   Private IP
-----
 1  Disable 0.0.0.0
>

```

### Telnet Command: show dns

This command displays current status of DNS setting

#### Example

```

> show dns
%%   Domain name server settings:
% LAN1 Primary DNS: [Not set]
% LAN1 Secondary DNS: [Not set]

% LAN2 Primary DNS: [Not set]
% LAN2 Secondary DNS: [Not set]

% LAN3 Primary DNS: [Not set]
% LAN3 Secondary DNS: [Not set]

% LAN4 Primary DNS: [Not set]
% LAN4 Secondary DNS: [Not set]

% LAN5 Primary DNS: [Not set]
% LAN5 Secondary DNS: [Not set]
..

```

### Telnet Command: show openport

This command displays current status of open port setting.

#### Example

```

> show openport
%%   Openport settings:
Index Status Comment          Local IP Address
*****
                No data entry.

```

### Telnet Command: show nat

This command displays current status of NAT.

#### Example

```

> show nat
Port Redirection Running Table:

Index Protocol Public Port Private IP Private Port
1         0         0 0.0.0.0         0
2         0         0 0.0.0.0         0

```

|                                                                      |   |   |         |   |
|----------------------------------------------------------------------|---|---|---------|---|
| 3                                                                    | 0 | 0 | 0.0.0.0 | 0 |
| 4                                                                    | 0 | 0 | 0.0.0.0 | 0 |
| 5                                                                    | 0 | 0 | 0.0.0.0 | 0 |
| 6                                                                    | 0 | 0 | 0.0.0.0 | 0 |
| 7                                                                    | 0 | 0 | 0.0.0.0 | 0 |
| 8                                                                    | 0 | 0 | 0.0.0.0 | 0 |
| 9                                                                    | 0 | 0 | 0.0.0.0 | 0 |
| 10                                                                   | 0 | 0 | 0.0.0.0 | 0 |
| 11                                                                   | 0 | 0 | 0.0.0.0 | 0 |
| 12                                                                   | 0 | 0 | 0.0.0.0 | 0 |
| 13                                                                   | 0 | 0 | 0.0.0.0 | 0 |
| 14                                                                   | 0 | 0 | 0.0.0.0 | 0 |
| 15                                                                   | 0 | 0 | 0.0.0.0 | 0 |
| 16                                                                   | 0 | 0 | 0.0.0.0 | 0 |
| 17                                                                   | 0 | 0 | 0.0.0.0 | 0 |
| 18                                                                   | 0 | 0 | 0.0.0.0 | 0 |
| 19                                                                   | 0 | 0 | 0.0.0.0 | 0 |
| 20                                                                   | 0 | 0 | 0.0.0.0 | 0 |
| --- MORE --- ['q': Quit, 'Enter': New Lines, 'Space Bar': Next Page] |   |   |         |   |

### Telnet Command: show portmap

This command displays the table of NAT Active Sessions.

#### Example

```
> show portmap
-----
Private_IP:Port Pseudo_IP:Port Peer_IP:Port [Timeout/Protocol/Flag]
-----
```

### Telnet Command: show pmtime

This command displays the reuse time of NAT session.

Level0: It is the default setting.

Level1: It will be applied when the NAT sessions are smaller than 25% of the default setting.

Level2: It will be applied when the NAT sessions are smaller than the eighth of the default setting.

#### Example

```
> show pmtime
Level0 TCP=86400001 UDP=300001 ICMP=10001
Level1 TCP=600000 UDP=90000 ICMP=7000
Level2 TCP=60000 UDP=30000 ICMP=5000
```

### Telnet Command: show session

This command displays current status of current session.

#### Example

```
> show session
```

```

% Maximum Session Number: 60000
% Maximum Session Usage: 0
% Current Session Usage: 0
% Current Session Used(include waiting for free): 6
% WAN1 Current Session Usage: 0
% WAN2 Current Session Usage: 0
% WAN3 Current Session Usage: 0
% WAN4 Current Session Usage: 0
% WAN5 Current Session Usage: 0
% WAN6 Current Session Usage: 0

```

## Telnet Command: show status

This command displays current status of LAN and WAN connections.

### Example

```

> show status

System Uptime:95:4:44
LAN Status
Primary DNS:8.8.8.8      Secondary DNS:8.8.4.4
IP Address:192.168.1.1  Tx Rate:125096   Rx Rate:41045

WAN 1 Status: Disconnected
Enable:Yes      Line:Ethernet   Name:
Mode:DHCP Client Up Time:0:00:00   IP:---          GW IP:---
TX Packets:0    TX Rate(bps):0   RX Packets:0    RX Rate(bps):0

WAN 2 Status: Disconnected
Enable:Yes      Line:Ethernet   Name:
Mode:DHCP Client Up Time:0:00:00   IP:---          GW IP:---
TX Packets:0    TX Rate(bps):0   RX Packets:0    RX Rate(bps):0

WAN 3 Status: Disconnected
Enable:No       Line:Ethernet   Name:
Mode:---        Up Time:0:00:00   IP:---          GW IP:---
TX Packets:0    TX Rate(bps):0   RX Packets:0    RX Rate(bps):0

WAN 4 Status: Disconnected
Enable:No       Line:Ethernet   Name:
...

```

## Telnet Command: show traffic

This command can display traffic graph for WAN1 to WAN4, transmitted bytes, received bytes and sessions.

### Syntax

```

show traffic [wan1/..wan6] [tx/rx] [weekly]
show traffic [ipaddr] [tx/rx]
show traffic session [weekly]

```



## Telnet Command: show statistic

This command displays statistics for WAN interface.

### Syntax

show statistic

show statistic reset <interface>

### Syntax Description

| Parameter        | Description                                                                                       |
|------------------|---------------------------------------------------------------------------------------------------|
| <i>reset</i>     | It means to reset the transmitted/received bytes to Zero.                                         |
| <i>interface</i> | It means to specify WAN1 -WAN5 (including multi-PVC) interface for displaying related statistics. |

### Example

```
> show statistic
WAN1 total TX: 0 Bytes ,RX: 0 Bytes
WAN2 total TX: 0 Bytes ,RX: 0 Bytes
WAN3 total TX: 0 Bytes ,RX: 0 Bytes
WAN4 total TX: 0 Bytes ,RX: 0 Bytes
WAN5 total TX: 0 Bytes ,RX: 0 Bytes
WAN6 total TX: 0 Bytes ,RX: 0 Bytes
WAN7 total TX: 0 Bytes ,RX: 0 Bytes
WAN8 total TX: 0 Bytes ,RX: 0 Bytes
WAN9 total TX: 0 Bytes ,RX: 0 Bytes
>
```

## Telnet Command: smb setting

This command is used to configure file sharing settings for SMB server.

### Syntax

smb setting <enable/disable>

smb setting status

smb setting set workgroup <Workgroup name>

smb setting set host <host name>

smb setting set access <LAN / LANWAN>

smb setting set version <v1v2/v2>

### Syntax Description

| Parameter                                   | Description                                                            |
|---------------------------------------------|------------------------------------------------------------------------|
| <enable/disable>                            | Enable or disable the SMB service.                                     |
| <i>status</i>                               | Displays current status of SMB service.                                |
| <i>Set workgroup &lt;Workgroup name&gt;</i> | It means to set a name of workgroup for SMB service.                   |
| <i>set host &lt;host name&gt;</i>           | It means to set a name of the host for SMB service.                    |
| <i>set access &lt;LAN / LANWAN&gt;</i>      | It means to set the access into SMB server by LAN or both LAN and WAN. |
| <i>set version &lt;v1v2/v2&gt;</i>          | It means to set SMB server version.                                    |

## Example

```
> smb setting enable
SMB service is enabled.

> smb setting set access LAN
Allow SMB access from LAN only.
> smb setting set version v1v2
SMB version: v1 and v2.
```

## Telnet Command: `srv dhcp dhcp2`

This command is used to enable DHCP2 server.

### Syntax

```
srv dhcp dhcp2 [-<command> <parameter> | ... ]
```

### Syntax Description

| Parameter                      | Description                                                                                                                           |
|--------------------------------|---------------------------------------------------------------------------------------------------------------------------------------|
| <code>-l &lt;enable&gt;</code> | The DHCP server assigns the IP addresses to the clients via LAN port.<br><enable> : Enter 0 (disable) or 1 (enable).                  |
| <code>-m &lt;enable&gt;</code> | The DHCP server assigns the IP addresses to the clients via MAC address configuration.<br><enable> : Enter 0 (disable) or 1 (enable). |
| <code>-e &lt;id&gt;</code>     | Turn on the flag of LAN 1 or LAN 2 if LAN port is enabled.<br><id>: Enter 1 or 2.                                                     |
| <code>-d &lt;id&gt;</code>     | Turn off the flag of LAN port 1 or LAN port 2.<br><id>: Enter 1 or 2.                                                                 |
| <code>-v</code>                | View current status.                                                                                                                  |

## Example

```
> srv dhcp dhcp2 -l 1 -e 1,2
> srv dhcp dhcp2 -v
2nd DHCP server flag status --
  Server works on specified MAC address: ON
  Server works on specified LAN port: ON
  Port 1 flag: ON
  Port 2 flag: ON
>
```

## Telnet Command: `srv dhcp public`

This command allows users to configure DHCP server for second subnet.

### Syntax

```
srv dhcp public start <IP address>
srv dhcp public cnt <IP counts>
srv dhcp public status
srv dhcp public add <MAC Addr XX-XX-XX-XX-XX-XX>
srv dhcp public del <MAC Addr XX-XX-XX-XX-XX-XX/all/ALL>
```

### Syntax Description

| Parameter                                          | Description                                                                                                                                                  |
|----------------------------------------------------|--------------------------------------------------------------------------------------------------------------------------------------------------------------|
| <i>start</i> <IP address>                          | It means the starting point of the IP address pool for the DHCP server.<br><IP address>: Specify an IP address as the starting point in the IP address pool. |
| <i>cnt</i> <IP counts>                             | It means the IP count number.<br><IP counts>: Specify the number of IP addresses in the pool. The maximum is 10.                                             |
| <i>status</i>                                      | It means the execution result of this command.                                                                                                               |
| <i>add</i> <MAC Addr<br>XX-XX-XX-XX-XX-XX>         | It means creating a list of hosts to be assigned.<br><MAC Addr XX-XX-XX-XX-XX-XX>: Specify MAC Address of the host.                                          |
| <i>del</i> <MAC Addr<br>XX-XX-XX-XX-XX-XX/all/ALL> | It means removing the selected MAC address.<br><MAC Addr XX-XX-XX-XX-XX-XX>: Specify MAC Address of the host.<br>all/ALL: It means all of the MAC addresses. |

### Example

```
> ip route add 192.168.1.56 255.255.255.0 192.168.1.12 3 default
> srv dhcp public status
Index   MAC Address
```

## Telnet Command: srv dhcp dns1

This command allows users to set Primary IP Address for DNS Server in LAN.

### Syntax

`srv dhcp dns1 <lan1/lan2/lan3/lan4/lan5/lan6/lan7/lan8> <DNS IP address>`

### Syntax Description

| Parameter                                     | Description                                                                                                                  |
|-----------------------------------------------|------------------------------------------------------------------------------------------------------------------------------|
| <lan1/lan2/lan3/lan4/lan5/<br>lan6/lan7/lan8> | It means to specify the LAN interface for setting the DNS server.                                                            |
| <DNS IP address>                              | It means the IP address that you want to use as DNS1.<br>Note: The IP Routed Subnet DNS must be the same as NAT Subnet DNS). |

### Example

```
> srv dhcp dns1 lan1 168.95.1.1
% srv dhcp dns1 lan1 <DNS IP address>
% Now: 168.95.1.1
(IP Routed Subnet dns same as lan1)
```

## Telnet Command: srv dhcp dns2

This command allows users to set Secondary IP Address for DNS Server in LAN.

### Syntax

`srv dhcp dns2 <lan1/lan2/lan3/lan4/lan5/lan6/lan7/lan8> <DNS IP address>`

### Syntax Description



| Parameter                                 | Description                                                                                                                  |
|-------------------------------------------|------------------------------------------------------------------------------------------------------------------------------|
| <lan1/lan2/lan3/lan4/lan5/lan6/lan7/lan8> | It means to specify the LAN interface for setting the DNS server.                                                            |
| <DNS IP address>                          | It means the IP address that you want to use as DNS2.<br>Note: The IP Routed Subnet DNS must be the same as NAT Subnet DNS). |

### Example

```
> srv dhcp dns2 lan3 10.1.1.1
% srv dhcp dns2 lan3 <DNS IP address>
% Now: 10.1.1.1
```

## Telnet Command: `srv dhcp frcdnsmanl`

This command can force the router to invoke DNS Server IP address.

### Syntax

`srv dhcp frcdnsmanl <on/off>`

### Syntax Description

| Parameter | Description                                      |
|-----------|--------------------------------------------------|
| ?         | It means to display the current status.          |
| on        | It means to use manual setting for DNS setting.  |
| off       | It means to use auto settings acquired from ISP. |

### Example

```
> srv dhcp frcdnsmanl on
% Domain name server now is using manual settings!
> srv dhcp frcdnsmanl off
% Domain name server now is using auto settings!
```

## Telnet Command: `srv dhcp gateway`

This command allows users to specify gateway address for DHCP server.

### Syntax

`srv dhcp gateway <Gateway IP>`

### Syntax Description

| Parameter         | Description                                                 |
|-------------------|-------------------------------------------------------------|
| <i>Gateway IP</i> | It means to specify a gateway address used for DHCP server. |

### Example

```
> srv dhcp gateway 192.168.2.1
This setting will take effect after rebooting.
Please use "sys reboot" command to reboot the router.
```

## Telnet Command: `srv dhcp ipcnt`

This command allows users to specify IP counts for DHCP server.

### Syntax

```
srv dhcp ipcnt <IP counts>
```

### Syntax Description

| Parameter        | Description                                                       |
|------------------|-------------------------------------------------------------------|
| <i>IP counts</i> | It means the number that you have to specify for the DHCP server. |

### Example

```
> srv dhcp ipcnt ?
% srv dhcp ipcnt <IP counts>
% Now: 150
```

## Telnet Command: `srv dhcp off`

This function allows users to turn off DHCP server. It needs rebooting router, please type "sys reboot" command to reboot router.

## Telnet Command: `srv dhcp on`

This function allows users to turn on DHCP server. It needs rebooting router, please type "sys reboot" command to reboot router.

## Telnet Command: `srv dhcp relay`

This command allows users to set DHCP relay setting.

### Syntax

```
srv dhcp relay servip <server ip>
srv dhcp relay 2nd_servip <server ip>
srv dhcp relay subnet <index>
```

### Syntax Description

| Parameter        | Description                                                                                                                     |
|------------------|---------------------------------------------------------------------------------------------------------------------------------|
| <i>server ip</i> | It means the IP address that you want to used as DHCP server.                                                                   |
| <i>Index</i>     | It means subnet 1 or 2. Please type 1 or 2. The router will invoke this function according to the subnet 1 or 2 specified here. |

### Example

```
> srv dhcp relay servip 192.168.1.46
> srv dhcp relay subnet 2
> srv dhcp relay servip ?
% srv dhcp relay servip <server ip>
% Now: 192.168.1.46
```

## Telnet Command: `srv dhcp startip`

### Syntax

`srv dhcp startip <IP address>`

### Syntax Description

| Parameter         | Description                                                                             |
|-------------------|-----------------------------------------------------------------------------------------|
| <i>IP address</i> | It means the IP address that you can specify for the DHCP server as the starting point. |

### Example

```
> srv dhcp startip 192.168.1.53
This setting will take effect after rebooting.
Please use "sys reboot" command to reboot the router.
```

## Telnet Command: `srv dhcp status`

This command can display general information for the DHCP server, such as IP address, MAC address, leased time, host ID and so on.

### Syntax

`srv dhcp status <LAN1/2/3/4/5/6/7/8/ip_routed_subnet>`

### Syntax Description

| Parameter                                          | Description                                                    |
|----------------------------------------------------|----------------------------------------------------------------|
| <i>&lt;LAN1/2/3/4/5/6/7/8/ip_routed_subnet&gt;</i> | It means to display current status for the selected interface. |

### Example

```
> srv dhcp status
LAN1      : DHCP Server On   IP Pool: 192.168.1.10 ~ 192.168.1.209
           Default Gateway: 192.168.1.1
IP Routed : DHCP Server Off
-----
Index  IP Address      MAC Address          Leased Time    HOST ID
-----
LAN1
1      192.168.1.10    00-1D-AA-0F-2E-68   17:24:58
2      192.168.1.11    00-1D-AA-4F-E2-98   17:54:14
>
```

## Telnet Command: `srv dhcp leasetime`

This command can set the lease time for the DHCP server.

### Syntax

`srv dhcp leasetime <Lease Time (sec)>`

### Syntax Description

| Parameter               | Description                                                                               |
|-------------------------|-------------------------------------------------------------------------------------------|
| <i>Lease Time (sec)</i> | It means the lease time (500 to 1661992960) that DHCP server can use. The unit is second. |

### Example

```
> srv dhcp leasetime ?
% srv dhcp leasetime <Lease Time (sec.)>
% Now: 86400
>
```

## Telnet Command: `srv dhcp nodetype`

This command can set the node type for the DHCP server.

### Syntax

`srv dhcp nodetype <count>`

### Syntax Description

| Parameter    | Description                                                                              |
|--------------|------------------------------------------------------------------------------------------|
| <i>count</i> | It means to specify a type for node.<br>1. B-node<br>2. P-node<br>4. M-node<br>8. H-node |

### Example

```
> srv dhcp nodetype 1
> srv dhcp nodetype ?
%% srv dhcp nodetype <count>
%% 1. B-node 2. P-node 4. M-node 8. H-node
% Now: 1
```

## Telnet Command: `srv dhcp primWINS`

This command can set the primary IP address for the DHCP server.

### Syntax

`srv dhcp primWINS <WINS IP address>`

`srv dhcp primWINS clear`

### Syntax Description

| Parameter              | Description                                                        |
|------------------------|--------------------------------------------------------------------|
| <i>WINS IP address</i> | It means the IP address of primary WINS server.                    |
| <i>clear</i>           | It means to remove the IP address settings of primary WINS server. |

### Example

```
> srv dhcp primWINS 192.168.1.88
> srv dhcp primWINS ?
%% srv dhcp primWINS <WINS IP address>
%% srv dhcp primWINS clear
% Now: 192.168.1.88
```

## Telnet Command: `srv dhcp secWINS`

This command can set the secondary IP address for the DHCP server.

### Syntax

`srv dhcp secWINS <WINS IP address>`

`srv dhcp secWINS clear`

### Syntax Description

| Parameter              | Description                                                       |
|------------------------|-------------------------------------------------------------------|
| <i>WINS IP address</i> | It means the IP address of secondary WINS server.                 |
| <i>clear</i>           | It means to remove the IP address settings of second WINS server. |

### Example

```
> srv dhcp secWINS 192.168.1.180
> srv dhcp secWINS ?
%% srv dhcp secWINS <WINS IP address>
%% srv dhcp secWINS clear
% Now: 192.168.1.180
```

## Telnet Command: `srv dhcp expRecycleIP`

This command can set the time to check if the IP address can be assigned again by DHCP server or not.

### Syntax

`srv dhcp expRecycleIP <sec time>`

### Syntax Description

| Parameter       | Description                                                                                   |
|-----------------|-----------------------------------------------------------------------------------------------|
| <i>sec time</i> | It means to set the time (5-300 seconds) for checking if the IP can be assigned again or not. |

### Example

```
Vigor> srv dhcp expRecycleIP 250
% DHCP expired_RecycleIP = 250
```

## Telnet Command: `srv dhcp tftp`

This command can set the TFTP server as the DHCP server.

### Syntax

`srv dhcp tftp <TFTP server name>`

### Syntax Description

| Parameter               | Description                                |
|-------------------------|--------------------------------------------|
| <i>TFTP server name</i> | It means to Enter the name of TFTP server. |

### Example

```
> srv dhcp tftp TF123
> srv dhcp tftp ?
%% srv dhcp tftp <TFTP server name>
% Now: TF123
```

## Telnet Command: `srv dhcp tftpdel`

This command can remove the name defined for the TFTP server.

### Syntax

`srv dhcp tftpdel`

### Example

```
> srv dhcp tftp TF123
> srv dhcp tftp ?
%% srv dhcp tftp <TFTP server name>
% Now: TF123
> srv dhcp tftpdel
% The TFTP Server Name had been deleted !!!
```

## Telnet Command: srv dhcp option

This command can set the custom option for the DHCP server.

### Syntax

srv dhcp option *-h*

srv dhcp option *-l*

srv dhcp option *-d <idx>*

srv dhcp option *-e <1 or 0> -i <lan number> -s <Next Server IP Address>*

srv dhcp option *-e <1 or 0> -i <lan number> -c <option number> -v <option value>*

srv dhcp option *-e <1 or 0> -i <lan number> -c <option number> -x <option value>*

srv dhcp option *-e <1 or 0> -i <lan number> -c <option number> -a <option value>*

srv dhcp option *-u <idx number>*

### Syntax Description

| Parameter                                | Description                                                                                                             |
|------------------------------------------|-------------------------------------------------------------------------------------------------------------------------|
| <i>-h</i>                                | It means to display usage of this command.                                                                              |
| <i>-l</i>                                | It means to display all the user defined DHCP options.                                                                  |
| <i>-d &lt;idx&gt;</i>                    | It means to delete the option number by specifying its index number.                                                    |
| <i>-e &lt;1/0&gt;</i>                    | It means to enable/disable custom option feature.<br>1: Enable; 0: Disable                                              |
| <i>-i &lt;lan number&gt;</i>             | <lan number> : It means to specify the LAN interface.<br>1: lan1<br>a: all LAN<br>r: routed subnet<br>d: DMZ            |
| <i>-s &lt;Next Server IP Address&gt;</i> | It means to set the next server IP address.<br>Next Server IP Address: Enter an IP address.                             |
| <i>-c &lt;option number&gt;</i>          | It means to set option number. Available number ranges from 0 to 255.<br>option number: Enter a number.                 |
| <i>-v &lt;option value&gt;</i>           | It means to set option number by typing string.<br>option value: Enter a string.                                        |
| <i>-x &lt;option value&gt;</i>           | It means to set option number with the format of Hexadecimal characters.<br>option value: Enter a number (hex).         |
| <i>-a &lt;option value&gt;</i>           | It means to set the option value by specifying the IP address.<br>option value: Enter an IP address.                    |
| <i>-u &lt;idx number&gt;</i>             | It means to update the option value of the sepecified index.<br>idx number: Enter the index number of the option value. |
| <i>-r</i>                                | It means to remove all DHCP server options.                                                                             |

### Example

```
> srv dhcp option -e 1 -i 1/2 -s 8.8.8.8
> srv dhcp option -l
% state  idx interface      opt type   data
% enable 1  LAN1/2          0  SIAddr  0.0.0.0
```

## Telnet Command: srv nat dmz

This command allows users to set DMZ host. Before using this command, please set WAN IP Alias first.

### Syntax

srv nat dmz n m [-<command> <parameter> | ... ]

### Syntax Description

| Parameter                      | Description                                                                                                                                                                                                                                                                   |
|--------------------------------|-------------------------------------------------------------------------------------------------------------------------------------------------------------------------------------------------------------------------------------------------------------------------------|
| <i>n</i>                       | It means to map selected WAN IP to certain host.<br>1: wan1<br>2: wan2                                                                                                                                                                                                        |
| <i>m</i>                       | It means the index number (1 to 32) of the DMZ host.<br>Default setting is "1" (WAN 1). It is only available for Static IP mode. If you use other mode, you can set 1 ~ 32 in this field. If WAN IP alias has been configured, then the number of DMZ host can be added more. |
| [<command><br><parameter> ...] | The available commands with parameters are listed below.<br>[...] means that you can Enter several commands in one line.                                                                                                                                                      |
| -e                             | It means to enable/disable such feature.<br>1:enable<br>0:disable                                                                                                                                                                                                             |
| -i                             | It means to specify the private IP address of the DMZ host.                                                                                                                                                                                                                   |
| -r                             | It means to remove DMZ host setting.                                                                                                                                                                                                                                          |
| -v                             | It means to display current status.                                                                                                                                                                                                                                           |

### Example

```
> srv nat dmz 1 1 -i 192.168.1.96
> srv nat dmz -v
%      WAN1 DMZ mapping status:
Index  Status  WAN1 aux IP    Private IP
-----
      1   Disable  0.0.0.0 192.168.1.96

%      WAN2 DMZ mapping status:
Index  Status  WAN2 aux IP    Private IP
-----
      1   Disable  0.0.0.0

%      WAN3 DMZ mapping status:
Index  Status  WAN3 aux IP    Private IP
-----
      1   Disable  0.0.0.0

%      WAN4 DMZ mapping status:
Index  Status  WAN4 aux IP    Private IP
-----
      1   Disable  0.0.0.0
```



```

%      WAN5 DMZ mapping status:
Index  Status  WAN5 aux IP    Private IP
-----
      1   Disable 0.0.0.0

%      WAN6 DMZ mapping status:
Index  Status  WAN6 aux IP    Private IP
-----

      1   Disable 0.0.0.0
>

```

## Telnet Command: `srv nat ipsecpass`

This command allows users to enable or disable IPSec ESP tunnel passthrough and IKE source port (500) preservation.

### Syntax

`srv nat ipsecpass <options>`

### Syntax Description

| Parameter                    | Description                                                                              |
|------------------------------|------------------------------------------------------------------------------------------|
| <code>&lt;options&gt;</code> | The available commands with parameters are listed below.                                 |
| <code>on</code>              | It means to enable IPSec ESP tunnel passthrough and IKE source port (500) preservation.  |
| <code>off</code>             | It means to disable IPSec ESP tunnel passthrough and IKE source port (500) preservation. |
| <code>status</code>          | It means to display current status for checking.                                         |

### Example

```

> srv nat ipsecpass status
%% Status: IPsec ESP pass-thru and IKE src_port:500 preservation is OFF.

```

## Telnet Command: `srv nat openport`

This command allows users to set open port settings for NAT server.

### Syntax

`srv nat openport n m [-<command> <parameter> | ... ]`

### Syntax Description

| Parameter                                                | Description                                                                                                           |
|----------------------------------------------------------|-----------------------------------------------------------------------------------------------------------------------|
| <code>n</code>                                           | It means the index number for the profiles. The range is from 1 to 40.                                                |
| <code>m</code>                                           | It means to specify the sub-item number for this profile. The range is from 1 to 10.                                  |
| <code>[-&lt;command&gt; &lt;parameter&gt;   ... ]</code> | The available commands with parameters are listed below. [...] means that you can Enter several commands in one line. |
| <code>-a &lt;enable&gt;</code>                           | It means to enable or disable the open port rule profile.<br>0: disable<br>1:enable                                   |

|                                           |                                                                                                                                                             |
|-------------------------------------------|-------------------------------------------------------------------------------------------------------------------------------------------------------------|
| <code>-c &lt;comment&gt;</code>           | It means to Enter the description (less than 23 characters) for the defined network service.                                                                |
| <code>-l &lt;source ip idx&gt;</code>     | It means to set source IP object.<br>1 to 192: for IP object<br>1 to 32: for IP group<br>0: Any<br>For example: <code>srv nat openport 1 1 -l 1 -g 0</code> |
| <code>-g &lt;source ip type&gt;</code>    | It means to set IP type.<br>0: IP object<br>1: IP group<br>For example: <code>srv nat openport 1 1 -l 1 -g 0</code>                                         |
| <code>-i &lt;local ip&gt;</code>          | It means to set the IP address for local computer.<br>Local ip: Type an IP address in this field.                                                           |
| <code>-w &lt;widx&gt;&lt;ipidx&gt;</code> | widx: Specify the public IP.<br>1: WAN1 Default,<br>2: WAN1 Alias 1,<br>...and so on.<br>ipidx: Specify the index number of an alias IP (1 to 32).          |
| <code>-p &lt;protocol&gt;</code>          | Specify the transport layer protocol.<br>Available values are TCP, UDP and ALL.                                                                             |
| <code>-s&lt;start port&gt;</code>         | It means to specify the starting port number of the service offered by the local host. The range is from 0 to 65535.                                        |
| <code>-e&lt;end port&gt;</code>           | It means to specify the ending port number of the service offered by the local host.<br>The range is from 0 to 65535.                                       |
| <code>-v</code>                           | It means to display current settings.                                                                                                                       |
| <code>-r &lt;remove&gt;</code>            | It means to delete the specified open port setting.<br>remove: Enter the index number of the profile.                                                       |
| <code>-f</code>                           | It means to return to factory settings for all the open ports profiles.                                                                                     |

## Example

```

> srv nat openport 1 1 -a 1 -c games -i 192.168.1.55 -w 1 1 -p TCP -s 56 -e
83
Set WAN Port ok!!

> srv nat openport 1 1 -v
%% Status: Enable
%% Comment: games
%% WAN Interface: WAN1
%% Private IP address: 192.168.1.55
Index  Protocol      Start Port      End Port
*****
  1.    TCP          56              83
> srv nat openport 1 1 -f
> srv nat openport 1 1 -v
%% Status: Disable
%% Comment:
%% WAN Interface: WAN1
%% Private IP address: 0.0.0.0
Index  Protocol      Start Port      End Port

```

```
*****
>
```

## Telnet Command: `srv nat portmap`

This command allows users to set port redirection table for NAT server.

### Syntax

```

srv nat portmap add <idx> <serv name> <proto> <pub port> <src ip type> <src ip idx> <pri ip>
<pri port> <wan idx> <alias IP>
srv nat portmap del <idx>
srv nat portmap disable <idx>
srv nat portmap enable <idx><proto>
srv nat portmap flush
srv nat portmap table
srv nat portmap view

```

### Syntax Description

| Parameter                        | Description                                                                                                                                                       |
|----------------------------------|-------------------------------------------------------------------------------------------------------------------------------------------------------------------|
| <code>add &lt;idx&gt;</code>     | It means to add a new port redirection table with an index number. Available index number is from 1 to 40.                                                        |
| <code>&lt;serv name&gt;</code>   | It means to type one name as service name.                                                                                                                        |
| <code>&lt;proto&gt;</code>       | It means to specify TCP or UDP as the protocol.                                                                                                                   |
| <code>&lt;pub port&gt;</code>    | It means to specify which port (0 to 65535) can be redirected to the specified Private IP and Port of the internal host.                                          |
| <code>&lt;src ip type&gt;</code> | It means to specify the IP type (object or group).<br>ip type: 0 means IP object; 1 means IP group.                                                               |
| <code>&lt;src ip idx&gt;</code>  | It means to specify the index number of the object profile.<br>ip idx: 1 to 192 for IP object profile; 1 to 32 for IP group profile. 0 means any object or group. |
| <code>&lt;pri ip&gt;</code>      | It means to specify the private IP address of the internal host providing the service.                                                                            |
| <code>&lt;pri port&gt;</code>    | It means to specify the private port number (0 to 65535) of the service offered by the internal host.                                                             |
| <code>&lt;wan idx&gt;</code>     | It means to specify WAN interface for the port redirection.<br>Idx: wan1 to wan6, all                                                                             |
| <code>&lt;alias IP&gt;</code>    | It means to specify an alias IP by entering the index number (1 to 32).<br>ip: 1 to 32.                                                                           |
| <code>del &lt;idx&gt;</code>     | It means to remove the selected port redirection setting.                                                                                                         |
| <code>disable &lt;idx&gt;</code> | It means to inactivate the selected port redirection setting.                                                                                                     |
| <code>enable &lt;idx&gt;</code>  | It means to activate the selected port redirection setting.                                                                                                       |
| <code>flush</code>               | It means to clear all the port mapping settings.                                                                                                                  |
| <code>table</code>               | It means to display Port Redirection Configuration Table.                                                                                                         |

### Example

```

> srv nat portmap add 1 name tcp 100 0 0 192.168.1.10 200 wan1 1
> srv nat portmap table

```

NAT Port Redirection Configuration Table:

| Index | Service Name | Protocol | Public Port | Private IP   |
|-------|--------------|----------|-------------|--------------|
| 1     | name         | TCP      | 100         | 192.168.1.10 |
| 0     | -1           |          |             | 20           |
| 2     |              | Disabled | 0           |              |
| 0     | -2           |          |             |              |
| 3     |              | Disabled | 0           |              |
| 0     | -2           |          |             |              |
| 4     |              | Disabled | 0           |              |
| 0     | -2           |          |             |              |
| 5     |              | Disabled | 0           |              |
| 0     | -2           |          |             |              |
| 6     |              | Disabled | 0           |              |
| 0     | -2           |          |             |              |
| 7     |              | Disabled | 0           |              |
| 0     | -2           |          |             |              |
| 8     |              | Disabled | 0           |              |
| 0     | -2           |          |             |              |
| 9     |              | Disabled | 0           |              |
| 0     | -2           |          |             |              |
| 10    |              | Disabled | 0           |              |
| 0     | -2           |          |             |              |
| 11    |              | Disabled | 0           |              |
| 0     | -2           |          |             |              |
| ...   |              |          |             |              |

## Telnet Command: `srv nat trigger`

This command allows users to configure port triggering settings for NAT.

### Syntax

`srv nat trigger setdefault`

`srv nat trigger view`

`srv nat trigger n [-<command> <parameter> | ... ]`

### Syntax Description

| Parameter                                                            | Description                                                                                                                                              |
|----------------------------------------------------------------------|----------------------------------------------------------------------------------------------------------------------------------------------------------|
| <code>setdefault</code>                                              | Set to factory default settings.                                                                                                                         |
| <code>view</code>                                                    | Display all of the port triggering settings.                                                                                                             |
| <code>n</code><br><code>&lt;command&gt;&lt;parameter&gt;[...]</code> | “n” means the rule number.<br>The available commands with parameters are listed below.<br>[...] means that you can type in several commands in one line. |
| <code>-c &lt;XXX&gt;</code>                                          | Type a comment for such rule if required.                                                                                                                |
| <code>-e &lt;0/1&gt;</code>                                          | Enable (1) or disable (0) a rule (specified with rule number).                                                                                           |
| <code>-s &lt;value&gt;</code>                                        | It means the index number for the source IP.<br><value> - Any, IP Object (0 to 191); IP Group (0 to 31).                                                 |

|                               |                                                                                       |
|-------------------------------|---------------------------------------------------------------------------------------|
| <code>-g &lt;0/1&gt;</code>   | It means the source IP type.<br>0 - IP Object; 1 - IP Group.                          |
| <code>-p &lt;1/2/3&gt;</code> | Specify the protocol for such trigger rule.<br>1 - TCP<br>2 - UDP<br>3 - All          |
| <code>-t</code>               | Specify the port number (0-65535) for trigger.                                        |
| <code>-P &lt;1/2/3&gt;</code> | Specify the incoming protocol for such trigger rule.<br>1 - TCP<br>2 - UDP<br>3 - All |
| <code>-i</code>               | Specify the port number (0-65535) for incoming protocol.                              |
| <code>-d</code>               | Delete the selected trigger rule.                                                     |
| <code>-v</code>               | Display the port trigger settings for specified rule.                                 |

### Example

```
> srv nat trigger 1 -c after_dinner
> srv nat trigger 1 -e 1
> srv nat trigger 1 -p 1
> srv nat trigger 1 -t 2000
> srv nat trigger 1 -P 2
> srv nat trigger 1 -i 3000
> srv nat trigger 1 -v
```

Port Trigger Rule Index:1

```
Status:Enable
Comment:after_dinner2000
Triggering Protocol:TCP
Triggering Port:2000
Incoming Protocol:UDP
Incoming Port:3000
```

### Telnet Command: `srv nat status`

This command allows users to view NAT Port Redirection Running Table.

### Example

```
> srv nat status
NAT Port Redirection Running Table:
```

| Index | Protocol | Public Port | Private IP   | Private Port |
|-------|----------|-------------|--------------|--------------|
| 1     | 6        | 80          | 192.168.1.11 | 100          |
| 2     | 0        | 0           | 0.0.0.0      | 0            |
| 3     | 0        | 0           | 0.0.0.0      | 0            |
| 4     | 0        | 0           | 0.0.0.0      | 0            |
| 5     | 0        | 0           | 0.0.0.0      | 0            |
| 6     | 0        | 0           | 0.0.0.0      | 0            |
| 7     | 0        | 0           | 0.0.0.0      | 0            |

|    |   |   |         |   |
|----|---|---|---------|---|
| 8  | 0 | 0 | 0.0.0.0 | 0 |
| 9  | 0 | 0 | 0.0.0.0 | 0 |
| 10 | 0 | 0 | 0.0.0.0 | 0 |
| 11 | 0 | 0 | 0.0.0.0 | 0 |
| 12 | 0 | 0 | 0.0.0.0 | 0 |
| 13 | 0 | 0 | 0.0.0.0 | 0 |
| 14 | 0 | 0 | 0.0.0.0 | 0 |
| 15 | 0 | 0 | 0.0.0.0 | 0 |
| 16 | 0 | 0 | 0.0.0.0 | 0 |
| 17 | 0 | 0 | 0.0.0.0 | 0 |
| 18 | 0 | 0 | 0.0.0.0 | 0 |
| 19 | 0 | 0 | 0.0.0.0 | 0 |
| 20 | 0 | 0 | 0.0.0.0 | 0 |

--- MORE --- ['q': Quit, 'Enter': New Lines, 'Space Bar': Next Page] ---

### Telnet Command: `srv nat showall`

This command allows users to view a summary of NAT port redirection setting, open port and DMZ settings.

#### Example

```
> srv nat showall ?
Index  Proto  WAN IP:Port          Private IP:Port    Act
*****
R01    TCP    0.0.0.0:100      192.168.1.10:200  Y
O01    TCP    0.0.0.0:56~83    192.168.1.55:56~83 Y
D01    All    0.0.0.0          192.168.1.96     Y

R:Port Redirection, O:Open Ports, D:DMZ
>
```

### Telnet Command: `srv nat pseudoctl`

This command allows users to check the pseudo port number to prevent from port conflict.

#### Syntax

`srv nat pseudoctl session <value>`

`srv nat pseudoctl function <0-3>`

#### Syntax Description

| Parameter                          | Description                                                                                                                                                                                                                                                                                                                                                      |
|------------------------------------|------------------------------------------------------------------------------------------------------------------------------------------------------------------------------------------------------------------------------------------------------------------------------------------------------------------------------------------------------------------|
| <code>session &lt;value&gt;</code> | Set the threshold of the session.<br><value>: 0 to 2147483647.                                                                                                                                                                                                                                                                                                   |
| <code>function &lt;0-3&gt;</code>  | 0: It means "Auto". Check the created pseudo port number automatically when the session number is over the threshold.<br>1: It means "Not". Create a pseudo port number based on subnet setting. No verification.<br>2: It means "Must". Check the created pseudo port number if it is used by other client.<br>3: Create a pseudo port number. No verification. |

## Example

```
> srv nat pseudoctl function 2
pseudo port: get hash pseudo port + subnet.
pseudo port search: check pseudo port(Must).

> srv nat pseudoctl function 3
pseudo port: get hash pseudo port.

> srv nat pseudoctl function 0
pseudo port: get hash pseudo port + subnet.
pseudo port search: check pseudo port(Auto).
```

## Telnet Command: srv nat RSTTimeout

This command is used for forwarding RST out via TCP after a period of time.

### Syntax

srv nat RSTTimeout <value>

### Syntax Description

| Parameter | Description                                                      |
|-----------|------------------------------------------------------------------|
| <value>   | Set the timeout value.<br><value>: 0 to 10 (one unit is 10msec). |

## Example

```
> srv nat RSTTimeout 2
Set timeout 2 unit

> srv nat RSTTimeout ?
%% srv RSTtimeout <value> (unit is 10msec). (0<=value<=10)
-----
now timeout set 2 unit

>
```

## Telnet Command: switch -i

This command is used to obtain the TX (transmitted) or RX (received) data for each connected switch.

### Syntax

switch -i <switch idx\_no><option>

### Syntax Description

| Parameter            | Description                                                                          |
|----------------------|--------------------------------------------------------------------------------------|
| <i>switch idx_no</i> | It means the index number (1 to 8) of the switch profile.                            |
| <i>option</i>        | The available commands with parameters are listed below.<br><i>cmd</i><br><i>acc</i> |

|                                            |                                                                           |
|--------------------------------------------|---------------------------------------------------------------------------|
|                                            | <i>traffic &lt;on/off/status/tx/rx&gt;</i>                                |
| <i>cmd</i>                                 | It means to send command to the client.                                   |
| <i>acc</i>                                 | It means to set the client authentication account and password.           |
| <i>traffic &lt;on/off/status/tx/rx&gt;</i> | It means to turn on/off or display the data transmission from the client. |

### Example

```
> switch -i 1 traffic on
External Device NO. 1 traffic statistic function is enable
>
```

### Telnet Command: switch status

This command is used to check the status for the auto discovery of external devices.

### Example

```
> switch status
External Device auto discovery status : Disable

No Respond to External Device : Enable
```

### Telnet Command: switch not\_respond

This command is used to detect the external device automatically and display on this page.

### Syntax

```
switch not_respond 0
switch not_respond 1
```

### Syntax Description

| Parameter | Description                                                    |
|-----------|----------------------------------------------------------------|
| <i>0</i>  | Disable the option of "No Respond to External Device packets". |
| <i>1</i>  | Enable the option of "No Respond to External Device packets".  |

### Example

```
> switch not_respond 1
slave not respond!
>
```

### Telnet Command: switch on

This command is used to turn on the auto discovery for external devices.

### Example

```
> switch on
Enable Extrnal Device auto discovery!
```

### Telnet Command: switch off

This command is used to turn off the auto discovery for external devices.



## Example

```
> switch off
Disable External Device auto discovery!
```

## Telnet Command: switch list

This command is used to display the connection status of the switch.

## Example

```
> switch list?
No.      Mac          IP          status  Dur Time  CWMP  ACS_CTL  Mod
el_Name  firmware_version
-----
-----
[1] 00-1d-aa-7c-f5-a4 192.168.1.12 On-Line  01:03:57  -1    -1
VigorAP1060C, VigorAP1060C
[2] 14-49-bc-41-33-f4 192.168.1.11 On-Line  01:03:57  -1    -1
G2121
[3] 14-49-bc-43-e5-79 192.168.1.13 On-Line  01:03:57  -1    -1
G2100
```

## Telnet Command: switch clear

This command is used to reset the switch table and reboot the router.

## Syntax

```
switch clear <idx>
```

## Syntax Description

| Parameter  | Description                                                                             |
|------------|-----------------------------------------------------------------------------------------|
| <i>idx</i> | It means the index number of each item shown on the table.<br>The range is from 1 to 8. |
| <i>-f</i>  | It means to clear all of the data.                                                      |

## Example

```
> switch clear 1
Switch Data clear successful

> switch clear -f
Switch Data clear successful
```

## Telnet Command: switch query

This command is used to enable or disable the switch query.

## Example

```
> switch query on
Extern Device status query is Enable
> switch query off
Extern Device status query is Disable
```

## Telnet Command: switch syslog

This command is used to enable or disable the external device syslog.

### Example

```
> switch syslog on
Extern Device status is Enable
> switch syslog off
Extern Device status is Disable
```

## Telnet Command: sys admin

This command is used for RD engineer to access into test mode of Vigor router.

## Telnet Command: sys adminuser

This command is used to create user account and specify LDAP server. The server will authenticate the local user who wants to access into the web user interface of Vigor router.

### Syntax

`sys adminuser <option>`

`sys adminuser edit <index> username password`

### Syntax Description

| Parameter                                   | Description                                                                                                                                                                                                                    |
|---------------------------------------------|--------------------------------------------------------------------------------------------------------------------------------------------------------------------------------------------------------------------------------|
| <i>option</i>                               | Available options includes:<br>Local <0-1><br>LDAP <0-1><br>edit <INDEX><br>delete <INDEX><br>view <INDEX>                                                                                                                     |
| <i>Local &lt;0-1&gt;</i>                    | 0 - Disable the local user.<br>1 - Enable the local user.                                                                                                                                                                      |
| <i>LDAP &lt;0-1&gt;</i>                     | 0 - Disable the LDAP.<br>1 - Enable the LDAP.                                                                                                                                                                                  |
| <i>edit &lt;INDEX&gt; username password</i> | Edit an existed user account or create a new local user account.<br>[INDEX] - 1 -8. There are eight profiles to be added / edited.<br>Username - Type a new name for local user.<br>Password - Type a password for local user. |
| <i>delete &lt;INDEX&gt;</i>                 | Delete a local user account.                                                                                                                                                                                                   |
| <i>view &lt;INDEX&gt;</i>                   | Show the user account/password detail information.                                                                                                                                                                             |

### Example

```
> sys adminuser Local 1
Local User has enabled!
> sys adminuser LDAP 1
LDAP has enabled!
> sys adminuser edit 1 carrie test123
Updated!
> sys adminuser view 1

Index:1
```

```
User Name:carrie
User Password:
0F1AD8240CF4F7566E75F78B6113E1A8595977BB9A98633C12D8AFBD1F019854
```

## Telnet Command: sys board

This command is used to disable/enable and configure the panel control.

### Syntax

```
sys board button def <on/off>
sys board button wlan <on/off>
sys board led control <on/off>
sys board led sleepMode <on/off>
sys board led sleepMode time <minute>
sys board usb <p1/p2> <on/off>
```

### Syntax Description

| Parameter                                 | Description                                                                                                                                                                                                                                                    |
|-------------------------------------------|----------------------------------------------------------------------------------------------------------------------------------------------------------------------------------------------------------------------------------------------------------------|
| <i>button def &lt;on/off&gt;</i>          | The default reset button will be invalid if turn it off.<br>On - The button is valid.<br>Off - The button is invalid.                                                                                                                                          |
| <i>Button wlan &lt;on/off&gt;</i>         | The wireless button will be invalid if turn it off.<br>On - The button is valid.<br>Off - The button is invalid.                                                                                                                                               |
| <i>led control &lt;on/off&gt;</i>         | All LEDs on the front panel will be invalid if turn it off.<br>On - The LEDs are valid.<br>Off - The LEDs are invalid.                                                                                                                                         |
| <i>led sleepMode &lt;on/off&gt;</i>       | All LEDs on the front panel will be set in sleep mode.<br>On - The sleep mode is on.<br>Off - The sleep mode is off.<br>If the sleep mode is on, push the "wireless button" and the "factory reset button" to turn the LED on (even the buttons are disabled). |
| <i>led sleepMode time &lt;minutes&gt;</i> | After enableing the sleep mode for all LEDs, they will sleep after the minutes configured here.<br>Minutes: Enter the number of the time.                                                                                                                      |
| <i>usb &lt;p1/p2&gt; &lt;on/off&gt;</i>   | The USB port will be invalid if turn it off.<br>On - The port is valid.<br>Off - The port is invalid.                                                                                                                                                          |

### Example

```
> sys board led sleepMode on
LEDs Sleep Mode is on now.

> sys board led sleepMode time 10
Sleep Countdown Time set as 10 minute(s).
Reset the led sleep timer success..
```

## Telnet Command: sys bonjour

This command is used to disable/enable and configure the Bonjour service.

### Syntax

```
sys bonjour [-<command> <parameter> | ... ]
```

## Syntax Description

| Parameter                | Description                                                              |
|--------------------------|--------------------------------------------------------------------------|
| <i>-e &lt;enable&gt;</i> | It is used to disable/enable Bonjour service (0: disable, 1: enable).    |
| <i>-h &lt;enable&gt;</i> | It is used to disable/enable HTTP (web) service (0: disable, 1: enable). |
| <i>-t &lt;enable&gt;</i> | It is used to disable/enable Telnet service (0: disable, 1: enable).     |
| <i>-f &lt;enable&gt;</i> | It is used to disable/enable FTP service (0: disable, 1: enable).        |
| <i>-s &lt;enable&gt;</i> | It is used to disable/enable SSH service (0: disable, 1: enable).        |
| <i>-p &lt;enable&gt;</i> | It is used to disable/enable printer service (0: disable, 1: enable).    |
| <i>-b &lt;enable&gt;</i> | It is used to disable/enable IPv6 (0: disable, 1: enable).               |

## Example

```
> sys Bonjour -s 1
>
```

## Telnet Command: sys cfg

This command resets the router with factory default settings. When a user types this command, all the configuration will be reset to default settings.

## Syntax

sys cfg default

sys cfg status

## Syntax Description

| Parameter      | Description                                             |
|----------------|---------------------------------------------------------|
| <i>default</i> | It means to reset current settings with default values. |
| <i>status</i>  | It means to display current profile version and status. |

## Example

```
> sys cfg status
Profile version: 3.0.0   Status: 1 (0x491e5e6c)
> sys cfg default
>
```

## Telnet Command: sys cmdlog

This command displays the history of the commands that you have typed.

## Example

```
> sys cmdlog
% Commands Log: (The lowest index is the newest !!!)
 [1] sys cmdlog
 [2] sys cmdlog ?
 [3] sys ?
 [4] sys cfg status
 [5] sys cfg ?
```

## Telnet Command: sys ftpd

This command displays current status of FTP server.

### Syntax

```
sys ftpd on  
sys ftpd off
```

### Syntax Description

| Parameter  | Description                                        |
|------------|----------------------------------------------------|
| <i>on</i>  | It means to turn on the FTP server of the system.  |
| <i>off</i> | It means to turn off the FTP server of the system. |

### Example

```
> sys ftpd on  
% sys ftpd turn on !!!
```

## Telnet Command: sys domainname

This command can set and remove the domain name of the system when DHCP mode is selected for WAN.

### Syntax

```
sys domainname <wan1/wan2> <Domain Name Suffix>  
sys domainname <wan1/wan2> clear
```

### Syntax Description

| Parameter                 | Description                                                                                              |
|---------------------------|----------------------------------------------------------------------------------------------------------|
| <i>wan1/wan2</i>          | It means to specify WAN interface for assigning a name for it.                                           |
| <i>Domain Name Suffix</i> | It means the name for the domain of the system. The maximum number of characters that you can set is 39. |
| <i>clear</i>              | It means to remove the domain name of the system.                                                        |

### Example

```
> sys domainname wan1 clever  
> sys domainname wan2 intellegent  
> sys domainname ?  
% sys domainname <wan1/wan2> <Domain Name Suffix (max. 39 characters)>  
% sys domainname <wan1/wan2> clear  
% Now: wan1 == clever, wan2 ==intelligent  
>
```

## Telnet Command: sys iface

This command displays the current interface connection status (UP or Down) with IP address, MAC address and Netmask for the router.

### Example

```
> sys iface  
Interface 0 Ethernet:  
Status: UP  
IP Address: 192.168.1.1            Netmask: 0xFFFFF00 (Private)
```

```

IP Address: 0.0.0.0          Netmask: 0xFFFFFFFF
MAC: 00-50-7F-00-00-00
Interface 4 Ethernet:
Status: DOWN
IP Address: 0.0.0.0          Netmask: 0x00000000
MAC: 00-50-7F-00-00-02
Interface 5 Ethernet:
Status: DOWN
IP Address: 0.0.0.0          Netmask: 0x00000000
MAC: 00-50-7F-00-00-03
Interface 6 Ethernet:
Status: DOWN
IP Address: 0.0.0.0          Netmask: 0x00000000
MAC: 00-50-7F-00-00-04
Interface 7 Ethernet:
Status: DOWN
IP Address: 0.0.0.0          Netmask: 0x00000000
MAC: 00-50-7F-00-00-05
Interface 8 Ethernet:
Status: DOWN
IP Address: 0.0.0.0          Netmask: 0x00000000
MAC: 00-50-7F-00-00-06

Interface 9 Ethernet:
Status: DOWN
IP Address: 0.0.0.0          Netmask: 0x00000000
MAC: 00-50-7F-00-00-07
--- MORE ---  ['q': Quit, 'Enter': New Lines, 'Space Bar': Next Page] ---
>

```

## Telnet Command: sys name

This command can set and remove the name for the router when DHCP mode is selected for WAN.

### Syntax

```

sys name <wan1/wan2> <ASCII string>
sys name <wan1/wan2> clear

```

### Syntax Description

| Parameter    | Description                                                                 |
|--------------|-----------------------------------------------------------------------------|
| <wan1/wan2>  | It means to specify WAN interface for assigning a name for it.              |
| ASCII string | It means the name for router. The maximum character that you can set is 39. |

### Example

```

> sys name wan1 drayrouter
> sys name ?
% sys name <wan1/wan2> <ASCII string (max. 39 characters)>
% sys name <wan1/wan2> clear
% Now: wan1 == drayrouter, wan2 ==

```

*Note: Such name can be used to recognize router's identification in SysLog dialog.*

## Telnet Command: sys passwd

This command allows users to set password for the administrator.

```
sys passwd <old password> <new password>
```

### Syntax Description

| Parameter           | Description                                                                                         |
|---------------------|-----------------------------------------------------------------------------------------------------|
| <i>old password</i> | Enter the old password.                                                                             |
| <i>new password</i> | Enter a string as the new password for administrator. The maximum character that you can set is 83. |

### Example

```
> sys passwd admin admin123
Password change successful !!!
>
```

### Telnet Command: sys reboot

This command allows users to restart the router immediately.

### Example

```
> sys reboot
>
```

### Telnet Command: sys autoreboot

This command allows users to restart the router automatically within a certain time.

### Syntax

```
sys autoreboot <on/off/hour(s)>
```

### Syntax Description

| Parameter     | Description                                                                                                                                               |
|---------------|-----------------------------------------------------------------------------------------------------------------------------------------------------------|
| <i>on/off</i> | On - It means to enable the function of auto-reboot.<br>Off - It means to disable the function of auto-reboot.                                            |
| <i>hours</i>  | It means to set the time schedule for router reboot.<br>For example, if you type "2" in this field, the router will reboot with an interval of two hours. |

### Example

```
> sys autoreboot on
autoreboot is ON
> sys autoreboot 2
autoreboot is ON
autoreboot time is 2 hour(s)
```

### Telnet Command: sys commit

This command allows users to save current settings to FLASH. Usually, current settings will be saved in SRAM. Yet, this command will save the file to FLASH.

### Example

```
> sys commit
```

```
>
```

### Telnet Command: sys tftpd

This command can turn on TFTP server for upgrading the firmware.

#### Example

```
> sys tftpd
% TFTP server enabled !!!
```

### Telnet Command: sys cc

This command can display current country code and wireless region of this device.

#### Example

```
> sys cc
Country Code      : 0x 0 [International]
Wireless Region Code: 0x30
>
```

### Telnet Command: sys version

This command can display current version for the system.

#### Example

```
> sys version
Router Model: Vigor2927Vac   Version: 4.4.0 English
Profile version: 4.0.0      Status: 1 (0x9de81d8f)
Router IP: 192.168.1.1      Netmask: 255.255.255.0
Firmware Build Date/Time: Apr 19 2022 15:48:29
Router Name: DrayTek
Revision: 3075_6ffc5c5 drayos2015_v2927_440
Router serial no: None
>
```

### Telnet Command: sys qrybuf

This command can display the system memory status and leakage list.

#### Example

```
> sys qrybuf
System Memory Status and Leakage List

Buf sk_buff ( 200B), used#: 1647, cached#: 30
Buf KMC4088 (4088B), used#: 0, cached#: 8
Buf KMC2552 (2552B), used#: 1641, cached#: 42
Buf KMC1016 (1016B), used#: 7, cached#: 1
Buf KMC504 ( 504B), used#: 8, cached#: 8
Buf KMC248 ( 248B), used#: 26, cached#: 22
Buf KMC120 ( 120B), used#: 67, cached#: 61
Buf KMC56 ( 56B), used#: 20, cached#: 44
```



```
Buf KMC24 ( 24B), used#: 58, cached#: 70
Dynamic memory: 13107200B; 4573168B used; 190480B/0B in level 1/2 cache.

FLOWTRACK Memory Status
# of free = 12000
# of maximum = 0
# of flowstate = 12000
# of lost by siganture = 0
# of lost by list = 0
```

## Telnet Command: sys pollbuf

This command can turn on or turn off polling buffer for the router.

### Syntax

```
sys pollbuf <on/off>
```

### Syntax Description

| Parameter  | Description                          |
|------------|--------------------------------------|
| <i>on</i>  | It means to turn on pulling buffer.  |
| <i>off</i> | It means to turn off pulling buffer. |

### Example

```
> sys pollbuf on
% Buffer polling is on!

> sys pollbuf off
% Buffer polling is off!
```

## Telnet Command: sys britask

This command can improve triple play quality.

### Syntax

```
sys britask <on/off>
```

### Syntax Description

| Parameter  | Description                                                                |
|------------|----------------------------------------------------------------------------|
| <i>on</i>  | It means to turn on the bridge task for improving the triple play quality. |
| <i>off</i> | It means to turn off the bridge task.                                      |

### Example

```
> sys britask on
% bridge task is ON, now
```

## Telnet Command: sys tr069

This command can set CPE settings for applying in VigorACS.

## Syntax

```

sys tr069 get <parm> <option>
sys tr069 set <parm> <value>
sys tr069 getnoti <parm>
sys tr069 setnoti <parm> <value>
sys tr069 log
sys tr069 debug <on/off>
sys tr069 save
sys tr069 inform <event code>
sys tr069 port <port num>
sys tr069 cert_auth<on/off>
sys tr069 only_standard_parm <on/off>
sys tr069 notify -S
sys tr069 notify -n <on/off>
sys tr069 notify -l <on/off>
sys tr069 notify -c <on/off>
sys tr069 notify -b <on/off>
sys tr069 notify -B "<WAN number> <Medium threshold> <High threshold> <TX Speed>Mb <RX Speed>Mb"

```

## Syntax Description

| Parameter                     | Description                                                                                                                                                                                                                                                                                                             |
|-------------------------------|-------------------------------------------------------------------------------------------------------------------------------------------------------------------------------------------------------------------------------------------------------------------------------------------------------------------------|
| <i>get</i> <parm> <option>    | It means to get parameters for tr-069.<br>option=<nextlevel>: only gets nextlevel for GetParameterNames.                                                                                                                                                                                                                |
| <i>set</i> <parm> <value>     | It means to set parameters for tr-069.                                                                                                                                                                                                                                                                                  |
| <i>getnoti</i> <parm>         | It means to get parameter notification value.                                                                                                                                                                                                                                                                           |
| <i>setnoti</i> <parm> <value> | It means to set parameter notification value.                                                                                                                                                                                                                                                                           |
| <i>log</i>                    | It means to display the TR-069 log.                                                                                                                                                                                                                                                                                     |
| <i>debug</i> <on/off>         | on: turn on the function of sending debug message to syslog.<br>off: turn off the function of sending debug message to syslog.                                                                                                                                                                                          |
| <i>save</i>                   | It means to save the parameters to the flash memory of the router.                                                                                                                                                                                                                                                      |
| <i>Inform</i> <event code>    | It means to inform parameters for tr069 with different event codes.<br>[event code] includes:<br>0-"0 BOOTSTRAP",<br>1-"1 BOOT",<br>2-"2 PERIODIC",<br>3-"3 SCHEDULED",<br>4-"4 VALUE CHANGE",<br>5-"5 KICKED",<br>6-"6 CONNECTION REQUEST",<br>7-"7 TRANSFER COMPLETE",<br>8-"8 DIAGNOSTICS COMPLETE",<br>9-"M Reboot" |
| <i>port</i> <port num>        | It means to change tr069 listen port number.                                                                                                                                                                                                                                                                            |
| <i>cert_auth</i> <on/off>     | on: turn on certificate-based authentication.<br>off: turn off certificate-based authentication.                                                                                                                                                                                                                        |
| <i>only_standard_parm</i>     | It means to turn on or off to exclude all the Vendor-Specific ("X_")                                                                                                                                                                                                                                                    |

|                                                                                                                                               |                                                                                                                                                                                                                                                       |
|-----------------------------------------------------------------------------------------------------------------------------------------------|-------------------------------------------------------------------------------------------------------------------------------------------------------------------------------------------------------------------------------------------------------|
| <code>&lt;on/off&gt;</code>                                                                                                                   | parameters, and only send out standard parameters.                                                                                                                                                                                                    |
| <code>notify -n &lt;on/off&gt;</code>                                                                                                         | It means to set CPE notification settings.<br>It means to / not to record the CPE notify log on the Syslog.<br>on: Record on the Syslog.<br>off: Not record on the Syslog.                                                                            |
| <code>notify -l &lt;on/off&gt;</code>                                                                                                         | It means to / not to record the web login log on the Syslog.<br>on: Record on the Syslog.<br>off: Not record on the Syslog.                                                                                                                           |
| <code>notify -c &lt;on/off&gt;</code>                                                                                                         | It means to / not to record the web changed log on the Syslog.<br>on: Record on the Syslog.<br>off: Not record on the Syslog.                                                                                                                         |
| <code>notify -h &lt;on/off&gt;</code>                                                                                                         | It means to / not to record the high availability log on the Syslog.<br>on: Record on the Syslog.<br>off: Not record on the Syslog.                                                                                                                   |
| <code>notify -b [on/off]</code>                                                                                                               | It means to / not to record the bandwidth utilization log on the Syslog.<br>on: Record on the Syslog.<br>off: Not record on the Syslog.                                                                                                               |
| <code>notify -B "&lt;WAN number&gt;<br/>&lt;Medium threthold&gt; &lt;High<br/>threthold&gt; &lt;TX Speed&gt;Mb<br/>&lt;RX Speed&gt;Mb"</code> | It means to set bandwidth utilization setting.<br><WAN number>: Enter the index number of WAN interface(s).<br><Medium threthold>: Enter a value.<br><High threthold>: Enter a value.<br><TX Speed>Mb: Enter a value.<br><RX Speed>Mb: Enter a value. |
| <code>-S</code>                                                                                                                               | Show the CPE notification settings.                                                                                                                                                                                                                   |

## Example

```
> sys tr069 get Int. nextlevel
Total number of parameter is 24
Total content length of parameter is 915
InternetGatewayDevice.LANDeviceNumberOfEntries
InternetGatewayDevice.WANDeviceNumberOfEntries
InternetGatewayDevice.DeviceInfo.
InternetGatewayDevice.ManagementServer.
InternetGatewayDevice.Time.
InternetGatewayDevice.Layer3Forwarding.
InternetGatewayDevice.LANDevice.
InternetGatewayDevice.WANDevice.
InternetGatewayDevice.Services.
InternetGatewayDevice.X_00507F_InternetAcc.
InternetGatewayDevice.X_00507F_LAN.
InternetGatewayDevice.X_00507F_NAT.
InternetGatewayDevice.X_00507F_Firewall.
InternetGatewayDevice.X_00507F_Bandwidth.
InternetGatewayDevice.X_00507F_Applications.
InternetGatewayDevice.X_00507F_VPN.
InternetGatewayDevice.X_00507F_VoIP.
InternetGatewayDevice.X_00507F_WirelessLAN.
InternetGatewayDevice.X_00507F_System.
InternetGatewayDevice.X_00507F_Status.

InternetGatewayDevice.X_00507F_Diagnostics.
```

```

--- MORE ---  ['q': Quit, 'Enter': New Lines, 'Space Bar': Next Page] ---
..
> sys tr069 notify -B "1 30 60 100 100"
Please enable the bandwidth utilization notify log.
> sys tr069 notify -n on
> sys tr069 notify -b on
Set OK
> sys tr069 notify -B "1 30 60 100 100"
> sys tr069 notify -S
CPE Notify Settings:
CPE Notify           Enable
-Web Login           Disable
-Web Changed         Disable
-High Availability   Disable
-Bandwidth Utilization Enable

      Threshold(%)   Speed(Mb)
WAN1 Med: 0 High: 60 TX: 0 RX: 0
WAN2 Med: 0 High: 0 TX: 0 RX: 0
WAN3 Med: 0 High: 0 TX: 0 RX: 0
WAN4 Med: 0 High: 0 TX: 0 RX: 0
WAN5 Med: 0 High: 0 TX: 0 RX: 0
WAN6 Med: 0 High: 0 TX: 0 RX: 0

```

## Telnet Command: sys alg

This command can enable or disable ALG (Application Layer Gateway) master switch.

### Syntax

sys alg <1/0>

### Syntax Description

| Parameter | Description                            |
|-----------|----------------------------------------|
| 1         | It means to enable ALG master switch.  |
| 0         | It means to disable ALG master switch. |

### Example

```

> sys alg -e 1
Enable ALG

> sys alg
Usage: sys alg <command> <parameter>
-e: enable ALG (0:disable, 1:enable)

Current ALG status
-ALG Master Switch: Enabled

```

## Telnet Command: sys sip\_alg

This command can turn on/off SIP ALG (Application Layer Gateway) for traversal.

### Syntax

sys sip\_alg <command> <parameter>|...

### Syntax Description

| Parameter                                          | Description                                                                                                                       |
|----------------------------------------------------|-----------------------------------------------------------------------------------------------------------------------------------|
| <i>[&lt;command&gt;<br/>&lt;parameter&gt; ...]</i> | The available commands with parameters are listed below.<br><i>[...]</i> means that you can type in several commands in one line. |
| <i>-e &lt;0/1&gt;</i>                              | 0: Disable the function of SIP ALG.<br>1: Enable the function of SIP ALG.                                                         |
| <i>-p &lt;parameter&gt;</i>                        | It means to set the listening port for SIP ALG.<br><parameter> : Ranges from 1 to 65535.                                          |
| <i>-u</i>                                          | It means to enable or disable the listen along UDP path setting.<br>0: Disable<br>1: Enable                                       |
| <i>-t</i>                                          | It means to enable or disable the listen along TCP path setting.<br>0: Disable<br>1: Enable                                       |

### Example

```

> sys sip_alg -e 1
  Enable SIP ALG
> sys sip_alg -p 65535
  Current listening port: 65535
> sys sip_alg ?
Usage: sys sip_alg <command> <parameter>
-e: enable SIP ALG (0:disable, 1:enable)
-p: set your listening port for SIP ALG
-u: enable listen along UDP path (0:disable, 1:enable)
-t: enable listen along TCP path (0:disable, 1:enable)

Current SIP ALG status
-ALG Master Switch: Enabled
-SIP ALG: Enabled
-Listen along UDP path: Yes
-Listen along TCP path: Yes
-Listening Port: 65535
-Max sipalg session num: 512
-Remain sipalg session num: 512

```

### Telnet Command: sys rtsp\_alg

This command can turn on/off RTSP ALG (Application Layer Gateway) for traversal.

#### Syntax

sys rtsp\_alg [*<command>* *<parameter>*|...]

#### Syntax Description

| Parameter                                          | Description                                                                                                                       |
|----------------------------------------------------|-----------------------------------------------------------------------------------------------------------------------------------|
| <i>[&lt;command&gt;<br/>&lt;parameter&gt; ...]</i> | The available commands with parameters are listed below.<br><i>[...]</i> means that you can type in several commands in one line. |
| <i>-e &lt;0/1&gt;</i>                              | 0: Disable the function of RTSP ALG.<br>1: Enable the function of RTSP ALG.                                                       |
| <i>-p &lt;parameter&gt;</i>                        | It means to set the listening port for RTSP ALG.<br><parameter> : Ranges from 1 to 65535.                                         |

|                 |                                                                                             |
|-----------------|---------------------------------------------------------------------------------------------|
| <code>-u</code> | It means to enable or disable the listen along UDP path setting.<br>0: Disable<br>1: Enable |
| <code>-t</code> | It means to enable or disable the listen along TCP path setting.<br>0: Disable<br>1: Enable |
| <code>-v</code> | It displays RTP and RTCP portmap information of RTSP ALG.                                   |

## Example

```

> sys rtsp_alg -e 1
Enable RTSP ALG

> sys rtsp_alg -p 60000
Current listening RTSP Port: 60000

> sys rtsp_alg -v
Current Open PortMap Number of RTSP ALG: 0

> sys rtsp_alg ?
Usage: sys rtsp_alg <command> <parameter>
-e: enable RTSP ALG (0:disable, 1:enable)
-p: set your listening port for RTSP ALG
-u: enable listen along UDP path (0:disable, 1:enable)
-t: enable listen along TCP path (0:disable, 1:enable)
-v: show rtp and rtcp portmap information of RTSP ALG

Current RTSP ALG status
-ALG Master Switch: Enabled
-RTSP ALG: Enabled
-Listen along UDP path: Yes
-Listen along TCP path: Yes
-Listening Port: 60000
-Max RTSP session num: 256
-Remain RTSP session num: 256

```

## Telnet Command: sys license

This command can process the system license.

### Syntax

```

sys license reset_regser
sys license licera
sys license licifno <AUTO/WAN#>
sys license licalias <index>
sys license lic_trigger
sys license licelog
sys lic_https set <0/1>

```

### Syntax Description

| Parameter           | Description                                                         |
|---------------------|---------------------------------------------------------------------|
| <i>reset_regser</i> | It means the license register server setting or register service in |

|                            |                                                                                       |
|----------------------------|---------------------------------------------------------------------------------------|
|                            | portal.                                                                               |
| <i>licera</i>              | It means to erase license setting.                                                    |
| <i>licifno</i> <AUTO/WAN#> | It means license and signature download interface setting.                            |
| <i>licalias</i> <index>    | It means to specify an IP alias by entering the index number of the IP alias profile. |
| <i>lic_trigger</i>         | It means to trigger the license.                                                      |
| <i>licelog</i>             | It means to show the authentication log.                                              |
| <i>lic_https set</i> <0/1> | 0 - Set the lic connect type to HTTP.<br>1 - Set the lic connect type to HTTPs.       |

### Example

```
> sys license licifno wan3
Download interface is set as "WAN3" now.
>
```

## Telnet Command: sys diag\_log

This command is used for RD debug.

### Syntax

*sys diag\_log* <status/ enable/ disable/ flush/ lineno <w> | level <x> | feature <on/off><y>| voip\_feature <on/off> <vf\_name>| log>

### Syntax Description

| Parameter                              | Description                                                                                                                                                                                                                                          |
|----------------------------------------|------------------------------------------------------------------------------------------------------------------------------------------------------------------------------------------------------------------------------------------------------|
| <i>status</i>                          | It means to show the status of diagnostic log.                                                                                                                                                                                                       |
| <i>enable</i>                          | It means to enable the function of diag_log.                                                                                                                                                                                                         |
| <i>disable</i>                         | It means to disenable the function of diag_log.                                                                                                                                                                                                      |
| <i>flush</i>                           | It means the flush log buffer.                                                                                                                                                                                                                       |
| <i>lineno</i> <w>                      | It means the total lines for displaying message.<br>w - Available value ranges from 100 to 50000.                                                                                                                                                    |
| <i>level</i> <x>                       | It determines the level of data displayed.<br>x - Available value ranges from 0 to 12. The larger the number is, the detailed the data is displayed.                                                                                                 |
| <i>feature</i> <on/off> <y>            | It is used to specify the function of the log. Supported features include SYS, VoIP and EthOAM.                                                                                                                                                      |
| <i>voip_feature</i> <on/off> <vf_name> | It means VoIP feature. Type on to enable the feature or type off to disable the feature.<br>vf_name: available settings include DRVTAPI, DRVMMC, DRVMPS, DRVFXO, DRVHAL, PSMPHONE, PSMSUPP, PSM, FXO, PSMISDN, DTMFPSE, CALLERID (Case-Insensitive). |
| <i>log</i>                             | It means the dump log buffer.                                                                                                                                                                                                                        |

### Example

```
> sys diag_log status
Status:
diag_log is Disabled.
lineno : 10000.
level : 3.
```

```

Enabled feature: SYS
> sys diag_log log
0:00:02 [DSL] Current modem firmware: AnnexA_548006_544401
0:00:02 [DSL] Modem firmware feature: 5, ADSL_A, VDSL2
0:00:02 [DSL] xtseCfg=04 00 04 00 0c 01 00 07
0:00:02 [DSL] dont have last showtime mode!! set next mode to VDSL!!
0:00:02 [DSL] Status has changed: Stopped(0) -> FwWait(3)
0:00:02 [DSL] Status has changed: FwWait(3) -> Starting(1)
0:00:02 [DSL] Status has changed: Starting(1) -> Running(2)
0:00:02 [DSL] Status was switched: firmwareReady(3) to Init(5)

```

## Telnet Command: sys arp\_AutoReq

This command is used to enable / disable the function that Vigor router sends ARP request to the connected device(s) periodically.

### Syntax

sys arp\_AutoReq -d <value>

### Syntax Description

| Parameter  | Description                                                            |
|------------|------------------------------------------------------------------------|
| -d [value] | Disable the function of ARP auto request.<br>0 - Enable<br>1 - Disable |

### Example

```

> sys arp_AutoReq -d 1
  Arp auto-request disable.
>

```

## Telnet Command: sys daylightsave

This command is used to configure day light saving.

### Syntax

sys daylightsave [-<command> <parameter> | ... ]

### Syntax Description

| Parameter                         | Description                                                                                                                 |
|-----------------------------------|-----------------------------------------------------------------------------------------------------------------------------|
| [<command><parameter> ... ]       | The available commands with parameters are listed below.<br>[...] means that you can type in several commands in one line.  |
| -v                                | Display the daylight saving settings.                                                                                       |
| -r                                | Set to factory default setting.                                                                                             |
| -e <1/0>                          | Enable (1) / disable (0) daylight saving.                                                                                   |
| -t <0/1/2>                        | Specify the saving type for daylight setting.<br>0 - Default<br>1 - Time range<br>2 - Yearly                                |
| -s <year> <month> <day><br><hour> | Set the detailed settings of the starting day for time range type.<br>year - must be the year after 2013.<br>month - 1 - 12 |



|                                                 |                                                                                                                                                                                                                                              |
|-------------------------------------------------|----------------------------------------------------------------------------------------------------------------------------------------------------------------------------------------------------------------------------------------------|
|                                                 | day - 1 ~ 31<br>hour - 0 ~ 23<br>e.g., sys daylightsave -s 2014 3 10 12                                                                                                                                                                      |
| -d <year> <month> <day><br><hour>               | Set the detailed settings of the ending day for time range type.<br>year - After 2013.<br>month - 1 ~ 12<br>day - 1 ~ 31<br>hour - 0 ~ 23<br>e.g., sys daylightsave -d 2014 9 10 12                                                          |
| -y <month> <th weekday><br><day in week> <hour> | Set the detailed settings of the starting day for yearly type.<br>month - 1 ~ 12<br>th weekday - 1 ~ 5, 9: last week<br>day in week - 0:Sun, 1:Mon, 2:Tue, 3:Wed, 4:Thu, 5: Fri, 6:Sat<br>hour - 0 ~ 23<br>e.g, sys daylightsave -y 9 1 0 14 |
| -z <month> <th weekday><br><day in week> <hour> | Set the detailed settings of the ending day for yearly type.<br>month - 1 ~ 12<br>th weekday - 1 ~ 5, 9: last week<br>day in week - 0:Sun, 1:Mon, 2:Tue, 3:Wed, 4:Thu, 5: Fri, 6:Sat<br>hour - 0 ~ 23<br>e.g, sys daylightsave -z 3 1 6 14   |

### Example

```
> sys daylightsave -y 9 1 0 14
% Start: Yearly on Sep 1th Sun 14:00
```

## Telnet Command: sys dnsCacheTbl

This command is used to configure TTL settings which will be displayed in DNS Cache table.

### Syntax

sys dnsCacheTbl [*<command><parameter>|...*]

### Syntax Description

| Parameter                                                  | Description                                                                                                                |
|------------------------------------------------------------|----------------------------------------------------------------------------------------------------------------------------|
| [ <i>&lt;command&gt;</i><br><i>&lt;parameter&gt; ...</i> ] | The available commands with parameters are listed below.<br>[...] means that you can type in several commands in one line. |
| -l                                                         | It means to show DNS IPv4 entry in DNS cache table.                                                                        |
| -s                                                         | It means to show DNS IPv6 entry in DNS cache table.                                                                        |
| -v                                                         | It means to show TTL limit value in DNS cache table.                                                                       |
| -t <tll>                                                   | It means to set TTL limit value.<br><tll>: 0(no limit) or an number greater than 5.                                        |
| -c                                                         | It means to clear the DNS cache table.                                                                                     |

### Example

```
> sys dnsCacheTbl -t 50
> % Set TTL limit: 50 seconds.
% When TTL larger than 50s , delete the DNS entry in the router's DNS cache
```

```

tabl
e.
> sys dnsCacheTbl -v
% TTL limit: 50 seconds
% When TTL larger than 50s , delete the DNS entry in the router's DNS cache
tabl

```

## Telnet Command: sys syslog

This command is used to configure day light saving.

### Syntax

sys syslog *-a <enable> [-<command> <parameter> | ... ]*

### Syntax Description

| Parameter                                      | Description                                                                                                             |
|------------------------------------------------|-------------------------------------------------------------------------------------------------------------------------|
| <i>[&lt;command&gt;&lt;parameter&gt; ... ]</i> | The available commands with parameters are listed below. [...] means that you can type in several commands in one line. |
| <i>-a &lt;1/0&gt;</i>                          | Enable (1) or disable (0) Syslog Access Setup.                                                                          |
| <i>-s &lt;1/0&gt;</i>                          | Enable (1) or disable (0) Syslog Save to Syslog Server.                                                                 |
| <i>-i &lt;IP address&gt;</i>                   | Define the IP address of the Syslog server.                                                                             |
| <i>-d &lt;port number&gt;</i>                  | Define the port number (1 - 65535) as the destination port.                                                             |
| <i>-u &lt;1/0&gt;</i>                          | Enable (1) or disable (0) Syslog Save to USB Disk.                                                                      |
| <i>-m &lt;1/0&gt;</i>                          | Enable (1) or disable (0) Mail Syslog.                                                                                  |
| <i>-f &lt;1/0&gt;</i>                          | Enable (1) or disable (0) Firewall Log.                                                                                 |
| <i>-v &lt;1/0&gt;</i>                          | Enable (1) or disable (0) VPN Log.                                                                                      |
| <i>-e &lt;1/0&gt;</i>                          | Enable (1) or disable (0) User Access Log.                                                                              |
| <i>-c &lt;1/0&gt;</i>                          | Enable (1) or disable (0) Call Log.                                                                                     |
| <i>-w &lt;1/0&gt;</i>                          | Enable (1) or disable (0) WAN Log.                                                                                      |
| <i>-l &lt;1/0&gt;</i>                          | Enable (1) or disable (0) WLAN Log.                                                                                     |
| <i>-r &lt;1/0&gt;</i>                          | Enable (1) or disable (0) Router/DSL Information.                                                                       |
| <i>-p</i>                                      | Update the server IP address.                                                                                           |
| <i>-W &lt;1/0&gt;</i>                          | Set the mode for writing Syslog.<br>0: overwrite oldest logs; 1: stop logging.                                          |
| <i>-U &lt;1/0&gt;</i>                          | Set the unit for the Syslog saved to a USB disk.<br>0:GB; 1:MB                                                          |
| <i>-S &lt;capacity&gt;</i>                     | Set the folder capacity for the syslog saved in the USB disk.<br>1 -16(GB); 1 -1024(MB)                                 |

### Example

```

> sys syslog -a 1 -s 1 -i 192.168.1.25 -d 514
>

```

## Telnet Command: sys mailalert

This command is used to configure settings for syslog mail alert.

### Syntax

sys mailalert *[-<command> <parameter>]*

## Syntax Description

| Parameter               | Description                                                                                                                                                                                                                                                                                                                                                                                                                                   |
|-------------------------|-----------------------------------------------------------------------------------------------------------------------------------------------------------------------------------------------------------------------------------------------------------------------------------------------------------------------------------------------------------------------------------------------------------------------------------------------|
| [<command><parameter>]  | The available commands with parameters are listed below.                                                                                                                                                                                                                                                                                                                                                                                      |
| -e <0/1>                | Enable/disable Mail Alert.<br>0 - Disable. 1 - Enable.                                                                                                                                                                                                                                                                                                                                                                                        |
| -w <0/1/2/...>          | Set Interface (Physical) Any/WAN1/WAN2/WAN... and etc.                                                                                                                                                                                                                                                                                                                                                                                        |
| -x <WAN IP Alias index> | Set WAN IP Alias. Index 1 is reserved and must set an interface first.                                                                                                                                                                                                                                                                                                                                                                        |
| -i <SMTP Server IP>     | Set IP Address for SMTP server.                                                                                                                                                                                                                                                                                                                                                                                                               |
| -o <SMTP Server Port>   | Set port number for SMTP server..                                                                                                                                                                                                                                                                                                                                                                                                             |
| -a <Mail Address>       | Set E-mail address for alert mail reciver.                                                                                                                                                                                                                                                                                                                                                                                                    |
| -r <Mail Address>       | Set E-mail Address for mail return.                                                                                                                                                                                                                                                                                                                                                                                                           |
| -s <0/1/2/3>            | Set Connection Security<br>0 - Plaintext<br>1 - SSL<br>2 - StartTLS<br>3 - Force StartTLS                                                                                                                                                                                                                                                                                                                                                     |
| -h <0/1>                | Enable/disable SMTP Authentication.<br>0 - Disable. 1 - Enable.                                                                                                                                                                                                                                                                                                                                                                               |
| -u <Username>           | Set username for SMTP Authentication.                                                                                                                                                                                                                                                                                                                                                                                                         |
| -p <Password>           | Set password for SMTP Authentication.                                                                                                                                                                                                                                                                                                                                                                                                         |
| -l <type><0/1>          | Enable / disable mail alert for different types. Number 0 ~ 6 represent different types.<br>"0 <0/1>" : Enable/Disable Mail Alert of the DoS Attack.<br>"1 <0/1>" : Enable/Disable Mail Alert of the APPE.<br>"2 <0/1>" : nable/Disable Mail Alert of the VPN Log.<br>"3 <0/1>" : Enable/Disable Mail Alert of the APPE Signature.<br>"6 <0/1>" : Enable/Disable Mail Alert of the Reboot Debug Log.<br>In which,<br>0 - Disable. 1 - Enable. |
| -f                      | Reset Mail Alert setting to factory default.                                                                                                                                                                                                                                                                                                                                                                                                  |
| -v                      | Show current Mail Alert setting.                                                                                                                                                                                                                                                                                                                                                                                                              |
| -R <0/1>                | Set Mail Alert Reboot debug log mode.<br>0: Limited Mode<br>1: Unlimited Mode.                                                                                                                                                                                                                                                                                                                                                                |

## Example

```
> sys mailalert -e 1
Set Enable Mail Alert.
> sys mailalert -v
----- Current setting for Mail Alert -----
Mail Alert: Enable
SMTP Server IP Address: 0.0.0.0
SMTP Server Port: 25
Alert Mail Reciver E-maiil Address:
Mail Return E-mail Address:
Use SSL: Disable
SMTP Authentication: Disable
Username for SMTP Authentication:
Password for SMTP Authentication:
Mail Alert for DoS Attack: Enable.
```

```

Mail Alert for APPE: Enable.
Mail Alert for VPN Log: Enable.
Mail Alert for APPE Signature: Disable.
Mail Alert for Reboot Debug Log: Disable, Mode: Limited.
-----

```

## Telnet Command: sys time

This command is used to configure system time and date.

### Syntax

`sys time server <domain>`

`sys time inquire`

`sys time show`

`sys time wan <option>`

`sys time zone <index>`

`sys time pseudo`

### Syntax Description

| Parameter                          | Description                                                                                                                                                                                                                                                                                                                                                                                                                                                                                                                                                                                                                                                                                                                                                            |
|------------------------------------|------------------------------------------------------------------------------------------------------------------------------------------------------------------------------------------------------------------------------------------------------------------------------------------------------------------------------------------------------------------------------------------------------------------------------------------------------------------------------------------------------------------------------------------------------------------------------------------------------------------------------------------------------------------------------------------------------------------------------------------------------------------------|
| <code>server &lt;domain&gt;</code> | Enter the domain name of the time server.<br><domain> - The maximum length is 39 characters.                                                                                                                                                                                                                                                                                                                                                                                                                                                                                                                                                                                                                                                                           |
| <code>inquire</code>               | Get the time based on the timer server setting.                                                                                                                                                                                                                                                                                                                                                                                                                                                                                                                                                                                                                                                                                                                        |
| <code>show</code>                  | Displays current server setting.                                                                                                                                                                                                                                                                                                                                                                                                                                                                                                                                                                                                                                                                                                                                       |
| <code>wan &lt;option&gt;</code>    | Set the WAN interface.<br>0 - Auto<br>1 - WAN1<br>2 - WAN2<br>3 - WAN3<br>4 - WAN4<br>5 - WAN5<br>6 - WAN6                                                                                                                                                                                                                                                                                                                                                                                                                                                                                                                                                                                                                                                             |
| <code>zone &lt;index&gt;</code>    | Different number means different time zone.<br>1 - GMT-12:00 Eniwetok, Kwajalein<br>2 - GMT-11:00 Midway Island, Samoa<br>3 - GMT-10:00 Hawaii<br>4 - GMT-09:00 Alaska<br>5 - GMT-08:00 Pacific Time (US & Canada)<br>6 - GMT-08:00 Tijuana<br>7 - GMT-07:00 Mountain Time (US & Canada)<br>8 - GMT-07:00 Arizona<br>9 - GMT-06:00 Central Time (US & Canada)<br>10 - GMT-06:00 Saskatchewan<br>11 - GMT-06:00 Mexico City, Tegucigalpa<br>12 - GMT-05:00 Eastern Time (US & Canada)<br>13 - GMT-05:00 Indiana (East)<br>14 - GMT-05:00 Bogota, Lima, Quito<br>15 - GMT-04:00 Atlantic Time (Canada)<br>16 - GMT-04:00 Caracas, La Paz<br>17 - GMT-04:00 Santiago<br>18 - GMT-03:30 Newfoundland<br>19 - GMT-03:00 Brasilia<br>20 - GMT-03:00 Buenos Aires, Georgetown |

|                                                          |                                                                                                                                                                                                                                                                                                                                                                                                                                                                                                                                                                                                                                                                                                                                                                                                                                                                                                                                                                                                                                                                                                                                                                                                                                                                                                                                                                                                                                                                                                                                                                                                                                                                                                                                                                                                                                                                                                        |
|----------------------------------------------------------|--------------------------------------------------------------------------------------------------------------------------------------------------------------------------------------------------------------------------------------------------------------------------------------------------------------------------------------------------------------------------------------------------------------------------------------------------------------------------------------------------------------------------------------------------------------------------------------------------------------------------------------------------------------------------------------------------------------------------------------------------------------------------------------------------------------------------------------------------------------------------------------------------------------------------------------------------------------------------------------------------------------------------------------------------------------------------------------------------------------------------------------------------------------------------------------------------------------------------------------------------------------------------------------------------------------------------------------------------------------------------------------------------------------------------------------------------------------------------------------------------------------------------------------------------------------------------------------------------------------------------------------------------------------------------------------------------------------------------------------------------------------------------------------------------------------------------------------------------------------------------------------------------------|
|                                                          | 21 - GMT-02:00 Mid-Atlantic<br>22 - GMT-01:00 Azores, Cape Verde Is.<br>23 - GMT Greenwich Mean Time : Dublin<br>24 - GMT Edinburgh, Lisbon, London<br>25 - GMT Casablanca, Monrovia<br>26 - GMT+01:00 Belgrade, Bratislava<br>27 - GMT+01:00 Budapest, Ljubljana, Prague<br>28 - GMT+01:00 Sarajevo, Skopje, Sofija<br>29 - GMT+01:00 Warsaw, Zagreb<br>30 - GMT+01:00 Brussels, Copenhagen<br>31 - GMT+01:00 Madrid, Paris, Vilnius<br>32 - GMT+01:00 Amsterdam, Berlin, Bern<br>33 - GMT+01:00 Rome, Stockholm, Vienna<br>34 - GMT+02:00 Bucharest<br>35 - GMT+02:00 Cairo<br>36 - GMT+02:00 Helsinki, Riga, Tallinn<br>37 - GMT+02:00 Athens, Istanbul, Minsk<br>38 - GMT+02:00 Jerusalem<br>39 - GMT+02:00 Harare, Pretoria<br>40 - GMT+03:00 Volgograd<br>41 - GMT+03:00 Baghdad, Kuwait, Riyadh<br>42 - GMT+03:00 Nairobi<br>43 - GMT+03:00 Moscow, St. Petersburg<br>44 - GMT+03:30 Tehran<br>45 - GMT+04:00 Abu Dhabi, Muscat<br>46 - GMT+04:00 Baku, Tbilisi<br>47 - GMT+04:30 Kabul<br>48 - GMT+05:00 Ekaterinburg<br>49 - GMT+05:00 Islamabad, Karachi, Tashkent<br>50 - GMT+05:30 Bombay, Calcutta<br>51 - GMT+05:30 Madras, New Delhi<br>52 - GMT+06:00 Astana, Almaty, Dhaka<br>53 - GMT+06:00 Colombo<br>54 - GMT+07:00 Bangkok, Hanoi, Jakarta<br>55 - GMT+08:00 Beijing, Chongqing<br>56 - GMT+08:00 Hong Kong, Urumqi<br>57 - GMT+08:00 Singapore<br>58 - GMT+08:00 Taipei<br>59 - GMT+08:00 Perth<br>60 - GMT+09:00 Seoul<br>61 - GMT+09:00 Osaka, Sapporo, Tokyo<br>62 - GMT+09:00 Yakutsk<br>63 - GMT+09:30 Darwin<br>64 - GMT+09:30 Adelaide<br>65 - GMT+10:00 Canberra, Melbourne, Sydney<br>66 - GMT+10:00 Brisbane<br>67 - GMT+10:00 Hobart<br>68 - GMT+10:00 Vladivostok<br>69 - GMT+10:00 Guam, Port Moresby<br>70 - GMT+11:00 Magadan, Solomon Is.<br>71 - GMT+11:00 New Caledonia<br>72 - GMT+12:00 Fiji, Kamchatka, Marshall Is.<br>73 - GMT+12:00 Auckland, Wellington |
| <i>pseudo -E</i> <1/0>                                   | Enable (1) or disable (0) the pseudo system time.                                                                                                                                                                                                                                                                                                                                                                                                                                                                                                                                                                                                                                                                                                                                                                                                                                                                                                                                                                                                                                                                                                                                                                                                                                                                                                                                                                                                                                                                                                                                                                                                                                                                                                                                                                                                                                                      |
| <i>pseudo -T</i> <year> <month><br><day> <hour> <minute> | Set the pseudo time value.<br><year> - Enter four digits.<br><month> - Enter 1 to 12.<br><day> - Enter the day in a month.<br><hour> - Enter the number of the hour (1 to 23).<br><minute> - Enter the number of the minute (1 to 59).                                                                                                                                                                                                                                                                                                                                                                                                                                                                                                                                                                                                                                                                                                                                                                                                                                                                                                                                                                                                                                                                                                                                                                                                                                                                                                                                                                                                                                                                                                                                                                                                                                                                 |

|                        |                              |
|------------------------|------------------------------|
| <code>pseudo -S</code> | Displays pseudo system time. |
|------------------------|------------------------------|

### Example

```

> sys time pseudo -E 1
> sys time zone 8
Set Time Zone OK

> sys time show
***** System Time *****
Current System Time: [2000 Jan 01 Sat 02:40:41]
Time Server: [pool.ntp.org]
Time Zone Index: [8]. GMT-07:00
Send NTP Request Through: Auto
*****
>

```

### Telnet Command: `sys eap_tls`

This command is used to disable or enable EAP-TLS.

You might have to enable EAP-TLS compatibility to avoid compatibility issues with some operating systems. But, please note that enabling EAP-TLS compatibility will lower down the connection security level.

#### Syntax

`sys eap_tls set <0/1>`

#### Syntax Description

| Parameter      | Description                    |
|----------------|--------------------------------|
| <code>0</code> | Disable EAP-TLS compatibility! |
| <code>1</code> | Enable EAP-TLS compatibility!  |

### Example

```

> sys eap_tls set 1
Enable EAP_TLS compatibility!

```

### Telnet Command: `sys dashboard`

This command is used to display / hide items (such as System Information, Interface...) on dashboard.

#### Syntax

`sys dashboard [-<command> <value> | ... ]`

`sys dashboard show`

#### Syntax Description

| Parameter                                         | Description                                                                                                                                                                                                        |
|---------------------------------------------------|--------------------------------------------------------------------------------------------------------------------------------------------------------------------------------------------------------------------|
| <code>[-&lt;command&gt; &lt;value&gt; ...]</code> | The available commands with parameters are listed below. [...] means that you can type in several parameters in one line. <command> “0 ~ 9” and “a” represent different sections to be displayed on the dashboard. |

|             |                                                                                                                                                                                                                                                                              |
|-------------|------------------------------------------------------------------------------------------------------------------------------------------------------------------------------------------------------------------------------------------------------------------------------|
|             | 0 : Front Panel<br>1 : System Information<br>2 : IPv4 LAN Information<br>3 : IPv4 Internet Access<br>4 : IPv6 Internet Access<br>5 : Interface<br>6 : Security<br>7 : System Resource<br>8 : LTE Status<br>9 : Quick Access<br>a : VoIP<br><value> 1 : Enable<br>0 : Disable |
| <i>show</i> | Display current status (enabled /disabled) for each item.                                                                                                                                                                                                                    |

### Example

```

> sys dashboard -0 1
Front Panel enabled
> sys dashboard show
Front Panel enabled
System Information enabled
IPv4 LAN Information enabled
IPv4 Internet Access enabled
IPv6 Internet Access enabled
Interface enabled
Security enabled
System Resource enabled
LTE Status enabled
Quick Access enabled
VoIP enabled

```

### Telnet Command: sys app\_statistic

This command is used to enable/disable the statistics for APP services. To check the traffic for each APP service, access to the VigorACS server for detailed information.

#### Syntax

```

sys app_statistic -v
sys app_statistic -e <0/1>
sys app_statistic -l
sys app_statistic -p <app idx>
sys app_statistic -q <app idx>

```

#### Syntax Description

| Parameter    | Description                                                                                                                                                                           |
|--------------|---------------------------------------------------------------------------------------------------------------------------------------------------------------------------------------|
| -v           | Display current status of the function of APP service statistic.                                                                                                                      |
| -e <0/1>     | Enable or disable the function of APP service statistic.                                                                                                                              |
| -l           | Display all the applications arranged with index numbers.                                                                                                                             |
| -p <app idx> | Enable the statistic function for the specified APP.<br><app idx> : The applications supported by this CPE might increase in the future. At present, the available range is 0 to 156. |
| -q <app idx> | Disable the statistic function for the specified APP.                                                                                                                                 |

---

|                                                                                                                               |
|-------------------------------------------------------------------------------------------------------------------------------|
| <app idx> : The applications supported by this CPE might increase in the future. At present, the available range is 0 to 156. |
|-------------------------------------------------------------------------------------------------------------------------------|

---

### Example

```
> sys app_statistic -e 1
App service statistic mechanism : enable
```

## Telnet Command: sys webhook

This command is used to send a report (webhook message) including WAN up, down, CPU usage, memory usage and etc. to a monitoring server periodically.

### Syntax

```
sys webhook send
sys webhook status
sys webhook enable <0/1>
sys webhook url <server_url>
sys webhook period <value>
```

### Syntax Description

| Parameter                     | Description                                                                 |
|-------------------------------|-----------------------------------------------------------------------------|
| <i>send</i>                   | Trigger the webhook report immediately.                                     |
| <i>status</i>                 | Display the webhook current setting.                                        |
| <i>enable &lt;0/1&gt;</i>     | Enable (1) or disable (1) the webhook function.                             |
| <i>url &lt;server_url&gt;</i> | Specify the webhook server URL.<br><server_url> - Enter the URL.            |
| <i>period &lt;value&gt;</i>   | Set the webhook report period.<br><value> - Range from 1 to 1440 (minutes). |

### Example

```
> sys webhook enable 1
Set webhook ok
> sys webhook period 100
Set webhook ok

> sys webhook status
webhook is on
Monitoring Server URL:
Report Period: 100
```

## Telnet Command: testmail

This command is used to display current settings for sending test mail.

### Example

```
> testmail
Send out test mail
Mail Alert:[Enable]
Interface :Any
```



```
WAN_Alias index:[0]
SMTP_Server:[255.255.255.255]
SMTP_Port:[25]
Mail to:[]
Return-Path:[]
Connection Security:[Plaintext]
```

### Telnet Command: upnp off

This command can close UPnP function.

#### Example

```
>upnp off
UPNP say bye-bye
```

### Telnet Command: upnp on

This command can enable UPnP function.

#### Example

```
>upnp on
UPNP start.
```

### Telnet Command: upnp nat

This command can display IGD NAT status.

#### Example

```
> upnp nat ?
***** IGD NAT Status *****

((0))
InternalClient >>192.168.1.10<<, RemoteHost >>0.0.0.0<<
InternalPort >>21<<, ExternalPort >>21<<
PortMapProtocol >>TCP<<
The tmpvirtual server index >>0<<
PortMapLeaseDuration >>0<<, PortMapEnabled >>0<<
Ftp Example [MICROSOFT]
((1))
InternalClient >>0.0.0.0<<, RemoteHost >>0.0.0.0<<
InternalPort >>0<<, ExternalPort >>0<<
PortMapProtocol >><NULL><<
The tmpvirtual server index >>0<<
PortMapLeaseDuration >>0<<, PortMapEnabled >>0<<
PortMapProtocol >><NULL><<
The tmpvirtual server index >>0<<
PortMapLeaseDuration >>0<<, PortMapEnabled >>0<<
0<<

--- MORE --- ['q': Quit, 'Enter': New Lines, 'Space Bar': Next Page] ---
```

### Telnet Command: upnp service

This command can display the information of the UPnP service. UPnP service must be enabled first.

## Example

```
> upnp on
UPNP start.

> upnp service
>>>> SERVICE TABLE1 <<<<<
  serviceType urn:schemas-microsoft-com:service:OSInfo:1
  serviceId   urn:microsoft-com:serviceId:OSInfo1
  SCPDURL    /upnp/OSInfo.xml
  controlURL  /OSInfo1
  eventURL   /OSInfoEvent1
  UDN        uuid:774e9bbe-7386-4128-b627-001daa843464

>>>> SERVICE TABLE2 <<<<<
  serviceType urn:schemas-upnp-org:service:WANCommonInterfaceConfig:1
  serviceId   urn:upnp-org:serviceId:WANCommonIFC1
  SCPDURL    /upnp/WComIFCX.xml
  controlURL  /upnp?control=WANCommonIFC1
  eventURL   /upnp?event=WANCommonIFC1
  UDN        uuid:2608d902-03e2-46a5-9968-4a54ca499148
.
.
.
```

## Telnet Command: upnp subscribe

This command can show all UPnP services subscribed.

## Example

```
> upnp on
UPNP start.
> upnp subscribe
> upnp subscribe
>>>> (1) serviceType urn:schemas-microsoft-com:service:OSInfo:1

----- Subscribtion1 -----

  sid = 7a2bbdd0-0047-4fc8-b870-4597b34da7fb

  eventKey =1, ToSendEventKey = 1

  expireTime =6926

  active =1

  DeliveryURLs
=<http://192.168.1.113:2869/upnp/eventing/twtnpnsiu>

>>>> (2) serviceType
urn:schemas-upnp-org:service:WANCommonInterfaceConfig:1

----- Subscribtion1 -----

  sid = d9cd47a5-d9c9-4d3d-8043-d03a82f27983
```

```

eventKey =1, ToSendEventKey = 1
.
.
.

```

## Telnet Command: upnp tmpvs

This command can display current status of temp Virtual Server of your router.

### Example

```

> upnp tmpvs
***** Temp virtual server status *****

((0))
real_addr >>192.168.1.10<<, pseudo_addr >>172.16.3.229<<
real_port >>0<<, pseudo_port >>0<<
hit_portmap_index >>0<<
The protocol >>TCP<<
time >>0<<

((1))
real_addr >>0.0.0.0<<, pseudo_addr >>0.0.0.0<<
real_port >>0<<, pseudo_port >>0<<
hit_portmap_index >>0<<
The protocol >>0<<
time >>0<<
--- MORE ---  ['q': Quit, 'Enter': New Lines, 'Space Bar': Next Page] ---

```

## Telnet Command: upnp wan

This command is used to specify WAN interface to apply UPnP.

### Syntax

upnp wan <n>

### Syntax Description

| Parameter | Description                                                                                                                                            |
|-----------|--------------------------------------------------------------------------------------------------------------------------------------------------------|
| <i>n</i>  | It means to specify WAN interface (0 to 6) to apply UPnP.<br>n=0, it means to auto-select WAN interface.<br>n=1, WAN1<br>n=2, WAN2.<br>..<br>n=6, WAN6 |

### Example

```

> upnp wan 1
use wan1 now.

```

## Telnet Command: usb list

This command is use to display the information about the brand name and model name of the USB modems which are supported by Vigor router.

### Example

```
> usb list ?
Brand      Module                Standard
-----
4G system  XSPlug P3             3.5G      Y
Aiko       Aiko 76E              3.5G      Y
Alcatel    Alcatel X500          3.5G      Y
Alfa       ALFA Flyppp           3.5G      Y
Amoi       Amoi H01              3.5G      Y
BandRich   Bandlux C321          3.5G      Y
BandRich   Bandlux C330          3.5G      Y
BandRich   Bandlux C331          3.5G      Y
BandRich   Bandlux C502          3.5G      Y
BigPond    BigPond Next G Wir    3.5G      Y
BigPond    Broadband USB Mobi    3.5G      Y
Huawei     Huawei E150           3.5G      Y
Huawei     Huawei E153           3.5G      Y
Huawei     Huawei E172           3.5G      Y
Huawei     Huawei E176c          3.5G      M
Huawei     Huawei E270           3.5G      Y
Huawei     Huawei E3131          3.5G      Y
Huawei     Huawei E3272          3.5G      Y
Huawei     Huawei E3276s         LTE       Y
Huawei     Huawei E367           3.5G      Y
Huawei     Huawei E398           LTE       Y

Huawei     Huawei EC228          3.5G      Y
--- MORE ---  ['q': Quit, 'Enter': New Lines, 'Space Bar': Next Page] ---
```

### Telnet Command: usb user

This command is used to set profiles for FTP/SMB users.

#### Syntax Description

usb user add <Index> <Username> <Password> <Permission> <Home path>

usb user rm <Index>

usb user enable <Index>

usb user disable <Index>

usb user list

#### Syntax Description

| Parameter                                                        | Description                                                                                                                                                                                                                                                                                                                                                                                                                                                                            |
|------------------------------------------------------------------|----------------------------------------------------------------------------------------------------------------------------------------------------------------------------------------------------------------------------------------------------------------------------------------------------------------------------------------------------------------------------------------------------------------------------------------------------------------------------------------|
| add <Index> <Username><br><Password> <Permission><br><Home path> | Add a new user profile.<br><Index>: It means the index number of the user profile. There are 16 profiles allowed to be configured. So the range of such option is 1 ~ 16.<br><Username>: Enter a text (maximum 131 characters) as the username for the user profile.<br><Password>: Enter a text (maximum 131 characters) as the password for the user profile.<br><Permission>: Specify the action (RWDLCR) permitted. If one of the actions is not allowed, simple type “.” instead. |

|                        |                                                                                                                                                                                                                         |
|------------------------|-------------------------------------------------------------------------------------------------------------------------------------------------------------------------------------------------------------------------|
|                        | R - Read File.<br>W - Write File.<br>D - Delete File.<br>L - List directory.<br>C - Create directory.<br>R - Remove selected directory.<br><Home path>: Set the path (maximum 159 characters) for the USB user profile. |
| <i>rm</i> <Index>      | Delete an existed user profile.<br><Index>: It means the index number of the user profile.                                                                                                                              |
| <i>enable</i> <Index>  | Enable a user profile.<br><Index>: It means the index number of the user profile.                                                                                                                                       |
| <i>disable</i> <Index> | Disable a user profile.<br><Index>: It means the index number of the user profile.                                                                                                                                      |
| <i>list</i>            | Display all of the user profile.                                                                                                                                                                                        |

### Example

```
> usb user add 1 root 1234 R-DLCR /usr
> No usb storage is available!!
```

### Telnet Command: usb temp

This command is to configure USB temperature.

#### Syntax Description

```
usb temp set <-c|-f|-a|-b|-m|-u|-l|-r>
usb temp show
usb temp all_data
```

#### Syntax Description

| Parameter             | Description                                                                                                                                                                                        |
|-----------------------|----------------------------------------------------------------------------------------------------------------------------------------------------------------------------------------------------|
| <i>set -c</i>         | Set the temperature unit (Celsius).                                                                                                                                                                |
| <i>set -f</i>         | Set the temperature unit (Fahrenheit).                                                                                                                                                             |
| <i>set -a</i>         | Set the temperature sensor by using a probe or the built-in sensor automatically.<br>The probe will be detected and used first, and fall back to the built-in sensor if the probe is not detected. |
| <i>set -b</i>         | Set to use the built-in sensor.                                                                                                                                                                    |
| <i>set -m</i>         | Enable or disable the Alarm Setting.<br>1: Enable<br>0: Disable                                                                                                                                    |
| <i>set -u</i> <value> | Set the upper temperature limit.<br><value>: Enter a value, e.g., 30.35.                                                                                                                           |
| <i>set -l</i> <value> | Set the lower temperature limit.<br><value>: Enter a value, e.g., 10.35.                                                                                                                           |
| <i>set -r</i>         | Shows the setting of temperature unit and sensor type.                                                                                                                                             |
| <i>show</i>           | Displays current temperature.                                                                                                                                                                      |
| <i>all_data</i>       | Displays all temperature data.                                                                                                                                                                     |

### Example

```

> usb temp set -r
Show setting:temp set -r

Alarm Settings: 1 (0:Disable, 1: Enable.)
upper temperature limit: 30.0 C
lower temperature limit: 18.0 C
unit: 0 (0:Celsius, 1: Fahrenheit.)
sensor: 1 (0:Auto select, 1: built-in.)
> usb temp set -c
Set Celsius.

```

## Telnet Command: usb hum

This command is to configure USB humidity.

### Syntax Description

```

usb hum set <m/-u/-l/-r>
usb hum show
usb hum all_data

```

### Syntax Description

| Parameter                   | Description                                                           |
|-----------------------------|-----------------------------------------------------------------------|
| <i>set -m</i>               | Enable or disable the Alarm Setting.<br>1: Enable<br>0: Disable       |
| <i>set -u &lt;value&gt;</i> | Set the upper humidity limit.<br><value>: Enter a value, e.g., 80.85. |
| <i>set -l &lt;value&gt;</i> | Set the lower humidity limit.<br><value>: Enter a value, e.g., 30.12. |
| <i>set -r</i>               | Shows the setting of the humidity.                                    |
| <i>show</i>                 | Displays current humidity.                                            |
| <i>all_data</i>             | Displays all humidity data.                                           |

### Example

```

> usb hum set -m 1
Enable Alarm Settings.
>

```

## Telnet Command: vigbrg set

This command is to configure specified WAN as bridge mode.

### Syntax Description

```

vigbrg set -v <IP version> -w <WAN_idx> -l <LAN_idx> -e <0/1> -f <0/1>

```

### Syntax Description

| Parameter                    | Description                                                           |
|------------------------------|-----------------------------------------------------------------------|
| <i>-v &lt;IP version&gt;</i> | Indicate the IP version for the IP address.<br>4 - IPv4.<br>6 - IPv6. |

|                     |                                                                                                                               |
|---------------------|-------------------------------------------------------------------------------------------------------------------------------|
| <i>w</i> <WAN_idx>  | WAN_idx - Indicate the WAN interface.<br>1 - WAN1<br>2 - WAN2<br>3 - WAN3<br>4 - WAN4<br>5 - WAN5                             |
| <i>-l</i> <LAN_idx> | LAN_idx - Indicate the LAN interface.<br>1 - LAN1<br>2 - LAN2<br>3 - LAN3<br>4 - LAN4<br>5 - LAN5<br>6 - LAN6 .... 15 - LAN15 |
| <i>-e</i> <0/1>     | Enable (1) or disable (0) the Vigor Bridge for WAN or/and LAN.                                                                |
| <i>-f</i> <0/1>     | Enable (1) or disable (0) the firewall functions.                                                                             |

### Example

```
> vigbrg set -v 4 -w 5 -l 1 -e 1
[WAN5] IPv4 bridge is enable. Set subnet[LAN1]
```

### Telnet Command: vigbrg closeall

This command can disable vigor bridge function.

### Example

```
> vigbrg closeall
Close all bridge and bridge firewall
```

### Telnet Command: vigbrg status

This command can show whether the Vigor Bridge Function is enabled or disabled.

### Example

```
> vigbrg status
Show gConfig setting of bridge mode

%Wan1 management is disable!
```

### Telnet Command: vigbrg cfgip

This command allows users to transfer a bridge modem into ADSL router by accessing into and adjusting specified IP address. Users can access into Web UI of the router to manage the router through the IP address configured here.

### Syntax

vigbrg cfgip <IP Address>

### Syntax Description

| Parameter         | Description                                                    |
|-------------------|----------------------------------------------------------------|
| <i>IP Address</i> | It means to type an IP address for users to manage the router. |

## Example

```
> vigbrg cfgip 192.168.1.15
> vigbrg cfgip ?
% Vigor Bridge Config IP,
% Now: 192.168.1.15
```

## Telnet Command: vigbrg wanstatus

This command can display the existed WAN connection status for the modem (change from ADSL router into bridge modem), including index number, MAC address, Stamp Time, PVC, VLAN port for Vigor Bridge Function..

### Example

```
> vigbrg wanstatus
Vigor Bridge: Running
WAN mac table:
Index  MAC Address                Stamp Time  PVC          VLan      Port
```

## Telnet Command: vigbrg wlanstatus

This command can display the existed WLAN connection status for the modem (change from router into bridge modem), including index number, MAC address, Stamp Time, PVC, VLAN port for Vigor Bridge Function.

### Example

```
> vigbrg wlanstatus
Vigor Bridge: Running
WAN mac table:
Index  MAC Address                Stamp Time  PVC          VLan      Port
```

## Telnet Command: fullbrg

The command is used to enable Full Bridge Mode so that the router will work as a bridge modem which is able to forward incoming packets with VLAN tags.

### Syntax

fullbrg status

fullbrg set -i <WAN index> -n <Subnet index> -b <Bridge mode>

### Syntax Description

| Parameter         | Description                                                                                            |
|-------------------|--------------------------------------------------------------------------------------------------------|
| -i <WAN index>    | WAN index: Ranges from 1 to 16.<br>1: WAN1, 2: WAN2, ...etc.,<br>In which, WAN3 and WAN 4 are USB WAN. |
| -n <Subnet index> | Subnet index: Ranges from 1 to 8.<br>1: Subnet 1, 2: Subnet 2, ...etc.                                 |
| -b <Bridge mode>  | It means to enable / disable Bridge mode.<br>0: OFF<br>1: ON                                           |



## Example

```
> fullbrg status ?
Show gConfig setting of full bridge
WAN 1 full bridge to LAN 1, mode=OFF.
WAN 2 full bridge to LAN 1, mode=OFF.
WAN 3 full bridge to LAN 1, mode=OFF.
WAN 4 full bridge to LAN 1, mode=OFF.
WAN 7 full bridge to LAN 1, mode=OFF.
WAN 8 full bridge to LAN 1, mode=OFF.
WAN 9 full bridge to LAN 1, mode=OFF.
WAN10 full bridge to LAN 1, mode=OFF.
WAN11 full bridge to LAN 1, mode=OFF.
WAN12 full bridge to LAN 1, mode=OFF.
WAN13 full bridge to LAN 1, mode=OFF.
WAN14 full bridge to LAN 1, mode=OFF.
WAN15 full bridge to LAN 1, mode=OFF.
WAN16 full bridge to LAN 1, mode=OFF.
> fullbrg set -i 2 -n 5 -b 1
Configure OK! Please reboot device to make it effective.
> fullbrg status
Show gConfig setting of full bridge
WAN 1 full bridge to LAN 1, mode=OFF.
WAN 2 full bridge to LAN 5, mode=ON.
WAN 3 full bridge to LAN 1, mode=OFF.
WAN 4 full bridge to LAN 1, mode=OFF.
WAN 7 full bridge to LAN 1, mode=OFF.
WAN 8 full bridge to LAN 1, mode=OFF.
WAN 9 full bridge to LAN 1, mode=OFF.
WAN10 full bridge to LAN 1, mode=OFF.
WAN11 full bridge to LAN 1, mode=OFF.
WAN12 full bridge to LAN 1, mode=OFF.
WAN13 full bridge to LAN 1, mode=OFF.
WAN14 full bridge to LAN 1, mode=OFF.
WAN15 full bridge to LAN 1, mode=OFF.
WAN16 full bridge to LAN 1, mode=OFF.
>
```

## Telnet Command: voip debug

This command can display debug message on the screen.

### Syntax

```
voip debug <flush>
```

```
voip debug <showmsg>
```

### Syntax Description

| Parameter      | Description                    |
|----------------|--------------------------------|
| <i>flush</i>   | It means to clear current log. |
| <i>showmsg</i> | It means to show current log.  |

### Example

```
> voip debug showmsg
```

```

-->Send Message to 192.168.1.2:5060 <02:35:16>
INVITE sip:192.168.1.2 SIP/2.0
Via: SIP/2.0/UDP 192.168.1.1:5060;branch=z9hG4bK-YMa-3630;rport
From: <sip:change_me@192.168.1.1>;tag=WLJ-11782
To: <sip:192.168.1.2>
Call-ID: PbU-25312@192.168.1.1
CSeq: 1 INVITE
Contact: <sip:change_me@192.168.1.1>
Max-Forwards: 70
supported: 100rel, replaces
User-Agent: DrayTek UA-1.2.3 DrayTek Vigor2910
Allow: INVITE, ACK, CANCEL, OPTIONS, BYE, INFO, REFER, NOTIFY, PRACK
Content-Type: application/sdp
Content-Length: 264

v=0
o=change_me 5972727 56415 IN IP4 192.168.1.1

```

## Telnet Command: voip dialplan

This command allows users to set phone book settings.

### Syntax

```

voip dialplan block n [-<command><parameter>]
voip dialplan phonebook n [-<command><parameter>]
voip dialplan region [-<command><parameter>]
voip dialplan local <1/0>

```

### Syntax Description

| Parameter                  | Description                                                                                                                        |
|----------------------------|------------------------------------------------------------------------------------------------------------------------------------|
| <b>voip dialplan block</b> |                                                                                                                                    |
| <i>n</i>                   | It means the index number of the VoIP settings.<br>n=1 ~ 20                                                                        |
| -<command><parameter>      | The available commands with parameters are listed below.                                                                           |
| -m 0/1                     | It means to enable or disable the block mode.<br>0 - Disable<br>1 - Enable                                                         |
| -p <path>                  | Determines the block path.<br>1:in_url,<br>2:in_number<br>3:out_url,<br>4:out_number<br>5:(in & out)_url,<br>6:(in & out)_number ) |
| -n <number>                | Determines the block number (maximum 29 characters).                                                                               |
| -d <domain>                | Block the specified domain.                                                                                                        |
| -i <inf>                   | Block the specified interface(s) or All interfaces.                                                                                |
| -s <Schedule>              | Specify schedule profiles by indicating the index number of the schedule profile. Four schedule profiles can be used at one time.  |
| -w                         | Delete the selected entry. N=null (clear all)                                                                                      |
| -v                         | List current settings.                                                                                                             |

| voip dialplan phonebook |                                                                                   |
|-------------------------|-----------------------------------------------------------------------------------|
| <i>n</i>                | It means the index number of the VoIP settings.<br>n=1 - 60                       |
| -<command><parameter>   | The available commands with parameters are listed below.                          |
| -d <number>             | Specify the speed dial number.                                                    |
| -c <url>                | Contact SIP URL l(max. 59 characters)                                             |
| -n <name>               | Contact name (max. 23 characters)                                                 |
| -a <enable>             | Enable/disable the specify entry.                                                 |
| -m <mode>               | Specify backup number mode.<br>0 - none<br>2 - PSTN                               |
| -b <number>             | Specify the backup number.                                                        |
| -o <acc num>            | Specify the dial out account.<br>0 - default<br>1 - acc1, 2 - acc2... - 12:=acc12 |
| -z <enable>             | Enable/disable ZRTP/SRTP VoIP security.<br>1 - enable<br>0 - disable              |
| -l                      | Delete the specify entry.                                                         |
| -V                      | List current VoIP settings.                                                       |
| voip dialplan region    |                                                                                   |
| -e                      | Enable or disable the regional function.<br>1 - enable<br>0 - disable             |
| -m <number>             | Return the last miss call.                                                        |
| -l <number>             | Return the last incoming call.                                                    |
| -o <number>             | Return the last outgoing call.                                                    |
| -F <number>             | Hotkey to enable call forwarding (all) function.                                  |
| -f <number>             | Hotkey to enable call forwarding (busy) function.                                 |
| -C <number>             | Hotkey to enable call forwarding (no answer) function.                            |
| -c <number>             | Hotkey to disable call forwarding function.                                       |
| -W <number>             | Hotkey to enable call waiting function.                                           |
| -w <number>             | Hotkey to disable call waiting function.                                          |
| -H <number>             | Hotkey to enable hide caller ID function.                                         |
| -h <number>             | Hotkey to disable hide caller ID function.                                        |
| -D <number>             | Hotkey to enable DND function.                                                    |
| -d <number>             | Hotkey to disable DND function.                                                   |
| -A <number>             | Hotkey to enable block anonymous calls function.                                  |
| -a <number>             | Hotkey to disable block anonymous calls function.                                 |
| -U <number>             | Hotkey to enable block unknow domain calls function.                              |
| -u <number>             | Hotkey to disable block unknow domain calls function.                             |
| -P <number>             | Hotkey to disable block IP calls function.                                        |
| -p <number>             | Hotkey to disable block IP calls function.                                        |
| -l <number>             | Hotkey to block last incoming call.                                               |
| -v                      | List current status for Regional settings.                                        |
| voip dialplan local     |                                                                                   |

|                       |                                                                 |
|-----------------------|-----------------------------------------------------------------|
| <i>enable/disable</i> | Enable or disable the local calls.<br>1 - enable<br>0 - disable |
|-----------------------|-----------------------------------------------------------------|

## Example

```

> voip dialplan phonebook 1 -d 1125
> voip dialplan region -l 8
> voip dialplan region -v
Your Setting for Regional
Regional Function is: Enable
Return the Last Miss Call: 20
Return the Last Incoming Call: *12
Return the Last Outgoing Call: 1
Hotkey to enable call forwarding (all) function: 0
Hotkey to enable call forwarding (busy) function: *90
Hotkey to enable call forwarding (no answer) function: *92
Hotkey to disable call forwarding function: 12
Hotkey to Enable Call Waiting Function: *56
Hotkey to Disable Call Waiting Function: *57
Hotkey to Enable Hide Caller ID Function: *67
Hotkey to Disable Hide Caller ID Function: *68
Hotkey to Enable DND Function: *78
Hotkey to Disable DND Function: *79
Hotkey to Enable Block Anonymous Calls Function: *77
Hotkey to Disable Block Anonymous Calls Function: *87
Hotkey to Enable Block Unknow Domain Calls Function: *40
Hotkey to Disable Block Unknow Domain Calls Function: *04
Hotkey to Enable Block IP Calls Function: *50
Hotkey to Disable Block IP Calls Function: *05
Hotkey to Disable Block The Last Incoming Call Function: 8

```

## Telnet Command: voip dsp

### Syntax

```

voip dsp countrytone [channel] [value]
voip dsp dialtonepwr [channel] [AbsoluteValue]
voip dsp EchoCanceller [type] [w_size] [nlp]
voip dsp cidtype [channel] [value]
voip dsp micgain [channel] [value/(1-10)]
voip dsp spkgain [channel] [value/(1-10)]
voip dsp jb [port] [mode] [value]
voip dsp timer [Timer]
voip dsp dtmfDetset [nLevel] [nTwist]
voip dsp dtmfTonepwr [Level]
voip dsp cwtonepwr [ch] [value]
voip dsp pstnringfxs [1|2] [on/off]
voip dsp relaydbounce [on/off]
voip dsp setRingPat [ring_pattern_index] [patten_num]
voip dsp setFaxECmode
voip dsp setDtmfCidlevel -l [value]
voip dsp setDtmfCidlevel -h [value]

```

```

voip dsp setDtmfCidlevel -r 0
voip dsp setfxoCY
voip dsp cidplusdigit [1/0] [channel] [value]
voip dsp setfxoringl
voip dsp setfxoCid
voip dsp cidplusdigit
voip dsp setRingThres
voip dsp setCidDetGain
voip dsp UnlimitedRing

```

## Syntax Description

| Parameter                    | Description                                                                                                                                                                                                                                                                                                                                                                                              |
|------------------------------|----------------------------------------------------------------------------------------------------------------------------------------------------------------------------------------------------------------------------------------------------------------------------------------------------------------------------------------------------------------------------------------------------------|
| <b>voip dsp countrytone</b>  |                                                                                                                                                                                                                                                                                                                                                                                                          |
| <i>[channel] [value]</i>     | This command allows users to set the region for the tone settings. Different regions usually need different tone settings.<br>Channel - 1 or 2.<br>Value - displayed as follows:<br>[2] UK, [3] USA, [4] Denmark, [5] Italy, [6] Germany, [7] Netherlands, [8] Portugal, [9] Sweden, [10] Australia, [11] Slovenia, [12] Czech, [13] Slovakia, [14] Hungary, [15] Switzerland , [16] France , [17] Malta |
| <b>voip dsp dialtonepwr</b>  |                                                                                                                                                                                                                                                                                                                                                                                                          |
| <i>channel</i>               | This setting is used to adjust the loudness of the dial tone. The smaller the number is, the louder the dial tone is. It is recommended for you to use the default setting.<br>Channel - Available channel number: 1 - 2                                                                                                                                                                                 |
| <i>AbsoluteValue</i>         | AbsoluteValue - In -1 dB increments, with 1 corresponding to 6 dBm.<br>Range - 1 to 30                                                                                                                                                                                                                                                                                                                   |
| <b>voip dsp EchoCanceler</b> |                                                                                                                                                                                                                                                                                                                                                                                                          |
| <i>type</i>                  | This command is used to set the type of echo reduction.<br>0 - Disable the LEC processing.<br>1 - Cancel using the fixed window.<br>2 - Cancel using the fixed and moving window.<br>3 - Cancel using fixed window + Echo Suppressor.                                                                                                                                                                    |
| <i>w_size</i>                | The Line Echo Canceller (LEC) window size is 4, 6, 8 or 16 (ms).                                                                                                                                                                                                                                                                                                                                         |
| <i>nlp</i>                   | Nlp - Non-linear processing (NLP) for more smooth transitions.<br>1 - disable<br>0 - enable                                                                                                                                                                                                                                                                                                              |
| <b>voip dsp cidtype</b>      |                                                                                                                                                                                                                                                                                                                                                                                                          |
| <i>channel</i>               | Set the caller ID type for FXS 1 (Channel 1) or FXS 2 (Channel 2).<br>1 - FXS 1<br>2 - FXS 2                                                                                                                                                                                                                                                                                                             |
| <i>value</i>                 | Each number (1 to 6) represents different type.<br>1 - FSK_ETSI<br>2 - FSK_ETSI(UK)<br>3 - FSK_BELLCORE(US/AU)<br>4 - DTMF<br>5 - DTMF(Dk)<br>6 - DTMF(SE,NL,FIN)<br>For example :                                                                                                                                                                                                                       |

|                            |                                                                                                                                                                                                                                                                                                                                                                                                                                                                                                                                                                                                                                           |
|----------------------------|-------------------------------------------------------------------------------------------------------------------------------------------------------------------------------------------------------------------------------------------------------------------------------------------------------------------------------------------------------------------------------------------------------------------------------------------------------------------------------------------------------------------------------------------------------------------------------------------------------------------------------------------|
|                            | Vigor> voip dsp cidtype 2 6<br>channel=2, current cidType: 6<br>That means the caller ID type for FXS2 (Channel2) is DTMF (SE, NL, FIN).                                                                                                                                                                                                                                                                                                                                                                                                                                                                                                  |
| <i>voip dsp micgain</i>    |                                                                                                                                                                                                                                                                                                                                                                                                                                                                                                                                                                                                                                           |
| <i>channel</i>             | Adjust the volume of microphone by entering number from 1- 10 for FXS 1 or FXS 2.<br>1 - FXS 1<br>2 - FXS 2                                                                                                                                                                                                                                                                                                                                                                                                                                                                                                                               |
| <i>value/(1-10)</i>        | The larger the number is, the louder the volume will be.                                                                                                                                                                                                                                                                                                                                                                                                                                                                                                                                                                                  |
| <i>voip dsp spkgain</i>    |                                                                                                                                                                                                                                                                                                                                                                                                                                                                                                                                                                                                                                           |
| <i>channel</i>             | Adjust the volume of speaker by entering number from 1- 10 for FXS 1 or FXS 2.<br>1 - FXS 1<br>2 - FXS 2                                                                                                                                                                                                                                                                                                                                                                                                                                                                                                                                  |
| <i>value/(1-10)</i>        | The larger the number is, the louder the volume will be.                                                                                                                                                                                                                                                                                                                                                                                                                                                                                                                                                                                  |
| <i>voip dsp jb</i>         |                                                                                                                                                                                                                                                                                                                                                                                                                                                                                                                                                                                                                                           |
| <i>port</i>                | Set the size of jitter buffer.<br>Available settings are 0 (FXS1) and 1 (FXS2).                                                                                                                                                                                                                                                                                                                                                                                                                                                                                                                                                           |
| <i>mode</i>                | Available settings are Fixed and Adaptive (default setting).                                                                                                                                                                                                                                                                                                                                                                                                                                                                                                                                                                              |
| <i>value</i>               | Available settings are 1 ~ 180 (unit: msec).<br>e.g.,<br>Vigor> voip dsp jb 1 FIXED 100                                                                                                                                                                                                                                                                                                                                                                                                                                                                                                                                                   |
| <i>voip dsp timer</i>      |                                                                                                                                                                                                                                                                                                                                                                                                                                                                                                                                                                                                                                           |
| <i>[Timer]</i>             | Set the waiting time for dialing out.<br>It means to set the timer settings. The unit is mini-second. The range is from 1 to 255. Value "1" is corresponding to 500ms. That is to say, Value "6" is corresponding 3000ms (i.e., 3 seconds)<br>Timer: 1 ~ 20.<br>Vigor> voip dsp timer 20<br>Set the timer:20                                                                                                                                                                                                                                                                                                                              |
| <i>Voip dsp debugMsg</i>   |                                                                                                                                                                                                                                                                                                                                                                                                                                                                                                                                                                                                                                           |
| <i>?</i>                   | Available settings include:<br>clrev - clear phone hook status.<br>getev - get phone hook status.<br>clrfskcid - clear fsk data for caller-ID from PSTN line.<br>getfskcid - get fsk data for caller-ID from PSTN line.<br>clrdtmfcid - clear dtmf data for caller-ID from PSTN line.<br>getdtmfcid - get dtmf data for caller-ID from PSTN line.<br>voicebuf - get message for available voice buffer pool.<br>clrint - clear status for interrupt.<br>getint - get status for interrupt.<br>Vigor> voip dsp debugMsg getint<br>the interrupt status for ad0 = 21<br>the interrupt status for ad1 = 0<br>the interrupt status for vc = 0 |
| <i>voip dsp dtmfDetset</i> |                                                                                                                                                                                                                                                                                                                                                                                                                                                                                                                                                                                                                                           |
| <i>nLevel</i>              | Set minimal signal level in dB, for DTMF detection.<br>Range - (-96 ~ -1)                                                                                                                                                                                                                                                                                                                                                                                                                                                                                                                                                                 |
| <i>nTwist</i>              | Maximum allowed signal twist in dB, for DTMF detection.<br>Range - (0 ~ 12)                                                                                                                                                                                                                                                                                                                                                                                                                                                                                                                                                               |
| <i>voip dsp dtmfTonep</i>  |                                                                                                                                                                                                                                                                                                                                                                                                                                                                                                                                                                                                                                           |

|                                                                                                                  |                                                                                                                                                                                                                                                                                                                                                                                       |
|------------------------------------------------------------------------------------------------------------------|---------------------------------------------------------------------------------------------------------------------------------------------------------------------------------------------------------------------------------------------------------------------------------------------------------------------------------------------------------------------------------------|
| <i>Level</i>                                                                                                     | Set power level for DTMF frequency.<br>Level - 0 ~ 100. Power level for dtmf frequency in 0.3 dB steps.<br>0 map to 0dB<br>1 map to -0.3dB .... 100 map to -30dB                                                                                                                                                                                                                      |
| <i>voip dsp cwtonepwr</i>                                                                                        |                                                                                                                                                                                                                                                                                                                                                                                       |
| <i>ch</i>                                                                                                        | Set the call waiting tone power level.<br>1 - FXS 1<br>2 - FXS 2.                                                                                                                                                                                                                                                                                                                     |
| <i>value</i>                                                                                                     | 1 ~ 30, in -1 dB increments, with 1 corresponding to 8 dBm.                                                                                                                                                                                                                                                                                                                           |
| <i>voip dsp pstnringfxs</i>                                                                                      |                                                                                                                                                                                                                                                                                                                                                                                       |
| <i>1/2</i>                                                                                                       | Enable or disable PSTN ring on FXS 1/FXS 2.<br>1 meansFXS1; 2 means FXS2.                                                                                                                                                                                                                                                                                                             |
| <i>on/off</i>                                                                                                    | On means enable; off means disable.                                                                                                                                                                                                                                                                                                                                                   |
| <i>voip dsp relaydbounce</i>                                                                                     |                                                                                                                                                                                                                                                                                                                                                                                       |
| <i>on/off</i>                                                                                                    | on: Enable relay filter noise. But it maybe ignore the caller-id!!!<br>off: Disable relay filter noise. But the noise will cause the relay to switch to PSTN!!!                                                                                                                                                                                                                       |
| <i>voip dsp setRingPat</i>                                                                                       |                                                                                                                                                                                                                                                                                                                                                                                       |
| <i>ring_pattern_index</i>                                                                                        | This command can change the ring pattern at Index(2)-Index(6).<br>ring_pattern_index - Index (1) was locked for your country.                                                                                                                                                                                                                                                         |
| <i>patten_num</i>                                                                                                | It's the ring pattern number (1-12) for a country.<br>-----<br><i>patten_num=1 Australia Ring Pattern:</i><br><i>cadenceOneOn=400, cadenceOneOff=200</i><br><i>cadenceTwoOn=400, cadenceTwoOff=2000</i><br><i>patten_num=2 Denmark Ring Pattern:</i><br><i>cadenceOneOn=1000, cadenceOneOff=4000</i><br>.....                                                                         |
| <i>voip dsp setFaxECmode -s</i>                                                                                  |                                                                                                                                                                                                                                                                                                                                                                                       |
| <i>ch</i>                                                                                                        | Set the FAX error correction mode.<br>ch : range (0 ~ 1)                                                                                                                                                                                                                                                                                                                              |
| <i>mode</i>                                                                                                      | mode : EC(error correction) ch(x) mode(0) : REDUNDANCY<br>EC(error correction) ch(x) mode(1) : FEC                                                                                                                                                                                                                                                                                    |
| <i>voip dsp setDtmfCidlevel -l / voip dsp setDtmfCidlevel -h [value]</i><br><i>voip dsp setDtmfCidlevel -r 0</i> |                                                                                                                                                                                                                                                                                                                                                                                       |
| <i>value</i>                                                                                                     | "setDtmfCidLevel" is used to configure the signal strength for transferring to FXS DTMF caller ID.<br>value - 0 ~ 64<br>voip dsp setDtmfCidLevel -l [value]<br>voip dsp setDtmfCidLevel -h [value]<br>voip dsp setDtmfCidLevel -r 0/1<br>r - reset low/high DTNF level to default setting. 0 means Disable; 1 means Enable.<br>Note: This function is supported only by special mode. |
| <i>voip dsp setfxoCY</i>                                                                                         |                                                                                                                                                                                                                                                                                                                                                                                       |
| <i>value</i>                                                                                                     | It is used to apply FXO country settings.<br>0: "use system country"<br>1: "Taiwan"<br>2: "Germany"<br>3: "Sweden"<br>4: "France"                                                                                                                                                                                                                                                     |

|                                |                                                                                                                                                                                                                                                                                                                     |
|--------------------------------|---------------------------------------------------------------------------------------------------------------------------------------------------------------------------------------------------------------------------------------------------------------------------------------------------------------------|
|                                | 5: "Switzerland"<br>6: "Holland"<br>7: "Finland"<br>8: "Denmark"<br>9: "UK"<br>10: "Australia"<br>12: "Italy"<br>14: "Red_China"<br>15: "Singapore"<br>17: "Spain"<br>18: "Portugal"<br>20: "Poland"<br>21: "Czech"<br>22: "Hungary"<br>23: "Slovenia"<br>25: "Slovakia"<br>37: "Brasil"<br>61: "US"                |
| <i>voip dsp setfxoringl</i>    |                                                                                                                                                                                                                                                                                                                     |
| <i>value</i>                   | It is used to configure detection ring voltage threshold to apply to FXO.<br>Available setting include:<br>0 : use driver default value<br>1 : Minimum voltage threshold: 25V<br>2 : Minimum voltage threshold: 35V<br>3 : Minimum voltage threshold: 45V<br>Note: This function is supported only by special mode. |
| <i>voip dsp setfxoCid</i>      |                                                                                                                                                                                                                                                                                                                     |
| <i>value</i>                   | Set FXO detect caller ID type.<br>It is available only for the model with FXO port.                                                                                                                                                                                                                                 |
| <i>voip dsp cidplusdigit</i>   |                                                                                                                                                                                                                                                                                                                     |
| <i>[1/0] [channel] [value]</i> | Set the substitution (0-9) for '+' digit in caller ID.<br>1 - enable the substitution.<br>0 - disable the substitution.<br>channel - 0 (FXS 1) -1 (FXS 2)<br>value - 0 - 9                                                                                                                                          |
| <i>voip dsp setRingThres</i>   |                                                                                                                                                                                                                                                                                                                     |
| <i>port</i>                    | Set the threshold for ring signal.<br>Port setting is "0" only.                                                                                                                                                                                                                                                     |
| <i>value</i>                   | Available settings 0-250. Unit is ms.<br>The time is an approximate value.                                                                                                                                                                                                                                          |
| <i>voip dsp setCidDetGain</i>  |                                                                                                                                                                                                                                                                                                                     |
| <i>tx/rx gain</i>              | Set the gain value of caller ID detected.<br>Tx gain - Available settings -24 ~ 12. Default is 0.<br>Rx gain - Available settings -24 ~ 12. Default is -6.                                                                                                                                                          |

## Example

```

> voip dsp countrytone ?
VoIP has been disable. Please enable VoIP first.
> voip sip misc -D 0
System reboot now!
> voip dsp countrytone ?

```



```

> Vigor> voip dsp countrytone?
usage:
  voip dsp countrytone [channel][value]
  [channel]: 1-2
  [value]: ( [2] UK, [3] USA, [4] Denmark, [5] Italy, [6] Germany, [7] Netherland
s, [8] Portugal, [9] Sweden, [10] Australia, [11] Slovenia, [12] Czech, [13]
Slovakia, [14] Hungary, [15] Switzerland , [16] France , [17] Malta)
===== Channel=1 =====
  current country tone: user defined

----- ( Dial tone ) -----
  Feq1=425, Feq2=0, OneOn=0, Off=0, TwoOn=0, TwoOff=0
----- ( Ringing tone ) -----
  Feq1=425, Feq2=0, OneOn=1500, OneOff=3000, TwoOn=0, TwoOff=0
----- ( Busy tone ) -----
  Feq1=425, Feq2=0, OneOn=200, OneOff=200, TwoOn=0, TwoOff=0

===== Channel=2 =====
  current country tone: user defined
> voip dsp dialtonepwr 1 20
Current power level of dialtone:20 (-13 db), channel=1
> voip dsp setCidDetGain tx 1
  Current CID Detect Tx Gain [1], Rx Gain [-6]
> voip dsp setCidDetGain rx 3
  Current CID Detect Tx Gain [1], Rx Gain [3]

```

## Telnet Command: voip rtp

### Syntax

voip rtp codec [*sip acc index*][*type/size/vad/one*][*value*]

voip rtp dtmf [*index*] [*mode/payloadtype*][*value*]

voip rtp port [*start/end*] [*value*]

voip rtp symmetric [*value*]

voip rtp tos ?

### Syntax Description

| Parameter                                        | Description                                                                                                                                                                                                                                                                                                                                                                                                                                    |
|--------------------------------------------------|------------------------------------------------------------------------------------------------------------------------------------------------------------------------------------------------------------------------------------------------------------------------------------------------------------------------------------------------------------------------------------------------------------------------------------------------|
| <i>voip rtp codec</i>                            |                                                                                                                                                                                                                                                                                                                                                                                                                                                |
| <i>[sip acc index][type/size/vad/one][value]</i> | Set the voice coding.<br>sip acc index -SIP account index number. Available number, 1 - 12.<br>type - Available settings include<br>0. G.711MU<br>1. G.711A<br>2. G.729A/B<br>3. G.723<br>4. G.726_32<br>size - Five options,<br>0 means 10ms<br>1 means 20ms<br>2 means 30ms<br>3 means 40ms<br>5 means 60ms<br>Vad - 0 means to Disable the function of Voice Active Detector (vad); 1 means to Enable the function of Voice Active Detector |

|                                            |                                                                                                                                                                                                                                                                                                                                                                                 |
|--------------------------------------------|---------------------------------------------------------------------------------------------------------------------------------------------------------------------------------------------------------------------------------------------------------------------------------------------------------------------------------------------------------------------------------|
|                                            | (vad).<br>One - 0 means to Disable the function of single codec; 1 means to Enable the function of single codec.                                                                                                                                                                                                                                                                |
| <i>voip rtp dtmf</i>                       |                                                                                                                                                                                                                                                                                                                                                                                 |
| <i>[index] [mode   payloadtype][value]</i> | Set the DTMF mode and Payload type for DTMF.<br>Index - SIP account index number. Available number, 1 - 12.<br>Mode - Four options to be selected.<br>0. Inband<br>1. Outband<br>2. SIP INFO (cisco)<br>3. SIP INFO (nortel)<br>Payloadtype - Available settings 96-127.<br>Value - Type 0-3 or 96-127 based on the mode specified.<br>For example,<br>> voip rtp dtmf 1 mode 1 |
| <i>voip rtp port</i>                       |                                                                                                                                                                                                                                                                                                                                                                                 |
| <i>start/end</i>                           | Specifies the start/end port for RTP stream.                                                                                                                                                                                                                                                                                                                                    |
| <i>value</i>                               | The default value is 10050/15000.                                                                                                                                                                                                                                                                                                                                               |
| <i>voip rtp symmetric</i>                  |                                                                                                                                                                                                                                                                                                                                                                                 |
| <i>value</i>                               | Make the data transmission going through on both ends of local router and remote router not misleading due to IP lost.<br>1 - Enable<br>0 - Disable                                                                                                                                                                                                                             |
| <i>voip rtp tos</i>                        |                                                                                                                                                                                                                                                                                                                                                                                 |
| <i>value</i>                               | Set the type of service (TOS) setting for RTP packets.<br>For example,<br>> voip rtp tos 0x899<br>Set TOS: 0x899                                                                                                                                                                                                                                                                |

## Example

```
> voip rtp codec 1 type 3
> voip rtp dtmf 2 mode 3
> voip rtp port start 10070 end 14400
Set start port: 10070
> voip rtp port end 14400
Set end port: 14400
> voip rtp symmetric 1
Set symmetric rtp to Enable
```

## Telnet Command: voip sip

This command allows users to set SIP account.

### Syntax

```
voip sip acc n [-<command> <parameter> | ... ]
voip sip alias [-<command> <parameter> | ... ]
voip sip calllog
voip sip ep n [-<command> <parameter> | ... ]
voip sip misc[-<command> <parameter> | ... ]
voip sip nat [-<command> <parameter> | ... ]
```

## Syntax Description

| Parameter                                              | Description                                                                                                                                                                                                                            |
|--------------------------------------------------------|----------------------------------------------------------------------------------------------------------------------------------------------------------------------------------------------------------------------------------------|
| <i>voip sip acc</i> - Allows users to set SIP account. |                                                                                                                                                                                                                                        |
| <i>n</i>                                               | n = 1 to 12<br>It means the index number of the VoIP settings.                                                                                                                                                                         |
| <i>-P [profile]</i>                                    | It means the name of the account profile (maximum 11 characters).                                                                                                                                                                      |
| <i>-r [reg mode]</i>                                   | Set registration mode for SIP account.<br>0 - none<br>1 - auto<br>2 - wan1 only<br>3 - wan2 only<br>4 - lan/vpn<br>5 - PVC<br>6 - wan3 only<br>7 - wan4 only<br>8 - wan1 first<br>9 - wan2 first<br>10 - wan3 first<br>11 - wan4 first |
| <i>-o [port]</i>                                       | Set the port number for sending/receiving SIP message for building a session. The default value is 5060.                                                                                                                               |
| <i>-d [domain]</i>                                     | Set the domain name or IP address of the SIP Registrar server. The maximum is 63 characters.                                                                                                                                           |
| <i>-y [proxy]</i>                                      | Set domain name or IP address of SIP proxy server. The maximum is 63 characters.                                                                                                                                                       |
| <i>-b [enable]</i>                                     | Enable / disable outbound proxy by SIP account.<br>0 - disable<br>1 - enable                                                                                                                                                           |
| <i>-s [enable]</i>                                     | Enable / disable to locate SIP server (rfc 3263).<br>0 - disable<br>1 - enable                                                                                                                                                         |
| <i>-N [name]</i>                                       | Set SIP account display name.<br>Name - max. 23 characters.                                                                                                                                                                            |
| <i>-n [number]</i>                                     | Set SIP account number.<br>Number - max. 63 characters.                                                                                                                                                                                |
| <i>-a [id]</i>                                         | Set SIP authentication ID.<br>Id - max. 63 characters.                                                                                                                                                                                 |
| <i>-A [enable]</i>                                     | Enable /disable to use SIP authentication ID.<br>0 - disable<br>1 - enable                                                                                                                                                             |
| <i>-p [passwd]</i>                                     | Set SIP account password (max. 63 characters).                                                                                                                                                                                         |
| <i>-e [sec]</i>                                        | Set expiry time (default 3600) for SIP account.                                                                                                                                                                                        |
| <i>-w [enable]</i>                                     | Enable to make phone call without registering.                                                                                                                                                                                         |
| <i>-m [mode]</i>                                       | Set NAT traversal mode.<br>0 - disable<br>1 - stun<br>2 - manual<br>3 - nortel                                                                                                                                                         |
| <i>-F [mode]</i>                                       | Set call forwarding mode.<br>0 - disable<br>1 - always                                                                                                                                                                                 |

|                    |                                                                                                                |
|--------------------|----------------------------------------------------------------------------------------------------------------|
|                    | 2 - busy<br>3 - no answer<br>4 - busy or no answer                                                             |
| -u [url]           | Set SIP URL for call forwarding (max. 63 characters).                                                          |
| -t [sec]           | Set call forwarding timer. For example,<br>voip sip acc 1 -t 30                                                |
| -g [port]          | Set the ring port for incoming call. For example,<br>Port - r1 means FXS1; r2 means FXS2.                      |
| -z [pattern]       | Set account ring pattern (1 - 6).                                                                              |
| -i [enable]        | Remove all bindings while they are un-registered. 0 means Disable;<br>and 1 means Enable.                      |
| -B <enable>        | Enable / disable the function of Broadsoft Call Control.<br>0 - disable<br>1 - enable                          |
| -S [idx]           | Enable and use alias IP to register.<br>idx - 1 to 31. If 0 is used, such function will be disabled.           |
| -k [num1 num2...]  | Set backup wan list (first wan, second wan...).<br>range: 1 to 4.                                              |
| -v                 | View current status for account settings.                                                                      |
| <b>voip alias</b>  |                                                                                                                |
| n                  | n = 1 to 30                                                                                                    |
| -e <enable>        | Enable or disable this alias profile.<br>0:Disable.<br>1:Enable.                                               |
| -a <username>      | Set the alias name (max 23 characters).                                                                        |
| -n <number>        | Set the alias number (max 63 characters).                                                                      |
| -t <account idx>   | Set the alias of SIP account. (range: 1-12)                                                                    |
| -v <idx>           | show alias list information.                                                                                   |
| voip sip calllog   | Display current status for SIP call log.                                                                       |
| <b>voip sip ep</b> |                                                                                                                |
| n                  | The index number of the VoIP settings.<br>n - 1, 2.                                                            |
| -o [acc]           | Available dial out account (1 - 12).                                                                           |
| -L [url]           | Set SIP URL (max. 63 characters) for hot line.                                                                 |
| -l [enable]        | Enable / disable the function of hot line.<br>0 - disable<br>1 - enable                                        |
| -W [enable]        | Enable / disable the function of warm line.<br>0 - disable<br>1 - enable                                       |
| -w [enable]        | Enable / disable the function of call waiting enable.<br>0 - disable<br>1 - enable                             |
| -E [enable]        | Enable / disable the function of call waiting enable but only remind<br>one time.<br>0 - disable<br>1 - enable |
| -x <enable>        | Enable / disable the function of call transfer.                                                                |

|                                                                                   |                                                                                                               |
|-----------------------------------------------------------------------------------|---------------------------------------------------------------------------------------------------------------|
|                                                                                   | 0 - disable<br>1 - enable                                                                                     |
| <i>-d [enable]</i>                                                                | Enable / disable the function of DND (Do Not Disturb)<br>0 - disable<br>1 - enable                            |
| <i>-s [id]</i>                                                                    | Indicate DND schedule.<br>Id - s1, s2, s3, s4 (max. 4 schedule)                                               |
| <i>-h [enable]</i>                                                                | Enable / disable the function of calling line identification restriction (CLIR).<br>0 - disable<br>1 - enable |
| <i>-u [mode]</i>                                                                  | Set CLIR mode.<br>0 - means "draft-ietf-sip-privacy"<br>1 - means "rfc 3323/3325"                             |
| <i>-z [enable]</i>                                                                | Enable / disable playing dial tone when registered on sip server.<br>0 - disable<br>1 - enable                |
| <i>-n [enable]</i>                                                                | Enable / disable session timer.<br>0 - disable<br>1 - enable                                                  |
| <i>-m [sec]</i>                                                                   | Set the value for session timer (unit: sec).                                                                  |
| <i>-R [min,max]</i>                                                               | Set the flash hook time range 100-2000 (unit: ms).                                                            |
| <i>-8 [enable]</i>                                                                | Enable or disable T.38 fax relay feature.<br>0 - disable<br>1 - enable                                        |
| <i>-v</i>                                                                         | View current settings.                                                                                        |
| <b>voip sip misc</b> - Allows users to set miscellaneous settings for the device. |                                                                                                               |
| <i>-c [enable]</i>                                                                | Enable compact header to shorten the packet (0: disable, 1: enable).                                          |
| <i>-s [enable]</i>                                                                | Change "#" into digit number.<br>0 - disable<br>1 - enable                                                    |
| <i>-e [enable]</i>                                                                | Enable Europe style flash hook operation mode.<br>0 - disable<br>1 - enable                                   |
| <i>-h [enable]</i>                                                                | Enable/disable call hold mode based on protocol RFC2543 (0: disable, 1:enable).                               |
| <i>-i [enable]</i>                                                                | Enable CODEC change without Re-INVITE.<br>0 - disable<br>1 - enable                                           |
| <i>-p [enable]</i>                                                                | Enable PRACK message.<br>0 - Not support PRACK.<br>1 - Support PRACK.                                         |
| <i>-P [enable]</i>                                                                | Enable IP Call.<br>0 - Disable IP call.<br>1 - Enable IP call.                                                |
| <i>-H [enable]</i>                                                                | SIP INFO packet will be sent out when encountering hook flash event.<br>0 - disable<br>1 - enable             |
| <i>-t [val]</i>                                                                   | Set the mode of User-Agent (e.g., phone, software, and device) for SIP packet.                                |

|                                                                  |                                                                                                                                                                                                                             |
|------------------------------------------------------------------|-----------------------------------------------------------------------------------------------------------------------------------------------------------------------------------------------------------------------------|
|                                                                  | 0 - Hide SIP header "User-Agent".<br>1 - Show SIP header "User-Agent".<br>2 - Use default "User-Agent" value.<br>3 - Use user-defined "User-Agent" value.                                                                   |
| <i>-u UAValue</i>                                                | For every SIP user agent identifies itself with a string, this command allows you to set the value (e.g, IP address, phone number, e-mail address) of User-Agent. The length of the string must be less than 64 characters. |
| <i>-D [disable]</i>                                              | Disable VoIP Service.<br>1 - disable VoIP service.<br>0 - enable VoIP service.<br>System will automatic reboot to activate voip service                                                                                     |
| <i>-v</i>                                                        | View current status for miscellaneous settings.                                                                                                                                                                             |
| <i>voip sip nat</i> - Allows users to set NAT Traversal Setting. |                                                                                                                                                                                                                             |
| <i>-s [server]</i>                                               | Set the IP address for STUN server.                                                                                                                                                                                         |
| <i>-t [sec]</i>                                                  | Set ping interval for SIP account.<br>Sec - 6 - 600                                                                                                                                                                         |
| <i>-i [ip]</i>                                                   | Indicate external IP address.                                                                                                                                                                                               |
| <i>-v</i>                                                        | View current settings for SIP NAT.                                                                                                                                                                                          |

## Example

```

> voip sip misc -t 1
includes User-Agent header

> voip sip misc -u 91704688carrie
user-defined User-Agent:91704688carrie
> voip sip acc 1 -P carrie_1 -r 1 -d 172.16.3.133
> voip sip acc 1 -t 30
> voip sip misc -h 1
> voip sip acc 1 -v
index          : 1
profile        : carrie_1
reg mode       : 1 | reg. [No]
alias_ip_idx   : 0
backup list    :
domain         : 172.16.3.133
proxy          : | outbound [No] | DNS-SRV [No]
noreg call     : No
disp. Name     :
acc number     : ---
auth. ID       : | [disable]
expiry         : 3600
NAT mode       : 0
ring ports     : 0
ring pat.      : 1
call fwd mode  : 0
call fwd url   :
call fwd timer : 30
Broadsoft      : disable
Italian ITSP modification: disable

```

## Telnet Command: voip secure

This command allows users to enable or disable secure phone feature, and SAS voice prompt.

## Syntax

voip secure general [-<command> <parameter> | ... ]

## Syntax Description

| Parameter | Description                                                         |
|-----------|---------------------------------------------------------------------|
| -e <0/1>  | Enable / disable secure phone feature.<br>0 - disable<br>1 - enable |
| -p <0/1>  | Enable /disable SAS voice prompt.<br>0 - disable<br>1 - enable      |
| -v        | view only secure phone general settings                             |

## Example

```
> voip secure general -v
secure phone feature is disabled
SAS voice prompt is enabled
> voip secure general -p 0
SAS voice prompt is disabled
```

## Telnet Command: vlan group

This command allows you to set VLAN group. You can set four VLAN groups. Please run *vlan restart* command after you change any settings.

## Syntax

vlan group *id* <set/set\_ex> <p1/p2/p3/p4/p5/s1/s2/s3/s4/5gs1/5gs2/5gs3/5gs4>

## Syntax Description

| Parameter                  | Description                                                                                                                                       |
|----------------------------|---------------------------------------------------------------------------------------------------------------------------------------------------|
| <i>id</i>                  | It means the group 0 to 7 for VLAN.                                                                                                               |
| <i>set</i>                 | It indicates each port can join more than one VLAN group.                                                                                         |
| <i>set_ex</i>              | It indicates each port can join one VLAN group at one time.                                                                                       |
| <i>p1/p2/p3/p4/p5</i>      | It indicates LAN port 1 to LAN port 5. To group LAN1, LAN2, LAN3, LAN4 and/or LAN5 under one VLAN group, please type the port number(s) you want. |
| <i>s1/s2/s3/s4</i>         | It is only available for WALN models.                                                                                                             |
| <i>5gs1/5gs2/5gs3/5gs4</i> | It is only available for WALN n plus models.                                                                                                      |

## Example

```
> vlan group 3 set p1 s3 s4
VLAN  p1  p2  p3  p4  s1  s2  s3  s4  5gs1  5gs2  5gs3  5gs4
-----
  3    V                               V  V
>
```

## Telnet Command: vlan off

This command allows you to disable VLAN function.

## Syntax

vlan off

## Example

```
> vlan off
VLAN is Disable!
Force subnet LAN2/3/4/5/6/7/8/9/10/11/12/13/14/15/16 to be disabled!!
```

## Telnet Command: vlan on

This command allows you to enable VLAN function.

## Syntax

vlan on

## Example

```
> vlan on
VLAN is Enable!
```

## Telnet Command: vlan pri

This command is used to define the priority for each VLAN profile setting.

## Syntax

vlan pri *n pri\_no*

## Syntax Description

| Parameter     | Description                                                                            |
|---------------|----------------------------------------------------------------------------------------|
| <i>n</i>      | It means VLAN ID number.<br>n=VLAN ID number (from 0 to 7).                            |
| <i>pri_no</i> | It means the priority of VLAN profile.<br>pri_no=0 ~7 (from none to highest priority). |

## Example

```
> vlan pri 1 2
VLAN1: Priority=2
```

## Telnet Command: vlan restart

This command can make VLAN settings restarted with newest configuration.

## Syntax

vlan restart

## Example

```
> vlan restart ?
VLAN restarts!!!
```

## Telnet Command: vlan status

This command display current status for VLAN.

## Syntax



## vlan status

### Example

```
> vlan status
VLAN is Disable :
-----
VLAN Enable VID Pri p1 p2 p3 p4 p5 s1 s2 s3 s4 5gs1 5gs2 5gs3 5gs4 subnet
-----
0 OFF 0 0 2:LAN2
1 OFF 0 0 1:LAN1
2 OFF 0 0 1:LAN1
3 OFF 0 0 V V 1:LAN1
4 OFF 0 0 1:LAN1
5 OFF 0 0 1:LAN1
6 OFF 0 0 1:LAN1
7 OFF 0 0 1:LAN1
8 OFF 0 0 1:LAN1
9 OFF 0 0 1:LAN1
10 OFF 0 0 1:LAN1
11 OFF 0 0 1:LAN1
12 OFF 0 0 1:LAN1
13 OFF 0 0 1:LAN1
14 OFF 0 0 1:LAN1
15 OFF 0 0 1:LAN1
-----
Note: they are only untag for s1/s2/s3/s4/5gs1/5gs2/5gs3/5gs4, but they can
join tag vlan with lan ports.
Permit untagged device in P1 to access router: ON....
```

### Telnet Command: vlan subnet

This command is used to configure the LAN interface used by the VLAN group.

#### Syntax

vlan subnet group\_id <1/2/3/4/5/6/7/8>

#### Syntax Description

| Parameter         | Description                       |
|-------------------|-----------------------------------|
| <1/2/3/4/5/6/7/8> | It means interfaces, LAN1 - LAN8. |

### Example

```
> vlan subnet group_id 2
% Vlan Group-0 using LAN2 !

This setting will take effect after rebooting.
Please use "sys reboot" command to reboot the router.
```

### Telnet Command: vlan submode

This command changes the VLAN encapsulation mechanisms in the LAN driver.

## Syntax

vlan submode <on/off/status>

## Syntax Description

| Parameter     | Description                                                        |
|---------------|--------------------------------------------------------------------|
| <i>on</i>     | It means to enable the promiscuous mode.                           |
| <i>off</i>    | It means to enable the normal mode.                                |
| <i>status</i> | It means to display if submode is normal mode or promiscuous mode. |

## Example

```
> vlan submode status
% vlan subnet mode : normal mode
> vlan submode on
% vlan subnet mode modified to promiscuous mode.
> vlan submode status
% vlan subnet mode : promiscuous mode
```

## Telnet Command: vlan tagged

This command is used to enable or disable the incoming of untagged packets.

## Syntax

vlan tagged <n> <on/off>  
vlan tagged <unlimited> <on/off>  
vlan tagged <p1\_untag> <on/off>

## Syntax Description

| Parameter            | Description                                                                                                                                                   |
|----------------------|---------------------------------------------------------------------------------------------------------------------------------------------------------------|
| <n>                  | It means VLAN number.<br>The range is from 0 to 15.                                                                                                           |
| <on/off>             | It means to enable/disable the tagged VLAN.                                                                                                                   |
| <unlimited> <on/off> | unlimited on: It allows the incoming of untagged packets even all VLAN are tagged.<br>unlimited off: It does not allows the incoming of untagged packets.     |
| <p1_untag> <on/off>  | P1_untag on: It allows the incoming of untagged packets form LAN port 1.<br>P1_untag off: It does not allow the incoming of untagged packets from LAN port 1. |

## Example

```
> vlan tagged unlimited on
Unlimited mode is ON
>
```

## Telnet Command: vlan vid

This command is used to configure VID number for each VLAN channel.

## Syntax

vlan vid <n> <vid\_no>

## Syntax Description

| Parameter             | Description                                                                                       |
|-----------------------|---------------------------------------------------------------------------------------------------|
| <i>&lt;n&gt;</i>      | It means VLAN channel.<br>The range is from 0 to 7.                                               |
| <i>&lt;vid_no&gt;</i> | It means the value of VLAN ID. Type the value as the VLAN ID number. The range is form 0 to 4095. |

## Example

```
> vlan vid 1 4095
VLAN1, vid=4095
```

## Telnet Command: vlan sysvid

This command is used to modify and show the scope (reserved 78) of the VLAN IDs used internally by the system.

### Syntax

vlan sysvid *<show / n>*

### Syntax Description

| Parameter   | Description                                                              |
|-------------|--------------------------------------------------------------------------|
| <i>show</i> | It means to show the scope of VLAN ID used internally.                   |
| <i>n</i>    | It means the value to be set as VLAN ID.<br>The range is from 0 to 3980. |

## Example

```
> vlan sysvid 100
You have set system VLAN ID to range: 100 ~ 215,
We recommend that you reboot the system now.

> vlan sysvid 200
You have set system VLAN ID to range: 200 ~ 315,
We recommend that you reboot the system now.

> vlan sysvid show
The system VLAN ID is in range: 200 ~ 263
```

## Telnet Command: vpn l2lset

This command allows users to set advanced parameters for LAN to LAN function.

### Syntax

```
vpn l2lset <list index> peerid <peerid>
vpn l2lset <list index> localid <localid>
vpn l2lset <list index> main <auto/proposal index>
vpn l2lset <list index> aggressive <desg1/desg2/aesg1/aesg2/aesg5/aesg14>
vpn l2lset <list index> pfs <on/off>
vpn l2lset <list index> phase1 <lifetime>
vpn l2lset <list index> phase2 <lifetime>
vpn l2lset <list index> x509localid <0/1>
vpn l2lset <list index> compress <0/1/2/3>
```

## Syntax Description

| Parameter                                                      | Description                                                                                                                                                                                                                                                                                                                                            |
|----------------------------------------------------------------|--------------------------------------------------------------------------------------------------------------------------------------------------------------------------------------------------------------------------------------------------------------------------------------------------------------------------------------------------------|
| <i>&lt;list index&gt;</i>                                      | It means the index number of L2L (LAN to LAN) profile.                                                                                                                                                                                                                                                                                                 |
| <i>peerid &lt;peerid&gt;</i>                                   | It means the peer identity for aggressive mode.                                                                                                                                                                                                                                                                                                        |
| <i>localid &lt;localid&gt;</i>                                 | It means the local identity for aggressive mode.                                                                                                                                                                                                                                                                                                       |
| <i>main &lt;auto/proposal index&gt;</i>                        | It means to choose proposal for main mode.<br><auto>: Choose default proposals.<br><proposal index>: choose specified proposal.                                                                                                                                                                                                                        |
| <i>aggressive &lt;desg1/desg2/aesg1/aesg2/aesg5/aesg14&gt;</i> | It means the chosen DH group for aggressive mode.                                                                                                                                                                                                                                                                                                      |
| <i>pfs &lt;on/off&gt;</i>                                      | It means "perfect forward secrete".<br><on/off>: Turn on or off the PFS function.                                                                                                                                                                                                                                                                      |
| <i>phase1 &lt;lifetime&gt; / phase2 &lt;lifetime&gt;</i>       | It means phase 1 or 2 of IKE.<br><lifetime>: Set the lifetime value (in second) for phase 1 and phase 2.                                                                                                                                                                                                                                               |
| <i>x509localid &lt;0/1&gt;</i>                                 | It means to enable (1) or disable (0) the X509 local ID.                                                                                                                                                                                                                                                                                               |
| <i>compress &lt;0/1/2/3&gt;</i>                                | Select a method to compress the packets to reduce the bandwidth usage while transferring the compressed packets.<br><0/1/2/3> - Available values are:<br>0 : Disable the function of compression.<br>1 : No . Use the Adaptive method for packet compression.<br>2 : LZ4. Use the algorithm of LZ4 for packet compression.<br>3 : LZ0. For future use. |

## Example

```
> VPN l2lset 1 peerid 10226
```

## Telnet Command: vpn l2IDrop

This command allows users to terminate current LAN to LAN VPN connection.

### Syntax

```
vpn l2IDrop l2lname <name>
vpn l2IDrop l2lidx <idx>
vpn l2IDrop h2lname <name>
vpn l2IDrop h2lidx <idx>
vpn l2IDrop <ifno>
vpn l2IDrop
```

### Syntax Description

| Parameter                   | Description                                                                                        |
|-----------------------------|----------------------------------------------------------------------------------------------------|
| <i>l2lname &lt;name&gt;</i> | It means to drop VPN connection by specifying the name of the LAN to LAN profile.                  |
| <i>l2lidx &lt;idx&gt;</i>   | It means to drop VPN connection by specifying the index number of LAN to LAN profile.              |
| <i>h2lname &lt;name&gt;</i> | It means to drop VPN connection by specifying the name of the remote dial-in user profile.         |
| <i>h2lidx &lt;idx&gt;</i>   | It means to drop VPN connection by specifying the index number of the remote dial-in user profile. |

|                     |                                                    |
|---------------------|----------------------------------------------------|
| <i>&lt;ifno&gt;</i> | It means to drop VPN connection by using VPN ifno. |
| <i>l2lDrop</i>      | It means to drop all VPN connections.              |

### Example

```
> vpn l2lDrop
Drop all VPN
```

## Telnet Command: vpn l2lDialout

This command allows users to terminate current LAN to LAN VPN connection (dial-out).

### Syntax

```
vpn l2lDialout <idx>
vpn l2lDialout list
```

### Syntax Description

| Parameter                     | Description                                                                                                                                |
|-------------------------------|--------------------------------------------------------------------------------------------------------------------------------------------|
| <i>l2lDialout &lt;idx&gt;</i> | It means to build VPN connection by specifying the index number of dial-out LAN to LAN profile.<br><idx>: Enter an index number (1 to 64). |
| <i>list</i>                   | It means to display LAN to LAN profiles (enabled).                                                                                         |

### Example

```
> vpn l2lDialout list
List LAN to LAN profiles of the status as Enable
Index Profile Status
```

## Telnet Command: vpn dinset

This command allows users to configure setting for remote dial-in VPN profile.

### Syntax

```
vpn dinset <list index>
vpn dinset <list index> <on/off>
vpn dinset <list index> username <USERNAME>
vpn dinset <list index> password <PASSWORD>
vpn dinset <list index> motp <on/off>
vpn dinset <list index> pin_secret <pin> <secret>
vpn dinset <list index> timeout <0-9999>
vpn dinset <list index> dintype <Type> <on/off>
vpn dinset <list index> subnet <0-8>
vpn dinset <list index> assignip <on/off>
vpn dinset <list index> srnode <on/off>
vpn dinset <list index> remoteip <Remote_Client_IP_Address>
vpn dinset <list index> peer <Peer_ID>
vpn dinset <list index> naming <pass/block>
vpn dinset <list index> multicastvpn <pass/block>
vpn dinset <list index> prekey <on/off>
vpn dinset <list index> assignkey <Pre_Shared_Key>
```

vpn dinset <list index> digsig <on/off>  
 vpn dinset <list index> ipsec <Method> <on/off>  
 vpn dinset <list index> localid <Local\_ID>

## Syntax Description

| Parameter                                    | Description                                                                                                                                                                                                                                                                                                                             |
|----------------------------------------------|-----------------------------------------------------------------------------------------------------------------------------------------------------------------------------------------------------------------------------------------------------------------------------------------------------------------------------------------|
| <list index>                                 | It means the index number of the profile.                                                                                                                                                                                                                                                                                               |
| <list index> <on/off>                        | It means to enable or disable the profile.<br><list index> - Enter the index number of the VPN profile.<br><on/off> - on: Enable; off: Disable.                                                                                                                                                                                         |
| <list index> motp <on/off>                   | It means to enable or disable the authentication with mOTP function.<br><list index> - Enter the index number of the VPN profile.<br><on/off> - on: Enable; off: Disable.                                                                                                                                                               |
| <list index> pin_secret <pin><br><secret>    | It means to set PIN code with secret.<br><list index> - Enter the index number of the VPN profile.<br><pin> - Type the code for authentication (e.g, 1234).<br><secret> - Use the 32 digit-secret number generated by mOTP in the mobile phone (e.g., e759bb6f0e94c7ab4fe6)                                                             |
| <list index> timeout<br><0-9999>             | It means to set idle timeout. The default is 300 (seconds).<br><list index> - Enter the index number of the VPN profile.<br><0-9999> - Enter a value.                                                                                                                                                                                   |
| <list index> dintype <Type><br><on/off>      | It means to enable/disable the allowed dial-in type.<br><list index> - Enter the index number of the VPN profile.<br><Type> - 0 to 3. In which,<br>0 means PPTP;<br>1 means IPsec Tunnel;<br>2 means L2TP with IPsec Policy;<br>3 means SSL Tunnel.<br><on/off> - on: Enable; off: Disable.                                             |
| vpn dinset <list index><br>subnet <0-8>      | It means to set the LAN subnet for the selected VPN profile.<br><list index> - Enter the index number of the VPN profile.<br><0-8> - Enter a number to specify the LAN subnet. In which,<br>0 means LAN1<br>1 means LAN2<br>2 means LAN3<br>3 means LAN4<br>4 means LAN5<br>5 means LAN6<br>6 means LAN7<br>7 means LAN8<br>8 means DMZ |
| vpn dinset <list index><br>assignip <on/off> | It means to enable or disable the function of assigning the static IP address.<br><list index> - Enter the index number of the VPN profile.<br><on/off> - on: Enable; off: Disable.                                                                                                                                                     |
| vpn dinset <list index><br>srnode <on/off>   | It means to enable or disable the function of specifying the remote node.<br><list index> - Enter the index number of the VPN profile.<br><on/off> - on: Enable; off: Disable.                                                                                                                                                          |
| vpn dinset <list index><br>remoteip          | It means to enable or disable the function of assigning remote client IP.                                                                                                                                                                                                                                                               |

|                                                                          |                                                                                                                                                                                                                                                                                                                                 |
|--------------------------------------------------------------------------|---------------------------------------------------------------------------------------------------------------------------------------------------------------------------------------------------------------------------------------------------------------------------------------------------------------------------------|
| <i>&lt;Remote_Client_IP_Address&gt;</i><br>>                             | <list index> - Enter the index number of the VPN profile.<br><Remote_Client_IP_Address> - Set the IP address of the remote client.                                                                                                                                                                                              |
| <i>vpn dinset &lt;list index&gt; peer &lt;Peer_ID&gt;</i>                | It means to assign the peer ID.<br><list index> - Enter the index number of the VPN profile.<br><Peer_ID> - Enter the string of the peer ID.                                                                                                                                                                                    |
| <i>vpn dinset &lt;list index&gt; naming &lt;pass/block&gt;</i>           | It means to set the Netbiid Naming Packet for the VPN profile.<br><list index> - Enter the index number of the VPN profile.<br><pass/block> - Let the packet pass or block the packet.                                                                                                                                          |
| <i>vpn dinset &lt;list index&gt; multicastvpn &lt;pass/block&gt;</i>     | It means to set the multicast via VPN for IGMP, IP-CAM, DHCP relay, and etc.<br><list index> - Enter the index number of the VPN profile.<br><pass/block> - Let the packet pass or block the packet.                                                                                                                            |
| <i>vpn dinset &lt;list index&gt; prekey &lt;on/off&gt;</i>               | It means to enable/disable the Pre-Shared Key setting for IKE Authentication Method.<br><list index> - Enter the index number of the VPN profile.<br><on/off> - on: Enable; off: Disable.                                                                                                                                       |
| <i>vpn dinset &lt;list index&gt; assignkey &lt;Pre_Shared_Key&gt;</i>    | It means to set the Pre-Shared Key for IKE Authentication Method.<br><list index> - Enter the index number of the VPN profile.<br><Pre_Shared_Key> - Enter a string as PSK.                                                                                                                                                     |
| <i>vpn dinset &lt;list index&gt; digsig &lt;on/off&gt;</i>               | It means to enable/disable the digital signature (X.509) for IKE Authentication Method.<br><list index> - Enter the index number of the VPN profile.<br><on/off> - on: Enable; off: Disable.                                                                                                                                    |
| <i>vpn dinset &lt;list index&gt; ipsec &lt;Method&gt; &lt;on/off&gt;</i> | It means to enable / disable and set the protocol for IPsec security method.<br><list index> - Enter the index number of the VPN profile.<br><Method> - Enter a number (0 to 3) to specify the protocol.<br>0 means Medium(AH) High(ESP),<br>1 means DES<br>2 means 3DES<br>3 means AES<br><on/off> - on: Enable; off: Disable. |
| <i>vpn dinset &lt;list index&gt; localid &lt;Local_ID&gt;</i>            | It means to set local ID (optional) for IPsec Security Method.<br><list index> - Enter the index number of the VPN profile.<br><local_ID> - Enter the string of local ID.                                                                                                                                                       |

## Example

```

> vpn dinset 1
Dial-in profile index 1
Profile Name: ???
Status: Deactive
Mobile OTP: Disabled
Password:
Idle Timeout: 300 sec
> vpn dinset 1 on
% set profile active
> vpn dinset 1 motp on
% Enable Mobile OTP mode!>
> vpn dinset 1 pin_secret 1234 e759bb6f0e94c7ab4fe6
> vpn dinset 1
Dial-in profile index 1
Profile Name: ???

```

```
Status: Active
Mobile OTP: Enabled
PIN: 1234
Secret: e759bb6f0e94c7ab4fe6
Idle Timeout: 300 sec
```

## Telnet Command: vpn subnet

This command allows users to specify a subnet selection for the specified remote dial-in VPN profile.

### Syntax

```
vpn subnet <index><1/2/3/4/5/6/7/8>
```

### Syntax Description

| Parameter         | Description                                                                                                                                                               |
|-------------------|---------------------------------------------------------------------------------------------------------------------------------------------------------------------------|
| <index>           | It means the index number of the VPN profile.                                                                                                                             |
| <1/2/3/4/5/6/7/8> | 1 - it means LAN1<br>2 - it means LAN2.<br>3 - it means LAN3<br>4 - it means LAN4.<br>5 - it means LAN5<br>6 - it means LAN6.<br>7 - it means LAN7.<br>8 - it means LAN8. |

### Example

```
> vpn subnet 1 2
>
```

## Telnet Command: vpn setup

This command allows users to setup VPN for different types.

### Syntax

Command of PPTP Dial-Out

```
vpn setup <index> <name> pptp_out <ip> <usr> <pwd> <nip> <nmask>
```

Command of IPSec Dial-Out

```
vpn setup <index> <name> ipsec_out <ip> <key> <nip> <nmask>
```

Command of L2Tp Dial-Out

```
vpn setup <index> <name> l2tp_out <ip> <usr> <pwd> <nip> <nmask>
```

Command of Dial-In

```
vpn setup <index> <name> dialin <ip> <usr> <pwd> <key> <nip> <nmask>
```

Command of 6in4

```
vpn setup <index> <name> 6in4 <enable> <lan> <rem_lan_ip> <lan_pfx>
<pfx_len><rem_pfx> <pre_len> <ttl>
```

### Syntax Description

| Parameter | Description |
|-----------|-------------|
|-----------|-------------|



| For PPTP Dial-Out  |                                                                                                                                    |
|--------------------|------------------------------------------------------------------------------------------------------------------------------------|
| <index>            | It means the index number of the profile.                                                                                          |
| <name>             | It means the name of the profile.                                                                                                  |
| <ip>               | It means the IP address to dial to.                                                                                                |
| <usr> <pwd>        | It means the user and the password required for the PPTP connection.                                                               |
| <nip> <nmask>      | It means the remote network IP and the mask.<br>e.g.,<br>vpn setup 1 name1 pptp_out 1.2.3.4 vigor 1234 192.168.1.0 255.255.255.0   |
| For IPsec Dial-Out |                                                                                                                                    |
| <index>            | It means the index number of the profile.                                                                                          |
| <name>             | It means the name of the profile.                                                                                                  |
| <ip>               | It means the IP address to dial to.                                                                                                |
| <key>              | It means the value of IPsec Pre-Shared Key.                                                                                        |
| <nip> <nmask>      | It means the remote network IP and the mask.<br>e.g.,<br>vpn setup 1 name1 ipsec_out 1.2.3.4 1234 192.168.1.0 255.255.255.0        |
| For L2TP Dial-Out  |                                                                                                                                    |
| <index>            | It means the index number of the profile.                                                                                          |
| <name>             | It means the name of the profile.                                                                                                  |
| <ip>               | It means the IP address to dial to.                                                                                                |
| <usr> <pwd>        | It means the user and the password required for the L2TP connection.                                                               |
| <nip> <nmask>      | It means the remote network IP and the mask.<br>e.g.,,<br>vpn setup 1 name1 l2tp_out 1.2.3.4 vigor 1234 192.168.1.0 255.255.255.0  |
| For Dial-In        |                                                                                                                                    |
| <index>            | It means the index number of the profile.                                                                                          |
| <name>             | It means the name of the profile.                                                                                                  |
| <ip>               | It means the IP address allowed to dial in.                                                                                        |
| <usr> <pwd>        | It means the user and the password required for the PPTP/L2TP connection.                                                          |
| <key>              | It means the value of IPsec Pre-Shared Key.                                                                                        |
| <nip> <nmask>      | It means the remote network IP and the mask.<br>e.g.,<br>vpn setup 1 name1 dialin 1.2.3.4 vigor 1234 abc 192.168.1.0 255.255.255.0 |
| For 6in4           |                                                                                                                                    |
| <index>            | It means the index number of the profile.                                                                                          |
| <name>             | It means the name of the profile.                                                                                                  |
| <enable>           | It means to enable (1) or disable (0) the profile.                                                                                 |
| <lan>              | Choose the LAN interface (0 to 16) or DMZ (17).                                                                                    |
| <rem_lan_ip>       | It means to specify the remote LAN IP address.                                                                                     |
| <lan_pfx>          | It means to set the LAN IPv6 prefix.                                                                                               |
| <pfx_len>          | It means to set the IPv6 prefix length (32 to 128).                                                                                |

|                        |                                                                                                                 |
|------------------------|-----------------------------------------------------------------------------------------------------------------|
| <i>&lt;rem_pfx&gt;</i> | It means to set remote IPv6 prefix.                                                                             |
| <i>&lt;pre_len&gt;</i> | It means to set remote IPv6 prefix length (32 to 128).                                                          |
| <i>&lt;ttl&gt;</i>     | It means to set the tunnel TTL (1 to 255).<br>Ex. vpn setup 1 name1 6in4 1 1 192.168.10.1 193:: 64 192:: 64 255 |

## Example

```
> vpn setup 1 name1 dialin 1.2.3.4 vigor 1234 abc 192.168.1.0 255.255.255.0
% Profile Change Log ...

% Profile Index : 1
% Profile Name : name1
% Username : vigor
% Password : 1234
% Pre-share Key : abc
% Call Direction : Dial-In
% Type of Server : ISDN PPTP IPsec L2TP
% Dial from : 1.2.3.4
% Remote Network IP : 192.168.1.0
% Remote Network Mask : 255.255.255.0
>
```

## Telnet Command: vpn option

This command allows users to configure settings for LAN to LAN profile.

### Syntax

vpn option *<index>* *<cmd1>*=*<param1>* [*<cmd2>*=*<para2>* | ... ]

### Syntax Description

| Parameter                  | Description                                                                                                                                                                                                                                                                                           |
|----------------------------|-------------------------------------------------------------------------------------------------------------------------------------------------------------------------------------------------------------------------------------------------------------------------------------------------------|
| <i>&lt;index&gt;</i>       | It means the index number of the profile.<br>Available index numbers:<br>1 - 32                                                                                                                                                                                                                       |
| <b>For Common Settings</b> |                                                                                                                                                                                                                                                                                                       |
| <i>&lt;index&gt;</i>       | It means the index number of the profile.                                                                                                                                                                                                                                                             |
| <i>pname</i>               | It means the name of the profile.                                                                                                                                                                                                                                                                     |
| <i>ena</i>                 | It means to enable or disable the profile.<br>on - Enable<br>off - Disable                                                                                                                                                                                                                            |
| <i>thr</i>                 | It means the way that VPN connection passes through. Available settings are wlf, wlo, w2f, w2o and ....<br>w1f - WAN1 First.<br>w1o - WAN1 Only.<br>w2f - WAN2 First.<br>w2o - WAN2 Only.<br>w1oB - WAN1 Only (Only establish VPN if WAN2 down)<br>w2oB - WAN2 Only (Only establish VPN if WAN1 down) |
| <i>thr_ai</i>              | It means connection through wan IP alias.<br>0 - do not use alias.<br>1/2/.../31 - Use the allias IP (index number 1 to 31).                                                                                                                                                                          |

|                              |                                                                                                                                                                                                                                                                                                                                                                                                                                                                                                                                                    |
|------------------------------|----------------------------------------------------------------------------------------------------------------------------------------------------------------------------------------------------------------------------------------------------------------------------------------------------------------------------------------------------------------------------------------------------------------------------------------------------------------------------------------------------------------------------------------------------|
| <i>npkt</i>                  | It means the NetBios Naming Packet.<br>on - Enable the function to pass the packet.<br>off - Disable the function to block the packet.                                                                                                                                                                                                                                                                                                                                                                                                             |
| <i>dir</i>                   | It means the call direction. Available settings are b, o and i.<br>b - Both<br>o - Dial-Out<br>i - Dial-In.                                                                                                                                                                                                                                                                                                                                                                                                                                        |
| <i>idle</i>                  | It means Always on and Idle Time out.<br>Available values include:<br>-1 - it means always on for dial-out.<br>0 - it means always on for dial-in.<br>Other numbers (e.g., idle=200, idle=300, idle=500) mean the router will be idle after the interval (seconds) configured here.                                                                                                                                                                                                                                                                |
| <i>palive</i>                | It means to enable PING to keep alive.<br>-1 - disable the function.<br>1,2,3,4 - Enable the function and PING IP 1.2.3.4 to keep alive.                                                                                                                                                                                                                                                                                                                                                                                                           |
| <i>monitor</i>               | It means to enable Quality Monitoring.<br>On - Turn on Quality Monitoring.<br>Off - Turn off Quality Monitoring.                                                                                                                                                                                                                                                                                                                                                                                                                                   |
| <b>For Dial-Out Settings</b> |                                                                                                                                                                                                                                                                                                                                                                                                                                                                                                                                                    |
| <i>ctype</i>                 | It means "Type of Server I am calling".<br>ctype=t means PPTP.<br>ctype=s means IPSec.<br>ctype= l means L2TP(IPSec Policy None).<br>ctype= l1 means L2TP(IPSec Policy Nice to Have).<br>ctype= l2 means L2TP(IPSec Policy Must).<br>ctype= c means SSL Tunnel<br>ctype=o [0/1/2/3/4/5] [0/1/2/3] means Openvpn TCP Tunnel[AES128/AES256/NONE/AES128_GCM/AES192_GCM/AES256_GCM] [SHA1/SHA256/NONE/SHA512]<br>ctype= u[0/1/2/3/4/5][0/1/2/3] means Openvpn UDP Tunnel[AES128/AES256/NONE/AES128_GCM/AES192_GCM/AES256_GCM][SHA1/SHA256/NONE/SHA512] |
| <i>dialto</i>                | It means Server IP/Host Name for VPN. (such as draytek.com or 123.45.67.89).                                                                                                                                                                                                                                                                                                                                                                                                                                                                       |
| <i>ltype</i>                 | It means Link Type.<br>"ltype=0" means "Disable".<br>"ltype=1" means "64kbps".<br>"ltype=2" means "128kbps".<br>"ltype=3" means "BOD".                                                                                                                                                                                                                                                                                                                                                                                                             |
| <i>oname</i>                 | It means Dial-Out Username.<br>"oname=admin" means to set Username = admin.                                                                                                                                                                                                                                                                                                                                                                                                                                                                        |
| <i>opwd</i>                  | It means Dial-Out Password<br>"opwd=1234" means to set Password = 1234.                                                                                                                                                                                                                                                                                                                                                                                                                                                                            |
| <i>pauth</i>                 | It means PPP Authentication.<br>"pauth=pc" means to set PPP Authentication = PAP&CHAP.<br>"pauth=p" means to set PPP Authentication = PAP Only                                                                                                                                                                                                                                                                                                                                                                                                     |
| <i>ovj</i>                   | It means VJ Compression.<br>"ovj=on/off" means to enable/disable VJ Compression.                                                                                                                                                                                                                                                                                                                                                                                                                                                                   |
| <i>okey</i>                  | It means IKE Pre-Shared Key.<br>"okey=abcd" means to set IKE Pre-Shared Key = abcd.                                                                                                                                                                                                                                                                                                                                                                                                                                                                |
| <i>ometh</i>                 | It means IPSec Security Method.                                                                                                                                                                                                                                                                                                                                                                                                                                                                                                                    |

|                             |                                                                                                                                                                                                                                                                                                                                                                                                                                                                                                                                                           |
|-----------------------------|-----------------------------------------------------------------------------------------------------------------------------------------------------------------------------------------------------------------------------------------------------------------------------------------------------------------------------------------------------------------------------------------------------------------------------------------------------------------------------------------------------------------------------------------------------------|
|                             | <p>“ometh=ah[a/s/S]” means AH auto/sha1/Sha2.</p> <p>“ometh=espd/espda[a/s/S/” means ESP DES without/with Authentication auto/sha1/Sha2</p> <p>“ometh=esp3/esp3a[a/s/S]/” means ESP 3DES without/with Authentication auto/sha1/Sha2</p> <p>“ometh= espaa[1/9/2]/espaa[a/s/S][1/9/2] ” means ESP AES[128/192/256] without/with Authentication auto/sha1/Sha2 (AES128/192/256).</p>                                                                                                                                                                         |
| <i>tls_auth</i>             | It means to Turn off/on tls-auth option.                                                                                                                                                                                                                                                                                                                                                                                                                                                                                                                  |
| <i>tls_auth_key</i>         | It means to set OpenVPN tls-auth option key.<br>tls-auth_key=<1/2/3> Enter the number to select the PSK.                                                                                                                                                                                                                                                                                                                                                                                                                                                  |
| <i>tls_key_show</i>         | It means to show the selected PSK.                                                                                                                                                                                                                                                                                                                                                                                                                                                                                                                        |
| <i>sch</i>                  | It means Index(1-15) in Schedule Setup.<br>sch=1,3,5,7 Set schedule 1->3->5->7                                                                                                                                                                                                                                                                                                                                                                                                                                                                            |
| <i>ikemode</i>              | It means IKE phase 1 mode.<br>ikemode=m, Main mode.<br>ikemode=a, Aggressive mode.                                                                                                                                                                                                                                                                                                                                                                                                                                                                        |
| <i>ikeid</i>                | It means IKE Local ID.<br>“ikeid=vigor” means Set Local ID = vigor.                                                                                                                                                                                                                                                                                                                                                                                                                                                                                       |
| <i>oport</i>                | It means OpenVPN Dial-Out Port.<br>oport=1194. Set OpenVPN Dial-Out Port = 1194                                                                                                                                                                                                                                                                                                                                                                                                                                                                           |
| <b>For Dial-In Settings</b> |                                                                                                                                                                                                                                                                                                                                                                                                                                                                                                                                                           |
| <i>itype</i>                | It means Allowed Dial-In Type. Available settings include:<br>“itype=t” means PPTP.<br>“itype=s” means IPSec.<br>“itype=L”means L2TP (None).<br>“itype=l1” means L2TP(Nice to Have).<br>“itype=l2” means L2TP(Must).<br>“itype=c” means SSL Tunnel<br>“itype=i” means Openvpn UDP/TCP<br>“itype=i[0/1/2][0/1/2]” means Tunnel[AES128/AES256/NONE][SHA1/SHA256/NONE]/<br>“itype=o[0/1/2][0/1/2]” means Openvpn TCP Tunnel[AES128/AES256/NONE][SHA1/SHA256/NONE]/<br>“itype=u[0/1/2][0/1/2]” means Openvpn UDP Tunnel[AES128/AES256/NONE][SHA1/SHA256/NONE] |
| <i>peer</i>                 | It means specify Peer VPN Server IP for Remote VPN Gateway.<br>Type “203.12.23.48” means to allow VPN dial-in with IP address of 203.12.23.48.<br>Type “off” means any remote IP is allowed to dial in.                                                                                                                                                                                                                                                                                                                                                   |
| <i>peerid</i>               | It means the peer ID for Remote VPN Gateway.<br>Type “draytek” means the word is used as local ID.                                                                                                                                                                                                                                                                                                                                                                                                                                                        |
| <i>iname</i>                | It means Dial-in Username.<br>“iname=admin” means to set username as “admin”.                                                                                                                                                                                                                                                                                                                                                                                                                                                                             |
| <i>ipwd</i>                 | It means Dial-in Password.<br>“ipwd=1234” means to set password as “1234”.                                                                                                                                                                                                                                                                                                                                                                                                                                                                                |
| <i>ivj</i>                  | It means VJ Compression.<br>“ivj=on/off” means to enable /disable VJ Compression.                                                                                                                                                                                                                                                                                                                                                                                                                                                                         |
| <i>ikey</i>                 | It means IKE Pre-Shared Key.<br>“ikey=abcd” means to set IKE Pre-Shared Key = abcd.                                                                                                                                                                                                                                                                                                                                                                                                                                                                       |
| <i>imeth</i>                | It means IPSec Security Method                                                                                                                                                                                                                                                                                                                                                                                                                                                                                                                            |

|                            |                                                                                                                                                                                                                                                   |
|----------------------------|---------------------------------------------------------------------------------------------------------------------------------------------------------------------------------------------------------------------------------------------------|
|                            | <p>“imeth=h” means “Allow AH”.</p> <p>“imeth=d” means “Allow DES”.</p> <p>“imeth=3” means “Allow 3DES”.</p> <p>“imeth=a” means “Allow AES”.</p>                                                                                                   |
| <b>For TCP/IP Settings</b> |                                                                                                                                                                                                                                                   |
| <i>mywip</i>               | <p>It means My WAN IP.</p> <p>“mywip=1.2.3.4” means to set My WAN IP as “1.2.3.4”.</p>                                                                                                                                                            |
| <i>rgip</i>                | <p>It means Remote Gateway IP.</p> <p>“rgip=1.2.3.4” means to set Remote Gateway IP as “1.2.3.4”.</p>                                                                                                                                             |
| <i>rnip</i>                | <p>It means Remote Network IP.</p> <p>“rnip=1.2.3.0” means to set Remote Network IP as “1.2.3.0”.</p>                                                                                                                                             |
| <i>rnmask</i>              | <p>It means Remote Network Mask.</p> <p>“rnmask=255.255.255.0” means to set Remote Network Mask as “255.255.255.0”.</p>                                                                                                                           |
| <i>lnip</i>                | <p>It means Local Network IP.</p> <p>“lnip=1.2.3.0” means to set Local Network IP as “1.2.3.0”.</p>                                                                                                                                               |
| <i>lnmask</i>              | <p>It means Local Network Mask.</p> <p>“lnmask=255.255.255.0” means to set Local Network Mask as “255.255.255.0”.</p>                                                                                                                             |
| <i>rip</i>                 | <p>It means RIP Direction.</p> <p>“rip=d” means to set RIP Direction as “Disable”.</p> <p>“rip=t” means to set RIP Direction as “TX”.</p> <p>“rip=r” means to set RIP Direction as “RX”.</p> <p>“rip=b” means to set RIP Direction as “Both”.</p> |
| <i>mode</i>                | <p>It means the option of “From first subnet to remote network, you have to do”.</p> <p>“mode=r” means to set Route mode.</p> <p>“mode=n” means to set NAT mode.</p>                                                                              |
| <i>droute</i>              | <p>It means to Change default route to this VPN tunnel ( Only single WAN supports this).</p> <p>droute=on/off means to enable/disable the function.</p>                                                                                           |

## Example

```
> vpn option 1 idle=250
% Change Log..

% Idle Timeout = 250
```

## Telnet Command: vpn mroute

This command allows users to list, add or delete static routes for a certain LAN to LAN VPN profile.

### Syntax

```
vpn mroute <index> list
vpn mroute <index> add <network ip>/<mask>
vpn mroute <index> del <network ip>/<mask>
```

### Syntax Description

| Parameter   | Description                                    |
|-------------|------------------------------------------------|
| <i>list</i> | It means to display all of the route settings. |

|                                        |                                                                                 |
|----------------------------------------|---------------------------------------------------------------------------------|
| <i>add</i>                             | It means to add a new route.                                                    |
| <i>del</i>                             | It means to delete specified route.                                             |
| <i>&lt;index&gt;</i>                   | It means the index number of the profile.<br>Available index numbers:<br>1 - 32 |
| <i>&lt;network ip&gt;/&lt;mask&gt;</i> | Enter the IP address with the network mask address.                             |

### Example

```
> vpn mroute 1 add 192.168.5.0/24
% 192.168.5.0/24
% Add new route 192.168.5.0/24 to profile 1
```

### Telnet Command: vpn list

This command allows users to view LAN to LAN VPN profiles.

### Syntax

```
vpn list <index> all
vpn list <index> com
vpn list <index> out
vpn list <index> in
vpn list <index> net
```

### Syntax Description

| Parameter            | Description                                                                     |
|----------------------|---------------------------------------------------------------------------------|
| <i>all</i>           | It means to list configuration of the specified profile.                        |
| <i>com</i>           | It means to list common settings of the specified profile.                      |
| <i>out</i>           | It means to list dial-out settings of the specified profile.                    |
| <i>in</i>            | It means to list dial-in settings of the specified profile.                     |
| <i>net</i>           | It means to list Network Settings of the specified profile.                     |
| <i>&lt;index&gt;</i> | It means the index number of the profile.<br>Available index numbers:<br>1 - 32 |

### Example

```
> vpn list 32 all
% Common Settings

% Profile Name           : ???
% Profile Status        : Disable
% Netbios Naming Packet : Pass
% Call Direction        : Both
% Idle Timeout          : 300
% PING to keep alive    : off

% Dial-out Settings

% Type of Server         : PPTP
% Link Type:             : 64k bps
% Username               : ???
```

```

% Password :
% PPP Authentication : PAP/CHAP
% VJ Compression : on
% Pre-Shared Key :
% IPSec Security Method : AH
% Schedule : 0,0,0,0
% Remote Callback : off
% Provide ISDN Number : off
% IKE phase 1 mode : Main mode
% IKE Local ID :

% Dial-In Settings

--- MORE --- ['q': Quit, 'Enter': New Lines, 'Space Bar': Next Page] ---
> vpn list 1 com
% Common Settings

% Profile Name : ???
% Profile Status : Disable
% Netbios Naming Packet : Pass
% Call Direction : Both
% Idle Timeout : 300
% PING to keep alive : off
>

```

## Telnet Command: vpn remote

This command allows users to enable or disable *PPTP/IPSec/L2TP* VPN service.

### Syntax

vpn remote <*PPTP/IPsec/L2TP/SSLVPN*> <*on/off*>

### Syntax Description

| Parameter                     | Description                                                          |
|-------------------------------|----------------------------------------------------------------------|
| <i>PPTP/IPSec/L2TP/SSLVPN</i> | There are four types to be selected.                                 |
| <i>on/off</i>                 | on - enable VPN remote setting.<br>off - disable VPN remote setting. |

### Example

```

> vpn remote PPTP on
Set PPTP VPN Service : On

Please restart the router!!

```

## Telnet Command: vpn trunk

This command allows users to configure VPN Backup, VPN load balance, GRE over IPsec, and Binding tunnel policy.

```

vpn trunk show_usable
vpn trunk backup <add/del> <name> <Member#1> <Member#2>
vpn trunk backup more_syslog <ON/OFF>
vpn trunk backup ERD <name> <Normal/Recover/Resume><second>
vpn trunk lb <add/del> <name> <Member#1> <Member#2>
vpn trunk lb more_syslog <ON/OFF>
vpn trunk lb algorithm <name> <RR>
vpn trunk lb algorithm <name><W-RR><Auto> <AccordingRatio> <Member1:Member2>
vpn trunk lb algorithm <name><Fastest>
vpn trunk bind usage <BindIndex>
vpn trunk bind show <LoadBalanceName>
vpn trunk bind reset_default
vpn trunk bind more_syslog <ON/OFF>
vpn trunk bind set <BindIndex> <ACT> <TrunkName> <Member> <SrcIp:A-B> <DstIp:A-B>
<DstPort:A-B> <Proto> <Frag>
vpn trunk bind insert <After_BindIndex> <ACT> <TrunkName> <Member> <SrcIp:A-B>
<DstIp:A-B> <DstPort:A-B> <Proto> <Frag>
vpn trunk SetGre show <Dialout_Index>
vpn trunk SetGre
<Active/In-active><Dialout_Index><GRE_MyIP><GRE_PeerIP><Logical_Traffic>
vpn trunk An_Gre GreIPsecAnalyze <ON/OFF>

```

### Syntax Description

| Parameter                                                                                                          | Description                                                                                                                                                                                                                                                                                                                                                                                                                                                                                                                                                |
|--------------------------------------------------------------------------------------------------------------------|------------------------------------------------------------------------------------------------------------------------------------------------------------------------------------------------------------------------------------------------------------------------------------------------------------------------------------------------------------------------------------------------------------------------------------------------------------------------------------------------------------------------------------------------------------|
| <i>show_usable</i>                                                                                                 | Display a list of LAN to LAN dial out profiles.                                                                                                                                                                                                                                                                                                                                                                                                                                                                                                            |
| <i>backup &lt;add/del&gt; &lt;name&gt;<br/>&lt;Member#1&gt; &lt;Member#2&gt;</i>                                   | Set multiple VPN tunnels (LAN to LAN profiles) as backup tunnel.<br>add/del - Add or delete a profile for used in VPN Trunk.<br>name - Specify the name of the VPN trunk.<br>Member#1 - Indicate the first LAN to LAN profile.<br>Member#2 - Indicate the second LAN to LAN profile.                                                                                                                                                                                                                                                                       |
| <i>backup more_syslog<br/>&lt;ON/OFF&gt;<br/>lb more_syslog &lt;ON/OFF&gt;<br/>bind more_syslog &lt;ON/OFF&gt;</i> | These commands are used for RD debug.                                                                                                                                                                                                                                                                                                                                                                                                                                                                                                                      |
| <i>backup ERD &lt;name&gt;<br/>&lt;Normal/Recover/Resume&gt;<br/>&lt;second&gt;</i>                                | ERD means Environment Recovers Detection.<br>name - Specify the name of the VPN trunk.<br>Normal - Indicate the Normal mode. All dial-out VPN TRUNK backup profiles will be activated alternatively.<br>Recover - Indicate the duration of VPN backup operation.<br>Resume - When VPN connection breaks down or disconnects, Member 1 will be the top priority for the system to do VPN connection.<br>Second - "0" means to dial each six seconds automatically. "60 - 2147483647" means to early handle for less than 30 seconds within designated time. |
| <i>lb &lt;add/del&gt; &lt;name&gt;<br/>&lt;Member#1&gt; &lt;Member#2&gt;</i>                                       | It means to create VPN trunk with load balance.<br>add/del - Add or delete a profile for used in VPN Trunk.<br>name - Specify the name of the VPN trunk.                                                                                                                                                                                                                                                                                                                                                                                                   |



|                                                                                                                                                                                          |                                                                                                                                                                                                                                                                                                                                                                                                                                                                                                                                                                                                                                                                                                                                                                                                                                                                                                                                                                                                                                                             |
|------------------------------------------------------------------------------------------------------------------------------------------------------------------------------------------|-------------------------------------------------------------------------------------------------------------------------------------------------------------------------------------------------------------------------------------------------------------------------------------------------------------------------------------------------------------------------------------------------------------------------------------------------------------------------------------------------------------------------------------------------------------------------------------------------------------------------------------------------------------------------------------------------------------------------------------------------------------------------------------------------------------------------------------------------------------------------------------------------------------------------------------------------------------------------------------------------------------------------------------------------------------|
|                                                                                                                                                                                          | <p>Member#1 - Indicate the first LAN to LAN profile.<br/>Member#2 - Indicate the second LAN to LAN profile.</p>                                                                                                                                                                                                                                                                                                                                                                                                                                                                                                                                                                                                                                                                                                                                                                                                                                                                                                                                             |
| <p><i>lb algorithm</i> &lt;name&gt;<br/>&lt;RR/W-RR/Fastest&gt;</p>                                                                                                                      | <p>Set multiple VPN tunnels for using as traffic load balance tunnel. Such command is to configure the algorithm (with round robin mode) of Load Balance.<br/>name - Specify the name of the VPN trunk.<br/>RR - It means round robin mode. All of the dial-out profiles will be taken turns equally.</p>                                                                                                                                                                                                                                                                                                                                                                                                                                                                                                                                                                                                                                                                                                                                                   |
| <p><i>lb algorithm</i><br/>&lt;name&gt;&lt;W-RR&gt;&lt;Auto&gt;<br/>&lt;AccordingRatio&gt;<br/>&lt;Member1:Member2&gt;</p>                                                               | <p>Such command is to configure the algorithm (with round robin mode) of Load Balance.<br/>name - Specify the name of the VPN trunk.<br/>W-RR - It means weighted round robin mod based on speed ratio.</p> <ul style="list-style-type: none"> <li>● <i>Auto</i> - the speed must be based on Lay2.</li> <li>● <i>AccordingRatio</i> - the speed must be based on given ratio.</li> </ul> <p>Member#1 - Indicate the first LAN to LAN profile.<br/>Member#2 - Indicate the second LAN to LAN profile.</p>                                                                                                                                                                                                                                                                                                                                                                                                                                                                                                                                                   |
| <p><i>lb algorithm</i><br/>&lt;name&gt;&lt;Fastest&gt;</p>                                                                                                                               | <p>Such command is to configure the algorithm (with fastest mode) of Load Balance. Most of traffics will be led to the channel with the fastest connection.<br/>name - Specify the name of the VPN trunk.</p>                                                                                                                                                                                                                                                                                                                                                                                                                                                                                                                                                                                                                                                                                                                                                                                                                                               |
| <p><i>bind usage</i> &lt;BindIndex&gt;</p>                                                                                                                                               | <p>Display detailed information for VPN Load Balance Tunnel Bind.<br/>BindIndex - Indicate the index number of the tunnel bind.</p>                                                                                                                                                                                                                                                                                                                                                                                                                                                                                                                                                                                                                                                                                                                                                                                                                                                                                                                         |
| <p><i>bind show</i><br/>&lt;LoadBalanceName&gt;</p>                                                                                                                                      | <p>Display the bind information for VPN Load Balance profile.<br/>LoadBalanceName - type the name of VPN Load Balance profile</p>                                                                                                                                                                                                                                                                                                                                                                                                                                                                                                                                                                                                                                                                                                                                                                                                                                                                                                                           |
| <p><i>bind reset_default</i></p>                                                                                                                                                         | <p>Reset the bind tunnel for VPN load balance to factory reset settings.</p>                                                                                                                                                                                                                                                                                                                                                                                                                                                                                                                                                                                                                                                                                                                                                                                                                                                                                                                                                                                |
| <p><i>bind set</i> &lt;BindIndex&gt; &lt;ACT&gt;<br/>&lt;TrunkName&gt; &lt;Member&gt;<br/>&lt;SrcIp:A-B&gt; &lt;DstIp:A-B&gt;<br/>&lt;DstPort:A-B&gt; &lt;Proto&gt;<br/>&lt;Frag&gt;</p> | <p>Set the binding tunnel policy.<br/>BindIndex - Indicate the index number (1 - 64) for the tunnel to be bound.</p> <pre>vpn trunk bind set 1 y vpnlb 1 192.168.10.1~192.168.10.2 192.168.99.1~192.168.99.254 1~65535 0 OFF</pre> <p>ACT - Specify the action. "y" means active; "n" means inactive or delete.<br/>TrunkName - TrunkName - Specify the name of the VPN trunk created by using "vpn trunk lb" command.<br/>Member - Specify the index number of the LAN to LAN (dial-out) profile to be bound.<br/>SrcIp:A-B - Specify the source IP range (e.g., 192.168.10.0-192.168.10.255.<br/>DstIp:A-B - Specify the destination IP range (e.g., 192.168.1.0-192.168.1.255.<br/>DstPort:A-B - Specify the destination port range (1-65535).<br/>Proto - Specify the protocol.</p> <ul style="list-style-type: none"> <li>0 - any</li> <li>1 - ICMP</li> <li>2 - IGMP</li> <li>6 - TCP</li> <li>17 - UDP</li> <li>255 - TCP/UDP</li> </ul> <p>Frag - "ON" means to bind the fragmented packet; "OFF" means not to care. It is the default setting.</p> |
| <p><i>bind insert</i><br/>&lt;After_BindIndex&gt; &lt;ACT&gt;<br/>&lt;TrunkName&gt; &lt;Member&gt;</p>                                                                                   | <p>It is used to insert additional load balance policy into an existing policy.<br/>After_BindIndex - Specify an index number that new additional</p>                                                                                                                                                                                                                                                                                                                                                                                                                                                                                                                                                                                                                                                                                                                                                                                                                                                                                                       |

|                                                                                                                          |                                                                                                                                                                                                                                                                                                                                                                                                                                                                                                                                                                                                                                                                                                                                                                                                                                                                                                                                                                                   |
|--------------------------------------------------------------------------------------------------------------------------|-----------------------------------------------------------------------------------------------------------------------------------------------------------------------------------------------------------------------------------------------------------------------------------------------------------------------------------------------------------------------------------------------------------------------------------------------------------------------------------------------------------------------------------------------------------------------------------------------------------------------------------------------------------------------------------------------------------------------------------------------------------------------------------------------------------------------------------------------------------------------------------------------------------------------------------------------------------------------------------|
| <pre>&lt;SrcIp:A-B&gt; &lt;DstIp:A-B&gt; &lt;DstPort:A-B&gt; &lt;Proto&gt; &lt;Frag&gt;</pre>                            | <p>policy should be inserted before. See the following example:</p> <pre>vpn trunk bind insert 1 y vpnlb 2 192.168.10.3~192.168.10.200 192.168.99.200~192.168.99.200 80~80 TCP OFF</pre> <p>ACT - Specify the action. "y" means active; "n" means inactive or delete.</p> <p>TrunkName - Specify the name of the VPN trunk.</p> <p>Member - Specify the index number of the LAN to LAN (dial-out) profile to be bound.</p> <p>SrcIp:A-B - Specify the source IP range (e.g., 192.168.10.0-192.168.10.255).</p> <p>DstIp:A-B - Specify the destination IP range (e.g., 192.168.1.0-192.168.1.255).</p> <p>DstPort:A-B - Specify the destination port range (1-65535).</p> <p>Proto - Specify the protocol.</p> <ul style="list-style-type: none"> <li>0 - any</li> <li>1 - ICMP</li> <li>2 - IGMP</li> <li>6 - TCP</li> <li>17 - UDP</li> <li>255 - TCP/UDP</li> </ul> <p>Frag - "ON" means to bind the fragmented packet; "OFF" means not to care. It is the default setting.</p> |
| <pre>SetGre show &lt;Dialout_Index&gt;</pre>                                                                             | <p>Display the GRE over IPSec settings in specified LAN to LAN profile.</p> <p>Dialout_Index - Index number of the LAN to LAN (dial-out) profile.</p>                                                                                                                                                                                                                                                                                                                                                                                                                                                                                                                                                                                                                                                                                                                                                                                                                             |
| <pre>SetGre &lt;Active/In-active&gt;&lt;Dialout_Index&gt;&lt;GRE_MyIP&gt;&lt;GRE_PeerIP&gt;&lt;Logical_Traffic&gt;</pre> | <p>Active/In-active - Specify the action. "y" means active; "n" means inactive.</p> <p>Dialout_Index - Index number of the LAN to LAN (dial-out) profile.</p> <p>GRE_MyIP -Enter the virtual IP for router itself for verified by peer.</p> <p>GRE_PeerIP -Enter the virtual IP of peer host for verified by router.</p> <p>Logical_Traffic - Specify the action for RFC2890. "y" means active; "n" means inactive.</p>                                                                                                                                                                                                                                                                                                                                                                                                                                                                                                                                                           |
| <pre>An_Gre GreIPsecAnalyze &lt;ON/OFF&gt;</pre>                                                                         | <p>These commands are used for RD debug.</p>                                                                                                                                                                                                                                                                                                                                                                                                                                                                                                                                                                                                                                                                                                                                                                                                                                                                                                                                      |

## Example

```
> vpn setup 1 name1 pptp_out 1.2.3.4 vigor 1234 192.168.1.0 255.255.255.0
% Profile Change Log ...

% Profile Index : 1
% Profile Name : name1j
% Username : vigor
% Password : 1234
% Call Direction : Dial-Out
% Type of Server : PPTP
% Dial to : 1.2.3.4
% Remote Network IP : 192.168.1.0
% Remote Network Mask : 255.255.255.0
> vpn setup 2 market pptp_out 5.6.7.8 vigor 5678 192.168.1.31 255.255.255.0
% Profile Change Log ...

% Profile Index : 2
% Profile Name : market
% Username : vigor
% Password : 5678
```

```

% Call Direction : Dial-Out
% Type of Server : PPTP
% Dial to : 5.6.7.8
% Remote Network IP : 192.168.1.31
% Remote Network Mask : 255.255.255.0
> vpn trunk lb add comp 1 2
%% Combination VPN Load Balance profile list :
  <Index>  <  Name  >  <  Member1(Active)Type  >  <
Member2(Act
ive)Type  >
      1      comp      1(YES)PPTP      2(YES)PPTP

%% Note: <Active: NO> The LAN-to-LAN Profile is disable or under Dial-In(Call
Direction) at present.
=====

% Setting OK.
> vpn trunk bind set 1 y comp 2 192.168.10.1~192.168.10.2
192.168.99.1~192.168.99.254 1~65535 0 OFF
% VPN Load Balance Tunnel Bind Table Index[1] detail:
=====
Action          = ACTIVE
Trunk Profile(000) Name= comp
Binding Dial Out Index = 2
Binding Src IP   = 192.168.10.1 ~ 192.168.10.2
Binding Dest IP  = 192.168.99.1 ~ 192.168.99.254
Binding Dest Port = 1 ~ 65535
Binding Fragmented = NO
Binding Protocol = ANY Protocol
>

```

## Telnet Command: vpn NetBios

This command allows users to enable or disable NetBios for Remote Access User Accounts or LAN-to-LAN Profile.

### Syntax

vpn NetBios set <H2I/L2I> <index> <Block/Pass>

### Syntax Description

| Parameter    | Description                                                                                                                                                                                                                                                                                             |
|--------------|---------------------------------------------------------------------------------------------------------------------------------------------------------------------------------------------------------------------------------------------------------------------------------------------------------|
| <H2I/L2I>    | H2I means Remote Access User Accounts.<br>L2I means LAN-to-LAN Profile.<br>Specify which one will be applied by NetBios.                                                                                                                                                                                |
| <index>      | The index number (1 to 48) of the profile.                                                                                                                                                                                                                                                              |
| <Block/Pass> | Pass - Have an inquiry for data transmission between the hosts located on both sides of VPN Tunnel while connecting.<br>Block - When there is conflict occurred between the hosts on both sides of VPN Tunnel in connecting, set it block data transmission of Netbios Naming Packet inside the tunnel. |

### Example

```

> vpn NetBios set H2I 1 Pass

```

```
% Remote Dial In Profile Index [1] :
% NetBios Block/Pass: [PASS]
```

## Telnet Command: vpn mss

This command allows users to configure the maximum segment size (MSS) for different TCP types.

### Syntax

```
vpn mss show
```

```
vpn mss default
```

```
vpn mss set <connection type> <TCP maximum segment size range>
```

### Syntax Description

| Parameter                                     | Description                                                                                                                                                                               |
|-----------------------------------------------|-------------------------------------------------------------------------------------------------------------------------------------------------------------------------------------------|
| <i>show</i>                                   | It means to display current setting status.                                                                                                                                               |
| <i>default</i>                                | TCP maximum segment size for all the VPN connection will be set as 1360 bytes.                                                                                                            |
| <i>set</i>                                    | Use it to specify the connection type and value of MSS.                                                                                                                                   |
| <i>&lt;connection type&gt;</i>                | 1-4 represent various type.<br>1 - PPTP<br>2 - L2TP<br>3 - IPSec<br>4 - L2TP over IPSec<br>5 - vpn 2ndsubnet on<br>6 - SSL Tunnel                                                         |
| <i>&lt;TCP maximum segment size range&gt;</i> | Each type has different segment size range.<br>PPTP - 1 ~ 1412<br>L2TP - 1 ~ 1408<br>IPSec - 1 ~ 1381<br>L2TP over IPSec - 1 ~ 1361<br>GRE over IPsec - 1 ~ 1365<br>SSL Tunnel - 1 ~ 1360 |

### Example

```
>vpn mss set 1 1400
% VPN TCP maximum segment size (MSS) :
  PPTP = 1400
  L2TP = 1360
  IPSec = 1360
  L2TP over IPSec = 1360
  GRE over IPsec = 1360
  SSL Tunnel = 1260
>vpn mss show
VPN TCP maximum segment size (MSS) :
PPTP = 1400
L2TP = 1360
IPSec = 1360
L2TP over IPSec = 1360
GRE over IPsec = 1360
SSL Tunnel = 1260
```

## Telnet Command: vpn ike

This command is used to display IKE memory status and leakage list.

### Syntax

vpn ike -q

vpn ike -s

### Example

```
> vpn ike -q
IKE Memory Status and Leakage List

# of free L-Buffer=95, minimum=94, leak=1
# of free M-Buffer=529, minimum=529 leak=3
# of free S-Buffer=1199, minimum=1198, leak=1
# of free Msgid-Buffer=1024, minimum=1024
```

## Telnet Command: vpn Multicast

This command allows users to pass or block the multi-cast packet via VPN.

### Syntax

vpn Multicast set <H2L/L2L> <index> <Block/Pass>

### Syntax Description

| Parameter    | Description                                                                           |
|--------------|---------------------------------------------------------------------------------------|
| <H2L/L2L>    | H2L means Host to LAN (Remote Access User Accounts).<br>L2L means LAN-to-LAN Profile. |
| <index>      | The index number (1 to 64) of the profile.                                            |
| <Block/Pass> | Set Block/Pass the Multicast Packets.<br>The default is Block.                        |

### Example

```
> vpn Multicast set L2L 1 Pass
% Lan to Lan Profile Index [1] :
% Status Block/Pass: [PASS]
```

## Telnet Command: vpn pass2nd

This command allows users to determine if the packets coming from the second subnet passing through current used VPN tunnel.

### Syntax

vpn pass2nd <on/off>

### Syntax Description

| Parameter | Description                                                                          |
|-----------|--------------------------------------------------------------------------------------|
| on/off    | on - the packets can pass through NAT.<br>off - the packets cannot pass through NAT. |

### Example

```
> vpn pass2nd on
% 2nd subnet is allowed to pass VPN tunnel!
```

## Telnet Command: vpn pass2nat

This command allows users to determine if the packets passing through by NAT or not when the VPN tunnel disconnects.

### Syntax

```
vpn pass2nat <on/off>
```

### Syntax Description

| Parameter     | Description                                                                          |
|---------------|--------------------------------------------------------------------------------------|
| <i>on/off</i> | on - the packets can pass through NAT.<br>off - the packets cannot pass through NAT. |

### Example

```
> vpn pass2nat on
% Packets would go through by NAT when VPN disconnect!!
```

## Telnet Command: vpn sameSubnet

This command allows users to build VPN between clients via virtual subnet.

### Syntax

```
vpn sameSubnet -i <value>
vpn sameSubnet -E <0/1>
vpn sameSubnet -e <value>
vpn sameSubnet -l <Virtual Subnet>
vpn sameSubnet -o <add/del>
vpn sameSubnet -v
vpn sameSubnet -m
```

### Syntax Description

| Parameter                        | Description                                                                        |
|----------------------------------|------------------------------------------------------------------------------------|
| <i>-i &lt;value&gt;</i>          | Specify the index number of VPN profile.                                           |
| <i>-E &lt;0/1&gt;</i>            | Enable or disable the IPsec with the same subnet.<br>1 - enable.<br>0 - disable.   |
| <i>-e &lt;value&gt;</i>          | Translate specified LAN to virtual subnet.<br>1 - LAN1<br>2 - LAN2<br>3 - LAN3 ... |
| <i>-l &lt;Virtual Subnet&gt;</i> | Set the virtual subnet (e.g., 172.16.3.250).                                       |
| <i>-v</i>                        | Display current status of virtual subnet.                                          |
| <i>-m &lt;1/2&gt;</i>            | Set the Translated Type.<br><1/2> - 1 for Whole Subnet, 2 for Specific IP.         |

## Example

```
> vpn sameSubnet -i 1 -e 1 -E 1 -e 1 -I 10.10.10.0 -o add
Enable IPsec with Same Subnet !!

Add entry Success!!
> vpn sameSubnet -v
IPsec with the same subnet:
VPN profile 1 enable,
Whole Subnet:
  translated LAN1 to Virtual subnet: 10.10.10.0
  translated LAN1 to Virtual subnet: 10.10.10.0
  translated LAN1 to Virtual subnet: 10.10.10.0
>
```

## Telnet Command: vpn ovpn

This command allows users to build VPN between clients via OpenVPN.

### Syntax

```
vpn ovpn mode <0/1>
vpn ovpn show
vpn ovpn udp_mode <0/1>
vpn ovpn tcp_mode <0/1>
vpn ovpn udp_port <1-65535>
vpn ovpn tcp_port <1-65535>
vpn ovpn cert <0/1>
vpn ovpn replay <0/1>
vpn ovpn certmode <0/1/2>
vpn ovpn hmacmode <0/1/2>
vpn ovpn ca <0/1/2/3>
vpn ovpn tlsauth_del <1/2/3>
```

### Syntax Description

| Parameter                 | Description                                                            |
|---------------------------|------------------------------------------------------------------------|
| <i>mode</i> <0/1>         | Enable or disable the OpenVPN function.<br>1 - enable.<br>0 - disable. |
| <i>show</i>               | Displays current OpenVPN settings.                                     |
| <i>udp_mode</i> <0/1>     | Enable or disable the UDP mode.<br>1 - enable.<br>0 - disable.         |
| <i>tcp_mode</i> <0/1>     | Enable or disable the TCP mode.<br>1 - enable.<br>0 - disable.         |
| <i>udp_port</i> <1-65535> | Enter a port number (1-65535) for UDP mode.                            |
| <i>tcp_port</i> <1-65535> | Enter a port number (1-65535) for TCP mode.                            |
| <i>replay</i> <0/1>       | Enable or disable the replay option.<br>1 - enable.<br>0 - disable.    |

|                            |                                                                 |
|----------------------------|-----------------------------------------------------------------|
| <i>certmode</i> <0/1/2>    | Set the Cipher Algorithm Mode.<br>0: AES128, 1: AES256, 2: None |
| <i>hmacmode</i> <0/1/2>    | Set the Cipher HMAC Mode.<br>0: SHA1, 1: SHA256, 2: None        |
| <i>ca</i> <0/1/2/3>        | Set the Trust CA certificate.                                   |
| <i>tlsauth_del</i> <1/2/3> | Delete the first, second or the third TLS-auth key.             |

### Example

```
> vpn ovpn mode 1
Enable openvpn
> vpn ovpn show

Openvpn: Enable
support UDP: Enable
UDP port: 1194
support TCP: Enable
TCP port: 1194
Use certificate authentication: Enable
replay option: Enable
Cipher Algorithm: AES256
HMAC Algorithm: SHA256
Certificate uid: 65535
Trust CA uid: 0
```

## Telnet Command: wan ppp\_mru

This command allows users to adjust the size of PPP LCP MRU. It is used for specific network.

### Syntax

*wan ppp\_mru* <WAN interface number> <MRU size>

### Syntax Description

| Parameter              | Description                                                                                          |
|------------------------|------------------------------------------------------------------------------------------------------|
| <WAN interface number> | Type a number to represent the physical interface. For Vigor130, the number is 1 (which means WAN1). |
| <MRU size >            | It means the number of PPP LCP MRU. The available range is from 1400 to 1600.                        |

### Example

```
> wan ppp_mru 1 ?
% Now: 1492

> wan ppp_mru 1 1490
>
> wan ppp_mru 1 ?
% Now: 1490

> wan ppp_mru 1 1492
> wan ppp_mru 1 ?
% Now: 1492
```



## Telnet Command: wan mtu / wan mtu2

This command allows users to adjust the size of MTU for WAN1/WAN2.

### Syntax

wan mtu <value>

wan mtu2 <value>

### Syntax Description

| Parameter    | Description                                                                                                                                                                                                                             |
|--------------|-----------------------------------------------------------------------------------------------------------------------------------------------------------------------------------------------------------------------------------------|
| <i>value</i> | It means the number of MTU for PPP. The available range is from 1000 to 1500.<br>For Static IP/DHCP, the maximum number will be 1500.<br>For PPPoE, the maximum number will be 1492.<br>For PPTP/L2TP, the maximum number will be 1460. |

### Example

```
> wan mtu 1100
> wan mtu ?
Static IP/DHCP (Max MSS: 1500)
PPPoE(Max MSS: 1492)
PPTP/L2TP(Max MSS: 1460)
% wan ppp_mss <MSS size: 1000 ~ 1500>
% Now: 1100
```

## Telnet Command: wan dns

This command allows users to configure primary and / or secondary DNS server.

### Syntax

wan dns <wan\_no> <dns\_select> <ipv4\_addr>

### Syntax Description

| Parameter    | Description                                                                                                                  |
|--------------|------------------------------------------------------------------------------------------------------------------------------|
| <wan_no>     | Select WAN interface.<br>1 -4 - WAN1 ~ WAN4.                                                                                 |
| <dns_select> | Specify primary and / or secondary DNS server.<br>pri - It means primary DNS server.<br>sec - It means secondary DNS server. |
| <ipv4_addr>  | Enter the IP address of DNS server.                                                                                          |

### Example

```
> wan dns 1 pri 168.95.1.1
% Set WAN1 primary DNS done.
% Now: 168.95.1.1
```

## Telnet Command: wan DF\_check

This command allows you to enable or disable the function of DF (Don't fragment)

## Syntax

wan DF\_check <on/off>

## Syntax Description

| Parameter | Description                       |
|-----------|-----------------------------------|
| on/off    | It means to enable or disable DF. |

## Example

```
> wan DF_check on
%DF bit check enable!
> wan DF_check off
%DF bit check disable (reset DF bit)!
```

## Telnet Command: wan disable

This command allows you to disable WAN connection.

## Example

```
> wan disable WAN
%WAN disabled.
```

## Telnet Command: wan enable

This command allows you to enable wan connection.

## Example

```
> wan enable WAN
%WAN1 enabled.
```

## Telnet Command: wan wan2lan

When WAN2 is disabled or WAN2 is set as wireless physical mode, the ethernet port is configured as LAN port.

## Syntax

wan wan2lan <wan> <on / off / status>

## Syntax Description

| Parameter           | Description                                                                                                |
|---------------------|------------------------------------------------------------------------------------------------------------|
| <wan>               | Select a WAN interface (1 to 4). Currently, only WAN2 is available.                                        |
| <on / off / status> | On - Enable WAN to LAN port mode.<br>Off - Disable WAN to LAN port mode.<br>Status - Display current mode. |

## Example

```
> wan wan2lan 2 status
% Current WAN2 is WAN mode
```

```

% Usage: show the WAN to LAN setting, currently only support WAN2
% When WAN2 is disabled or WAN2 is set wireless physical mode, eth port
is configured as LAN
% Current WAN2 eth port is WAN mode
> wan wan2lan 2 on
% WAN2 convert to LAN6, WAN2 interface will disable
% Usage: show the WAN to LAN setting, currently only support WAN2
% When WAN2 is disabled or WAN2 is set wireless physical mode, eth port
is configured as LAN
% Current WAN2 eth port is LAN mode

```

## Telnet Command: wan forward

This command allows you to enable or disable the function of WAN forwarding. The packets are allowed to be transmitted between different WANs.

### Syntax

wan forward <on/off>

### Syntax Description

| Parameter | Description                                |
|-----------|--------------------------------------------|
| on/off    | It means to enable or disable WAN forward. |

### Example

```

> wan forward ?
%WAN forwarding is Disable!

> wan forward on
%WAN forwarding is enable!

```

## Telnet Command: wan status

This command allows you to display the status of WAN connection, including connection mode, TX/RX packets, DNS settings and IP address.

### Example

```

> wan status
WAN1: Offline, stall=N
Mode: ---, Up Time=00:00:00
IP=---, GW IP=---
TX Packets=0, TX Rate(Bps)=0, RX Packets=0, RX Rate(Bps)=0
Primary DNS=0.0.0.0, Secondary DNS=0.0.0.0

PVC_WAN3: Offline, stall=N
Mode: ---, Up Time=00:00:00
IP=---, GW IP=---
TX Packets=0, TX Rate(Bps)=0, RX Packets=0, RX Rate(Bps)=0

PVC_WAN4: Offline, stall=N
Mode: ---, Up Time=00:00:00
IP=---, GW IP=---

```

```

TX Packets=0, TX Rate(Bps)=0, RX Packets=0, RX Rate(Bps)=0

PVC_WAN5: Offline, stall=N
Mode: ---, Up Time=00:00:00
IP=---, GW IP=---
TX Packets=0, TX Rate(Bps)=0, RX Packets=0, RX Rate(Bps)=0

```

## Telnet Command: wan modem / wan modem2

This command, wan modem, allows you to configure 3G/4G USB Modem (PPP mode) of WAN3. The command, wan modem2, allows you to configure 3G/4G USB Modem (PPP mode) of WAN4.

### Syntax

```

wan modem <init/init2/dial/pin><string>
wan modem paponly <on/off>
wan modem backup_wait <value>
wan modem pipe <Int><Din><Dout> (for USB WAN3 only)
wan modem wakeup <on/off/value> (for USB WAN3 only)
wan modem vid <id>
wan modem pid <id>
wan modem status

```

### Syntax Description

| Parameter                    | Description                                                                                                                                                                                                               |
|------------------------------|---------------------------------------------------------------------------------------------------------------------------------------------------------------------------------------------------------------------------|
| <i>init</i>                  | Set initial modem AT command (default value is "AT&F&E0V1X1&D2&C1S0=0").                                                                                                                                                  |
| <i>init2</i>                 | Set the second initial modem AT command.                                                                                                                                                                                  |
| <i>dial</i> <string>         | Set dial modem AT command (default value is "ATDT*99#").                                                                                                                                                                  |
| <i>pin</i> <0>               | Set PIN code for SIM card.<br>"0": disable                                                                                                                                                                                |
| <i>paponly</i> <on/off>      | It means PAP Only. Set the PPP authentication of the USB WAN.<br>on: None.<br>off: PAP or CHAP.                                                                                                                           |
| <i>backup_wait</i> <value>   | Set waiting time after boot if USB WAN is in backup mode. This waiting time is reserved for the dial of main WANs so that the backup USB WAN will not go up first.<br>Available setting is from 1 to 255. Unit is second. |
| <i>pipe</i>                  | It is for RD debug only. Please don't use it without our advice.                                                                                                                                                          |
| <i>wakeup</i> <on/off/value> | It is for RD debug only. Please don't use it without our advice.                                                                                                                                                          |
| <i>vid</i>                   | Set VID of VID/PID match to bind the USB modem to specify WAN interface. By default, this match is not set (0x0/0x0) and the router specifies WAN interface by USB port.                                                  |
| <i>pid</i>                   | Set PID of VID/PID match to bind the USB modem to specify WAN interface. By default, this match is not set (0x0/0x0) and the router specifies WAN interface by USB port.                                                  |
| <i>status</i>                | Display current status of USB modem.                                                                                                                                                                                      |

### Example

```

> wan modem pin 0000
> wan modem status
Modem Link Speed=0
Current Signal Strength=0
Last Fail Message:
Current Connect Stage:

```

## Telnet Command: wan lte

This command allows you to configure LTE WAN (for L model only).

### Syntax

```

wan lte auth <0/1>
wan lte band
wan lte del <index #/all>
wan lte pass <string>
wan lte pre_band
wan lte quota [-<command><parameter>I...]
wan lte read <index #/all>
wan lte reboot [-<command><parameter>I...]
wan lte reply [-<command><parameter>I...]
wan lte send <number><message>
wan lte sms [-<command><parameter>I...]
wan lte scan [-<command><parameter>I...]
wan lte set [-<command><parameter>I...]
wan lte stus
wan lte tag <index #/all>
wan lte user <string>
wan lte wms <send<cdma/gwpp>/recv<cdma/gwgw>/setting>

```

### Syntax Description

| Parameter                                        | Description                                                                                                                                                                                                                                                                                                                                                                                                                         |
|--------------------------------------------------|-------------------------------------------------------------------------------------------------------------------------------------------------------------------------------------------------------------------------------------------------------------------------------------------------------------------------------------------------------------------------------------------------------------------------------------|
| <i>auth</i> <0/1>                                | Set PPP authentication of LTE WAN.<br>0: None.<br>1: PAP or CHAP.                                                                                                                                                                                                                                                                                                                                                                   |
| <i>band</i>                                      | Display working band information for LTE network connection.                                                                                                                                                                                                                                                                                                                                                                        |
| <i>del</i> <index #/all>                         | Delete an SMS from the LTE SIM card by specifying the index number. Use “all” to delete all.                                                                                                                                                                                                                                                                                                                                        |
| <i>pass</i> <string>                             | Set the password of LTE WAN.                                                                                                                                                                                                                                                                                                                                                                                                        |
| <i>quota</i><br>[-<command><parameter>I...]<br>] | Set settings of SMS Quota Limit function.<br>Available commands with parameter are listed below:<br>[...] means that you can Enter several commands in one line.<br>-a <0/1>: Set whether to send an e-mail alert when SMS quota exceeded. (0: no 1: yes)<br>-c <cycle>: Set the order of today in refresh cycle.<br>-d <day>: Set the refresh day.<br>-e <0/1>: Enable or disable SMS Quota Limit function. (0: disable 1: enable) |

|                                           |                                                                                                                                                                                                                                                                                                                                                                                                                                                                                                                                                                                                                                                                                                                                                                                                                                                                                                                                                                                                                                                                                                                                                                                                                                                                                                                                                                                                                                                                                                                                                                                                                                                                                                                                                                                                                     |
|-------------------------------------------|---------------------------------------------------------------------------------------------------------------------------------------------------------------------------------------------------------------------------------------------------------------------------------------------------------------------------------------------------------------------------------------------------------------------------------------------------------------------------------------------------------------------------------------------------------------------------------------------------------------------------------------------------------------------------------------------------------------------------------------------------------------------------------------------------------------------------------------------------------------------------------------------------------------------------------------------------------------------------------------------------------------------------------------------------------------------------------------------------------------------------------------------------------------------------------------------------------------------------------------------------------------------------------------------------------------------------------------------------------------------------------------------------------------------------------------------------------------------------------------------------------------------------------------------------------------------------------------------------------------------------------------------------------------------------------------------------------------------------------------------------------------------------------------------------------------------|
|                                           | <p>-h &lt;hour&gt;: Set the refresh hour.</p> <p>-m &lt;0/1/2&gt;: Set SMS quota refresh mode. (0: None 1: monthly 2: periodically)</p> <p>-n &lt;number&gt;: Set SMS quota. The available number is between 1 and 1000000.</p> <p>-s &lt;0/1&gt;: Set whether to stop sending SMS after SMS quota exceeded. (0: no 1: yes)</p>                                                                                                                                                                                                                                                                                                                                                                                                                                                                                                                                                                                                                                                                                                                                                                                                                                                                                                                                                                                                                                                                                                                                                                                                                                                                                                                                                                                                                                                                                     |
| <i>read &lt;index #/all&gt;</i>           | Display information of an SMS in the LTE SIM card by specifying the index number. Use "all" to display all.                                                                                                                                                                                                                                                                                                                                                                                                                                                                                                                                                                                                                                                                                                                                                                                                                                                                                                                                                                                                                                                                                                                                                                                                                                                                                                                                                                                                                                                                                                                                                                                                                                                                                                         |
| <i>reboot</i>                             | <p>Set settings of Reboot on SMS Message function.</p> <p>&lt;command&gt; &lt;parameter&gt;   ...</p> <p>The available commands with parameters are listed below.</p> <p>[...] means that you can Enter several commands in one line.</p> <p>-a &lt;0/1&gt;: Enable or disable Access Control List. (0: disable 1: enable)</p> <p>-e &lt;0/1&gt;: Enable or disable Reboot on SMS Message function. (0: disable 1: enable)</p> <p>-p &lt;password&gt;: Set the Password / PIN. This setting is necessary if this function is enabled.</p> <p>-x &lt;number&gt;: Set the first phone number in Access Control List.</p> <p>-y &lt;number&gt;: Set the second phone number in Access Control List.</p> <p>-z &lt;number&gt;: Set the third phone number in Access Control List.</p>                                                                                                                                                                                                                                                                                                                                                                                                                                                                                                                                                                                                                                                                                                                                                                                                                                                                                                                                                                                                                                   |
| <i>reply</i>                              | <p>Set settings of Reply with Router Status Message function.</p> <p>&lt;command&gt; &lt;parameter&gt;   ...</p> <p>The available commands with parameters are listed below.</p> <p>[...] means that you can Enter several commands in one line.</p> <p>-a &lt;0/1&gt;: Enable or disable Access Control List. (0: disable 1: enable)</p> <p>-c &lt;0/1&gt;: Set whether to reply with MAC address. (0: no 1: yes)</p> <p>-e &lt;0/1&gt;: Enable or disable Reboot on SMS Message function. (0: disable 1: enable)</p> <p>-f &lt;0/1&gt;: Set whether to reply with WAN1 IP address. (0: no 1: yes)</p> <p>-g &lt;0/1&gt;: Set whether to reply with WAN2 IP address. (0: no 1: yes)</p> <p>-h &lt;0/1&gt;: Set whether to reply with LTE WAN IP address. (0: no 1: yes)</p> <p>-i &lt;0/1&gt;: Set whether to reply with WAN4 IP address. (0: no 1: yes)</p> <p>-j &lt;0/1&gt;: Set whether to reply with WAN1 data usage. (0: no 1: yes)</p> <p>-k &lt;0/1&gt;: Set whether to reply with WAN2 data usage. (0: no 1: yes)</p> <p>-l &lt;0/1&gt;: Set whether to reply with LTE WAN data usage. (0: no 1: yes)</p> <p>-m &lt;0/1&gt;: Set whether to reply with WAN4 data usage. (0: no 1: yes)</p> <p>-n &lt;0/1&gt;: Set whether to reply with Router name. (0: no 1: yes)</p> <p>-p &lt;password&gt;: Set the Password / PIN. This setting is necessary if this function is enabled.</p> <p>-u &lt;0/1&gt;: Set whether to reply with Router system uptime. (0: no 1: yes)</p> <p>-v &lt;0/1&gt;: Set whether to reply with Router firmware version. (0: no 1: yes)</p> <p>-x &lt;number&gt;: Set the first phone number in Access Control List.</p> <p>-y &lt;number&gt;: Set the second phone number in Access Control List.</p> <p>-z &lt;number&gt;: Set the third phone number in Access Control List.</p> |
| <i>send &lt;number&gt;&lt;message&gt;</i> | Send an SMS message to the specified phone number through the LTE SIM card.                                                                                                                                                                                                                                                                                                                                                                                                                                                                                                                                                                                                                                                                                                                                                                                                                                                                                                                                                                                                                                                                                                                                                                                                                                                                                                                                                                                                                                                                                                                                                                                                                                                                                                                                         |
| <i>sms</i>                                | It means to set advanced settings for SMS.                                                                                                                                                                                                                                                                                                                                                                                                                                                                                                                                                                                                                                                                                                                                                                                                                                                                                                                                                                                                                                                                                                                                                                                                                                                                                                                                                                                                                                                                                                                                                                                                                                                                                                                                                                          |

|                                 |                                                                                                                                                                                                                                                                                                                                                                                                                                                                                                                                                                                                                                                                                                                                                                                                                                                                                                                                                                                                                                                                                                                                                                                                                                                                                                                                                                                                                                                                                                                                                                                                                                                   |
|---------------------------------|---------------------------------------------------------------------------------------------------------------------------------------------------------------------------------------------------------------------------------------------------------------------------------------------------------------------------------------------------------------------------------------------------------------------------------------------------------------------------------------------------------------------------------------------------------------------------------------------------------------------------------------------------------------------------------------------------------------------------------------------------------------------------------------------------------------------------------------------------------------------------------------------------------------------------------------------------------------------------------------------------------------------------------------------------------------------------------------------------------------------------------------------------------------------------------------------------------------------------------------------------------------------------------------------------------------------------------------------------------------------------------------------------------------------------------------------------------------------------------------------------------------------------------------------------------------------------------------------------------------------------------------------------|
|                                 | <p>-a &lt;0/1&gt; : Alerts admin with e-mail when SMS inbox is full.</p> <p>-d &lt;0/1&gt; : Delete oldest read SMS when SMS inbox is full.</p> <p>-f &lt;0/1&gt; : Forward new SMS by e-mail to admin.</p> <p>-s &lt;0/1&gt; : Store SMS outbox cache with USB disk.<br/>(0: disable 1: enable)</p>                                                                                                                                                                                                                                                                                                                                                                                                                                                                                                                                                                                                                                                                                                                                                                                                                                                                                                                                                                                                                                                                                                                                                                                                                                                                                                                                              |
| <i>scan</i> <all/4g/3g/2g/show> | <p>It means to scan visible networks.</p> <p>[all/4g/3g/2g]: Scan all, 4g, 3g or 2g network.</p> <p>Show: Display the scanning result.</p>                                                                                                                                                                                                                                                                                                                                                                                                                                                                                                                                                                                                                                                                                                                                                                                                                                                                                                                                                                                                                                                                                                                                                                                                                                                                                                                                                                                                                                                                                                        |
| <i>set</i>                      | <p>It means to set APN name, keep alive time and so on.</p> <p>apn &lt;apn_name&gt; : Set a string as APN.</p> <p>pin &lt;pin_code&gt;: Set a pin code.</p> <p>power_recycle &lt;backoff_time(0-20)&gt;: Set the power recycle time (seconds) for redialing after power off.</p> <p>dial_on: Turn of the dialing function. It is used for RD debug.</p> <p>dial_off: Turn off the dialing function. It is used for RD debug.</p> <p>keep_alive_on &lt;IP&gt;: Turn of the function of Keep Alive On. Specify the IP address (x.x.x.x).</p> <p>keep_alive_off: Turn off the function of Keep Alive On.</p> <p>dhcp&lt;on/off&gt;: Turn on or off the DHCP server, depending on your ISP configuration.</p> <p>fixed &lt;IP&gt;: Specify an IP address if DHCP is set as "off". Also, it depends on your ISP configuration.</p> <p>manual_dns &lt;on/off&gt;: On, set the DNS server manually; Off, use the default DNS server setting. The default is "off".</p> <p>primary_dns &lt;IP&gt;: Set the primary DNS IP (x.x.x.x) address obtained from your ISP if manual_dns is set as "on".</p> <p>secondary_dns &lt;ip&gt;: Set the secondary DNS IP (x.x.x.x) address obtained from your ISP if manual_dns is set as "on".</p> <p>specific_mccmnc &lt;on/off&gt;: Turn on or off the specific MCC and MNC.</p> <p>mcc &lt;mcc_value&gt; : Set the value (0-999) for MCC (Mobile Country Code)</p> <p>mnc &lt;mnc_value&gt;: Set the value(0-999) for MNC (Mobile Network Code).</p> <p>timeout &lt;value&gt;: Set the time out interval (50 to 255 seconds).</p> <p>fail_threshold: Set the times (2 ~ 20 times) of trying connection via LTE.</p> |
| <i>stus</i>                     | Display status of LTE connection.                                                                                                                                                                                                                                                                                                                                                                                                                                                                                                                                                                                                                                                                                                                                                                                                                                                                                                                                                                                                                                                                                                                                                                                                                                                                                                                                                                                                                                                                                                                                                                                                                 |
| <i>tag</i>                      | Set an SMS in the LTE SIM card as read state by specifying the index number. Use "all" to set all SMS as read state.                                                                                                                                                                                                                                                                                                                                                                                                                                                                                                                                                                                                                                                                                                                                                                                                                                                                                                                                                                                                                                                                                                                                                                                                                                                                                                                                                                                                                                                                                                                              |
| <i>user</i>                     | Set the UserName of LTE WAN.                                                                                                                                                                                                                                                                                                                                                                                                                                                                                                                                                                                                                                                                                                                                                                                                                                                                                                                                                                                                                                                                                                                                                                                                                                                                                                                                                                                                                                                                                                                                                                                                                      |
| <i>wms</i>                      | This command is for RD debug only. We use it to test new USB modems. Please don't use it without our advice.                                                                                                                                                                                                                                                                                                                                                                                                                                                                                                                                                                                                                                                                                                                                                                                                                                                                                                                                                                                                                                                                                                                                                                                                                                                                                                                                                                                                                                                                                                                                      |

## Example

```

> wan lte band

Access technology : LTE
Access band information : E-UTRA Op Band 3
Interfere with 2.4G WLAN : NO
Active channel: 1725
>wan lte stus
Status: Operational. (Online)
Access Tech: LTE

```

```

Band: E-UTRA Op Band 3
ISP: Chunghwa
MCC: 466, MNC: 92, LAC: 65534, Cell ID: 81023501
Max Channel TX Rate: 50000000 bps
Max Channel RX Rate: 100000000 bps
IMEI: 356318040749422
IMSI: 466924200859808
RSSI: -61 dBm
Unread SMS: 4
SMSC address: +886932400821
SMS service status : Ready
Number of SMS sent : 0

```

## Telnet Command: wan sim2

This command allows you to configure settings for SIM2. It is available for LTE model.

### Syntax

```

wan sim2 auth <0/1>
wan sim2 user <username>
wan sim2 pass <password>
wan sim2 set apn <apn_name>
wan sim2 set pin <pin_code>
wan sim2 set mode <0-3>
wan sim2 set keep_alive_on <IP>
wan sim2 set keep_alive_off
wan sim2 set timeout <50-255 sec>
wan sim2 set fail_threshold <2-20 times>

```

### Syntax Description

| Parameter                       | Description                                                                                    |
|---------------------------------|------------------------------------------------------------------------------------------------|
| <i>auth</i> <0/1>               | Set the LTE authentication for connection.<br>0 - PAP or CHAP.<br>1 - PAP only.                |
| <i>user</i> <username>          | Set the username for SIM2.<br><username> - Enter a string.                                     |
| <i>pass</i> <password>          | Set the password for SIM2.<br><password> - Enter a string.                                     |
| <i>set apn</i> <apn_name>       | Set the APN name for the SIM2.<br><apn_name> - Enter a string as APN name.                     |
| <i>set pin</i> <pin_code>       | Set the PIN code for the SIM2.                                                                 |
| <i>set mode</i> <0-3>           | Set the network mode for the SIM2.<br>0- 4G/3G/2G;<br>1- 4G Only;<br>2- 3G Only;<br>3- 2G Only |
| <i>set keep_alive_on</i> <IP>   | IP - Specify an IP address.                                                                    |
| <i>set keep_alive_off</i>       | Disable the function of Keep Alive On.                                                         |
| <i>set timeout</i> <50-255 sec> | Enter a value (50 to 255, unit is second) as the timeout.                                      |



|                                              |                                                                                                                                            |
|----------------------------------------------|--------------------------------------------------------------------------------------------------------------------------------------------|
| <i>set fail_threshold &lt;2-20 times&gt;</i> | Set the maximum times (2 to 20) of failed dial-ups. After that, the system will stop dial-up and use another SIM card for dial-up instead. |
|----------------------------------------------|--------------------------------------------------------------------------------------------------------------------------------------------|

## Example

```
> wan sim2 set timeout 100
Set dial up timeout: 100
>
```

## Telnet Command: wan detect

This command allows you to configure WAN connection detection. When Ping Detection is enabled (for Static IP or DHCP or PPPoE mode), Router pings specified IP addresses to detect the WAN connection.

### Syntax

```
wan detect <wan1../wan9><on/off/strict/always_on>
wan detect <wan1../wan9><on/off>-t<time>
wan detect <wan1../wan9> <on/off> -i<interval>
wan detect <wan1../wan9> target <ip addr>
wan detect <wan1../wan9> target2 <ip addr>
wan detect <wan1../wan9> target_gw <1/0>
wan detect <wan1../wan9> ttl <value>
wan detect <wan1../wan9> interval <interval>
wan detect <wan1../wan9> retry <retry>
wan detect status
```

### Syntax Description

| Parameter                              | Description                                                                                                                                                                                                                                                                                             |
|----------------------------------------|---------------------------------------------------------------------------------------------------------------------------------------------------------------------------------------------------------------------------------------------------------------------------------------------------------|
| <i>&lt;on/off/strict/always_on&gt;</i> | On: Enable ping detection. The IP address of the target shall be set.<br>Off: Enable ARP detection (default). Time and interval should be set.<br>strict: Enable the strict ARP detection. Time and interval should be set.<br>always_on: Disable link detect, always connected(only support static IP) |
| <i>-t &lt;time&gt;</i>                 | Set the time for ARP detect or strict ARP detection.                                                                                                                                                                                                                                                    |
| <i>-i &lt;interval&gt;</i>             | Set the interval for ARP detect or strict ARP detection.                                                                                                                                                                                                                                                |
| <i>target &lt;ip addr&gt;</i>          | Set the ping target.<br><ip addr>: It means the IP address used for detection. Type an IP address (e.g., 192.168.1.10) in this field.                                                                                                                                                                   |
| <i>target2&lt;ip addr&gt;</i>          | Set the secondary ping target.<br><ip addr>: It means the IP address used for detection. Type an IP address (e.g., 192.168.1.10) in this field.                                                                                                                                                         |
| <i>target_gw &lt;1/0&gt;</i>           | Set whether to use gateway as ping target.<br>1: yes<br>0: no<br>Note that USB WAN (PPP mode) cannot support PING gateway                                                                                                                                                                               |
| <i>ttl &lt;1-255&gt;</i>               | It means to set the ping TTL value (work as trace route)                                                                                                                                                                                                                                                |

|                            |                                                                                                                                                                                                  |
|----------------------------|--------------------------------------------------------------------------------------------------------------------------------------------------------------------------------------------------|
|                            | If you do not set any value for ttl here or just type 0 here, the system will use default setting (255) as the ttl value.                                                                        |
| <i>interval</i> <interval> | Set the interval between each ping operation. Available setting is between 1 and 3600. The unit is second.<br><interval>: Type a value.                                                          |
| <i>retry</i> <retry>       | Set how many ping operations are retried before the Router judges that the WAN connection is disconnected. Available setting is between 1 and 255. The unit is times.<br><retry>: Type a number. |
| <i>status</i>              | It means to show the current status.                                                                                                                                                             |

### Example

```
> wan detect status
WAN1: arp detect, send time=30, Interval = 5
WAN2: arp detect, send time=30, Interval = 5
WAN3: arp detect, send time=30, Interval = 5
WAN4: arp detect, send time=30, Interval = 5
WAN5: arp detect, send time=30, Interval = 5
WAN6: arp detect, send time=30, Interval = 5
WAN7: ping detect, Target=0.0.0.0, TTL=255, Target2=0.0.0.0, TargetGW=off,
Interval=1, Retry=10
WAN8: ping detect, Target=0.0.0.0, TTL=255, Target2=0.0.0.0, TargetGW=off,
Interval=1, Retry=10
WAN9: ping detect, Target=0.0.0.0, TTL=255, Target2=0.0.0.0, TargetGW=off,
Interval=1, Retry=10>
```

### Telnet Command: wan lb

This command allows you to Enable/Disable the load balance mode for each WAN.

#### Syntax

```
wan lb <wan1/wan2/...> on
wan lb <wan1/wan2/...> off
wan lb <IP/session>
wan lb status
```

#### Syntax Description

| Parameter           | Description                                             |
|---------------------|---------------------------------------------------------|
| <i>wan1 to wanx</i> | Specify which WAN will be applied with load balance.    |
| <i>on</i>           | Make WAN interface as the member of load balance.       |
| <i>off</i>          | Cancel WAN interface as the member of load balance.     |
| <i>ip/session</i>   | Set the load balance in IP-based or session-based mode. |
| <i>status</i>       | Show the current status.                                |

### Example

```
> wan lb status
WAN1: on
WAN2: on
WAN3: on
WAN4: on
WAN5: on
```

```

WAN6 : on
WAN7 : on
WAN8 : on
WAN9 : on
Load balance mode is IP based

```

## Telnet Command: wan lbel

This command allows you to set load balance exception list.

### Syntax

```

wan lbel <idx> <enable> <protocol> <ip type> <obj_grp idx> <port> <port_end> <comment>
wan lbel status <idx>

```

### Syntax Description

| Parameter          | Description                                                                                                                                     |
|--------------------|-------------------------------------------------------------------------------------------------------------------------------------------------|
| <i>idx</i>         | Enter the index number (1 to 32) for the exception list.                                                                                        |
| <i>enable</i>      | Enter 1 (enable) or 0 (disable) the selected profile.                                                                                           |
| <i>protocol</i>    | <protocol>: Enter TCP, UDP, TCP+UDP.                                                                                                            |
| <i>ip type</i>     | Set the IP type (0, 1 or 2) for the selected profile.<br>0: Any<br>1: IP object<br>2: IP group                                                  |
| <i>obj_grp idx</i> | Enter the index number (1 to 32 for IP group; 1 to 192 for IP object).<br>If it is set with "0", then the IP type will be set as "Any".         |
| <i>port</i>        | Enter a number (0 to 65535) as starting port.<br>If it is set with "0", then the port range (1 to 65535) will not be applied with load balance. |
| <i>port_end</i>    | Enter a number (0 to 65535) as ending port (must be greater than starting port).                                                                |
| <i>comment</i>     | Enter a string (less than 11 characters) as a comment.                                                                                          |
| <i>status</i>      | Show the current status.                                                                                                                        |

### Example

```

> wan lbel 1 1 tcp 0 1 0 300 testforload
> wan lbel status 1
list[1] status:enable, protocol:tcp, IP type:any, IP idx:0, port:0~300, comment:testforload
list[2] status:enable, protocol:udp, IP type:any, IP idx:0, port:19302~19302, comment:Google STUN
list[3] status:enable, protocol:tcp+udp, IP type:any, IP idx:0, port:5060~5060, comment:SIP
list[4] status:disable, protocol:tcp, IP type:any, IP idx:0, port:80~80, comment:HTTP
list[5] status:disable, protocol:tcp, IP type:any, IP idx:0, port:443~443, comment:SSL
...

```

## Telnet Command: wan mvlan

This command allows you to configure multi-VLAN for WAN and LAN. It supports pure bridge mode (modem mode) between Ethernet WAN and LAN port 2~4.

## Syntax

wan mvlan <pvc\_no/status/save/enable/disable> <on/off/clear/tag tag\_no> <service type/vlan priority> <px ... >

wan mvlan keeptag <pvc\_no> <on/off>

## Syntax Description

| Parameter             | Description                                                                                                                                                    |
|-----------------------|----------------------------------------------------------------------------------------------------------------------------------------------------------------|
| <i>pvc_no</i>         | It means index number of PVC. There are 8 PVC, 0(Channel-1) to 7(Channel-8) allowed to be configured.<br>However, bridge mode can be set on PVC number 2 to 7. |
| <i>status</i>         | It means to display the whole Bridge status.                                                                                                                   |
| <i>save</i>           | It means to save the configuration into flash of Vigor router.                                                                                                 |
| <i>enable/disable</i> | It means to enable/disable the Multi-VLAN function.                                                                                                            |
| <i>on/off</i>         | It means to turn on/off bridge mode for the specific channel.                                                                                                  |
| <i>clear</i>          | It means to turn off/clear the port.                                                                                                                           |
| <i>tag tag_no</i>     | It means to tag a number for the VLAN.<br>-1: No need to add tag number.<br>1-4095: Available setting numbers used as tagged number.                           |
| <i>service type</i>   | It means to specify the service type for VLAN.<br>0: Normal.<br>1: IGMP.                                                                                       |
| <i>vlan priority</i>  | It means to specify the priority for the VALN setting.<br>Range is from 0 to 7.                                                                                |
| <i>px</i>             | It means LAN port. Available setting number is from 2 to 4. Port number 1 is locked for NAT usage.                                                             |
| <i>keeptag</i>        | It means Multi-VLAN packets will keep their VLAN headers to LAN.                                                                                               |

## Example

PVC 7 will map to LAN port 2/3/4 in bridge mode; service type is Normal. No tag added.

```
> wan mvlan 7 on p2 p3 p4
PVC Bridge p1 p2 p3 p4 p5 Service Type Tag Priority Keep Tag
-----
 7 ON 0 0 1 1 0 0 Normal 0(OFF) 0 OFF
>
```

## Telnet Command: wan multifno

This command allows you to specify a channel (in Multi-PVC/VLAN) to make bridge connection to a specified WAN interface.

## Syntax

wan multifno <channel #><WAN interface #>

wan multifno status

## Syntax Description

| Parameter        | Description                                                                           |
|------------------|---------------------------------------------------------------------------------------|
| <i>channel #</i> | There are several channels including VLAN and PVC.<br>Available settings are: 7 to 16 |

|                        |                                                                                  |
|------------------------|----------------------------------------------------------------------------------|
|                        | Available settings are:<br>7=Channel 7<br>...<br>16=Channel 16                   |
| <i>WAN interface #</i> | Type a number to indicate the WAN interface.<br>1= <i>WAN1</i><br>2= <i>WAN2</i> |
| <i>status</i>          | It means to display current bridge status.                                       |

### Example

```

> wan multifno 5 1
> wan multifno 7 1
% Configured channel 7 uplink to WAN1
> wan multifno status
% Channel 7 uplink ifno: 3
% Channel 8 uplink ifno: 3
% Channel 9 uplink ifno: 3
% Channel 10 uplink ifno: 3
% Channel 11 uplink ifno: 3
% Channel 12 uplink ifno: 3
% Channel 13 uplink ifno: 3
% Channel 14 uplink ifno: 3
% Channel 15 uplink ifno: 3
>

```

### Telnet Command: wan vlan

This command allows you to configure the VLAN tag of WAN1 or WAN2.

#### Syntax

```

wan vlan wan <#> tag <value>
wan vlan wan <#> <enable/disable>
wan vlan stat

```

#### Syntax Description

| Parameter                | Description                                                                                                   |
|--------------------------|---------------------------------------------------------------------------------------------------------------|
| <i>wan &lt;#&gt;</i>     | Specify which WAN interface will be tagged.                                                                   |
| <i>tag &lt;value&gt;</i> | Type a number for tagging on WAN interface.                                                                   |
| <i>enable/disable</i>    | Enable: Specified WAN interface will be tagged.<br>Disable: Disable the function of tagging on WAN interface. |
| <i>stat</i>              | Display current VLAN status.                                                                                  |

### Example

```

> wan vlan stat
% Interface      Pri      Tag      Enabled
% =====
% WAN1           0        0
% WAN2           0        0

```

```

% WAN3      0      0
% WAN4      0      0
>

```

## Telnet Command: wan phyvlan

This command is used to set VLAN tag insertion for outer tag (service) for WAN interface. WAN interfaces must be configured first before setting VLAN encapsulation.

### Syntax

```

wan phyvlan wan <#> tag <value>
wan phyvlan wan <#> pri <value>
wan phyvlan wan <#> <enable/disable>
wan phyvlan stat

```

### Syntax Description

| Parameter        | Description                                                          |
|------------------|----------------------------------------------------------------------|
| <#>              | It means WAN interface.<br>1 -4 - WAN1 ~ WAN4                        |
| tag <value>      | It means to tag a value (1 to 4095) onto the selected WAN interface. |
| pri <value>      | It means to set value (0 to 7) for priority for such VLAN tag.       |
| <enable/disable> | It means to enable / disable the VLAN tag.                           |
| stat             | Display the setting status.                                          |

### Example

```

> wan phyvlan wan 1 tag 22
% Set physical port tag to 22 for WAN1
% Set physical port tag to 22 for WAN1
% You need to reboot router making config effective
> wan phyvlan wan 1 enable
% Set physical port tag to 22 for WAN1
% Set physical port tag to 22 for WAN1
% You need to reboot router making config effective
> wan phyvlan stat ?

% Interface      Pri      Tag      Enabled
% =====
% WAN1           0        0
% WAN2           0        0
% WAN3           0        0
% WAN4           0        0
>

```

## Telnet Command: wan budget

This command allows you determine the data *traffic volume* for each WAN interface respectively to prevent from overcharges for data transmission by the ISP.

### Syntax

```

wan budget wan <#> rdate <day><hour>
wan budget wan <#> <enable/disable>

```

```

wan budget wan <#> thres <budget limit (MB)>
wan budget wan <#> gthres <budget limit (GB)>
wan budget wan <#> mode <monthly/periodic/none>
wan budget wan <#> psday <th day in periodic>
wan budget wan <#> custom_mode <0/1>
wan budget wan <#> custom_mode_reset_hour <hour>
wan budget wan <#> action <action bitmap>
wan budget status

```

## Syntax Description

| Parameter                                          | Description                                                                                                                                                                                                                                                                                                                                                                                                                                                                      |
|----------------------------------------------------|----------------------------------------------------------------------------------------------------------------------------------------------------------------------------------------------------------------------------------------------------------------------------------------------------------------------------------------------------------------------------------------------------------------------------------------------------------------------------------|
| <i>wan &lt;#&gt; rdate &lt;day&gt;&lt;hour&gt;</i> | <p>wan &lt;#&gt;: Specify the WAN interface.</p> <p><i>rdate &lt;day&gt;&lt;hour&gt;</i>: Specify the WAN budget refresh time.</p> <p>day - Available settings are from 1 to 30.</p> <p>hour - Available settings are from 1 to 23.</p> <p>E.g., wan budget wan 1 rdate 5 10</p> <p>If monthy mode is selected: WAN budget will be refreshed on 5th day at 10:00 in each month.</p> <p>If periodic mode is selected: WAN budget will be refreshed every 5 days and 10 hours.</p> |
| <i>&lt;enable/disable&gt;</i>                      | <p>enable - Enable the function of wan budget.</p> <p>disable - Disable the function of wan budget.</p>                                                                                                                                                                                                                                                                                                                                                                          |
| <i>thres &lt;budget limit (MB)&gt;</i>             | Specify the maximum value for WAN budget limit. (Unit: MB)<br>budget limit - Type a number.                                                                                                                                                                                                                                                                                                                                                                                      |
| <i>gthres &lt;budget limit (GB)&gt;</i>            | Specify the maximum value of wan budget limit. (Unit: GB)<br>budget limit - Type a number.                                                                                                                                                                                                                                                                                                                                                                                       |
| <i>mode &lt;monthly/periodic/none&gt;</i>          | Specify the calculation mode (monthly, periodically, or none) for WAN budget.                                                                                                                                                                                                                                                                                                                                                                                                    |
| <i>psday &lt;th day in periodic&gt;</i>            | <p>It is used only when mode is set with “periodic”. Specify the order of “today” in the cycle.</p> <p>E.g., wan budget wan 5 psday → It means “today” is the 5<sup>th</sup> day in the billing cycle.</p>                                                                                                                                                                                                                                                                       |
| <i>custom_mode &lt;0/1&gt;</i>                     | <p>Set the custom mode ( cycle in hours or in days).</p> <p>0: cycle_in_hours</p> <p>1: cycle_in_days</p>                                                                                                                                                                                                                                                                                                                                                                        |
| <i>custom_mode_reset_hour &lt;hour&gt;</i>         | <p>Set the reset hour value.</p> <p>hour: Enter 1 to 23.</p>                                                                                                                                                                                                                                                                                                                                                                                                                     |
| <i>action &lt;action bitmap&gt;</i>                | <p>Determine the action to be performed when it reaches the WAN budget limit.</p> <p><i>action bitmap</i> - Type a total number of actions to be executed. Different numbers represent different actions.</p> <p>1: shutdown wan</p> <p>2: send mail alert</p> <p>4: send sms alert</p> <p>For example, if you type “5” (5=1+4), the system will send SMS alert when WAN shutdown is detected.</p>                                                                               |
| <i>status</i>                                      | Display current configuration status of WAN budget.                                                                                                                                                                                                                                                                                                                                                                                                                              |

## Example

```

> wan budget wan 1 action 5
% WAN 1 budget action set to 5

```

```
> wan budget wan 1 gthres 10
% WAN 1 budget limit set to 10 GB
```

## Telnet Command: wan detect\_mtu

This command allows you to run a WAN MTU Discovery. The user can specify an IPv4 target to ping and find the suitable MTU size of the WAN interface.

### Syntax

```
wan detect_mtu -i <Host/IP address> -s <mtu_size> -d <decrease size> -w <WAN number> -c <1-10>
```

### Syntax Description

| Parameter            | Description                                                                                                                                      |
|----------------------|--------------------------------------------------------------------------------------------------------------------------------------------------|
| -i <Host/IP address> | Specify the IPv4 target to detect. It can be an IPv4 address or domain name.<br>Host/IP address: Enter the IP address/domain name of the target. |
| -s <mtu_size>        | Set the MTU size base for Discovery.<br>base_size: Available setting is 1000 - 1500.                                                             |
| -d <decrease size>   | Set the MTU size to decrease between detections.<br>decrease size: Available setting is 1 - 100.                                                 |
| -w <wan number>      | Specify the WAN interface.<br>Value: Enter the number of WAN interface. 1: WAN1; 2:WAN2....and etc.                                              |
| -c <value>           | Set the maximum times of ping failure during a Discovery.<br>count: Available settings are 1 - 10. Default value is 3.                           |

### Example

```
> wan detect_mtu -w 2 -i 8.8.8.8 -s 1500 -d 30 -c 10
detecting mtu size:1500!!!

mtu size:1470!!!
```

## Telnet Command: wan detect\_mtu6

This command allows you to run a WAN MTU Discovery. The user can specify an IPv6 target to ping and find the suitable MTU size of the WAN interface.

### Syntax

```
wan detect_mtu6 -i <Host/IP address> -s <mtu_size> -w <WAN number>
```

### Syntax Description

| Parameter              | Description                                                                                                                          |
|------------------------|--------------------------------------------------------------------------------------------------------------------------------------|
| -i <host/IPv6 address> | Specify the IPv6 target to detect. It must be an IPv6 IP address or host name.<br>IPv6 address: Type the IPv6 address of the target. |
| -s <base_size>         | Specify the size of MTU.<br>base_size: Available setting is 1280 - 1500.                                                             |
| -w <number>            | Specify the WAN interface<br>number: Enter the number of WAN interface. 1: WAN1; 2:WAN2....and etc.                                  |



## Example

```
> wan detect_mtu6 -w 2 -i 2404:6800:4008:c06::5e -s 1500
>
```

## Telnet Command: wan failover

This command is used to configure failover WAN.

### Syntax

```
wan failover off <index>
wan failover on <1><2><3><4><5><6>
wan failover show <index>
wan failover newlb <index><arg>
```

### Syntax Description

| Parameter                                | Description                                                                                                                                                                                                                                                                                                                                                                                                                                                                                                                                                                                                                                                                                                                                                                                                                                                                                                                                                                                                         |
|------------------------------------------|---------------------------------------------------------------------------------------------------------------------------------------------------------------------------------------------------------------------------------------------------------------------------------------------------------------------------------------------------------------------------------------------------------------------------------------------------------------------------------------------------------------------------------------------------------------------------------------------------------------------------------------------------------------------------------------------------------------------------------------------------------------------------------------------------------------------------------------------------------------------------------------------------------------------------------------------------------------------------------------------------------------------|
| <i>failover off</i> <index>              | Set specified WAN interface to always on.<br>index - Ranges from 1 to 6.                                                                                                                                                                                                                                                                                                                                                                                                                                                                                                                                                                                                                                                                                                                                                                                                                                                                                                                                            |
| <i>failover on</i><br><1><2><3><4><5><6> | There are six fields which represent different options.<br>Field 1 - Specify WAN interface as failover WAN by typing 1 to 4.<br>Field 2 - Enable / disable the action for the failover WAN. Such action is "Active When selected WAN [disconnect/reached traffic threshold]".<br>0 - Disable<br>1 - Enable<br>Field 3 - Enable / disable the action for the failover WAN. Such action is "Active When [any/all] of selected WAN disconnect or reached traffic threshold".<br>0 - Disable<br>1 - Enable<br>Field 4 - Specify main WAN by typing 1 to 4. The main WAN will be set to always on.<br>Field 5 - Specify traffic threshold [Download threshold(Kbps)].<br>Field 6 - Specify traffic threshold [Upload threshold (Kbps)].<br>For example, WAN 2 will be set as failover, and will be active when any of selected WANs has reached traffic threshold. WAN 4 is the selected WAN. Download threshold : 50 Kbps; Upload threshold : 20 Kbps. You can type as follows:<br><i>wan failover on 2 1 0 4 50 20</i> |
| <i>show</i> <index>                      | Display parameters settings for WAN interface.<br>index - Ranges from 1 to 6.                                                                                                                                                                                                                                                                                                                                                                                                                                                                                                                                                                                                                                                                                                                                                                                                                                                                                                                                       |
| <i>newlb</i> <index><arg>                | Set the latency, jitter, packet loss threshold of the WAN interface.<br>index - 1 to 6<br>arg - lists as follows:<br>-a [all] : 0=any meet, 1=all meet.<br>-u [check] : 0=n/a, 1=check upload.<br>-d [check] : 0=n/a, 1=check download.<br>-l [check] : 0=n/a, 1=check latency.<br>-j [check] : 0=n/a, 1=check jitter.<br>-p[check] : 0=n/a, 1=check packet loss.<br>-m[value] : upload threshold value.                                                                                                                                                                                                                                                                                                                                                                                                                                                                                                                                                                                                            |

|  |                                                                                                                                                                      |
|--|----------------------------------------------------------------------------------------------------------------------------------------------------------------------|
|  | -n [value] : download threshold value.<br>-x [value] : latency threshold value.<br>-y [value] : jitter threshold value.<br>-z [value] : packet loss threshold value. |
|--|----------------------------------------------------------------------------------------------------------------------------------------------------------------------|

## Example

```
> wan failover on 2 1 0 4 50 20
> wan failover show 2
wan2 Active Mode : Failover
Active when : Any of the selected WANs reached the Traffic
Threshold, any
followed meet:
>
```

## Telnet Command: hsportal setup

This command is used to configure a profile (Hotspot Web Portal) with specified URL for accessing into or display a message when a wireless/LAN user connects to Internet through this router.

### Syntax

hsportal setup -p <profile> [-l <lan>] [-s <ssid>] ...

hsportal setup -p <profile> -c

### Syntax Description

| Parameter    | Description                                                                                                                   |
|--------------|-------------------------------------------------------------------------------------------------------------------------------|
| -p <profile> | Indicate available profile to be configured.<br><profile>: Enter the index number (1 to 4) of the profile.                    |
| -l           | Apply to LAN interfaces (1 to 8).<br>For example: hsportal setup -p 1 -l 1, 2 (apply LAN1 and LAN2)                           |
| -s           | Apply to WLAN interfaces (1 to 4).<br>For example: hsportal setup -p 1 -s 1, 2 (apply SSID1 and SSID2)                        |
| -a           | Apply to WLAN5G interfaces (1 to 4).<br>For example: hsportal setup -p 1 -a 1, 2 (apply SSID1 and SSID2)                      |
| -m           | Select login mode.<br>0: skip<br>1: click<br>2: social<br>3: pin<br>4: social or pin<br>For example: hsportal setup -p 1 -m 0 |
| -f <0/1>     | It menas to enable or disable the function of Configure facebook login.<br>0: disable.<br>1: enable.                          |
| -g <0/1>     | It menas to enable or disable the function of Configure google login.<br>0: disable.<br>1: enable.                            |
| -h <0/1>     | It menas to enable or disable the function of HTTPS redirection.<br>0: disable.                                               |

|                                 |                                                                                                                                                                                                                                                            |
|---------------------------------|------------------------------------------------------------------------------------------------------------------------------------------------------------------------------------------------------------------------------------------------------------|
|                                 | 1: enable.                                                                                                                                                                                                                                                 |
| <code>-v &lt;0/1&gt;</code>     | It means to enable or disable the function of portal detection.<br>0: disable.<br>1: enable.                                                                                                                                                               |
| <code>-i &lt;string&gt;</code>  | It means to set APP ID.<br><string>: Enter a string as APP ID.<br>For example, to configure facebook APP id, you can type:<br>> hsportal set -p 1 -f 1 -i this_is_app_id<br>Profile 1 set facebook login enabled ... [OK]<br>Profile 1 set API ID ... [OK] |
| <code>-k &lt;string&gt;</code>  | It means to set APP key.<br><string>: Enter a string as APP key.<br>For example, to configure google APP key, you can type:<br>> hsportal set -p 1 -g 1 -k keyforapp<br>Profile 1 set google login enabled ... [OK]<br>Profile 1 set API KEY ... [OK]      |
| <code>-r &lt;0/1/2&gt;</code>   | It means to set landing page mode.<br>0: fixed URL.<br>1: user request.<br>2: bulletin.<br>For example,<br>> hsportal set -p 1 -r 0<br>Profile 1 set landing page mode 0 ... [OK]                                                                          |
| <code>-e</code>                 | Enable the specified profile.                                                                                                                                                                                                                              |
| <code>-d</code>                 | Disable the specified profile.                                                                                                                                                                                                                             |
| <code>-c &lt;1/2/3/4&gt;</code> | Reset the specified profile.<br><1/2/3/4>: Enter the index number of profile.<br>For example,<br>> hsportal set -p 1 -c<br>Reset profile 1 ... [OK]                                                                                                        |
| <code>-o</code>                 | Clear profiles for all clients.                                                                                                                                                                                                                            |
| <code>-t &lt;value&gt;</code>   | Set the expire time for the specified profile.<br><value>: Enter a number of time period (unit: minutes).<br>For example,<br>k> hsportal setup -p 1 -t 300<br>Profile 1 set expire time 300 mins ... [OK]                                                  |

## Example

```

> hsportal setup -p 1 -c
Reset profile 1 ... [OK]
> hsportal setup -p 1 -r 0
Profile 1 set landing page mode 0 ... [OK]
> hsportal setup -p 2 -g 1 -k app_key_google
Profile 2 set google login enabled ... [OK]
Profile 2 set API KEY ... [OK]
>

```

## Telnet Command: hsportal info

This command allows the user to configure settings for hotspot database.

## Syntax

hsportal info <-e /-c /-n /-a /-m /-s>

## Syntax Description

| Parameter  | Description                                                                                                                                                         |
|------------|---------------------------------------------------------------------------------------------------------------------------------------------------------------------|
| -e <0/1>   | It means to enable or disable the database to record information.<br>0: disable.<br>1: enable.                                                                      |
| -c         | It means to clear User information database.                                                                                                                        |
| -n <0/1>   | It means to enable or disable the notification for user information.<br>0: disable.<br>1: enable.                                                                   |
| -a <0/1>   | It means to enable or disable the function of auto backup and start a new record for user information.<br>0: disable.<br>1: enable.                                 |
| -m <value> | It means to set email notification object.<br><value>: Enter the index number (1 to 10) of email notification objects.                                              |
| -s <value> | It means to set SMS provider object.<br><value>: Enter the index number (1 to 10) of the SMS server object for sending mail out when the database storage exceeded. |

## Example

```
> hsportal info -e 1
Enabled database to record information ... [OK]
> hsportal info -n 1
Enabled notification for user information ... [OK]
> hsportal info -a 1
Enabled auto backup and start a new record for user information ... [OK]
> hsportal info -m 1
Email notification object set ok.
>
```

## Telnet Command: hsportal level

This command allows the user to configure bandwidth and sessions quota which is only applicable to the web portal clients.

## Syntax

hsportal level -p <index> [-e <enable>] [-t <mins>] ...

## Syntax Description

| Parameter  | Description                                                                                                                 |
|------------|-----------------------------------------------------------------------------------------------------------------------------|
| -p <index> | It means to specify (add) a quota policy profile.<br><index>: Enter the index number (1 to 20) of the quota policy profile. |
| -e <0/1>   | It means to enable or disable the quota policy profile.<br>0: disable.<br>1: enable.                                        |

|                                              |                                                                                                                                                                                                                                                      |
|----------------------------------------------|------------------------------------------------------------------------------------------------------------------------------------------------------------------------------------------------------------------------------------------------------|
| <code>-t &lt;value&gt;</code>                | It means to set expired time for quota policy.<br><value>: Enter a number (unit:minutes).                                                                                                                                                            |
| <code>-i &lt;0/1&gt; -o &lt;value&gt;</code> | It means to enable or disable the function of idle timeout<br>0: disable.<br>1: enable.<br>If enabled,<br>-o <value>: Set the idle timeout (unit:minutes) if idle timeout is enabled.<br>For example: hportal level -p 1 -e 1 -i 1 -o 300            |
| <code>-d &lt;value&gt;</code>                | It means to set the maximum number of devices that can be connected to the network using the same account.<br><value>: Enter a number (0 to 100). "0" means unlimited.<br>For example: hportal level -p 1 -e 1 -d 0                                  |
| <code>-b &lt;0/1&gt;</code>                  | It means to enable or disable the function of bandwidth limit.<br>0: disable.<br>1: enable.                                                                                                                                                          |
| <code>-ru &lt;0/1&gt;</code>                 | It means to specify the bandwidth limit download unit.<br>0: kbps<br>1: mbps                                                                                                                                                                         |
| <code>-tu &lt;0/1&gt;</code>                 | It means to specify the bandwidth limit upload unit.<br>0: kbps.<br>1: mbps.                                                                                                                                                                         |
| <code>-s &lt;0/1&gt;</code>                  | It means to enable or disable the session limit.<br>0:disable.<br>1:enable.                                                                                                                                                                          |
| <code>-n &lt;value&gt;</code>                | It means to set a maximum session limit.<br><value>: Enter a value (0 to 6000).<br>For example: hportal level -p 1 -s 1 -n                                                                                                                           |
| <code>-U &lt;kbps/mbps&gt;</code>            | It means to specify the bandwidth upload limit.<br>kbps<br>mbps                                                                                                                                                                                      |
| <code>-D &lt;kbps/mbps&gt;</code>            | It means to specify the bandwidth download limit.<br>kbps<br>mbps                                                                                                                                                                                    |
| <code>-c &lt;index&gt;</code>                | It means to delete a quota policy profile.<br><index>: Enter the index number (1 to 20) of the quota policy profile.                                                                                                                                 |
| <code>-r &lt;0/1&gt;</code>                  | It means to enable or disable the function of reconnection time restriction.<br>0:disable.<br>1:enable.                                                                                                                                              |
| <code>-f &lt;value&gt;</code>                | It means to set a period of time to block the same user reconnecting to the network.<br><value>: Enter a number (1 to 1439 minutes).<br>For example: hportal level -p 1 -e 1 -r 1 -f 300                                                             |
| <code>-g &lt;value&gt;</code>                | It means to set a reconnection time to block the same user from reconnecting before the set time.<br><value>: Enter the hour (01 to 23) and the minutes (0-59) (unit: minutes).<br>For example: hportal level -p 1 -e 1 -r 1 -f 23:15 (The same user |

---

---

|                                      |
|--------------------------------------|
| can reconnect after 23:15 every day) |
|--------------------------------------|

---

---

## Example

```
> hsportal level -p 1 -e 1 -r 1 -f 30000
>
```

## Telnet Command: hsportal pin\_gen

This command is for future use.

## Telnet Command: hsportal json\_pin\_gen

This command allows the user to configure JSON settings for getting the PIN code.

### Syntax

```
json_pin_gen <enable/disable/status>
json_pin_gen authCode <authCode>
json_pin_gen ipFilter <enable/disable/status>
json_pin_gen ipv4Filter <FilterIdx> <obj> <ObjIndex>
json_pin_gen ipv6Filter <FilterIdx> <obj> <ObjIndex>
json_pin_gen ipv4Filter <FilterIdx> clear
json_pin_gen ipv6Filter <FilterIdx> clear
json_pin_gen AccFromInternet <enable/disable/status>
```

### Syntax Description

| Parameter                                                                                         | Description                                                                                                                                                                                                                                      |
|---------------------------------------------------------------------------------------------------|--------------------------------------------------------------------------------------------------------------------------------------------------------------------------------------------------------------------------------------------------|
| <i>json_pin_gen</i><br><i>&lt;enable/disable/status&gt;</i>                                       | It means to enable/disable the function of JSON get pin code.                                                                                                                                                                                    |
| <i>json_pin_gen authCode</i><br><i>&lt;authCode&gt;</i>                                           | It means to set authentication code for JSON pin code mechanism.<br><authCode> - Enter a string as identity authentication.                                                                                                                      |
| <i>json_pin_gen ipFilter</i><br><i>&lt;enable/disable/status&gt;</i>                              | It means to enable/disable the authentication based on the IPv4 or IPv6 object.                                                                                                                                                                  |
| <i>json_pin_gen ipv4Filter</i><br><i>&lt;FilterIdx&gt; &lt;obj&gt;</i><br><i>&lt;ObjIndex&gt;</i> | It means to set IPv4 object for authentication.<br><FilterIdx> - Specify the index number of the IPv4 object profile.<br><obj> - Ranges from 1 to 10. Ten objects can be set.<br><ObjIndex> - Enter the index number of the IPv4 object profile. |
| <i>json_pin_gen ipv6Filter</i><br><i>&lt;FilterIdx&gt; &lt;obj&gt;</i><br><i>&lt;ObjIndex&gt;</i> | It means to set IPv6 object for authentication.<br><FilterIdx> - Specify the index number of the IPv6 object profile.<br><obj> - Ranges from 1 to 10. Ten objects can be set.<br><ObjIndex> - Enter the index number of the IPv6 object profile. |
| <i>json_pin_gen ipv4Filter</i><br><i>&lt;FilterIdx&gt; clear</i>                                  | It means to clear IPv4 object filter.<br><FilterIdx> - Specify the index number of the IPv4 object profile.                                                                                                                                      |

|                                                                                       |                                                                                                             |
|---------------------------------------------------------------------------------------|-------------------------------------------------------------------------------------------------------------|
| <i>json_pin_gen ipv6Filter</i><br><i>&lt;Filteridx&gt; clear</i>                      | It means to clear IPv6 object filter.<br><Filteridx> - Specify the index number of the IPv6 object profile. |
| <i>json_pin_gen</i><br><i>AccFromInternet</i><br><i>&lt;enable/disable/status&gt;</i> | It means to set Generate pin code From Internet mechanism.                                                  |

## Example

```
> hsportal json_pin_gen enable
  json get pincode mechanism : enable
> hsportal json_pin_gen authCode passcode1
  Set the authCode
```

## Telnet Command: wl acl

This command allows the user to configure wireless access control settings.

### Syntax

```
wl acl enable <ssid1 ssid2 ssid3 ssid4>
wl acl disable <ssid1 ssid2 ssid3 ssid4>
wl acl add <MAC><ssid1 ssid2 ssid3 ssid4><comment><isolate>
wl acl del <MAC>
wl acl mode <ssid1 ssid2 ssid3 ssid4><white/black>
wl acl show
wl acl showmode
wl acl clear
```

### Syntax Description

| Parameter                                                                           | Description                                                                                                                                                                                                                                                                               |
|-------------------------------------------------------------------------------------|-------------------------------------------------------------------------------------------------------------------------------------------------------------------------------------------------------------------------------------------------------------------------------------------|
| <i>enable &lt;ssid1 ssid2 ssid3 ssid4&gt;</i>                                       | It means to enable the settings for SSID1, SSID2, SSID3 and SSID4.                                                                                                                                                                                                                        |
| <i>disable &lt;ssid1 ssid2 ssid3 ssid4&gt;</i>                                      | It means to disable the settings for SSID1, SSID2, SSID3 and SSID4.                                                                                                                                                                                                                       |
| <i>add &lt;MAC&gt;&lt;ssid1 ssid2 ssid3 ssid4&gt;&lt;comment&gt;&lt;isolate&gt;</i> | It means to associate a MAC address to certain SSID interfaces' access control settings. The isolate setting will limit the wireless client's network capabilities to accessing the wireless LAN only.<br>[MAC] format: xx-xx-xx-xx-xx-xx<br>or xx:xx:xx:xx:xx:xx<br>or xx.xx.xx.xx.xx.xx |
| <i>del&lt;MAC&gt;</i>                                                               | It means to delete a MAC address entry defined in the access control list.                                                                                                                                                                                                                |
| <i>mode &lt;ssid1 ssid2 ssid3 ssid4&gt;&lt;white/black&gt;</i>                      | It means to set white/black list for each SSID.                                                                                                                                                                                                                                           |
| <i>show</i>                                                                         | It means to show access control status.                                                                                                                                                                                                                                                   |
| <i>showmode</i>                                                                     | It means to show the mode for each SSID.                                                                                                                                                                                                                                                  |
| <i>clear</i>                                                                        | It means to clean all access control setting.                                                                                                                                                                                                                                             |

## Example

```

> wl acl showmode
  ssid1: none
  ssid2: none
  ssid3: none
  ssid4: none
> wl acl add 14:49:BC:0D:8F:00 ssid1 ssid2 test isolate
  Set Done !!
> wl acl show
-----Mac Address Filter Status-----
  SSID1: Disable
  SSID2: Disable
  SSID3: Disable
  SSID4: Disable

-----MAC Address List-----
  Index   Attribute      MAC Address      Associated SSIDs      Comment
    1       s             14:49:bc:0d:8f:00  SSID1 SSID2          test

  s: Isolate the station from LAN
>

```

## Telnet Command: wl config

This command allows users to configure general settings and security settings for wireless connection.

### Syntax

```

wl config mode <value>
wl config mode show
wl config channel <number>
wl config channel show
wl config preamble <enable>
wl config txburst <enable>
wl config ssid <ssid_num enable ssid_name <hidden_ssid>>
wl config security <SSID_NUMBER><mode>
wl config ratectl <ssid_num enable upload download >
wl config isolate <ssid_num lan member>
wl config dtim <value>/ show
wl config beaconperiod <value> / show
wl config radio <1/0>/show
wl config frag <value>/ show
wl config rts <value> / show
wl config rate_alg <value> / show
wl config country <value> / show

```

### Syntax Description

| Parameter               | Description                                                                                                                          |
|-------------------------|--------------------------------------------------------------------------------------------------------------------------------------|
| <i>mode</i> <value>     | It means to select connection mode for wireless connection. Available settings are: "11bgn", "11gn", "11n", "11bg", "11g", or "11b". |
| <i>mode show</i>        | It means to display what the current wireless mode is.                                                                               |
| <i>channel</i> <number> | It means the channel of frequency of the wireless LAN.                                                                               |



|                                                                          |                                                                                                                                                                                                                                                                                                                                                                                                                                                                                                                                                                                                                                                                                                                                                                                                                                                                                     |
|--------------------------------------------------------------------------|-------------------------------------------------------------------------------------------------------------------------------------------------------------------------------------------------------------------------------------------------------------------------------------------------------------------------------------------------------------------------------------------------------------------------------------------------------------------------------------------------------------------------------------------------------------------------------------------------------------------------------------------------------------------------------------------------------------------------------------------------------------------------------------------------------------------------------------------------------------------------------------|
|                                                                          | <p>The available settings are 0,1,2,3,4,5,6,7,8,9,10,11,12 and 13.</p> <p>number=0, means Auto</p> <p>number=1, means Channel 1</p> <p>....</p> <p>number=13, means Channel 13.</p>                                                                                                                                                                                                                                                                                                                                                                                                                                                                                                                                                                                                                                                                                                 |
| <i>preamble &lt;enable&gt;</i>                                           | <p>It means to define the length of the sync field in an 802.11 packet. Most modern wireless network uses short preamble with 56 bit sync field instead of long preamble with 128 bit sync field. However, some original 11b wireless network devices only support long preamble.</p> <p>0: disable to use long preamble.</p> <p>1: enable to use long preamble.</p>                                                                                                                                                                                                                                                                                                                                                                                                                                                                                                                |
| <i>txburst &lt;enable&gt;</i>                                            | <p>It means to enhance the performance in data transmission about 40%* more (by enabling Tx Burst). It is active only when both sides of Access Point and Station (in wireless client) invoke this function at the same time.</p> <p>0: disable the function.</p> <p>1: enable the function.</p>                                                                                                                                                                                                                                                                                                                                                                                                                                                                                                                                                                                    |
| <i>ssid &lt;ssid_num enable ssid_name &lt;hidden_ssid&gt;&gt;</i>        | <p>It means to set the name of the SSID, hide the SSID if required.</p> <p><i>ssid_num</i>: Type 1, 2, 3 or 4 to specify SSID1, SSID2, SSID3 or SSID4.</p> <p><i>ssid_name</i>: Give a name for the specified SSID.</p> <p><i>hidden_ssid</i>: Type 0 to hide the SSID or 1 to display the SSID</p>                                                                                                                                                                                                                                                                                                                                                                                                                                                                                                                                                                                 |
| <i>security &lt;SSID_NUMBER&gt;&lt;mode&gt;&lt;key &gt;&lt;index&gt;</i> | <p>It means to configure security settings for the wireless connection.</p> <p><i>SSID_NUMBER</i>: Type 1, 2, 3 or 4 to specify SSID1, SSID2, SSID3 or SSID4.</p> <p><i>mode</i>: Available settings are:</p> <p>disable: No security.</p> <p>wpa1x: WPA/802.1x Only</p> <p>wpa21x: WPA2/802.1x Only</p> <p>wpamix1x: Mixed (WPA+WPA2/802.1x only)</p> <p>wep1x: WEP/802.1x Only</p> <p>wpa2psk: WPA/PSK</p> <p>wpa2psk: WPA2/PSK</p> <p>wpamixpsk: Mixed (WPA+WPA2)/PSK</p> <p>wep: WEP</p> <p><i>key, index</i>: Moreover, you have to add keys for <i>wpa2psk</i>, <i>wpa2psk</i>, <i>wpamixpsk</i> and <i>wep</i>, and specify index number of schedule profiles to be followed by the wireless connection.</p> <p>WEP keys must be in 5/13 ASCII text string or 10/26 Hexadecimal digit format; WPA keys must be in 8-63 ASCII text string or 64 Hexadecimal digit format.</p> |
| <i>ratectl &lt;ssid_num enable upload download&gt;</i>                   | <p>It means to set the rate control for the specified SSID.</p> <p><i>ssid_num</i>: Choose 1, 2, 3 or 4 to specify SSID1, SSID2, SSID3 or SSID4.</p> <p><i>enable</i>: It means to enable the function of the rate control for the specified SSID. 0: disable and 1:enable.</p> <p><i>upload</i>: It means to configure the rate control for data upload. The unit is kbps.</p> <p><i>download</i>: It means to configure the rate control for data download. The unit is kbps.</p>                                                                                                                                                                                                                                                                                                                                                                                                 |
| <i>isolate &lt;ssid_num lan member&gt;</i>                               | <p>It means to isolate the wireless connection for LAN and/or Member.</p> <p><i>lan</i> - It can make the wireless clients (stations) with remote-dial and LAN to LAN users not accessing for each other.</p> <p><i>member</i> - It can make the wireless clients (stations) with the same SSID not accessing for each other.</p>                                                                                                                                                                                                                                                                                                                                                                                                                                                                                                                                                   |

|                                          |                                                                                                                            |
|------------------------------------------|----------------------------------------------------------------------------------------------------------------------------|
| <i>dtim &lt;value&gt; / show</i>         | Set the DTIM value.<br>value: 1 to 255<br>show: Display the DTIM setting.                                                  |
| <i>beaconperiod &lt;value&gt; / show</i> | Set the beaconperiod value.<br>value: 20 to 1023 (milli-second)<br>show: Display the beaconperiod etting.                  |
| <i>radio &lt;1/0&gt;/show</i>            | Enble or disable the wireless radio.<br>1/0: Type 1 to enable; 0 to disable.<br>show: Display the radio setting.           |
| <i>frag &lt;value&gt;/ show</i>          | Set the fragment value.<br>value: 256 to 2346<br>show: Display the fragment setting.                                       |
| <i>rts &lt;value&gt; / show</i>          | Set the RTS value.<br>value: 1 to 2347<br>show: Display the RTS setting.                                                   |
| <i>rate_alg &lt;value&gt;/ show</i>      | Set the algorithm for ALG rate.<br>value: 0 for old algorithm; 1 for new algorithm.<br>show: Display the ALG rate setting. |
| <i>country &lt;value&gt;/ show</i>       | Set the country code for a country.<br>value: two capital letters, e.g., TW, UK<br>show: Display the country cod setting.  |

## Example

```

> wl config mode 11bgn
Current mode is 11bgn
% <Note> Please restart wireless after you set the channel
> wl config channel 13
Current channel is 13
% <Note> Please restart wireless after you set the channel.
> wl config preamble 1
Long preamble is enabled
% <Note> Please restart wireless after you set the parameters.
> wl config ssid 1 enable dray
SSID Enable Hide_SSID Name
1 1 0 dray
% <Note> Please restart wireless after you set the parameters.
> wl config security 1 wpa1x
%% Configured Wlan Security Setting:
% SSID1
%% Mode: wpa1x
%% Wireless card must be reset for configurations to take effect
%% (Telnet Command: wl restart)
> wl config country TW
Set wireless country code TW
% <Note> Please restart wireless after you set the parameters.

```

## Telnet Command: wl set

This command allows users to configure basic wireless settings.

## Syntax

wl set <SSID><CHAN[En]>

wl set txburst <enable>

## Syntax Description

| Parameter                     | Description                                                                                                                                                                                                                                                                       |
|-------------------------------|-----------------------------------------------------------------------------------------------------------------------------------------------------------------------------------------------------------------------------------------------------------------------------------|
| <i>SSID</i>                   | It means to Enter the SSID for the router. The maximum character that you can use is 32.                                                                                                                                                                                          |
| <i>CHAN[En]</i>               | It means to specify required channel for the router.<br><i>CHAN</i> : The range for the number is between 1 - 13.<br><i>En</i> : type <i>on</i> to enable the function; type <i>off</i> to disable the function.                                                                  |
| <i>txburst &lt;enable&gt;</i> | It means to enhance the performance in data transmission about 40%* more (by enabling Tx Burst). It is active only when both sides of Access Point and Station (in wireless client) invoke this function at the same time.<br>0: disable the function.<br>1: enable the function. |

## Example

```
> wl set MKT 2 on
% New Wlan Setting is:
% SSID=MKT
% Chan=2
% Wl is Enable
```

## Telnet Command: wl act

This command allows users to activate wireless settings.

## Syntax

wl act <En>

## Syntax Description

| Parameter | Description                                                                            |
|-----------|----------------------------------------------------------------------------------------|
| <i>En</i> | It means to enable or disable the function of VPN isolation.<br>0: diable<br>1: enable |

## Example

```
> wl act on
% Set Wlan to Enable.
```

## Telnet Command: wl scan

This command allows users to perform AP scanning.

## Syntax

wl scan <start>

wl scan set <wlist/blist> <MAC>

wl scan set <stime> <time>

wl scan del <wlist/blist><MAC>

wl scan *filter* <ssid/channel/mac>  
 wl scan *show* <0/1/2/3/4/5>

### Syntax Description

| Parameter                        | Description                                                                                                                                                                                                                                                                          |
|----------------------------------|--------------------------------------------------------------------------------------------------------------------------------------------------------------------------------------------------------------------------------------------------------------------------------------|
| <i>start</i>                     | It means to start AP scanning.                                                                                                                                                                                                                                                       |
| <i>set</i> <wlist/blist> <MAC>   | Set white list/block list/scan time.<br><i>wlist</i> - It means to set white list for passing. MAC address must be added in the end.<br>e.g., <i>wl scan set wlist 001122aabbcc</i><br><i>blist</i> - It means to set black list for blocking. MAC address must be added in the end. |
| <i>set</i> <stime> <time>        | Set the scan time.<br><i>stime</i> - It means to set scanning time.<br><i>time</i> - Time value (2-5 second) must be added in the end.<br>e.g., <i>wl scan set time 5</i>                                                                                                            |
| <i>del</i> <wlist/blist><MAC>    | Remove white list/block list.<br>e.g., <i>wl scan del wlist 001122aabbcc</i>                                                                                                                                                                                                         |
| <i>filter</i> <ssid/channel/mac> | Set which filter you want.<br><i>ssid</i> - scanning the AP based on SSID setting.<br><i>channel</i> - scanning the AP based on channel setting.<br><i>mac</i> - scanning the AP based on MAC address setting..                                                                      |
| <i>show</i> <0/1/2/3/4/5>        | It is used to show AP list.<br>0 - display white list<br>1 - display block list,<br>2 - display gray/unknown list,<br>3 - display all list<br>4. white list(in config)<br>5. block list(in config)<br>Note : 0-3 is the list router scan, 4-5 is the list stored in config.          |

### Example

```
> wl scan set wlist 001122aabbcc
> wl scan start
> wl scan show 3
>
```

### Telnet Command: wl stamgt

This command is used to configure connection time and reconnection time for each SSID that wireless client used for accessing into Internet.

### Syntax

wl stamgt <enable/disable> <ssid\_num>  
 wl stamgt *show* <ssid\_num>  
 wl stamgt *set* <ssid\_num> <c> <r>  
 wl stamgt *reset* <ssid\_num>

### Syntax Description

| Parameter | Description |
|-----------|-------------|
|-----------|-------------|

|                       |                                                                                                          |
|-----------------------|----------------------------------------------------------------------------------------------------------|
| <i>enable/disable</i> | It means to enable/disable the station management control.                                               |
| <i>ssid_num</i>       | It means channel selection.<br>Available channel for 2.4G: 0/1/2/3<br>Available channel for 5G: 4/5/6/7. |
| <i>show</i>           | It means to display status or configuration of the selected channel.                                     |
| <i>c</i>              | It means connection time. The unit is minute.                                                            |
| <i>r</i>              | It means reconnection time. The unit is minute.                                                          |

### Example

```
> wl stamgt enable 1
% Station Management Status: enabled
> wl stamgt set 1 60 60
> wl stamgt show 1
NO. SSID          BSSID          Connect time  Reconnect time
1.  Draytek      00:11:22:aa:bb:cc  0d:0:58:26   0d:0:0
```

### Telnet Command: `wl iso_vpn`

This command allows users to activate the function of VPN isolation.

#### Syntax

`wl iso_vpn <ssid> <En>`

#### Syntax Description

| Parameter   | Description                                                                             |
|-------------|-----------------------------------------------------------------------------------------|
| <i>ssid</i> | It means the number of SSID.<br>1: SSID1<br>2: SSID2<br>3: SSID3<br>4: SSID4            |
| <i>En</i>   | It means to enable or disable the function of VPN isolation.<br>0: disable<br>1: enable |

### Example

```
> wl iso_vpn 1 on
% ssid: 1 isolate vpn on :1
```

### Telnet Command: `wl wmm`

This command allows users to set WMM for wireless connection. It defines the priority levels for four access categories derived from 802.1d (prioritization tabs).

#### Syntax

```
wl wmm ap QueIdx Aifsn Cwmin Cwmax Txop ACM
wl wmm bss QueIdx Aifsn Cwmin Cwmax Txop ACM
wl wmm ack Que0_Ack Que1_Ack Que2_Ack Que3_Ack
wl wmm enable SSID0 SSID1 SSID2 SSID3
wl wmm apsd value
wl wmm show
```

## Syntax Description

| Parameter                 | Description                                                                                                                                   |
|---------------------------|-----------------------------------------------------------------------------------------------------------------------------------------------|
| <i>ap</i>                 | It means to set WMM for access point.                                                                                                         |
| <i>bss</i>                | It means to set WMM for wireless clients.                                                                                                     |
| <i>ack</i>                | It means to map to the Ack policy settings of AP WMM.                                                                                         |
| <i>enable</i>             | It means to enable the WMM for each SSID.<br>0: disable<br>1: enable                                                                          |
| <i>apsd &lt;value&gt;</i> | It means to enable / disable the ASPD(automatic power-save delivery) function.<br>0: disable<br>1: enable                                     |
| <i>show</i>               | It displays current status of WMM.                                                                                                            |
| <i>QueIdx</i>             | It means the number of the queue which the WMM settings will be applied to. There are four queues, best effort, background, voice, and video. |
| <i>Aifsn</i>              | It controls how long the client waits for each data transmission.                                                                             |
| <i>Cwmin/ Cwmax</i>       | CWMin means contention Window-Min and CWMax means contention Window-Max. Specify the value ranging from 1 to 15.                              |
| <i>Txop</i>               | It means transmission opportunity. Specify the value ranging from 0 to 65535.                                                                 |
| <i>ACM</i>                | It can restrict stations from using specific category class if it is enabled.<br>0: disable<br>1: enable                                      |

## Example

```

> wl wmm ap 0 3 4 6 0 0
  QueIdx=0: APAifsn=3,APCwmin=4,APCwmax=6, APTxop=0,APACM=0
> wl wmm enable 1 0 1 0
  WMM_SSID0 =1, WMM_SSID1 =0,WMM_SSID2 =1,WMM_SSID3 =0
> wl wmm show
  Enable WMM: SSID0 =1, SSID1 =0,SSID2 =1,SSID3 =0
  APSD=0
  QueIdx=0: APAifsn=3,APCwmin=4,APCwmax=6, APTxop=0,APACM=0
  QueIdx=1: APAifsn=7,APCwmin=4,APCwmax=10, APTxop=0,APACM=0
  QueIdx=2: APAifsn=1,APCwmin=3,APCwmax=4, APTxop=94,APACM=0
  QueIdx=3: APAifsn=1,APCwmin=2,APCwmax=3, APTxop=47,APACM=0
  QueIdx=0: BSSAifsn=3,BSSCwmin=4,BSSCwmax=10, BSSTxop=0,BSSACM=0
  QueIdx=1: BSSAifsn=7,BSSCwmin=4,BSSCwmax=10, BSSTxop=0,BSSACM=0
  QueIdx=2: BSSAifsn=2,BSSCwmin=3,BSSCwmax=4, BSSTxop=94,BSSACM=0
  QueIdx=3: BSSAifsn=2,BSSCwmin=2,BSSCwmax=3, BSSTxop=47,BSSACM=0
  AckPolicy[0]=0: AckPolicy[1]=0,AckPolicy[2]=0,AckPolicy[3]=0

```

## Telnet Command: wl ht

This command allows you to configure wireless settings.

### Syntax

`wl ht bw value`

`wl ht gi value`

wl ht badecline *value*  
 wl ht autoba *value*  
 wl ht rdg *value*  
 wl ht msdu *value*  
 wl ht txpower *value*  
 wl ht antenna *value*  
 wl ht greenfield *value*

### Syntax Description

| Parameter               | Description                                                                         |
|-------------------------|-------------------------------------------------------------------------------------|
| <i>bw value</i>         | The value you can type is 0 (for BW_20) and 1 (for BW_40).                          |
| <i>gi value</i>         | The value you can type is 0 (for GI_800) and 1 (for GI_4001)                        |
| <i>badecline value</i>  | The value you can type is 0 (for disabling) and 1 (for enabling).                   |
| <i>autoba value</i>     | The value you can type is 0 (for disabling) and 1 (for enabling).                   |
| <i>rdg value</i>        | The value you can type is 0 (for disabling) and 1 (for enabling).                   |
| <i>msdu value</i>       | The value you can type is 0 (for disabling) and 1 (for enabling).                   |
| <i>txpower value</i>    | The value you can type ranges from 1 - 6 (level).                                   |
| <i>antenna value</i>    | The value you can type ranges from 0-3.<br>0: 2T3R<br>1: 2T2R<br>2: 1T2R<br>3: 1T1R |
| <i>greenfield value</i> | The value you can type is 0 (for mixed mode) and 1 (for green field).               |

### Example

```

> wl ht bw value 1
  BW=0
  <Note> Please restart wireless after you set new parameters.
> wl restart
  Wireless restart.....
  
```

### Telnet Command: wl restart

This command allows you to restart wireless setting.

### Example

```

> wl restart
  Wireless restart.....
  
```

### Telnet Command: wl wds

This command allows you to configure WDS settings.

### Syntax

wl wds mode [*value*]  
 wl wds security [*value*]  
 wl wds ap [*value*]  
 wl wds hello [*value*]  
 wl wds status

```
wl wds show
wl wds mac [value]
wl wds flush
```

## Syntax Description

| Parameter                                   | Description                                                                                                                                                                                                                                                                                                                                                                                                                                                                                                                                                                                                                                                                           |
|---------------------------------------------|---------------------------------------------------------------------------------------------------------------------------------------------------------------------------------------------------------------------------------------------------------------------------------------------------------------------------------------------------------------------------------------------------------------------------------------------------------------------------------------------------------------------------------------------------------------------------------------------------------------------------------------------------------------------------------------|
| <i>mode [value]</i>                         | It means to specify connection mode for WDS.<br>[value]: Available settings are :<br>d: Disable<br>b: Bridge<br>r: Repeater                                                                                                                                                                                                                                                                                                                                                                                                                                                                                                                                                           |
| <i>security [value]</i>                     | It means to configure security mode with encrypted keys for WDS.<br><i>mode</i> : Available settings are:<br>disable: No security.<br>wep: WEP<br>wpapsk [key]: WPA/PSK<br>wpa2psk [key]: WPA2/PSK<br><i>key</i> : Moreover, you have to add keys for <i>wpapsk</i> , <i>wpa2psk</i> , and <i>wep</i> , and specify index number of schedule profiles to be followed by the wireless connection.<br>WEP keys must be in 5/13 ASCII text string or 10/26 Hexadecimal digit format; WPA keys must be in 8-63 ASCII text string or 64 Hexadecimal digit format.<br>e.g.,<br><pre>wl dual wds security disable wl dual wds security wep 12345 wl dual wds security wpa2psk 12345678</pre> |
| <i>ap [value]</i>                           | It means to enable or disable the AP function.<br>Value: 1 - enable the function.<br>0 - disable the function.                                                                                                                                                                                                                                                                                                                                                                                                                                                                                                                                                                        |
| <i>hello [value]</i>                        | It means to send hello message to remote end (peer).<br>Value: 1 - enable the function.<br>0 - disable the function.                                                                                                                                                                                                                                                                                                                                                                                                                                                                                                                                                                  |
| <i>status</i>                               | It means to display WDS link status for 2.4GHz connection.                                                                                                                                                                                                                                                                                                                                                                                                                                                                                                                                                                                                                            |
| <i>show</i>                                 | It means to display current WDS settings.                                                                                                                                                                                                                                                                                                                                                                                                                                                                                                                                                                                                                                             |
| <i>mac add [index addr]</i>                 | <i>add [index addr]</i> - Add the peer MAC entry in Repeater/Bridge WDS MAC table.                                                                                                                                                                                                                                                                                                                                                                                                                                                                                                                                                                                                    |
| <i>mac clear/disable/enable [index/all]</i> | <i>clear/disable/enable [index/all]</i> - Clear, disable, enable the specified or all MAC entries in Repeater/Bridge WDS MAC table. e.g,<br><pre>wl dual wds mac enable 1</pre>                                                                                                                                                                                                                                                                                                                                                                                                                                                                                                       |
| <i>flush</i>                                | It means to reset all WDS setting.                                                                                                                                                                                                                                                                                                                                                                                                                                                                                                                                                                                                                                                    |

## Example

```
> wl wds status
Please enable WDS hello function first.

> wl wds hello 1
% <Note> Please restart router after you set the parameters.

> wl wds status
```



## Telnet Command: wl apcli

This command allows users to configure AP client mode for wireless connection (2.4GHz).

### Syntax

```
wl apcli show
wl apcli enable <1/0>
wl apcli security <mode>
wl apcli ssid <ssid_name>
wl apcli bssid <mac address>
```

### Syntax Description

| Parameter                        | Description                                                                                                                                                                                                                                                                                                                                                                                                                                                                                                                                                                                                                                                                                                                                                                                                                                                                                                     |
|----------------------------------|-----------------------------------------------------------------------------------------------------------------------------------------------------------------------------------------------------------------------------------------------------------------------------------------------------------------------------------------------------------------------------------------------------------------------------------------------------------------------------------------------------------------------------------------------------------------------------------------------------------------------------------------------------------------------------------------------------------------------------------------------------------------------------------------------------------------------------------------------------------------------------------------------------------------|
| <i>show</i>                      | Display current status of wireless AP client.                                                                                                                                                                                                                                                                                                                                                                                                                                                                                                                                                                                                                                                                                                                                                                                                                                                                   |
| <i>enable &lt;1/0&gt;</i>        | It means to enable wireless 2.4GHz AP client mode.<br>1 - enable<br>0 - disable                                                                                                                                                                                                                                                                                                                                                                                                                                                                                                                                                                                                                                                                                                                                                                                                                                 |
| <i>security &lt;mode&gt;</i>     | There are several modes to be selected:<br>Disable - disable the security settings.<br>wpa2psk [key] - WPA2 Pre-shared Key will be used. Keys must start with 0x to be identified as a Hexadecimal number key. WPA keys must be in 8-63 ASCII string or 64 Hexadecimal digit format.<br>wpa2psk [key] - WPA2 Pre-shared Key will be used. Keys must start with 0x to be identified as a Hexadecimal number key. WPA keys must be in 8-63 ASCII string or 64 Hexadecimal digit format.<br>wpamixpsk [key] - WPA Mixed Pre-shared Key will be used. Keys must start with 0x to be identified as a Hexadecimal number key. WPA keys must be in 8-63 ASCII string or 64 Hexadecimal digit format.<br>wep [key] [index] - WEP key will be used. You need to Enter the key string and specify the index number of the profile to be applied. WEP keys must be in 5/13 ASCII string or 10/26 Hexadecimal digit format. |
| <i>ssid &lt;ssid_name&gt;</i>    | Specify the SSID for wireless 2.4GHz AP client.                                                                                                                                                                                                                                                                                                                                                                                                                                                                                                                                                                                                                                                                                                                                                                                                                                                                 |
| <i>bssid &lt;mac address&gt;</i> | Enter the MAC address for wireless 2.4GHz AP client.                                                                                                                                                                                                                                                                                                                                                                                                                                                                                                                                                                                                                                                                                                                                                                                                                                                            |

### Example

```
> wl apcli enable 1
Wireless AP-Client is enabled
> wl apcli show
% Wireless AP-Client is enabled
% Current SSID is test
%% Security Mode: disable
% Wireless client is disconnected
%% data rate=---, mode=---, signal=0%
```

## Telnet Command: wl btncctl

This command allows you to enable or disable wireless button control.

### Syntax

```
wl btncctl <value>
```

## Syntax Description

| Parameter    | Description             |
|--------------|-------------------------|
| <i>value</i> | 0: disable<br>1: enable |

## Example

```
> wl btnctl 1
Enable wireless botton control
Current wireless botton control is on
>
```

## Telnet Command: wl iwpriv

This command is reserved for RD debug. Do not use them.

## Telnet Command: wl ce\_cert

For sharing the wireless network, the WiFi clients can be authenticated by Vigor router with specific certificate.

## Syntax

`wl ce_cert <on/off>[<command><parameter>|...]`

`wl ce_cert performance`

`wl ce_cert R61 <value>`

`wl ce_cert R61 show`

## Syntax Description

| Parameter                                     | Description                                                                                                                                                                                                                                                                                                                             |
|-----------------------------------------------|-----------------------------------------------------------------------------------------------------------------------------------------------------------------------------------------------------------------------------------------------------------------------------------------------------------------------------------------|
| <i>&lt;on/off&gt;</i>                         | Enable or disable the certificate.<br>on - Enable.<br>off - Disable.                                                                                                                                                                                                                                                                    |
| <i>[&lt;command&gt;&lt;parameter&gt; ...]</i> | The available commands with parameters are listed below.<br>[...] means that you can Enter several commands in one line.<br>There are ten parameters;<br>TxBurst<br>HT_RDG<br>HT_AutoBA<br>HT_BADecline<br>EDCCA_AP_STA_TH<br>EDCCA_AP_AP_TH<br>EDCCA_FALSE_CCA_TH<br>EDCCA_ED_TH <value> -<br>EDCCA_BLOCK_CHECK_TH<br>EDCCA_AP_RSSI_TH |
| <i>TxBurst &lt;0/1&gt;</i>                    | Enable or disable the TxBurst feature.<br>1 - Enable; 0 - Disable                                                                                                                                                                                                                                                                       |
| <i>HT_RDG &lt;0/1&gt;</i>                     | Enable or disable the HT_RDG feature.<br>1 - Enable; 0 - Disable                                                                                                                                                                                                                                                                        |

|                                     |                                                                                          |
|-------------------------------------|------------------------------------------------------------------------------------------|
| <i>HT_AutoBA</i> <0/1>              | Enable or disable the HT_AutoBA feature.<br>1 - Enable; 0 - Disable                      |
| <i>HT_BADecline</i> <0/1>           | Enable or disable the HT_BADecline feature.<br>1 - Enable; 0 - Disable                   |
| <i>EDCCA_AP_STA_TH</i> <value>      | Set a number for EDCCA_AP_STA_TH.<br><value> - Ranges from 1 to 255.                     |
| <i>EDCCA_AP_AP_TH</i> <value>       | Set a number for EDCCA_AP_AP_TH.<br><value> - Ranges from 1 to 255.                      |
| <i>EDCCA_FALSE_CCA_TH</i> <value>   | Set a number for EDCCA_FALSE_CCA_TH.<br><value> - Any number greater than 0 (integer).   |
| <i>EDCCA_ED_TH</i> <value>          | Set a number for EDCCA_ED_TH.<br><value> - Ranges from 1 to 255.                         |
| <i>EDCCA_BLOCK_CHECK_TH</i> <value> | Set a number for EDCCA_BLOCK_CHECK_TH.<br><value> - Any number greater than 0 (integer). |
| <i>EDCCA_AP_RSSI_TH</i> <value>     | Set a number for EDCCA_AP_RSSI_TH.<br><value> - Ranges from 0 to 25.                     |
| <i>performance</i>                  | Show the parameters with the values for getting the best performance.                    |
| <i>R61</i> <value>                  | Set a number for BBP_R61.<br><value> - Ranges from 1 to 10.                              |
| <i>R61 show</i>                     | Display R61 setting status.                                                              |

## Example

```

> wl ce_cert on 0 1 1 0 255 255 3000 90 8 -80
<Note> Please restart wireless after you set new parameters.

ED_CERT is enabled
TxBurst          :0 (default :0)
HT_RDG           :1 (default :0)
HT_AUTO_BA      :1 (default :1)
HT_BA_DECLINE   :0 (default :0)
EDCCA_AP_STA_TH :255
EDCCA_AP_AP_TH  :255
EDCCA_FALSE_CCA_TH :3000
EDCCA_ED_TH     :90
EDCCA_BLOCK_CHECK_TH :8
EDCCA_AP_RSSI_TH :-80
> wl ce_cert performance
Parameters for best performance :
ED_CERT is enabled
TxBurst          :0
HT_RDG           :1
HT_AUTO_BA      :1
HT_BA_DECLINE   :0
EDCCA_AP_STA_TH :20
EDCCA_AP_AP_TH  :20
EDCCA_FALSE_CCA_TH :180
EDCCA_ED_TH     :90
EDCCA_BLOCK_CHECK_TH:2
EDCCA_AP_RSSI_TH :-80
<Note> Please restart wireless.
>

```

## Telnet Command: wl stalist

This command is used to display the wireless station which accessing Internet via Vigor router.

### Syntax

wl stalist

### Example

```
> wl stalist
wl stalist show      : show station list
wl stalist num       : show number of stations
wl stalist neighbor  : show neighbor station list
```

## Telnet Command: wl set8021x

This command allows you to configure the external or internal server used by Vigor router for wireless authentication.

### Syntax

wl set8021x -t <0/1>

wl set8021x -v

### Syntax Description

| Parameter | Description                                                                                                                                                    |
|-----------|----------------------------------------------------------------------------------------------------------------------------------------------------------------|
| -t        | Specify the type (external or internal) of wireless authentication server.<br>0 - Indicate the external RADIUS server.<br>1- Indicate the local 802.1x server. |
| -v        | View the settings of 802.1x.                                                                                                                                   |

### Example

```
> wl set8021x -t 1
% <Note> Please restart wireless after you set the parameters.
> wl set8021x -v
802.1X type is : Local 802.1X
>
```

## Telnet Command: wl bndstrg

This command allows users to configure settings for Band Steering (2.4GHz).

### Syntax

wl bndstrg show

wl bndstrg enable <1/0>

wl bndstrg chk\_time <value>

### Syntax Description

| Parameter   | Description                                                      |
|-------------|------------------------------------------------------------------|
| show        | Display current status for Band Steering function.               |
| enable<1/0> | It means to enable wireless 2.4GHz AP client mode.<br>1 - enable |

|                         |                                                                                                                                                                                                                                                                                                           |
|-------------------------|-----------------------------------------------------------------------------------------------------------------------------------------------------------------------------------------------------------------------------------------------------------------------------------------------------------|
|                         | 0 - disable                                                                                                                                                                                                                                                                                               |
| <i>chk_time</i> <value> | If the wireless station does not have the capability of 5GHz network connection, the system shall wait and check for several seconds (15 seconds, in default) to make the 2.4GHz network connection. Specify the time limit for Vigor router to detect the wireless client.<br>[value] - 1 to 60 seconds. |

### Example

```
> wl bndstrg show
band steering: disable
chk_time: 15 sec
> wl bndstrg chk_time 50 30
argv[0]:chk_time, argv[1]:50, argv[2]:30

%% Wireless card must be reset for configurations to take effect
%% (Telnet Command: wl restart)
```

## Telnet Command: wl artfns

This command allows users to configure airtime fairness function for wireless (2.4GHz) connection.

### Syntax

```
wl artfns enable <value>
wl artfns trg_num <value>
wl artfns show
```

### Syntax Description

| Parameter              | Description                                                                                                                                              |
|------------------------|----------------------------------------------------------------------------------------------------------------------------------------------------------|
| <i>enable</i> <value>  | It means to enable wireless airtime fairness function.<br>1 - enable<br>0 - disable                                                                      |
| <i>trg_num</i> <value> | Set a threshold when the active station number achieves this number, the airtime fairness function will be applied.<br>Available values will be 2 to 64. |
| <i>show</i>            | Display current status (enable or disable) and triggering client number for airtime fairness function.                                                   |

### Example

```
> wl artfns enable 1
> wl artfns trg_num 3
> wl artfns show
airtime fairness: enable
trg_num: 3
>
```

## Telnet Command: wl drayrs

This command allows the user to configure settings for Roaming for wireless clients.

### Syntax

```
wl drayrs set <mode><rs_low><rs_low_security><delta>
wl drayrs restart
```

wl drayrs show

## Syntax Description

| Parameter                                              | Description                                                                                                                                                                                                                                                       |
|--------------------------------------------------------|-------------------------------------------------------------------------------------------------------------------------------------------------------------------------------------------------------------------------------------------------------------------|
| <i>set</i> <mode> <rs_low><br><rs_low_security><delta> | Select a mode for roaming.<br>0 - disable<br>1 - Strictly Minimum RSSI<br>2 - Minimum RSSI<br>rs_low - Set a value of Strictly Minimum RSSI (62-86).<br>rs_low_security - Set a value of Minimum RSSI (62-86).<br>delta - Set a value of Adjacent AP RSSI (1-20). |
| <i>restart</i>                                         | Restart to activate roaming function.                                                                                                                                                                                                                             |
| <i>show</i>                                            | Display current configuration of roaming function.                                                                                                                                                                                                                |

## Example

```
> wl drayrs show
% Mode : Disable
% rs_low      : -73
% rs_low_secure : -66
% delta      : 5
>
```

## Telnet Command: wl\_dual acl

This command allows the user to configure wireless (5GHz) access control settings.

### Syntax

```
wl_dual acl enable <ssid1 ssid2 ssid3 ssid4>
wl_dual acl disable <ssid1 ssid2 ssid3 ssid4>
wl_dual acl add <MAC><ssid1 ssid2 ssid3 ssid4> <comment> isolate
wl_dual acl del <MAC>
wl_dual acl mode <ssid1 ssid2 ssid3 ssid4> <white/black>
wl_dual acl show
wl_dual acl showmode
wl_dual acl clear
```

### Syntax Description

| Parameter                                          | Description                                                                                                                                                                                                                                                                               |
|----------------------------------------------------|-------------------------------------------------------------------------------------------------------------------------------------------------------------------------------------------------------------------------------------------------------------------------------------------|
| <i>enable</i> <ssid1 ssid2 ssid3 ssid4>            | It means to enable the settings for SSID1, SSID2, SSID3 and SSID4.                                                                                                                                                                                                                        |
| <i>disable</i> <ssid1 ssid2 ssid3 ssid4>           | It means to disable the settings for SSID1, SSID2, SSID3 and SSID4.                                                                                                                                                                                                                       |
| <i>add</i> <MAC><ssid1 ssid2 ssid3 ssid4><comment> | It means to associate a MAC address to certain SSID interfaces' access control settings. The isolate setting will limit the wireless client's network capabilities to accessing the wireless LAN only.<br>[MAC] format: xx-xx-xx-xx-xx-xx<br>or xx:xx:xx:xx:xx:xx<br>or xx.xx.xx.xx.xx.xx |
| <i>isolate</i>                                     | It means to isolate the wireless connection of the wireless client (identified with the MAC address) from LAN.                                                                                                                                                                            |
| <i>del</i> <MAC>                                   | It means to delete a MAC address entry defined in the access                                                                                                                                                                                                                              |

|                                                     |                                                                                                  |
|-----------------------------------------------------|--------------------------------------------------------------------------------------------------|
|                                                     | control list.<br>[MAC] format: xx-xx-xx-xx-xx-xx<br>or xx:xx:xx:xx:xx:xx<br>or xx.xx.xx.xx.xx.xx |
| <i>mode</i> <ssid1 ssid2 ssid3 ssid4> <white/black> | It means to set white/black list for each SSID.                                                  |
| <i>show</i>                                         | It means to display current status of access control.                                            |
| <i>showmode</i>                                     | It means to show the mode for each SSID.                                                         |
| <i>clear</i>                                        | It means to clear all of the access control settings.                                            |

## Example

```

> wl_dual acl showmode
SSID1: None
SSID2: None
SSID3: None
SSID4: None
> wl_dual acl add 14-49-BC-0D-8F-00 ssid1 ssid2 tet111 isolate
Set Done !!
> wl_dual acl show
----- Mac Address Filter Status -----
SSID1: Disable SSID2: Disable SSID3: Disable SSID4: Disable
----- MAC Address List -----
Index   Attribute   MAC Address       Associated SSIDs   Comment
  1      s          14:49:bc:0d:8f:00  SSID1 SSID2      tet111
s: Isolate the station from LAN

```

## Telnet Command: wl\_dual apscan

This command is used to scan Access Point installed near the location of Vigor router.

### Syntax

*wl\_dual apscan start*

*wl\_dual apscan show*

### Syntax Description

| Parameter    | Description                                     |
|--------------|-------------------------------------------------|
| <i>start</i> | It means to execute the AP scanning.            |
| <i>show</i>  | It means to display the content of the AP list. |

## Example

```

> wl_dual apscan start
> wl_dual apscan show
AP scan is ongoing.
> wl_dual apscan ?
% wl_dual apscan [start/show]
% start: do AP scan
% show: show AP list

> wl_dual apscan show
5G Access Point List :

```

|       |         |      |
|-------|---------|------|
| BSSID | Channel | SSID |
|-------|---------|------|

## Telnet Command: wl\_dual config

This command allows users to configure general settings and security settings for wireless connection (5GHz).

```

wl_dual config enable <value>
wl_dual config enable show
wl_dual config mode <value>
wl_dual config mode show
wl_dual config channel <number>
wl_dual config channel show
wl_dual config preamble <enable>
wl_dual config preamble show
wl_dual config bw <value>
wl_dual config ssid <ssid_num enable ssid_name>
wl_dual config ssid hide <ssid_num enable>
wl_dual config ssid show
wl_dual config ratectl <ssid_num enable upload download>
wl_dual config ratectl show
wl_dual config isolate lan <ssid_num enable>
wl_dual config isolate member <ssid_num enable>
wl_dual config isolate vpn <ssid_num enable>
wl_dual config isolate show
wl_dual config frag <value>
wl_dual config frag show
wl_dual config rts <value>
wl_dual config rts show
wl_dual config rate_alg <value>
wl_dual config country <value>
wl_dual config txpower <value>
wl_dual config nss <value>

```

### Syntax Description

| Parameter               | Description                                                                                                                                                                                                                                                                    |
|-------------------------|--------------------------------------------------------------------------------------------------------------------------------------------------------------------------------------------------------------------------------------------------------------------------------|
| <i>enable</i> <value>   | It means to enable/disable the 5GHz wireless function.<br>1: enable<br>0: disable                                                                                                                                                                                              |
| <i>show</i>             | It means to display if 5G wireless function is enabled or not.                                                                                                                                                                                                                 |
| <i>mode</i> <value>     | It means to select connection mode for wireless connection.<br>Available settings are: "11a", "11n_5g", "11n" and "11an".                                                                                                                                                      |
| <i>mode show</i>        | It means to display what the current wireless mode is.                                                                                                                                                                                                                         |
| <i>channel</i> <number> | It means the channel of frequency of the wireless LAN.<br>The available settings are: 36, 40, 44, 48, 52, 56, 60, 64, 100, 104, 108, 112, 116, 120, 124, 128, 132, 136 and 140.<br>number=0, means Auto<br>number=36, means Channel 36<br>....<br>Number=52, means Channel 52. |



|                                                        |                                                                                                                                                                                                                                                                                                                                                                                                                                                                                                                         |
|--------------------------------------------------------|-------------------------------------------------------------------------------------------------------------------------------------------------------------------------------------------------------------------------------------------------------------------------------------------------------------------------------------------------------------------------------------------------------------------------------------------------------------------------------------------------------------------------|
| <i>channel show</i>                                    | It means to display what the current channel is.                                                                                                                                                                                                                                                                                                                                                                                                                                                                        |
| <i>preamble &lt;enable&gt;</i>                         | It means to define the length of the sync field in an 802.11 packet. Most modern wireless network uses short preamble with 56 bit sync field instead of long preamble with 128 bit sync field. However, some original 11b wireless network devices only support long preamble.<br>0: disable to use long preamble.<br>1: enable to use long preamble.                                                                                                                                                                   |
| <i>preamble show</i>                                   | It means to display if preamble is enabled or not.                                                                                                                                                                                                                                                                                                                                                                                                                                                                      |
| <i>bw &lt;value&gt;</i>                                | It means to select the channel bandwidth for WLAN for data transmission and reception between the router and wireless stations.<br>value - 0, 1, 2<br>0 means BW_20, 1 means BW_20_40; 2 means BW20_40_80.                                                                                                                                                                                                                                                                                                              |
| <i>ssid &lt;ssid_num enable ssid_name&gt;</i>          | It means to set the name of the SSID, hide the SSID if required.<br><i>ssid_num</i> : Type 1, 2, 3 or 4 to specify SSID1, SSID2, SSID3 or SSID4.<br><i>ssid_name</i> : Give a name for the specified SSID.                                                                                                                                                                                                                                                                                                              |
| <i>ssid hide &lt;ssid_num enable&gt;</i>               | It means to hide the name of the SSID if required.<br><i>ssid_num</i> : Type 1, 2, 3 or 4 to specify SSID1, SSID2, SSID3 or SSID4.<br>enable: Type 0 to hide the SSID or 1 to display the SSID.                                                                                                                                                                                                                                                                                                                         |
| <i>ssid show</i>                                       | It means to display a table of SSID configuration.                                                                                                                                                                                                                                                                                                                                                                                                                                                                      |
| <i>ratectl &lt;ssid_num enable upload download&gt;</i> | It means to set the rate control for the specified SSID.<br><i>ssid_num</i> : Choose 1, 2, 3 or 4 to specify SSID1, SSID2, SSID3 or SSID4.<br><i>enable</i> : It means to enable the function of the rate control for the specified SSID. 0: disable and 1:enable.<br><i>upload</i> : It means to configure the rate control for data upload. The unit is kbps.<br><i>download</i> : It means to configure the rate control for data download. The unit is kbps.<br>(example: <i>wl dual config ratectl 1 1 25 25</i> ) |
| <i>ratectl show</i>                                    | It means to display the data transmission rate (upload and download) for SSID1, SSID2, SSID3 and SSID4.                                                                                                                                                                                                                                                                                                                                                                                                                 |
| <i>isolate lan &lt;ssid_num enable&gt;</i>             | It means to isolate the wireless connection from LAN. It can make the wireless clients (stations) with remote-dial and LAN to LAN users not accessing for each other.<br><i>ssid_num</i> : Choose 1, 2, 3 or 4 to specify SSID1, SSID2, SSID3 or SSID4.<br><i>enable</i> : It means to enable such function.<br>0: disable and 1:enable                                                                                                                                                                                 |
| <i>isolate member &lt;ssid_num enable&gt;</i>          | It means to isolate the wireless connection from Member. It can make the wireless clients (stations) with the same SSID not accessing for each other.<br><i>ssid_num</i> : Choose 1, 2, 3 or 4 to specify SSID1, SSID2, SSID3 or SSID4.<br><i>enable</i> : It means to enable such function.<br>0: disable and 1:enable.                                                                                                                                                                                                |
| <i>isolate vpn &lt;ssid_num enable&gt;</i>             | It means to isolate the wireless connection from VPN.<br><i>ssid_num</i> : Choose 1, 2, 3 or 4 to specify SSID1, SSID2, SSID3 or SSID4.<br><i>enable</i> : It means to enable such function.<br>0: disable and 1:enable.                                                                                                                                                                                                                                                                                                |
| <i>isolate show</i>                                    | It means to display the status of wireless isolation.                                                                                                                                                                                                                                                                                                                                                                                                                                                                   |
| <i>frag &lt;value&gt;</i>                              | It means to set the fragment threshold.<br>value: Enter a number (256 to 2346).                                                                                                                                                                                                                                                                                                                                                                                                                                         |
| <i>frag show</i>                                       | It means to display current value of fragment threshold.                                                                                                                                                                                                                                                                                                                                                                                                                                                                |
| <i>rts &lt;value&gt;</i>                               | It means to set the RTS threshold.                                                                                                                                                                                                                                                                                                                                                                                                                                                                                      |

|                               |                                                                                                                                                             |
|-------------------------------|-------------------------------------------------------------------------------------------------------------------------------------------------------------|
|                               | value: Enter a number (1 to 2347).                                                                                                                          |
| <i>rts show</i>               | It means to display current value of RTS threshold.                                                                                                         |
| <i>rate_alg &lt;value&gt;</i> | It means to select the wireless transmission rate. Usually, performance of “new” algorithm is better than “old”.<br>0 - old algorithm,<br>1 - new algorithm |
| <i>country &lt;value&gt;</i>  | It means to set the country code. Each country will be represented with two digits.<br>value: Enter two capital letters (e.g., TW, UK, CN..)                |
| <i>txpower &lt;value&gt;</i>  | It means to set TX power.<br>Value: Enter a number (1 to 6).                                                                                                |
| <i>nss &lt;value&gt;</i>      | It means to set NSS.<br>Value: Enter a number (0 to 4).                                                                                                     |

### Example

```

> wl_dual config mode 11a
Current mode is 11a
% <Note> Please restart 5G wireless after you set the channel
> wl_dual config channel 60
Current channel is 60
% <Note> Please restart 5G wireless after you set the channel.
> wl_dual config preamble 1
Long preamble is enabled
% <Note> Please restart 5G wireless after you set the parameters.
> wl_dual config ssid 1 enable dray
SSID Enable Hide_SSID Name
1 1 0 dray
% <Note> Please restart 5G wireless after you set the parameters.
> wl_dual config ssid show
SSID Enable Hide_SSID Name
1 1 0 dray
2 0 0 DrayTek_5G_Guest
3 0 0
4 0 0

```

### Telnet Command: **wl\_dual restart**

This command allows you to restart wireless setting (5GHz).

### Example

```

> wl_dual restart
5G wireless restart.....

```

### Telnet Command: **wl\_dual security**

This command allows users to configure security settings for the wireless connection (5GHz).

### Syntax

wl\_dual security <SSID\_NUMBER><mode><key><index>

wl\_dual security show

### Syntax Description

| Parameter | Description |
|-----------|-------------|
|-----------|-------------|

|                                                                                |                                                                                                                                                                                                                                                                                                                                                                                                                                                                                                                                                                                                                                                                                                                                                                                                                                                                           |
|--------------------------------------------------------------------------------|---------------------------------------------------------------------------------------------------------------------------------------------------------------------------------------------------------------------------------------------------------------------------------------------------------------------------------------------------------------------------------------------------------------------------------------------------------------------------------------------------------------------------------------------------------------------------------------------------------------------------------------------------------------------------------------------------------------------------------------------------------------------------------------------------------------------------------------------------------------------------|
| <pre>security &lt;SSID_NUMBER&gt; &lt;mode&gt; &lt;key&gt; &lt;index&gt;</pre> | <p><i>SSID_NUMBER</i>: Type 1, 2, 3 or 4 to specify SSID1, SSID2, SSID3 or SSID4.</p> <p><i>mode</i>: Available settings are:</p> <p>disable: No security.</p> <p>wpa1x: WPA/802.1x Only</p> <p>wpa21x: WPA2/802.1x Only</p> <p>wpamix1x: Mixed (WPA+WPA2/802.1x only)</p> <p>wep1x: WEP/802.1x Only</p> <p>wpa2psk: WPA/PSK</p> <p>wpa2psk: WPA2/PSK</p> <p>wpamixpsk: Mixed (WPA+WPA2)/PSK</p> <p>wpa3sae: WPA3/SAE</p> <p>wpa3mixsae: Mixed (WPA2+WPA3)/SAE</p> <p>wep: WEP</p> <p><i>key, index</i>: Moreover, you have to add keys for <i>wpa2psk</i>, <i>wpa2psk</i>, <i>wpamixpsk</i> and <i>wep</i>, and specify index number of schedule profiles to be followed by the wireless connection.</p> <p>WEP keys must be in 5/13 ASCII text string or 10/26 Hexadecimal digit format; WPA keys must be in 8-63 ASCII text string or 64 Hexadecimal digit format.</p> |
| <pre>show</pre>                                                                | <p>It means to display current mode selection for each SSID.</p>                                                                                                                                                                                                                                                                                                                                                                                                                                                                                                                                                                                                                                                                                                                                                                                                          |

## Example

```
> wl_dual security 1 wpa2psk 123456789e
% <Note> Please restart 5G wireless after you set the parameters.

> wl_dual security show
%% 5G Wireless LAN Security Settings:
% SSID1
%% Mode: WPA2/PSK
% SSID2
%% Mode: Disable
% SSID3
%% Mode: Disable
% SSID4
%% Mode: Disable
```

## Telnet Command: wl\_dual stalist

This command is used to display the wireless station which accessing Internet via Vigor router.

### Syntax

```
wl_dual stalist show
wl_dual stalist num
wl_dual stalist neighbor
wl_dual stalist validtime <time>
wl_dual stalist maxmum <num>
```

### Syntax Description

| Parameter               | Description                                      |
|-------------------------|--------------------------------------------------|
| <i>validtime</i> <time> | Set the valid time of the neighbor station list. |

|                     |                                                                         |
|---------------------|-------------------------------------------------------------------------|
|                     | <time> - 0 to 300000.                                                   |
| <i>Maxnum</i> <num> | Set the maximum number of neighbor station list.<br><value> - 10 to 512 |

## Example

```

> wl_dual stalist neighbor
5G Wireless Neighbor Station List :
MAC Address      |Vendor Name      |RSSI(%)|RSSI(dbm)|SSID|time(ms)
F2:C6:DB:2B:25:E0|                 |24     |-84     |none|20
D6:FC:CB:DC:C1:E8|                 |24     |-84     |none|0
80:00:0B:04:CE:5A|Intel           |11     |-88     |none|7230880
00:1D:AA:80:FE:D6|DrayTek         |15     |-87     |none|7210610
A6:99:E2:27:7F:A0|                 |50     |-76     |none|20
0A:32:AB:06:88:2C|                 |40     |-79     |none|0
F8:63:3F:56:06:C6|                 |15     |-87     |none|881950
1E:B9:C9:03:04:52|                 |87     |-62     |none|20
8E:DF:E3:0A:F4:02|                 |3      |-92     |none|20
E2:41:8F:4B:1A:11|                 |50     |-76     |none|20
BA:96:81:7D:11:BD|                 |24     |-84     |none|10
7C:2A:31:10:1B:11|                 |2      |-93     |none|0

```

## Telnet Command: wl\_dual wds

This command allows users to configure WDS for wireless connection (5GHz).

### Syntax

```

wl_dual wds mode <value>
wl_dual wds security <value>
wl_dual wds ap <value>
wl_dual wds hello <value>
wl_dual wds status
wl_dual wds show
wl_dual wds mac add <index addr>
wl_dual wds mac clear/disable/enable <index/all>
wl_dual wds flush

```

### Syntax Description

| Parameter               | Description                                                                                                                                                                                                                                                                                             |
|-------------------------|---------------------------------------------------------------------------------------------------------------------------------------------------------------------------------------------------------------------------------------------------------------------------------------------------------|
| <i>mode</i> <value>     | It means to specify connection mode for WDS.<br>[value]: Available settings are :<br>d: Disable<br>b: Bridge<br>r: Repeater                                                                                                                                                                             |
| <i>security</i> <value> | It means to configure security mode with encrypted keys for WDS.<br><i>mode</i> : Available settings are:<br>disable: No security.<br>wep: WEP<br>wpapsk [key]: WPA/PSK<br>wpa2psk [key]: WPA2/PSK<br><i>key</i> : Moreover, you have to add keys for <i>wpapsk</i> , <i>wpa2psk</i> , and <i>wep</i> , |

|                                                   |                                                                                                                                                                                                                                                                                                                                                                                           |
|---------------------------------------------------|-------------------------------------------------------------------------------------------------------------------------------------------------------------------------------------------------------------------------------------------------------------------------------------------------------------------------------------------------------------------------------------------|
|                                                   | <p>and specify index number of schedule profiles to be followed by the wireless connection.</p> <p>WEP keys must be in 5/13 ASCII text string or 10/26 Hexadecimal digit format; WPA keys must be in 8-63 ASCII text string or 64 Hexadecimal digit format.</p> <p>e.g.,</p> <pre>wl_dual wds security disable wl_dual wds security wep 12345 wl_dual wds security wpa2psk 12345678</pre> |
| <i>ap &lt;value&gt;</i>                           | <p>It means to enable or disable the AP function.</p> <p>Value: 1 - enable the function.<br/>0 - disable the function.</p>                                                                                                                                                                                                                                                                |
| <i>hello &lt;value&gt;</i>                        | <p>It means to send hello message to remote end (peer).</p> <p>Value: 1 - enable the function.<br/>0 - disable the function.</p>                                                                                                                                                                                                                                                          |
| <i>status</i>                                     | <p>It means to display WDS link status for 5GHz connection.</p>                                                                                                                                                                                                                                                                                                                           |
| <i>show</i>                                       | <p>It means to display current WDS settings.</p>                                                                                                                                                                                                                                                                                                                                          |
| <i>mac add &lt;index addr&gt;</i>                 | <p><i>add [index addr]</i> - Add the peer MAC entry in Repeater/Bridge WDS MAC table.</p>                                                                                                                                                                                                                                                                                                 |
| <i>mac clear/disable/enable &lt;index/all&gt;</i> | <p><i>clear/disable/enable [index/all]</i>- Clear, disable, enable the specified or all MAC entries in Repeater/Bridge WDS MAC table. e.g,</p> <pre>wl_dual wds mac enable 1</pre>                                                                                                                                                                                                        |
| <i>flush</i>                                      | <p>It means to reset all WDS setting.</p>                                                                                                                                                                                                                                                                                                                                                 |

## Example

```
> wl_dual wds status
Please enable WDS hello function first.

> wl_dual wds hello 1
% <Note> Please restart router after you set the parameters.
> wl dual wds mode b
> wl dual wds security wep
> wl_dual wds show
5G Wireless WDS Setting

Mode : Bridge
Security : WEP
AP Function : Enable
Send Hello Function : Enable

Bridge :
Index  Enable  MAC Address
  1      0      00:00:00:00:00:00
  2      0      00:00:00:00:00:00
  3      0      00:00:00:00:00:00
  4      0      00:00:00:00:00:00

Repeater :
Index  Enable  MAC Address
  5      0      00:00:00:00:00:00
  6      0      00:00:00:00:00:00
  7      0      00:00:00:00:00:00
  8      0      00:00:00:00:00:00
> wl_dual wds wep 12345
```

% <Note> Please restart router after you set the parameters.

## Telnet Command: wl\_dual wps

This command allows users to configure WPS for wireless connection (5GHz).

### Syntax

```
wl_dual wps enable <value>
wl_dual wps pbc
wl_dual wps pin <code>
wl_dual wps show
```

### Syntax Description

| Parameter             | Description                                                                                |
|-----------------------|--------------------------------------------------------------------------------------------|
| <i>enable</i> <value> | It means to enable WPS.<br>1 - enable<br>0 - disable                                       |
| <i>pbc</i>            | It means to start WPS by pressing the WLAN ON/OFF WPS button on Vigor router.              |
| <i>pin</i> <code>     | It means to start WPS by using client PIN code.<br>[code]: Client PIN code (digit number). |
| <i>show</i>           | It means to display current WPS settings.                                                  |

### Example

```
> wl_dual wps enable 1
WPS is enabled.
> wl_dual wps pin 88563337
WPS has triggered by PIN code.
The AP will wait for WPS request from your client for 2 minutes...
```

## Telnet Command: wl\_dual set8021x

This command allows you to configure the external or internal server used by Vigor router for wireless authentication (5GHz).

### Syntax

```
wl_dual set8021x -t <0/1>
wl_dual set8021x -v
```

### Syntax Description

| Parameter | Description                                                                                                                                                     |
|-----------|-----------------------------------------------------------------------------------------------------------------------------------------------------------------|
| <i>-t</i> | Specify the type (external or internal) of wireless authentication server.<br>0 - Indicate the external RADIUS server.<br>1 - Indicate the local 802.1x server. |
| <i>-v</i> | View the settings of 802.1x.                                                                                                                                    |

### Example

```
> wl_dual set8021x -t 1
% <Note> Please restart 5G wireless after you set the parameters.
> wl_dual set8021x -v
802.1X type is : Local 802.1X
```

```
>
```

## Telnet Command: `wl_dual apcli`

This command allows users to configure AP client mode for wireless connection (5GHz).

### Syntax

```
wl_dual apcli show
wl_dual apcli enable <value>
wl_dual apcli security <mode>
wl_dual apcli ssid <ssid_name>
wl_dual apcli bssid <MAC address>
```

### Syntax Description

| Parameter                              | Description                                                                                                                                                                                                                                                                                                                                                                                                                                                                                                                                                                                                                                                                                                                                                                                                                                                                                                  |
|----------------------------------------|--------------------------------------------------------------------------------------------------------------------------------------------------------------------------------------------------------------------------------------------------------------------------------------------------------------------------------------------------------------------------------------------------------------------------------------------------------------------------------------------------------------------------------------------------------------------------------------------------------------------------------------------------------------------------------------------------------------------------------------------------------------------------------------------------------------------------------------------------------------------------------------------------------------|
| <code>show</code>                      | Display current status of wireless AP client.                                                                                                                                                                                                                                                                                                                                                                                                                                                                                                                                                                                                                                                                                                                                                                                                                                                                |
| <code>enable &lt;value&gt;</code>      | It means to enable wireless 5GHz AP client mode.<br>1 - enable<br>0 - disable                                                                                                                                                                                                                                                                                                                                                                                                                                                                                                                                                                                                                                                                                                                                                                                                                                |
| <code>security &lt;mode&gt;</code>     | There are several modes to be selected:<br>Disable - disable the security settings.<br>wpa2psk [key] - WPA Pre-shared Key will be used. Keys must start with 0x to be identified as a Hexadecimal number key. WPA keys must be in 8-63 ASCII string or 64 Hexadecimal digit format.<br>wpa2psk [key] - WPA2 Pre-shared Key will be used. Keys must start with 0x to be identified as a Hexadecimal number key. WPA keys must be in 8-63 ASCII string or 64 Hexadecimal digit format.<br>wpa2psk [key] - WPA Mixed Pre-shared Key will be used. Keys must start with 0x to be identified as a Hexadecimal number key. WPA keys must be in 8-63 ASCII string or 64 Hexadecimal digit format.<br>wep [key] [index] - WEP key will be used. You need to Enter the key string and specify the index number of the profile to be applied. WEP keys must be in 5/13 ASCII string or 10/26 Hexadecimal digit format. |
| <code>ssid &lt;ssid_name&gt;</code>    | Specify the SSID for wireless 5GHz AP client.                                                                                                                                                                                                                                                                                                                                                                                                                                                                                                                                                                                                                                                                                                                                                                                                                                                                |
| <code>bssid &lt;MAC address&gt;</code> | Enter the MAC address for wireless 5GHz AP client.                                                                                                                                                                                                                                                                                                                                                                                                                                                                                                                                                                                                                                                                                                                                                                                                                                                           |

### Example

```
> wl_dual apcli enable 1
Wireless 5G AP-Client is enabled
Vigor> wl_dual apcli show
% Wireless 5G AP-Client is enabled
% Current SSID is
%% Security Mode: disable
% Wireless 5G client is disconnected
%% data rate=---, mode=---, signal=0%
> wl_dual apcli ssid carrie
% <Note> Please restart wireless 5g after you set the parameters.
Current SSID is carrie
```

## Telnet Command: `wl_dual artfns`

This command allows users to configure airtime fairness function for wireless (5GHz) connection.

## Syntax

```
wl_dual artfns enable <value>
wl_dual artfns trg_num <value>
wl_dual artfns show
wl_dual artfns status
```

## Syntax Description

| Parameter              | Description                                                                                                                                              |
|------------------------|----------------------------------------------------------------------------------------------------------------------------------------------------------|
| <i>enable</i> <value>  | It means to enable wireless airtime fairness function.<br>1 - enable<br>0 - disable                                                                      |
| <i>trg_num</i> <value> | Set a threshold when the active station number achieves this number, the airtime fairness function will be applied.<br>Available values will be 2 to 64. |
| <i>show</i>            | Display current status (enable or disable) and triggering client number for airtime fairness function.                                                   |
| <i>status</i>          | Display whether the function of airtime fairness is enabled or disabled.                                                                                 |

## Example

```
> wl_dual artfns show
airtime fairness for 5G: disable
trg_num: 2
> wl_dual artfns status
airtime fairness for 5G is disabled !!!

> wl_dual artfns enable 0
> wl_dual artfns trg_num 2
> wl_dual artfns show
airtime fairness for 5G: disable
trg_num: 2
> wl_dual artfns status
airtime fairness for 5G is disabled !!!
```

## Telnet Command: wl\_dual drays

This command allows the user to configure settings for Roaming for wireless clients.

## Syntax

```
wl_dual drays set <mode> <rs_low> <rs_low_security> <delta>
wl_dual drays restart
wl_dual drays show
```

## Syntax Description

| Parameter                                               | Description                                                                                |
|---------------------------------------------------------|--------------------------------------------------------------------------------------------|
| <i>set</i> <mode> <rs_low><br><rs_low_security> <delta> | Select a mode for roaming.<br>0 - disable<br>1 - Strictly Minimum RSSI<br>2 - Minimum RSSI |



|                |                                                                                                                                                                     |
|----------------|---------------------------------------------------------------------------------------------------------------------------------------------------------------------|
|                | rs_low - Set a value of Strictly Minimum RSSI (62-86).<br>rs_low_security - Set a value of Minimum RSSI (62-86).<br>delta - Set a value of Adjacent AP RSSI (1-20). |
| <i>restart</i> | Restart to activate roaming function.                                                                                                                               |
| <i>show</i>    | Display current configuration of roaming function.                                                                                                                  |

## Example

```

> wl_dual drayrs show
% Mode : Disable
% rs_low      : -73
% rs_low_secure : -66
% delta      : 5
> wl_dual drayrs set 1 68 66 2
> wl_dual drayrs show
% Mode : Strictly Minimum RSSI
% rs_low      : -68
% rs_low_secure : -66
% delta      : 2

```

## Telnet Command: radius

This command allows you to configure detailed settings for RADIUS server

### Syntax

```

radius enable <0/1>
radius authport <port number>
radius set_auth_method <method idx>
radius client add <idx> -i <address> -m <mask> -p <prefix> -l <length> -s <secret>
radius client del <idx>
radius show
radius enable_dot1x <0/1>
radius set_dot1x_method -e <method_idx>
radius set_dot1x_method -d <method_idx>

```

### Syntax Description

| Parameter                                                                          | Description                                                                                                                                                                                                                                                                                                                                               |
|------------------------------------------------------------------------------------|-----------------------------------------------------------------------------------------------------------------------------------------------------------------------------------------------------------------------------------------------------------------------------------------------------------------------------------------------------------|
| <i>enable</i> <0/1>                                                                | Enable (1) or disable (0) the RADIUS server.                                                                                                                                                                                                                                                                                                              |
| <i>authport</i> <port number>                                                      | Configure the port number for authentication.<br>Port number: Available range is from 0 to 65535.<br>Default value is "1812".                                                                                                                                                                                                                             |
| <i>set_auth_method</i> <method idx>                                                | Specify which method will be used for authentication.<br>Method idx: "0" is "Only PAP"; "1" is "PAP/CHAP/MS-CHAP/MS-CHAPv2".                                                                                                                                                                                                                              |
| <i>client add</i> <idx> -i <address> -m <mask> -p <prefix> -l <length> -s <secret> | Specify a client to be authenticated by RADIUS server by typing required information as follows:<br>-i <address>: client IPv4 address(domain)<br>-m <mask>: client IPv4 mask<br>-p <prefix>: client IPv6 prefix<br>-l <length>: client IPv6 prefix length<br>-s <secret>: shared secret<br>ex: radius client add 1 -i 192.168.1.1 -m 255.255.255.0 -s 123 |

|                                               |                                                                                                                                                                                                                                                |
|-----------------------------------------------|------------------------------------------------------------------------------------------------------------------------------------------------------------------------------------------------------------------------------------------------|
| <i>client del &lt;idx&gt;</i>                 | <i>del</i> - Delete related settings for selected client.<br><i>idx</i> - Specify the index number of client profiles.                                                                                                                         |
| <i>show</i>                                   | Display the status of RADIUS server.                                                                                                                                                                                                           |
| <i>enable_dot1x &lt;0/1&gt;</i>               | Enable (1) or disable (0) the 802.1X Authentication function of RADIUS Server. Default is disabled.                                                                                                                                            |
| <i>set_dot1x_method -e &lt;method_idx&gt;</i> | Set a method for 802.1X authentication of RADIUS server.<br>"-e" means to set method for dot1x_phase1 or dot1x_phase2.<br>Method idx: 1 to 4.<br>1: EAP_PEAP/MSCHAPv2<br>2: EAP_TTLS/PAP<br>3: EAP_TTLS/MSCHAP<br>4: EAP_TTLS/MSCHAPv2         |
| <i>set_dot1x_method -d &lt;method_idx&gt;</i> | Delete the method for 802.1X authentication of RADIUS server.<br>"-d" means to delete method for dot1x_phase1 or dot1x_phase2.<br>Method idx: 1 to 4.<br>1: EAP_PEAP/MSCHAPv2<br>2: EAP_TTLS/PAP<br>3: EAP_TTLS/MSCHAP<br>4: EAP_TTLS/MSCHAPv2 |

### Example

```
> radius client add 1 -i 192.168.1.1 -m 255.255.255.0 -s 123
  Set radius server client OK
>
```

## Telnet Command: radius external

This command allows you to configure detailed settings for external RADIUS server.

### Syntax

radius external *<options>...*

### Syntax Description

| Parameter                                | Description                                                                                                                                                          |
|------------------------------------------|----------------------------------------------------------------------------------------------------------------------------------------------------------------------|
| <i>&lt;options&gt;...</i>                | The available commands with parameters are listed below.<br>[...] means that you can type in several parameters in one line.                                         |
| <i>-V</i>                                | Displays current settings of external RADIUS server.                                                                                                                 |
| <i>-v &lt;index&gt;</i>                  | It means to display current setting of RADIUS server.<br><index>: Enter the index number (1).                                                                        |
| <i>-l &lt;index&gt;</i>                  | It means to display the log of the external RADIUS server.<br><index>: Enter the index number (1).                                                                   |
| <i>-c "&lt;index&gt;&lt;comment&gt;"</i> | It means to set a comment for the external RADIUS server.<br><index>: Enter the index number (1).<br><comment>: Enter a brief description (less than 23 characters). |
| <i>-f &lt;index&gt;</i>                  | Set the selected profile as the default external RADIUS profile.<br><index>: Enter the index number of the profile.                                                  |
| <i>-t &lt;param&gt;</i>                  | Set the timeout value.<br><param>: Enter a value.                                                                                                                    |
| <i>-e "&lt;index&gt;&lt;param&gt;"</i>   | Enable or disable the external RADIUS profile.<br><index>: Enter the index number of the profile.                                                                    |

|                                            |                                                                                                                                                                                                                                                                                              |
|--------------------------------------------|----------------------------------------------------------------------------------------------------------------------------------------------------------------------------------------------------------------------------------------------------------------------------------------------|
|                                            | <p>&lt;param&gt;: 0 or 1. 0 is disable; 1 is enable.<br/>ex: -e "2 1" to enable the profile 2</p>                                                                                                                                                                                            |
| -i "<index><index2><br><hostname/ip>"      | <p>Set the hostname or IP address for the selected RADIUS server profile.<br/>&lt;index&gt;: Enter the index number of the profile.<br/>&lt;index2&gt;: 0 or 1. 0 means the primary server; 1 means the secondary server.<br/>ex: -i "1 0 192.168.1.1" or -i "2 1 www.google.com"</p>        |
| -p "<index><index2><br><port_number>"      | <p>Set the destination port for the selected RADIUS server.<br/>&lt;index&gt;: Enter the index number of the profile.<br/>&lt;index2&gt;: 0 or 1. 0 means the primary server; 1 means the secondary server.<br/>&lt;port_number&gt;: 1 ~ 65535.<br/>ex : -p "1 1 1812"</p>                   |
| -s<br>"<index><index2><secret>"            | <p>Set the shared secret for the selected RADIUS server.<br/>&lt;index&gt;: Enter the index number of the profile.<br/>&lt;index2&gt;: 0 or 1. 0 means the primary server; 1 means the secondary server.<br/>&lt;secret&gt;: 1 ~ 65535.<br/>ex : -s "3 0 123"</p>                            |
| -r "<index><index2><retry>"                | <p>Set the retry number for the selected RADIUS server.<br/>&lt;index&gt;: Enter the index number of the profile.<br/>&lt;index2&gt;: 0 or 1. 0 means the primary server; 1 means the secondary server.<br/>&lt;retry&gt;: 1 to 3.<br/>ex : -s "3 0 2"</p>                                   |
| -a "<index><param>"                        | <p>Enable or disable the accounting port for the selected RADIUS server.<br/>&lt;index&gt;: Enter the index number of the profile.<br/>&lt;param&gt;: 0 or 1. 0 is disable; 1 is enable.</p>                                                                                                 |
| -b "<index><index2><br><port_number>"      | <p>Set the accounting port for the selected RADIUS server.<br/>&lt;index&gt;: Enter the index number of the profile.<br/>&lt;index2&gt;: 0 or 1. 0 means the primary server; 1 means the secondary server.<br/>&lt;port_number&gt;: 1 ~ 65535.<br/>ex : -b "1 0 1813"</p>                    |
| -d "<index><index2><br><port_number>"      | <p>Disconnect the message port for the selected RADIUS server.<br/>&lt;index&gt;: Enter the index number of the profile.<br/>&lt;index2&gt;: 0 or 1. 0 means the primary server; 1 means the secondary server.<br/>&lt;port_number&gt;: 1 ~ 65535.<br/>ex : -d "1 1 3799"</p>                |
| -u "<index> <index2><br><update interval>" | <p>Set the accounting interim interval for the selected RADIUS server.<br/>&lt;index&gt;: Enter the index number of the profile.<br/>&lt;index2&gt;: 0 or 1. 0 means the primary server; 1 means the secondary server.<br/>&lt;port_number&gt;: 10 ~ 1440 (minutes)<br/>ex : -u "1 0 10"</p> |

## Example

```

> radius external -i "1 0 192.168.1.1"
  This setting will take effect after rebooting.
  Please use "sys reboot" command to reboot the router.
> radius external -V

```

```

Profile default enable comment
% 1      v
RADIUS timeout: 2 seconds

```

## Telnet Command: local\_8021x

The command is used to configure general settings for Local 802.1X server built in Vigor router.

### Syntax

```

local_8021x enable <0/1>
local_8021x set_localdot1x_method -e <method number>
local_8021x set_localdot1x_method -d <method number>
local_8021x show

```

### Syntax Description

| Parameter                                             | Description                                                                                                                                                                                                                             |
|-------------------------------------------------------|-----------------------------------------------------------------------------------------------------------------------------------------------------------------------------------------------------------------------------------------|
| <i>enable</i>                                         | Enable or disable the configuration.<br>0: disable.<br>1: enable.                                                                                                                                                                       |
| <i>set_localdot1x_method -e &lt;method number&gt;</i> | Add the method.<br>-e [method number]: Set the method.<br>The method index number are:<br>1 - EAP_PEAP/MSCHAPv2<br>2 - EAP_TTLS/PAP<br>3 - EAP_TTLS/MSCHAP<br>4 - EAP_TTLS/MSCHAPv2<br>e.g, local_8021x set_localdot1x_method-e 1       |
| <i>set_localdot1x_method -d &lt;method number&gt;</i> | Delete the method.<br>-d [method number]: Delete the method.<br>The method index number are:<br>1 - EAP_PEAP/MSCHAPv2<br>2 - EAP_TTLS/PAP<br>3 - EAP_TTLS/MSCHAP<br>4 - EAP_TTLS/MSCHAPv2<br>e.g, local_8021x set_localdot1x_method-d 3 |
| <i>show</i>                                           | Display current settings of local 802.1x server.                                                                                                                                                                                        |

### Example

```

> local_8021x set_localdot1x_method -e 3
This setting will take effect after rebooting.
Please use "sys reboot" command to reboot the router.
>

```

## Telnet Command: wol

This command allows Administrator to set the white list of WAN IP addresses/Subnets, that the magic packet from these IP addresses/Subnets will be eligible to pass through NAT and wake up the LAN client. You also need to set NAT rule for LAN client.

### Syntax

```

wol up <MAC Address> / <IP Address>

```

wol fromWan <on/off/any>  
 wol fromWan\_Setting <idx><ip address><mask>

### Syntax Description

| Parameter               | Description                                                                                                                                                                                                                                                                                                                           |
|-------------------------|---------------------------------------------------------------------------------------------------------------------------------------------------------------------------------------------------------------------------------------------------------------------------------------------------------------------------------------|
| <MAC Address>           | It means the MAC address of the host.                                                                                                                                                                                                                                                                                                 |
| <IP address>            | It means the LAN IP address of the host. If you want to wake up LAN host by using IP address, be sure that that IP address has been bound with the MAC address (IP BindMAC).                                                                                                                                                          |
| <on/off/any>            | It means to enable or disable the function of WOL from WAN.<br>on: enable<br>off: disable<br>any: It means any source IP address can pass through NAT and wake up the LAN client.<br>This command will allow the user to choose whether WoL packets can be passed from the Internet to the LAN network from a specific WAN interface. |
| <idx><ip address><mask> | It means the index number (from 1 to 4).<br>These commands will allow the user to configure the LAN clients that the user may wake up from the Internet through the use of the WoL packet.<br><i>ip address</i> - It means the WAN IP address.<br><i>mask</i> - It means the mask of the IP address.                                  |

### Example

```
> wol fromWan on
> wol fromWan_Setting 1 192.168.1.45 255.255.255.0
>
```

## Telnet Command: user

The command is used to create new user account profiles.

### Syntax

user set <-a/-b/-c/-d/-e/-f/-g/-h/-i/-j/-k/-l/-m/-n/-o/-p/-q/-r/-s/-t/>  
 user edit <PROFILE\_IDX>  
 <-a/-d/-e/-f/-g/-h/-i/-j/-k/-l/-m/-n/-o/-p/-q/-r/-s/-t/-u/-v/-w/-x/-A/-H/-T/-P/-I/-L/-D>  
 user account <USER\_NAME><-t/-d/-q/-r/-w>  
 user setdefault

### Syntax Description

| Parameter                                       | Description                                                                                    |
|-------------------------------------------------|------------------------------------------------------------------------------------------------|
| <i>set</i>                                      | It means to configure general setup for the user management.                                   |
| <i>edit</i>                                     | It means to modify the selected user profile.                                                  |
| <i>account</i>                                  | It means to set time and data quota for specified user account.                                |
| <i>setdefault</i>                               | It means to reset to factory default settings.                                                 |
| <b>User Set</b>                                 |                                                                                                |
| <i>-a</i> <Profile idx> <User name><IP_Address> | It means to pass an IP Address.<br>Profile idx- type the index number of the selected profile. |

|                                           |                                                                                                                                                                                                                                           |
|-------------------------------------------|-------------------------------------------------------------------------------------------------------------------------------------------------------------------------------------------------------------------------------------------|
|                                           | User name- type the user name that you want it to pass.<br>IP_Address- type the IP address that you want it to pass.                                                                                                                      |
| -b <user name><br>-b ip <ip address>      | Block specifies user or IP address.<br><i>user name</i> - type the user name that you want to block.<br><i>ip address</i> -- type the IP address that you want to block.                                                                  |
| -c <user name><br>-c all                  | Clear the user record.<br><i>user name</i> - type the user name that you want to get clear corresponding record.<br><i>all</i> - all of the records will be removed.                                                                      |
| -d                                        | Enable the User management in Rule-Based mode.                                                                                                                                                                                            |
| -e                                        | Enable the User management in User-Based mode.                                                                                                                                                                                            |
| -l all<br>-l user<br>-l ip                | Show online user.<br><i>all</i> - all of the users will be displayed on the screen.<br><i>user name</i> - type the user name that you want to view on the screen.<br><i>ip</i> - type the IP address that you want to view on the screen. |
| -o                                        | It means to show user account information.<br>e.g., -o                                                                                                                                                                                    |
| -q                                        | It means to trigger the alert tool to do authentication.                                                                                                                                                                                  |
| -r <user name / all>                      | Remove the user record.<br><i>user name</i> - type the name of the user profile.<br><i>all</i> - all of the user profile settings will be removed.                                                                                        |
| -s <0/1>                                  | It means to set login service.<br>0:HTTPS<br>1:HTTP<br>e.g., -s 1                                                                                                                                                                         |
| -u user <user name><br>-u ip <ip address> | Unblock specifies user or IP address.<br><i>user name</i> - type the user name that you want to unblock.<br><i>ip address</i> -- type the IP address that you want to unblock.                                                            |
| <b>User edit</b>                          |                                                                                                                                                                                                                                           |
| PROFILE_IDX                               | Type the index number of the profile that you want to edit.                                                                                                                                                                               |
| -a <0/1>                                  | Enable(1) or disable(0) the internal RADIUS.                                                                                                                                                                                              |
| -d                                        | Disable User profile function.                                                                                                                                                                                                            |
| -e                                        | Enable User profile function.                                                                                                                                                                                                             |
| -f <0/1>                                  | Enable(1) or disable(0) the local 802.1x user.                                                                                                                                                                                            |
| -i <0-255>                                | It means to set idle time (from 0 to 255, 0 means unlimited).<br>e.g., -i 60                                                                                                                                                              |
| -o <0-65535>                              | It means to set auto-logout (from 0 to 65535, 0 means unlimited).                                                                                                                                                                         |
| -m <0-2000>                               | It means to set the maximum (from 0 to 2000) login user number.<br>e.g., -m 200                                                                                                                                                           |
| -n <param>                                | It means to set a user name for a profile.<br>Param: Enter a string, e.g., -n forttest.                                                                                                                                                   |
| -p <param>                                | It means to configure user password.<br>Param: Enter a string, e.g., -p 60forttest.                                                                                                                                                       |
| -q <param>                                | It means to set time quota (0-65535) of the user profile.<br>Param: Enter a value, e.g., -q 200.                                                                                                                                          |
| -r <param>                                | It means to set data quota.                                                                                                                                                                                                               |

|                                                                                 |                                                                                                                                     |
|---------------------------------------------------------------------------------|-------------------------------------------------------------------------------------------------------------------------------------|
|                                                                                 | Param: Enter a value, e.g., <i>-r 1000</i> .                                                                                        |
| <i>-s</i><br><i>&lt;sch_idx1,sch_idx2,sch_idx3</i><br><i>, and sch_idx4&gt;</i> | It means to set schedule index. Available settings are”<br>sch_idx1,sch_idx2,sch_idx3, and sch_idx4.                                |
| <i>-t &lt;0/1&gt;</i>                                                           | It means to enable /disable time quota limitation for user profile<br>0:Disable<br>1:Enable                                         |
| <i>-u &lt;0/1&gt;</i>                                                           | It means to enable /disable data quota limitation for user profile<br>0:Disable<br>1:Enable                                         |
| <i>-v</i>                                                                       | It means to view user profile(s).                                                                                                   |
| <i>-w &lt;MB/GB&gt;</i>                                                         | It means to specify the data quota unit (MB/GB).<br>e.g., <i>-w MB</i>                                                              |
| <i>-x &lt;0-3&gt;</i>                                                           | It means to set external server authentication<br>0: None<br>1: LDAP<br>2: Radius<br>3: TACAS<br>e.g., <i>-x 2</i>                  |
| <i>-l &lt;0-3&gt;</i>                                                           | It means to set log type.<br>0:None<br>1:Login<br>2:Event<br>3:All                                                                  |
| <i>-P &lt;0/1&gt;</i>                                                           | It means to enable /disable pop browser tracking window for user profile<br>0:Disable<br>1:Enable                                   |
| <i>-T &lt;0/1&gt;</i>                                                           | It means to enable /disable authentication by telnet.<br>0:Disable<br>1:Enable                                                      |
| <i>-H &lt;0/1&gt;</i>                                                           | It means to enable /disable authentication by web page.<br>0:Disable<br>1:Enable                                                    |
| <i>-A &lt;0/1&gt;</i>                                                           | It means to enable /disable authentication by alert tool.<br>0:Disable<br>1:Enable                                                  |
| <i>-L &lt;index&gt;</i>                                                         | It means to set active directory / LDAP profiles.<br>Index: Specify the index number (profile_idx1 to profile_idx8) of the profile. |
| <i>-D</i>                                                                       | It means to list all active directory / LDAP profiles.                                                                              |
| <i>-O &lt;0/1&gt;</i>                                                           | It means to reset the quota automatically.<br>0:Disable<br>1:Enable                                                                 |
| <i>-Q &lt;param&gt;</i>                                                         | It means to set the default time quota.<br>param: Enter a number (1 to 65535).                                                      |
| <i>-R &lt;param&gt;</i>                                                         | It means to set the default data quota.<br>param: Enter a number (1 to 65535).                                                      |
| <i>-M &lt;param&gt;</i>                                                         | It means to set the default quota type.                                                                                             |

|                     |                                                                                              |
|---------------------|----------------------------------------------------------------------------------------------|
|                     | 0: when login permission schedule expired.<br>1: at the start time of schedule.              |
| <i>l</i> <param>    | It means to specify the default quota schedule index to perform the job at the start time.   |
| -S                  | It means to display the reset default quota type and the schedule index.                     |
| <i>User account</i> |                                                                                              |
| <i>USER_NAME</i>    | It means to type a name of the user account.                                                 |
| -d<0/1>             | It means to enable /disable data quota limitation for user account.<br>0:Disable<br>1:Enable |
| -q                  | It means to set account time quota.<br>e.g., -q 200                                          |
| -r                  | It means to set account data quota.<br>e.g., -r 1000                                         |
| -t <0/1>            | It means to enable /disable time quota limitation for user account.<br>0:Disable<br>1:Enable |
| -w                  | It means to set data quota unit (MB/GB).                                                     |

## Example

```
> user account admin -d 1
Enable the [admin] data quota limited
```

## Telnet Command: appqos

The command is used to configure QoS for APP.

### Syntax

appqos view

appqos enable <0/1>

appqos traceable <-v | -e AP\_INDEX CLASS | -d AP\_INDEX>

appqos untraceable <-v | -e AP\_INDEX CLASS | -d AP\_INDEX>

### Syntax Description

| Parameter                     | Description                                                                                                                                                                                                                                    |
|-------------------------------|------------------------------------------------------------------------------------------------------------------------------------------------------------------------------------------------------------------------------------------------|
| <i>view</i>                   | It means to display current status of APP QoS.                                                                                                                                                                                                 |
| <i>enable</i> <0/1>           | It means to enable or disable the function of APP QoS.                                                                                                                                                                                         |
| <i>traceable/ untraceable</i> | The APPs are divided into traceable and untraceable based on their properties.                                                                                                                                                                 |
| -v                            | It means to view the content of all traceable APs.<br>Use “appqos traceable -v” to display all of the traceable APS with spified index number.<br>Use “appqos untraceable -v” to display all of the untraceable APS with spified index number. |
| -e                            | It menas to enable QoS for application(s) and assign QoS class.                                                                                                                                                                                |
| <i>AP_INDEX</i>               | Each index number represents one application.<br>Index number: 50, 51, 52, 53, 54, 58, 60, 62, 63, 64, 65, 66, 68 are used for 13 traceabel APPs.                                                                                              |



|              |                                                                                                           |
|--------------|-----------------------------------------------------------------------------------------------------------|
|              | Index number: 0-49, 55-59, 61, 67, 69, and 70-123 are used for 125 untraceable AP.                        |
| <i>CLASS</i> | Specifies the QoS class of the application, from 1 to 4<br>1:Class 1, 2:Class 2, 3:Class 3, 4:Other Class |
| <i>-d</i>    | It means to disable QoS for application(s).                                                               |

### Example

```
> appqos enable 1

APP QoS set to Enable.
> appqos traceable -e 68 2

TELNET: ENABLED, QoS Class 2.
```

### Telnet Command: nand bad /nand usage

“NAND usage” is used to display NAND Flash usage; “nand bad” is used to display NAND Flash bad blocks.

#### Syntax

```
nand bad
nand usage
```

#### Example

```
>nand usage
Show NAND Flash Usage:
Partition      Total          Used           Available      Use%
cfg            4194304        7920           4186384        0%
bin_web       33554432       11869493       21684939       35%
cfg-bak       4194304        7920           4186384        0%
bin_web-bak   33554432       11869493       21684939       35%
> nand bad
Show NAND Flash Bad Blocks:
Block  Address          Partition
1020   0x07f80000      unused
1021   0x07fa0000      unused
1022   0x07fc0000      unused
1023   0x07fe0000      unused
```

### Telnet Command: apm enable/disable/show/clear/discover/query

The apm command(s) is use to display, remove, discover or query the information of VigorAP registered to Vigor2927.

#### Syntax

```
apm enable
apm disable
apm show
apm clear
apm discover
apm query
```

## Syntax Description

| Parameter       | Description                                                                                                                                                                                                                        |
|-----------------|------------------------------------------------------------------------------------------------------------------------------------------------------------------------------------------------------------------------------------|
| <i>enable</i>   | It means to enable APM function.                                                                                                                                                                                                   |
| <i>disable</i>  | It means to disable APM function.                                                                                                                                                                                                  |
| <i>show</i>     | It displays current information of APM profile.                                                                                                                                                                                    |
| <i>clear</i>    | It is used to remove all of the APM profile.                                                                                                                                                                                       |
| <i>discover</i> | It is used to search VigorAP on LAN.                                                                                                                                                                                               |
| <i>query</i>    | It is used to query any VigorAP which has been registered to APM (Central AP Management) in Vigor2927. Information related to the registered AP will be send back to Vigor2927 for updating the web page of Central AP Management. |

## Example

```
> apm clear ?  
Clear all clients ... done
```

## Telnet Command: apm profile

This command allows to configure wireless profiles to be used in Central AP Management.

## Syntax

```
apm profile clone <from index><to index><new name>  
apm profile del <index>  
apm profile reset  
apm profile summary  
apm profile show <profile index>  
apm profile apply <profile index> <client index1 index2 .. index5>
```

## Syntax Description

| Parameter                        | Description                                                                                                                       |
|----------------------------------|-----------------------------------------------------------------------------------------------------------------------------------|
| <i>clone</i>                     | It is used to copy the same parameters settings from one profile to another APM profile.                                          |
| <i>del</i>                       | It is used to delete a specified APM profile. The default (index #1) should not be deleted.                                       |
| <i>reset</i>                     | It is used to reset to factory settings for WLAN profile.                                                                         |
| <i>summary</i>                   | It is used to list all of the APM profiles with required information.                                                             |
| <i>show</i>                      | It is used to display specified APM profile.                                                                                      |
| <i>apply</i>                     | It is used to apply the selected APM profile onto specified VigorAP.                                                              |
| <from index>                     | Type an index number in this field. It is the original APM profile to be cloned to other APM profile.                             |
| <to index>                       | Type an index number in this file. It is the target profile which will clone the parameters settings from an existed APM profile. |
| <new name>                       | Type a name for a new APM profile.                                                                                                |
| <profile index>                  | Enter the index number of existed profile.                                                                                        |
| <client index1 index2 .. index5> | It is useful for applying the selected APM profile to the specified VigorAP.                                                      |

## Example

```

> apm profile clone 1 2 forcarrie
(Done)

> apm profile summary
# Name          SSID          Security    ACL    RateCtrl(U/D)
-----
0 Default      DrayTek-LAN-A WPA+WPA2/PSK x      - / -
                DrayTek-LAN-B WPA+WPA2/PSK x      - / -
1 -            -            -          -      -
2 forcarrie    DrayTek       Disable     x      - / -
3 -            -            -          -      -
4 -            -            -          -      -

```

### Telnet Command: apm cache

This command is used to display or remove the information of registered VigorAP, including MAC address, name, and authentication. Up to 30 entries of registered information can be stored and displayed.

#### Syntax

apm cache <show>

apm cache clear

#### Syntax Description

| Parameter    | Description                                                                  |
|--------------|------------------------------------------------------------------------------|
| <i>show</i>  | It means to display the information related to VigorAP registered Vigor2927. |
| <i>clear</i> | It means to remove the information related to VigorAP registered Vigor2927.  |

#### Example

```

> apm cache show
MAC          Name          Auth
-----
>

```

### Telnet Command: apm lbcfg

This command allows to set parameters related to AP management control.

#### Syntax

apm lbcfg set <value>

apm lbcfg show

#### Syntax Description

| Parameter   | Description                                                  |
|-------------|--------------------------------------------------------------|
| <i>set</i>  | It means to set the load balance configuration file for APM. |
| <i>Show</i> | It shows the configuration value.                            |

|                            |                                                                                                                                                                                                                                                                                                                                                                                                                                                                                                                                                                                                                                                                                                                                                                                                                                                                                                                                                                                                                                                                                                                                                                                                                                                                                                                                                                                                                                                                                                                                      |
|----------------------------|--------------------------------------------------------------------------------------------------------------------------------------------------------------------------------------------------------------------------------------------------------------------------------------------------------------------------------------------------------------------------------------------------------------------------------------------------------------------------------------------------------------------------------------------------------------------------------------------------------------------------------------------------------------------------------------------------------------------------------------------------------------------------------------------------------------------------------------------------------------------------------------------------------------------------------------------------------------------------------------------------------------------------------------------------------------------------------------------------------------------------------------------------------------------------------------------------------------------------------------------------------------------------------------------------------------------------------------------------------------------------------------------------------------------------------------------------------------------------------------------------------------------------------------|
| <code>&lt;value&gt;</code> | <p>You need to type 10 numbers in this field. Each number represents different setting value.</p> <p>[1] - The first number means the load balance function. Type<br/>1 - enable load balance,<br/>0 - disable load balance.</p> <p>[2] - The second number means the station limit function. Type<br/>1 -enable station limit,<br/>0 - disable station limit.</p> <p>[3] - The third number means the traffic limit function. Type<br/>1 - enable traffic limit,<br/>0 - disable traffic limit.</p> <p>[4] - The forth number means the limit num of station.<br/>Available range is 3-64.</p> <p>[5] - The fifth number means the upload limit function. Type<br/>1 - enable upload limit,<br/>0 - disable upload limit.</p> <p>[6] - The sixth number means the download limit function.<br/>Type<br/>1 - enable download limit,<br/>0 - disable download limit.</p> <p>[7] - The seventh number means disassociation by idle time.<br/>Type<br/>1 - enable disassociation,<br/>0 - disable disassociation.</p> <p>[8] - The eighth number means to enable or disable disassociation by signal strength. Type<br/>1 - enable disassociation,<br/>0 - disable disassociation.</p> <p>[9] - The ninth number means to determine the unit of traffic limit (for upload)<br/>1 - Mbps<br/>0 - kbps</p> <p>[10] - The tenth number means to determine the unit of traffic limit (for download)<br/>1 - Mbps<br/>0 - kbps</p> <p>[11] - The eleventh number means to set the RSSI threshold.<br/>Available range is -200 - -50 dbm.</p> |
|----------------------------|--------------------------------------------------------------------------------------------------------------------------------------------------------------------------------------------------------------------------------------------------------------------------------------------------------------------------------------------------------------------------------------------------------------------------------------------------------------------------------------------------------------------------------------------------------------------------------------------------------------------------------------------------------------------------------------------------------------------------------------------------------------------------------------------------------------------------------------------------------------------------------------------------------------------------------------------------------------------------------------------------------------------------------------------------------------------------------------------------------------------------------------------------------------------------------------------------------------------------------------------------------------------------------------------------------------------------------------------------------------------------------------------------------------------------------------------------------------------------------------------------------------------------------------|

## Example

```

> apm lbcfg show
apm LoadBalance Config :
1. Enable LoadBalance : 0
2. Enable station limit : 0
3. Enable traffic limit : 0
4. limit Number : 64
5. Upload limit : 0
6. Download limit : 0
7. Enable disassociation by idle time : 0
8. Enable disassociation by Signal strength : 0
9. Traffic limit unit (upload) : 0
10.Traffic limit unit (download) : 0
11.RSSI threshold : 0
flag : 0

```

```

> apm lbcfg set 1 1 0 15 0 0 0 0 1 1 -100
> apm lbcfg show
apm LoadBalance Config :
1. Enable LoadBalance : 1
2. Enable station limit : 1
3. Enable traffic limit : 0
4. limit Number : 15
5. Upload limit : 0
6. Download limit : 0
7. Enable disassociation by idle time : 0
8. Enable disassociation by Signal strength : 0
9. Traffic limit unit (upload) : 1
10. Traffic limit unit (download) : 1
11. RSSI threshold : -100
flag : 49
>

```

## Telnet Command: apm apsyslog

This command is used to display the AP syslog data coming from VigorAP.

### Syntax

apm apsyslog <AP\_Index>

### Syntax Description

| Parameter | Description                                                  |
|-----------|--------------------------------------------------------------|
| AP_Index  | Specify the index number (1 to 20) which represents VigorAP. |

### Example

```

> apm apsyslog 1
8d 02:46:09 syslog: [APM] Send Rogue AP Detection data.
8d 02:53:04 syslog: [APM] Run AP Detection / Discovery.
8d 02:56:09 syslog: [APM] Send Rogue AP Detection data.
8d 03:00:42 kernel: 60:fa:cd:55:f5:ea had disassociated.
8d 03:03:12 syslog: [APM] Run AP Detection / Discovery.
8d 03:06:09 syslog: [APM] Send Rogue AP Detection data.
8d 03:13:21 syslog: [APM] Run AP Detection / Discovery.
8d 03:16:10 syslog: [APM] Send Rogue AP Detection data.
8d 03:16:41 kernel: 60:fa:cd:55:f5:ea had associated successfully
8d 03:16:55 kernel: 60:fa:cd:55:f5:ea had disassociated.

```

## Telnet Command: apm syslog

This command is used to display related syslog data from central AP management.

### Syntax

apm syslog

### Example

```

> apm syslog
"2015-11-04 12:24:21", "[APM] [VigorAP900_01daa902080] Get Rogue AP Detection
Data from AP"
2015-11-04 12:24:56", "[APM] [VigorAP900_01daa902080] Get Rogue AP Detection
Data from AP Success"
2015-11-04 12:34:21", "[APM] [VigorAP900_01daa902080] Get Rogue AP Detection

```

```
Data from AP"
2015-11-04 12:34:57", "[APM] [VigorAP900_01daa902080] Get Rogue AP Detection
Data from AP Success"
```

## Telnet Command: apm stanum

This command is used to display the total number of the wireless clients, no matter what mode of wireless connection (2.4G WLAN or 5G WLAN) used by wireless clients to access into Internet through VigorAP.

### Syntax

apm stanum <AP\_Index>

### Syntax Description

| Parameter | Description                                        |
|-----------|----------------------------------------------------|
| AP_Index  | Specify the index number which represents VigorAP. |

### Example

```
> apm stanum

% Show the APM AP Station Number data.
% apm stanum AP_Index.
%   ex : apm stanum 1
%       Idx  Nearby(2.4/5G)  Conn(2.4/5G)
%       1    2    5           0    0
%       2    2    5           1    0
%       3    2    5           1    0
```

## Telnet Command: ha set

This command can be used to configure HA settings for Vigor routers.

### Syntax

ha set [-<command> <parameter>| ... ]

### Syntax Description

| Parameter                      | Description                                                                                                                                             |
|--------------------------------|---------------------------------------------------------------------------------------------------------------------------------------------------------|
| [<command><br><parameter> ...] | The available commands with parameters are listed below.<br>[...] means that you can Enter several parameters in one line.                              |
| -e <1/0>                       | 1: Enable the function of High Availability (HA).<br>0: Disable the function of High Availability (HA).                                                 |
| -l <1/0>                       | 1: Enable the function of recording the operation record of HA in Syslog.<br>0: Disable the function of recording the operation record of HA in Syslog. |
| -M <1/0>                       | Specify the Redundancy Method for HA.<br>1: Active-Standby<br>0: Hot-Standby                                                                            |
| -v <1-255>                     | Specify the group ID (VHID)<br>1- 255: Setting range.                                                                                                   |
| -R                             | Set HA settings to Factory Default.                                                                                                                     |
| -p <1-30>                      | Specify the Priority ID.<br>1-30: Setting range.                                                                                                        |

|                                                               |                                                                                                                                                                                                                                                                                        |
|---------------------------------------------------------------|----------------------------------------------------------------------------------------------------------------------------------------------------------------------------------------------------------------------------------------------------------------------------------------|
| <code>-k &lt;key&gt;</code>                                   | Specify the Authentication Key.<br>Key: Max. 31 Characters.                                                                                                                                                                                                                            |
| <code>-u &lt;1/0&gt;</code>                                   | Enable or disable the function of Update DDNS.<br>1: Enable. When a router changes HA status to primary, it will update DDNS automatically.<br>0: Disable.                                                                                                                             |
| <code>-m &lt;interface&gt;</code>                             | Specify the management interface.<br>Interface: LAN1 - LAN6, DMZ.                                                                                                                                                                                                                      |
| <code>-s</code>                                               | It means to get the newest status of other router (except the local router).                                                                                                                                                                                                           |
| <code>-y</code>                                               | It means sync local config to other router. Primary can executes this command. Secondary can not execute this commad.                                                                                                                                                                  |
| <code>-c &lt;1/0&gt;</code>                                   | Enable or disable the function of Config Sync.<br>1: Enable.<br>0: Disable.                                                                                                                                                                                                            |
| <code>-i -&lt;E/S&gt; &lt;value&gt;</code>                    | Specify the config inherit setting.<br>-E <1/0> - Enable/Disable Config Inherit<br>-S <min> - Config Inherit Resync Time(1-60 min)<br>ex: ha set -i -S 15                                                                                                                              |
| <code>-I -&lt;M/H/D&gt; &lt;interval&gt;</code>               | Set the Config Sync Interval for HA. Minimum interval is 15 minutes.<br>-M: Minute. Setting range is 0/15/30/45. (e.g., ha set -I -M 30)<br>-H: Hour. Setting range is from 0 to 23. (e.g., ha set -I -H 12)<br>-D: Day. Setting range is from 0 to 30. (e.g., ha set -I -D 15)        |
| <code>-h -&lt;4/6&gt;&lt;Subnet&gt; &lt;Virtual IP&gt;</code> | Enable and set virtual IP to the subnet.<br>4: IPv4; 6: IPv6.<br>Subnet: LAN1 to LAN6, DMZ.<br>Virtual IP: The type format shall be "xxx.xxx.xxx.xxx". (e.g, 192.168.1.0)<br>For example, to enable a virtual IP to the sunet, simply type:<br><code>ha set -h LAN1 192.168.1.5</code> |
| <code>-d -&lt;4/6&gt;&lt;Subnet&gt;</code>                    | Disable a virtual IP to the subnet.<br>4: IPv4; 6: IPv6.<br>Subnet: LAN1 to LAN8, DMZ.<br>For example, to disable a virtual IP to the subnet, just type:<br><code>ha set -h LAN1</code>                                                                                                |
| <code>-o &lt;1/0&gt;</code>                                   | Run DARP protocol on IPv4 or IPv6.<br>0: IPv4<br>1: IPv6                                                                                                                                                                                                                               |

## Example

```
> ha set -h -4 LAN1 192.168.1.1
% Enable IPv4 Virtual IP on LAN1
% Virtual IP can not be same as router IP (192.168.1.1)!!!
>
```

## Telnet Command: ha show

This command can be used to show the *settings information* about config sync and general setup.

## Syntax

```
ha show -c
ha show -g
```

## Syntax Description

| Parameter | Description                         |
|-----------|-------------------------------------|
| -c        | Show the settings of config sync.   |
| -g        | Show the settings of general setup. |

## Example

```
> ha show -g
% High Availability      : Disable
% Redundancy Method    : Active-Standby
% Group ID             : 1
% Priority ID          : 10
% Update DDNS         : Disable
% Protocol             : IPv4
% Management Interface : LAN1
% Authentication Key   : draytek
% Syslog               : OFF
%
% [ Index | Enable | Virtual IP ]
% LAN1    -      192.168.1.2
% LAN2    -      192.168.2.2
% LAN3    -      192.168.3.2
% LAN4    -      192.168.4.2
% LAN5    -      192.168.5.2
% LAN6    -      192.168.6.2
% LAN7    -      192.168.7.2
% LAN8    -      192.168.8.2
% DMZ     -      192.168.254.2
%
% [ Index | Enable | Virtual IPv6 ]
% LAN1    On      FE80::200:5EFF:FE00:101
% LAN2    On      FE80::200:5EFF:FE00:101
% LAN3    On      FE80::200:5EFF:FE00:101
% LAN4    On      FE80::200:5EFF:FE00:101
% LAN5    On      FE80::200:5EFF:FE00:101
% LAN6    On      FE80::200:5EFF:FE00:101
% LAN7    On      FE80::200:5EFF:FE00:101
% LAN8    On      FE80::200:5EFF:FE00:101
% DMZ     On      FE80::200:5EFF:FE00:101
>
```

## Telnet Command: ha status

This command is used to display *HA status information*.

## Syntax

```
ha status -a <Detail Level>
ha status -m <Detail Level>
```

## Syntax Description

| Parameter      | Description                                                                             |
|----------------|-----------------------------------------------------------------------------------------|
| -a             | Show the status for all of the routers in HA group.                                     |
| -m             | Show the status of local router only.                                                   |
| <Detail Level> | 0: Important status.<br>1: Important status, plus some information.<br>2: Show settings |



## Example

```
> ha status -m 2
% [Local Router] DrayTek
% IP : 192.168.1.230 (FE80::C3F7:BAD:C1EF:CC4E)
% Status : !
% High Availability : ! Disable
% Redundancy Method : Active-Standby
% Group ID : 1
% Priority ID : 10
% Update DDNS : Disable
% Protocol : IPv4
% Management Interface: LAN1
% Authentication Key : draytek
% Virtual IP: (Max. 9 Virtual IPs)
% ! OFF
% Virtual IPv6: (Max. 9 Virtual IPv6s)
% ON LAN1 FE80::200:5EFF:FE00:101
% ON LAN2 FE80::200:5EFF:FE00:101
% ON LAN3 FE80::200:5EFF:FE00:101
% ON LAN4 FE80::200:5EFF:FE00:101
% ON LAN5 FE80::200:5EFF:FE00:101
% ON LAN6 FE80::200:5EFF:FE00:101
% ON LAN7 FE80::200:5EFF:FE00:101
% ON LAN8 FE80::200:5EFF:FE00:101
% ON DMZ FE80::200:5EFF:FE00:101
% Config Sync : Disable
% Config Sync Interval : 0 Day 0 Hour 15 Minute
% Cached Time : 0 (s)
%
>
```

## Telnet Command: swm show

This command is used to display general setting of of VigorSwitch which connecting to Vigor router in LAN.

### Syntax

swm show <LAN\_port>

### Syntax Description

| Parameter | Description                           |
|-----------|---------------------------------------|
| LAN_port  | Specify the LAN port number (1 to 6). |

## Example

```
DrayTek> swm show

** If you want to display SWM debug log : "swm show debug log"
** Enable/Disable SWM console debug log : "swm show console log en/dis"
** Enable/Disable SWM syslog debug log : "swm show syslog log en/dis"

** If you connected a VigorSwitch but does not display here.
** Please check the LLDP is enabled and VLAN ID is matched on VigorSwitch.
```

```

*****
*****
LAN Port Level UP - Link Model UP - MAC UP - Port Model Name MA
C IP Address Down - Port
-----
2 1 Router 6 G2100 1
449BC43E579 192.168.1.13
-----

*** Warning Message: The External Switch Change Detected
*****

Internal VLAN is [Disable]
LAN (2) parse config fail
-----

No VigorSwitch VLAN settings.
*****

*****
*****
LAN Port Level UP - Link Model UP - MAC UP - Port Model Name MA
C IP Address Down - Port
-----
4 1 Router 2 G2121 1
449BC4133F4 192.168.1.11
-----

*** Warning Message: The External Switch Change Detected
*****

Internal VLAN is [Disable]
LAN (4) parse config fail
-----

No VigorSwitch VLAN settings.
*****

```

(Total 0 Switch)

## Telnet Command: swm get

This command is used to get configuration information of VigorSwitch which connecting to Vigor router in LAN. Before using such command, make sure VigorSwitch has been managed under Vigor router (refer to Telnet Command: swm profile for adding a VigorSwitch device onto Vigor router).

### Syntax

swm get <MAC>

### Syntax Description

| Parameter | Description                                                    |
|-----------|----------------------------------------------------------------|
| MAC       | Enter the MAC address (e.g., 001DAA0CCD08) of the VigorSwitch. |

### Example

```
> swm get 001DAA0CCD08
Start get cfg from 001daa0ccd08 external switch

Please wait a few seconds...

Result: [OK].

>
```

## Telnet Command: swm post

This command is used to transfer switch configuration to VigorSwitch which connecting to Vigor router in LAN.

### Syntax

swm post <MAC>

### Syntax Description

| Parameter | Description                                                    |
|-----------|----------------------------------------------------------------|
| MAC       | Enter the MAC address (e.g., 001DAA0CCD08) of the VigorSwitch. |

### Example

```
> swm post 001DAA0CCD08
Start post cfg to 001daa0ccd08 external switch with current settings.
Please wait a few seconds...
Result: [OK].
>
```

## Telnet Command: swm enable / disable

This command is used to enable / disable the external device.

### Example

```
> swm enable
```

## Telnet Command: swm group

This command is used to add, edit or display the switch management group.

## Syntax

```
swm group set <IDX> <NAME> <1> <PASSWD>
swm group set <IDX> <NAME> <0>
swm group show
swm group add <IDX> <MAC>
swm group delete <IDX> <MAC>
```

## Syntax Description

| Parameter                               | Description                                                                                                                                                                                                                      |
|-----------------------------------------|----------------------------------------------------------------------------------------------------------------------------------------------------------------------------------------------------------------------------------|
| <i>set</i> <IDX> <NAME> <1><br><PASSWD> | It means to set group name and group password.<br><IDX>: Enter the index number (1 to 10) of the group.<br><NAME>: Enter the name of the group.<br><1>: It means the password flag.<br><PASSWD>: Enter a string as the password. |
| <i>show</i>                             | It means to display switch group status.                                                                                                                                                                                         |
| <i>add</i> <IDX> <MAC>                  | It means to add a switch into the group as a member switch.<br><IDX>: Enter the index number (1 to 10) of the group.<br><MAC>: Enter the MAC address of VigorSwitch.                                                             |
| <i>delete</i> <IDX> <MAC>               | It means to delete a switch from the group.<br><IDX>: Enter the index number (1 to 10) of the group.<br><MAC>: Enter the MAC address of VigorSwitch.                                                                             |

## Example

```
> swm group set 10 pease 1 jpsword
> swm group show
Index   Group Name  asswd Flag   Member Switch
-----
1       Default      0
2
3
4
5
6
7
8
9
10      pease        1

Name           IP Address      MAC
-----
---           192.168.1.13   1449bc43e579
---           192.168.1.11   1449bc4133f4 >
```

## Telnet Command: swm profile

This command is used to add, edit or display the switch management profile.

## Syntax

```
swm profile add/delete <MAC>
swm profile show
swm profile enable_all/disable_all <MAC>
```

## Syntax Description

| Parameter               | Description                                                                                                |
|-------------------------|------------------------------------------------------------------------------------------------------------|
| <i>add/delete</i> <MAC> | It means to add or delete a member switch from the profile.<br><MAC>: Enter the MAC address of the switch. |
| <i>show</i>             | It means to display switch profile.                                                                        |

|                                        |                                                                                                                                                    |
|----------------------------------------|----------------------------------------------------------------------------------------------------------------------------------------------------|
| <i>enable_all/disable_all</i><br><MAC> | It means to enable or disable all LAN ports of the specified switch managed by Vigor router.<br><MAC>: Enter the MAC address of the member switch. |
|----------------------------------------|----------------------------------------------------------------------------------------------------------------------------------------------------|

## Example

```

> swm profile show
Name          IP Address      MAC              Model  Group
-----
IP Address    MAC              Model
-----
192.168.1.13  1449bc43e579  G2100
192.168.1.11  1449bc4133f4  G2121
>

```

## Telnet Command: swm detail

This command is used to configure general settings (e.g., switch name, password) and port settings for VigorSwitch.

### Syntax

*swm detail comment* <MAC> <COMMENT>

*swm detail name* <MAC> <NAME>

*swm detail passwd* <MAC> <PASSWD>

*swm detail config* <MAC> <config>

*swm detail show*

*swm detail port show* <MAC>

*swm detail port* <MAC> <PORT> <FLAG> <SCHED1> <SCHED2> <DESCRIPTION>

*swm detail rate* <MAC> <PORT> <i/e> <e/d>

*swm detail rate* <MAC> <PORT> <i/e> <ratelimit>

### Syntax Description

| Parameter                         | Description                                                                                                                                                                                                                |
|-----------------------------------|----------------------------------------------------------------------------------------------------------------------------------------------------------------------------------------------------------------------------|
| <i>comment</i> <MAC><br><COMMENT> | It means to set a comment for VigorSwitch.<br><MAC>: Enter the MAC address of the VigorSwitch to be modified.<br><COMMENT>: Add an additional explanation for the switch.                                                  |
| <i>name</i> <MAC> <NAME>          | It means to set a name for VigorSwitch.<br><MAC>: Enter the MAC address of the VigorSwitch to be modified.<br><NAME>: Enter the name of VigorSwitch.                                                                       |
| <i>passwd</i> <MAC> <PASSWD>      | It means to set a login password for VigorSwitch.<br><MAC>: Enter the MAC address of the VigorSwitch to be modified.<br><NAME>: Enter the login password of VigorSwitch.                                                   |
| <i>config</i> <MAC> <config>      | It means to apply the configuration of VigorSwitch B to other Vigorswitch A.<br><MAC>: Enter the MAC address of the VigorSwitch A to be modified.<br><config>: Enter the index number of the profile set in VigorSwitch B. |
| <i>show</i>                       | It means to display comment, MAC and connection status of the switch.                                                                                                                                                      |
| <i>port show</i> <MAC>            | It means to display a list of LAN ports of the VigorSwitch.<br><MAC>: Enter the MAC address of the VigorSwitch to be modified.                                                                                             |

|                                                                       |                                                                                                                                                                                                                                                                                                                                                                                                                                                                                |
|-----------------------------------------------------------------------|--------------------------------------------------------------------------------------------------------------------------------------------------------------------------------------------------------------------------------------------------------------------------------------------------------------------------------------------------------------------------------------------------------------------------------------------------------------------------------|
| <i>port</i> <MAC> <PORT> <FLAG><br><SCHED1> <SCHED2><br><DESCRIPTION> | It means to set a description and schedule profile for each port of VigorSwitch.<br><MAC>: Enter the MAC address of the VigorSwitch to be modified.<br><PORT>: Enter the index number (e.g., 1 to 28) of the VigorSwitch LAN port. The number of LAN ports will vary according to the Switch to be modified.<br><SCHED1> <SCHED2>: Determine and type two index numbers of the schedule profiles you want.<br><DESCRIPTION>: Enter a description for each port of VigorSwitch. |
| <i>rate</i> <MAC> <PORT> <i/e><br><e/d>                               | It means to enable / disable the rate limit for each port of VigorSwitch.<br><MAC>: Enter the MAC address of the VigorSwitch to be modified.<br><PORT>: Enter the index number (e.g., 1 to 28) of the VigorSwitch LAN port. The number of LAN ports will vary according to the Switch to be modified.<br><i/e>: "i" means Ingress Rate; "e" means Egress Rate.<br><e/d> "e" means enable; "d" means disable the setting.                                                       |
| <i>rate</i> <MAC> <PORT> <i/e><br><ratelimit>                         | It means to modify the rate limit for each port of VigorSwitch.<br><MAC>: Enter the MAC address of the VigorSwitch to be modified.<br><PORT>: Enter the index number (e.g., 1 to 28) of the VigorSwitch LAN port. The number of LAN ports will vary according to the Switch to be modified.<br><i/e>: "i" means Ingress Rate; "e" means Egress Rate.<br><ratelimit>: Enter a value.                                                                                            |

## Example

```
> swm detail rate 1449bc43e579 6 i 3000
> swm detail rate 1449bc43e579 6 e 5000
> swm detail show
Idx  Name          MAC          Comment          Config          Status
-----
1    G2100          1449bc43e579          0 None          Connect
>
```

## Telnet Command: swm maintain

This command is used to reboot or reset the switch to factory default setting.

### Syntax

*swm maintain reboot* <MAC>

*swm maintain reset* <MAC>

*swm maintain show*

### Syntax Description

| Parameter           | Description                                                                                                                     |
|---------------------|---------------------------------------------------------------------------------------------------------------------------------|
| <i>reboot</i> <MAC> | It means to reboot VigorSwitch with current settings.<br><MAC>: Enter the MAC address of the VigorSwitch to be modified.        |
| <i>reset</i> <MAC>  | It means to reset VigorSwitch with factory default settings.<br><MAC>: Enter the MAC address of the VigorSwitch to be modified. |
| <i>show</i>         | It means to display comment, MAC and connection status of the switch.                                                           |

## Example

```
> swm maintain show
Name          IP Address          MAC          Model
```

```

-----
G2100          192.168.1.13      1449bc43e579 G2100
>

```

## Telnet Command: swm search

This command is used to search Vigor Switch by MAC / IP address / specific description and display information.

### Syntax

```

swm search mac <MAC>
swm search ip <IP>
swm search description <Input>

```

### Syntax Description

| Parameter                  | Description                                                      |
|----------------------------|------------------------------------------------------------------|
| <i>mac</i> <MAC>           | <MAC>: Enter the MAC address of the VigorSwitch to be searched.  |
| <i>ip</i> <IP>             | <IP>: Enter the IP address of the VigorSwitch to be searched.    |
| <i>description</i> <input> | <input>: Enter the model name of the VigorSwitch to be searched. |

### Example

```

> swm search mac 1449bc43e579
Type      IP Address      MAC              Description / Name      Lan Port
UpLink Port  Level  Port
-----
-----
Switch 192.168.1.13  14:49:BC:43:E5:79 G2100                P2
  Vigor Router    0      2
>

```

## Telnet Command: swm db

This command is used to enable/disable database to record switch management information.

### Syntax

```

swm db ctl en/dis
swm db ctl show
swm db alert notify <N/S>
swm db alert action <S/B>
swm db alert sms<IDX>
swm db alert mail <IDX>

```

### Syntax Description

| Parameter                 | Description                                                                                                                                 |
|---------------------------|---------------------------------------------------------------------------------------------------------------------------------------------|
| <i>ctl en/dis</i>         | It means to enable or disable the function of displaying database control status.<br>en: Enable the function.<br>dis: Disable the function. |
| <i>ctl show</i>           | It means to show the the database control status.                                                                                           |
| <i>alert notify</i> <N/S> | It means to set alert notification (N or S) condition when storage exceeded.<br>N:Don't send notification.                                  |

|                                 |                                                                                                                                                                                     |
|---------------------------------|-------------------------------------------------------------------------------------------------------------------------------------------------------------------------------------|
|                                 | S: Send notification.                                                                                                                                                               |
| <i>alert action &lt;S/B&gt;</i> | It means to set the alert action (S or B) condition when storage exceeded.<br>S: Stop recording urser information.<br>B: Backup and clean up all user info, and start a new record. |
| <i>alert sms &lt;IDX&gt;</i>    | It means to set SMS object which will get the information from Vigor router if something wrong with VigorSwitch.<br><IDX>: Enter the index number of the mail object.               |
| <i>alert mail &lt;IDX&gt;</i>   | It means to set mail object which will get the information from Vigor router if something wrong with VigorSwitch.<br><IDX>: Enter the index number of the mail object.              |

### Example

```
> swm db ctl en
Enable database to recoard SWM information.
```

## Telnet Command: swm alert

This command is used to define the name of alert, level of alert (in color), and determine to record the data in the database, or send a notification message to the user based on the level.

### Syntax

```
swm alert enable/disable
swm alert show
swm alert en/dis <ldx>
swm alert set <ldx> log <e/d>
swm alert set <ldx> name <name>
swm alert set <ldx> color <O/R/N>
swm alert set <ldx> notif <e/d>
swm alert set <ldx> obj <object idx> <object value>
swm alert display
swm alert en/dis <sw/port> <mac>
swm alert sw show <mac>
swm alert set sw <mac> <incident idx> <level idx>
swm alert port show <mac>
swm alert set port <mac> <port num><incident idx> <level idx>
```

### Syntax Description

| Parameter                              | Description                                                                                                                                                                           |
|----------------------------------------|---------------------------------------------------------------------------------------------------------------------------------------------------------------------------------------|
| <i>enable/disable</i>                  | It means to enable/disable Alert mechanism.<br>enable: Enable the mechanism.<br>disable: Disable the mechanism.                                                                       |
| <i>show</i>                            | It means to display a list of all alert setup.                                                                                                                                        |
| <i>en/dis &lt;ldx&gt;</i>              | It means to enable / disable the Alert Action settings.<br>en: Enable the settings.<br>dis: Disabel the settings.<br><ldx>: Enter the index number (1 to 8) of the alert action item. |
| <i>set &lt;ldx&gt; log &lt;e/d&gt;</i> | It means to enable / disable the function of creating log of alert.                                                                                                                   |



|                                                                                         |                                                                                                                                                                                                                                                                                                                                                                                                       |
|-----------------------------------------------------------------------------------------|-------------------------------------------------------------------------------------------------------------------------------------------------------------------------------------------------------------------------------------------------------------------------------------------------------------------------------------------------------------------------------------------------------|
|                                                                                         | <p>e: Enable the settings.<br/> d: Disabel the settings.<br/> &lt;Idx&gt;: Enter the index number (1 to 8) of the alert action item.<br/> Note that No Log for index 1; and log for index 2 is enabled in default.</p>                                                                                                                                                                                |
| <i>set &lt;Idx&gt; name &lt;name&gt;</i>                                                | <p>It means to set level name of each alert.<br/> &lt;Idx&gt;: Enter the index number (1 to 8) of the alert action item.<br/> &lt;name&gt;: Enter a short description of the alert.</p>                                                                                                                                                                                                               |
| <i>set &lt;Idx&gt; color &lt;O/R/N&gt;</i>                                              | <p>It means to define the color for each level of alert. The color of index 1 is No color and unable to be changed.<br/> &lt;Idx&gt;: Enter the index number (2 to 8) of the alert action item.<br/> &lt;O/R/N&gt;: "O" means orange; "R" means red; "N" means no color.</p>                                                                                                                          |
| <i>set &lt;Idx&gt; notif &lt;e/d&gt;</i>                                                | <p>It means to enable or disable the function of sending notification to specified phone number via SMS.<br/> &lt;Idx&gt;: Enter the index number (3 to 8) of the alert action item.<br/> e: Enable the settings.<br/> d: Disabel the settings.</p>                                                                                                                                                   |
| <i>set &lt;idx&gt; obj &lt;object idx&gt;<br/>&lt;object value&gt;</i>                  | <p>It means to specify SMS/Email service object(s) for the alert item. Each alert can be set with up to four objects.<br/> &lt;Idx&gt;: Enter the index number (3 to 8) of the alert action item.<br/> &lt;object idx&gt;: Enter the queue number (1 to 4) for specifying an object profile.<br/> &lt;object value&gt;: Enter the index number (1 to 10) of the SMS/Email service object profile.</p> |
| <i>display</i>                                                                          | <p>It means to display all switches with port alert state.</p>                                                                                                                                                                                                                                                                                                                                        |
| <i>en/dis &lt;sw/port&gt; &lt;mac&gt;</i>                                               | <p>It means to enable or disable the Switch Alert /Port Alert action.<br/> en: Enable the function.<br/> dis: Disable the function.<br/> &lt;sw/port&gt;: "sw" means Switch Alert; "port" means Port Alert.<br/> &lt;mac&gt;: Enter the MAC address of the VigorSwitch.</p>                                                                                                                           |
| <i>sw show &lt;mac&gt;</i>                                                              | <p>It means to display incident and alert type of the VigorSwitch.<br/> &lt;mac&gt;: Enter the MAC address of the VigorSwitch.</p>                                                                                                                                                                                                                                                                    |
| <i>set sw &lt;mac&gt; &lt;incident idx&gt;<br/>&lt;level idx&gt;</i>                    | <p>It means to set incident and alert type of the VigorSwitch.<br/> &lt;mac&gt;: Enter the MAC address of the VigorSwitch.<br/> &lt;incident idx&gt;: Range 1 - 4.<br/> &lt;level idx&gt;: 1 - 8.</p>                                                                                                                                                                                                 |
| <i>port show &lt;mac&gt;</i>                                                            | <p>Display Port Incident Alert.<br/> &lt;mac&gt;: Enter the MAC address of the VigorSwitch.</p>                                                                                                                                                                                                                                                                                                       |
| <i>set port &lt;mac&gt; &lt;port num&gt;<br/>&lt;incident idx&gt; &lt;level idx&gt;</i> | <p>Set Port Incident Alert.<br/> &lt;mac&gt;: Enter the MAC address (e.g., 001DAA0EB0DB) of the VigorSwitch.<br/> &lt;port num&gt;: Range 1 - 28.<br/> &lt;incident idx&gt;: Range 1 - 4.<br/> &lt;level idx&gt;: 1 - 8.</p>                                                                                                                                                                          |

## Example

```

> swm alert enable
> swm alert set 2 color N
> swm alert show
Idx En/Dis Level Color Create Log Send Notification(1-4)
-----
1 En No Alert No Color Disable Disable 0 , 0 , 0 , 0
2 En Minor Alert No Color Enable Disable 0 , 0 , 0 , 0
3 En Moderate Alert Orange Enable Disable 0 , 0 , 0 , 0
4 En Major Alert Red Enable Disable 0 , 0 , 0 , 0

```

|   |     |          |         |         |   |   |   |   |   |   |   |
|---|-----|----------|---------|---------|---|---|---|---|---|---|---|
| 5 | Dis | No Color | Disable | Disable | 0 | , | 0 | , | 0 | , | 0 |
| 6 | Dis | No Color | Disable | Disable | 0 | , | 0 | , | 0 | , | 0 |
| 7 | Dis | No Color | Disable | Disable | 0 | , | 0 | , | 0 | , | 0 |
| 8 | Dis | No Color | Disable | Disable | 0 | , | 0 | , | 0 | , | 0 |
| > |     |          |         |         |   |   |   |   |   |   |   |

## Telnet Command: swm log

This command is used to display switch managent log.

### Syntax

```
swm log show filter
swm log show day
swm log show week
swm log set level <idx> on/off
swm log set type <idx> on/off
swm log set switch <mac> on/off
```

### Syntax Description

| Parameter                            | Description                                                                                                                                                                      |
|--------------------------------------|----------------------------------------------------------------------------------------------------------------------------------------------------------------------------------|
| <i>show filter</i>                   | It means to display the log filter setup.                                                                                                                                        |
| <i>show day</i>                      | It means to display the quantity of day log.                                                                                                                                     |
| <i>show week</i>                     | It means to display the quantity of week log.                                                                                                                                    |
| <i>set level &lt;idx&gt; on/off</i>  | It means to turn on or turn off the alert level.<br><idx>: 1 to 8.<br>on/off: Set the status (on or off) of the alert.                                                           |
| <i>set type &lt;idx&gt; on/off</i>   | It means to turn on or turn off the port alert/switch alert.<br><idx>: 1 to 2. "1" means Port Alert; "2" means Switch Alert.<br>on/off: Set the status (on or off) of the alert. |
| <i>set switch &lt;mac&gt; on/off</i> | It means to set Switch Filter:<br><mac>: Enter the MAC address of the VigorSwitch.<br>on/off: Set the status (on or off) of the alert.                                           |

### Example

```
> swm log show filter
Index Status Level           En/Dis
-----
1   off   No Alert           En
2   off   Minor Alert        En
3   off   Moderate Alert     En
4   off   Major Alert        En
5   off                   Dis
6   off                   Dis
7   off                   Dis
8   off                   Dis

Index Status Type
-----
1   on    Port Alert
2   off   Switch Alert

Index Status Switch Name     Model  Mac Address
-----
1   off   G2100           G2100  1449bc43e579
> swm log set level 8 on
```

## Telnet Command: swm snmp

This command is used to display switch information via SNMP query.

### Syntax

```
swm snmp sys <MAC>
swm snmp iftbl <MAC> <port_num>
swm snmp poe <MAC>
swm snmp trpcom show <MAC>
swm snmp trpcom set <MAC> <name>
```

### Syntax Description

| Parameter                                  | Description                                                                                                                                                                                                                                                   |
|--------------------------------------------|---------------------------------------------------------------------------------------------------------------------------------------------------------------------------------------------------------------------------------------------------------------|
| <i>sys &lt;MAC&gt;</i>                     | It means to show the system information.<br><MAC>: Enter the MAC address of the VigorSwitch.                                                                                                                                                                  |
| <i>iftbl &lt;MAC&gt; &lt;port_num&gt;</i>  | It means to show port interface information.<br><MAC>: Enter the MAC address of the VigorSwitch.<br><port_num>: Enter the index number (e.g., 1 to 28) of the VigorSwitch LAN port. The number of LAN ports will vary according to the Switch to be modified. |
| <i>poe &lt;MAC&gt;</i>                     | It means to show snmp POE interface information.<br><MAC>: Enter the MAC address of the VigorSwitch.                                                                                                                                                          |
| <i>trpcom show &lt;MAC&gt;</i>             | It means to show Trap Community.<br><MAC>: Enter the MAC address of the VigorSwitch.                                                                                                                                                                          |
| <i>trpcom set &lt;MAC&gt; &lt;name&gt;</i> | It means to set Trap Community.<br><MAC>: Enter the MAC address of the VigorSwitch.<br><name>: Enter a string as tramp community.                                                                                                                             |

### Example

```
> swm snmp sys 1449BC43E579
sysDescr:
sysObjectID:1.3.6.1.4.1.7367
sysUpTime:988 hr 19 m 39 s
sysContact:Default
sysName:G2100
sysLocation:Default
sysServices:79
ifNumber:0
>
```

## Telnet Command: swm tr069

This command allows the user to configure TR-069 settings for Vigor router to communicate with VigorACS server.

### Syntax

```
swm tr069 show
swm tr069 user <xxx>
swm tr069 password <xxx>
```

```
swm tr069 <https/http>
swm tr069 port <xxx>
swm tr069 poll <xxx>
```

## Syntax Description

| Parameter                   | Description                                                                                              |
|-----------------------------|----------------------------------------------------------------------------------------------------------|
| <i>show</i>                 | Displays the switch management TR069 server settings.                                                    |
| <i>user &lt;xxx&gt;</i>     | Set a username for switch management TR069 server.<br><xxx> - Enter a string (max. 31 characters)        |
| <i>password &lt;xxx&gt;</i> | Set a password for switch management for TR069 server.<br><xxx> - Enter a password (max. 31 characters). |
| <i>&lt;https/http&gt;</i>   | Set the protocol for switch management for TR069 server.<br><https/http> - Choose https or http.         |
| <i>port &lt;xxx&gt;</i>     | Set the port number for switch management for TR069 server.<br><xxx>- Range from 1 to 65535.             |
| <i>poll &lt;xxx&gt;</i>     | Set the poll interval for switch management for TR069 server.<br><xxx>- Range from 1 to 999999.          |

## Example

```
> swm tr069 show

SWM TR069 via HTTP
SWM TR069 server port: 8003
SWM TR069 username: acs
SWM TR069 HTTP password: password
SWM TR069 poll_interval: 600

> swm tr069 poll 710
Set SWM TR069 poll interval to 710
```

## Telnet Command: fw\_backupmode

This command is used to backup the firmware to the router. The firmware will be retrieved for rebooting Vigor router after it crashes over three times.

## Syntax

```
fw_backupmode [<command><parameter>|...]
```

## Syntax Description

| Parameter                                     | Description                                                                                                              |
|-----------------------------------------------|--------------------------------------------------------------------------------------------------------------------------|
| <i>[&lt;command&gt;&lt;parameter&gt; ...]</i> | The available commands with parameters are listed below.<br>[...] means that you can Enter several commands in one line. |
| <i>-t n</i>                                   | Set the backup time.<br>n : 1 - 168 hours                                                                                |
| <i>-m n</i>                                   | Set the firmware backup mode.<br>1: Backup after timeout.<br>0: Backup after upgrade.                                    |
| <i>-b</i>                                     | Backup the firmware manually and immediately.                                                                            |
| <i>-r n</i>                                   | Set the firmware recovery mode.                                                                                          |

|  |                                                                             |
|--|-----------------------------------------------------------------------------|
|  | 1: the firmware will be recovered when the system crash.<br>0: No recovery. |
|--|-----------------------------------------------------------------------------|

## Example

```
> backupmode -b
Do Firmware backup now!!!.
```

## Telnet Command: service

This command is used to display information about MyVigor service. In addition, it allows to transfer MyVigor service from the original account to other account.

### Syntax

```
service -s
service -r
service -l <account><password>
service -i <new_owner><new_owner_email>
service -t <yes>/<no>
service -c
```

### Syntax Description

| Parameter                           | Description                                                                                                                                                                                          |
|-------------------------------------|------------------------------------------------------------------------------------------------------------------------------------------------------------------------------------------------------|
| -s                                  | Display the service status.                                                                                                                                                                          |
| -r                                  | Refresh the service status                                                                                                                                                                           |
| -l <account><password>              | Login to MyVigor server. Enter the account and password registered to MyVigor server<br>account - Enter the name of the account.<br>Password - Enter the password of the account.                    |
| -i <new_owner><br><new_owner_email> | Enter the name and the e-mail address of the new owner for service transfer.<br>New_owner - Enter the account name of the new owner.<br>New_owner_email - Enter the e-mail address of the new owner. |
| -t <yes>/<no>                       | Transfer this Vigor device to a new owner.                                                                                                                                                           |
| -c                                  | Clear current owner's account information.                                                                                                                                                           |

## Example

```
> service
> service -l carrieni ttt0016ttt5
Login Account:carrieni, Pw:ttt0016ttt5
Login Success! Please check Service Status again!
> service -s
Show service status.
Now state is [SS_STATE_REG_ACC_VALID]
Service Status:
Model Name   : Vigor2927 Series
Serial Number: 2019053108580701
MAC Address  : 00:1D:AA:73:4A:78
Owner Account: carrieni
E-mail       : ca*****i@draytek.com

Device service support status:
Service WCF, ID = [1]
  Service Provider [Cyren]
  Licese Start_date [2019-09-26]
  Licese Exp_date [2019-10-26]
```

```

Service APPE, ID=[4]
  Service Provider [Not Activated]
  Licese Start_date []
  Licese Exp_date []

Service DDNS, ID=[6]
  Service Provider [Not Activated]
  Licese Start_date []
  Licese Exp_date []

```

## Telnet Command: dmn

This command is used to set configuration related to mesh network, status display or trigger the mesh actions.

### Syntax

```

dmn enable <1/0>
dmn reset_group
dmn loglevel <1/0>
dmn search <start/show>
dmn status
dmn mynode
dmn discover <start/show>
dmn acs
dmn table <0/1/2/3>
dmn disconnect
dmn auto_reselect
dmn reselect

```

### Syntax Description

| Parameter                                 | Description                                                                                                                                                                                                                                                |
|-------------------------------------------|------------------------------------------------------------------------------------------------------------------------------------------------------------------------------------------------------------------------------------------------------------|
| <i>enable</i> <1/0>                       | Enable or disable the mesh function.<br>1 - Enable.<br>0 - Disable.                                                                                                                                                                                        |
| <i>reset_group</i>                        | Reset the group list and group key.                                                                                                                                                                                                                        |
| <i>loglevel</i> <1/0>                     | Set the mesh log level.<br>1 - detailed information.<br>0 - basic information.                                                                                                                                                                             |
| <i>search start</i><br><i>search show</i> | Search for available mesh nodes in the environment to join the Mesh Network.<br>start - Begin to search.<br>show - Display the searching result.                                                                                                           |
| <i>status</i>                             | Display the group status.                                                                                                                                                                                                                                  |
| <i>mynode</i>                             | Display the local status of this device. For example,<br>DrayTek> dmn mynode<br>% [dmn_cmd] my node:<br>Preferred Wireless Uplink : Auto<br>Operation Mode : MeshNode(Wired)<br>Root MAC : 00:00:00:00:00:00<br>Hop : 0<br>Uplink : none<br>Downlink (0) : |

|                                               |                                                                                                                                                                                                                                                                                                                                                                                                                                                                                    |
|-----------------------------------------------|------------------------------------------------------------------------------------------------------------------------------------------------------------------------------------------------------------------------------------------------------------------------------------------------------------------------------------------------------------------------------------------------------------------------------------------------------------------------------------|
|                                               | <p>Model : Vigor2927<br/> Device Name : DrayTek<br/> MAC : 00:1D:AA:70:33:E0<br/> State : Mesh Node (Wired Uplink) - Isolate<br/> Status : New</p>                                                                                                                                                                                                                                                                                                                                 |
| <i>discover start</i><br><i>discover show</i> | <p>Search for mesh devices (including mesh root and mesh node) around this router.<br/> start - Begin to search.<br/> show - Display the searching result.</p>                                                                                                                                                                                                                                                                                                                     |
| <i>acs</i>                                    | <p>Obtain information by sending requests to Mesh auto-configuration server.<br/> Available sub-commands include:<br/> (g)et - get mynode and station list<br/> (s)et - set all parameter<br/> prin(t) - print all list<br/> (c)lear - clear all method<br/> (p)ause - pause acs<br/> (r)esume - resume acs<br/> st(a)tus - acs group status<br/> sta(l)ist - print all node station list<br/> (u)p_sta_status - print update station list status<br/> r(e)set - reset dmn acs</p> |
| <i>table &lt;0/1/2&gt;</i>                    | <p>Display a device table of the mesh network.<br/> 0 - Originator table<br/> 1 - Local client table<br/> 2 - Remote client table</p>                                                                                                                                                                                                                                                                                                                                              |
| <i>disconnect &lt;mac&gt;</i>                 | <p>Disconnect an online wireless mesh node. In general, the mesh node will reconnect to Mesh Network later.<br/> &lt;mac&gt; - Enter the MAC address of the mesh node in a Mesh Group. (Ex. dmn disconnect 00:1d:aa:22:33:44)</p>                                                                                                                                                                                                                                                  |
| <i>auto_reselect</i>                          | <p>Enable (1) or disable (0) the auto reselection function. If enabled, the Mesh Root starts a Mesh Reselect automatically after the Mesh Network changed.</p>                                                                                                                                                                                                                                                                                                                     |
| <i>reselect</i>                               | <p>Start a Mesh Reselect immediately. An online Wireless Mesh Node may reconnect to a better Wireless uplink.</p>                                                                                                                                                                                                                                                                                                                                                                  |

## Example

```

> dmn refresh 2
% Delete [2] node and let it recover automatically
> dmn set rssi 50
> dmn

```