

# DrayTek

## Vigor3220

Multi-WAN Security Router



### Quick Start Guide

V1.1

# Vigor3220

## Multi-WAN Security Router

### Quick Start Guide

Version: 1.1

Firmware Version: V3.8.4.1\_RC4

(For future update, please visit [DrayTek web site](#))

Date: July 17, 2017

## Intellectual Property Rights (IPR) Information

### Copyrights

© All rights reserved. This publication contains information that is protected by copyright. No part may be reproduced, transmitted, transcribed, stored in a retrieval system, or translated into any language without written permission from the copyright holders.

### Trademarks

The following trademarks are used in this document:

- Microsoft is a registered trademark of Microsoft Corp.
- Windows, Windows 95, 98, Me, NT, 2000, XP, Vista, 7, 8 and Explorer are trademarks of Microsoft Corp.
- Apple and Mac OS are registered trademarks of Apple Inc.
- Other products may be trademarks or registered trademarks of their respective manufacturers.

## Safety Instructions and Approval

### Safety

#### Instructions

- Read the installation guide thoroughly before you set up the router.
- The router is a complicated electronic unit that may be repaired only by authorized and qualified personnel. Do not try to open or repair the router yourself.
- Do not place the router in a damp or humid place, e.g. a bathroom.
- Do not stack the routers.
- The router should be used in a sheltered area, within a temperature range of 0 to +45 Celsius.
- Do not expose the router to direct sunlight or other heat sources. The housing and electronic components may be damaged by direct sunlight or heat sources.
- Do not deploy the cable for LAN connection outdoor to prevent electronic shock hazards.
- Keep the package out of reach of children.
- When you want to dispose of the router, please follow local regulations on conservation of the environment.

### Warranty

We warrant to the original end user (purchaser) that the router will be free from any defects in workmanship or materials for a period of two (2) years from the date of purchase from the dealer. Please keep your purchase receipt in a safe place as it serves as proof of date of purchase. During the warranty period, and upon proof of purchase, should the product have indications of failure due to faulty workmanship and/or materials, we will, at our discretion, repair or replace the defective products or components, without charge for either parts or labor, to whatever extent we deem necessary to restore the product to proper operating condition. Any replacement will consist of a new or re-manufactured functionally equivalent product of equal value, and will be offered solely at our discretion. This warranty will not apply if the product is modified, misused, tampered with, damaged by an act of God, or subjected to abnormal working conditions. The warranty does not cover the bundled or licensed software of other vendors. Defects which do not significantly affect the usability of the product will not be covered by the warranty. We reserve the right to revise the manual and online documentation and to make changes from time to time in the contents hereof without obligation to notify any person of such revision or changes.



## EU Declaration of Conformity

We DrayTek Corp. , office at No.26, Fu Shing Road, HuKou County, Hsin-Chu Industry Park, Hsinchu 300, Taiwan , R.O.C., declare under our sole responsibility that the product

- **Product name:** Multi-WAN Security Firewall
- **Model number:** Vigor3220
- **Manufacturer:** DrayTek Corp.
- **Address:** No.26, Fu Shing Road, HuKou County, Hsin-Chu Industry Park, Hsinchu 300, Taiwan , R.O.C.

is in conformity with the relevant Union harmonisation legislation:

EMC Directive 2014/30/EU , Low Voltage Directive 2014/35/EU and RoHS 2011/65/EU with reference to the following standards

Standard	Version / Issue date
EN 55032	2012+AC:2013 class A
EN 61000-3-2	2014 Class A
EN 61000-3-3	2013
EN 55024	2010+A1:2015
EN 60950-1	2006 +A11:2009 +A1:2010 +A12:2011+ A2:2013

Hsinchu  
(place)

22nd June, 2017  
(date)

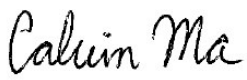
  
Calvin Ma / President  
(Legal Signature)

## Regulatory Information

### Federal Communication Commission Interference Statement

This equipment has been tested and found to comply with the limits for a Class A digital device, pursuant to Part 15 of the FCC Rules. These limits are designed to provide reasonable protection against harmful interference in a residential installation. This equipment generates, uses and can radiate radio frequency energy and, if not installed and used in accordance with the instructions, may cause harmful interference to radio communications. However, there is no guarantee that interference will not occur in a particular installation. If this equipment does cause harmful interference to radio or television reception, which can be determined by turning the equipment off and on, the user is encouraged to try to correct the interference by one of the following measures:

- Reorient or relocate the receiving antenna.
- Increase the separation between the equipment and receiver.
- Connect the equipment into an outlet on a circuit different from that to which the receiver is connected.
- Consult the dealer or an experienced radio/TV technician for help.

This device complies with Part 15 of the FCC Rules. Operation is subject to the following two conditions:

- (1) This device may not cause harmful interference, and
- (2) This device may accept any interference received, including interference that may cause undesired operation.

### Caution

Any changes or modifications not expressly approved by the grantee of this device could void the user's authority to operate the equipment.



More update, please visit [www.draytek.com](http://www.draytek.com).



## ***Table of Contents***

<b>1. Introduction.....</b>	<b>1</b>
<b>2. Package Content .....</b>	<b>2</b>
<b>3. Panel Explanation.....</b>	<b>3</b>
<b>4. Hardware Installation .....</b>	<b>5</b>
4.1 Network Connection .....	5
4.2 Wall-Mounted Installation .....	6
<b>5. Software Configuration .....</b>	<b>7</b>
5.1 Quick Start Wizard for Network Connection.....	7
<b>6. Customer Service .....</b>	<b>12</b>

# 1. Introduction

Vigor3220 is a broadband router. It integrates IP layer QoS, NAT session/bandwidth management to help users control works well with large bandwidth.

By adopting hardware-based VPN platform and hardware encryption of AES/DES/3DES, the router increases the performance of VPN greatly, and offers several protocols (such as IPSec/PPTP/L2TP) with up to 100 VPN tunnels (including 50 SSL VPN tunnels).

The object-based design used in SPI (Stateful Packet Inspection) firewall allows users to set firewall policy with ease. CSM (Content Security Management) provides users control and management in IM (Instant Messenger) and P2P (Peer to Peer) more efficiency than before. By the way, DoS/DDoS prevention and URL/Web content filter strengthen the security outside and control inside.

Object-based firewall is flexible and allows your network be safe. In addition, Vigor3220 supports USB interface for connecting USB printer to share printer or USB storage device for sharing files, or for 3G/4G WAN connection.

Vigor3220 provides two-level management to simplify the configuration of network connection. The user mode allows user accessing into WEB interface via simple configuration. However, if users want to have advanced configurations, they can access into WEB interface through admin mode.

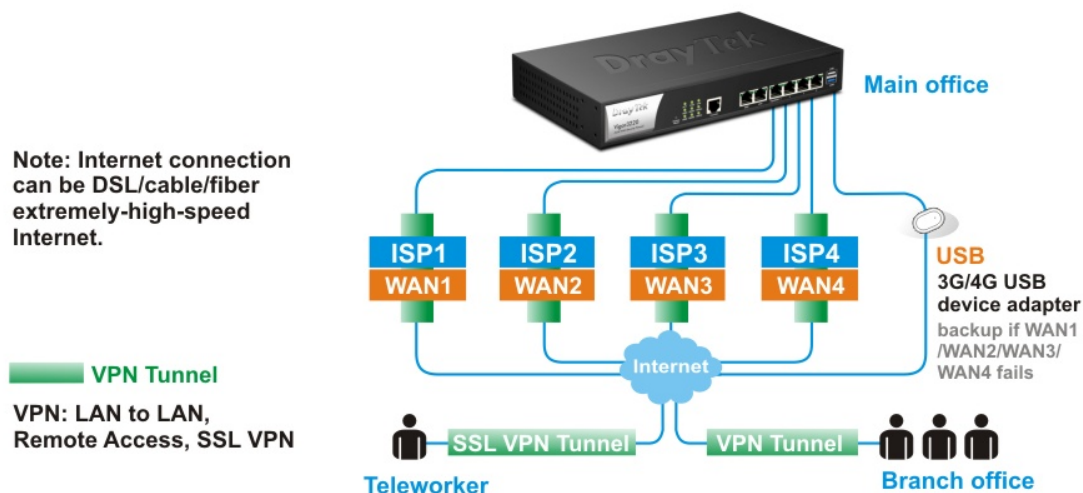



## 2. Package Content

Take a look at the package content. If there is anything missed or damaged, please contact DrayTek or dealer immediately.



**Vigor Router**

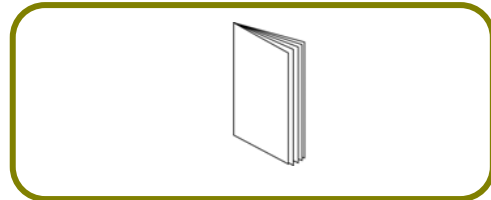

**Quick Start Guide**

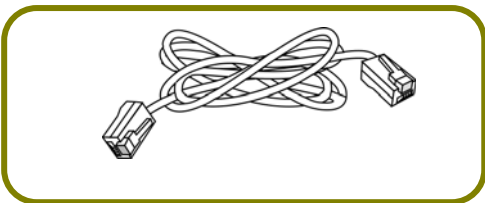

**RJ-45 Cat-5 Ethernet Cable**

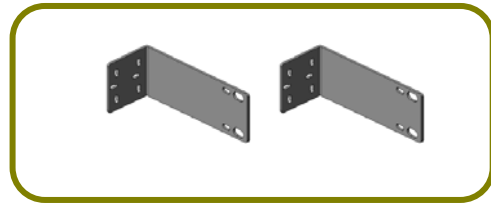

**Rack mount kit (brackets)**

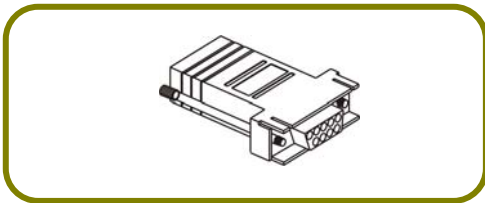

**Console Connector**

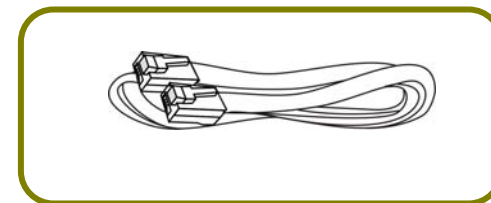

**Console Flat Cable**

The type of the power cord depends on the country that the router will be installed.

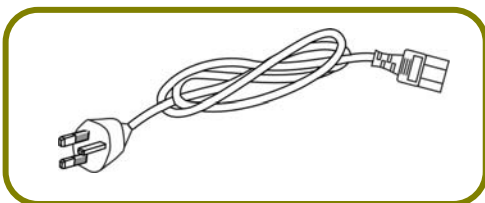

**UK-type Power Cord**



**EU-type Power Cord**



**USA/Taiwan-type Power Cord**



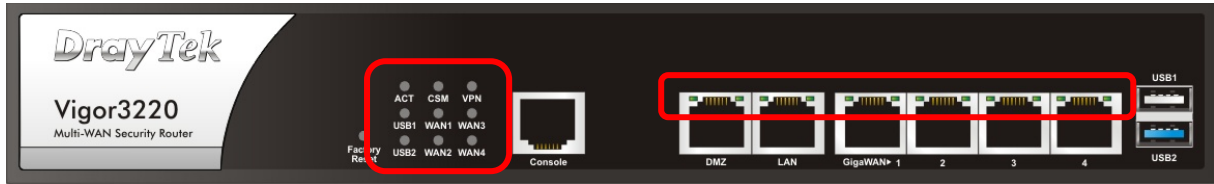

**AU/NZ-type Power Cord**

### 3. Panel Explanation

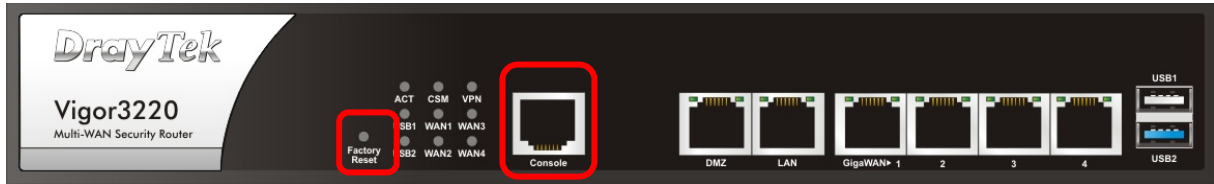

LED	Status	Explanation	
ACT (Activity)	Blinking	The router is powered on and running normally.	
	Off	The router is powered off.	
USB1~USB2	On	A USB device is connected and active.	
	Blinking	The data is transmitting.	
CSM	On	The profile of CSM (Content Security Management) for IM/P2P application is enabled from <b>Firewall &gt;&gt; General Setup</b> . (Such profile is established under CSM menu).	
WAN1-WAN4	On	The WAN connection is ready.	
	Blinking	It will blink while transmitting data.	
VPN	On	VPN tunnel is up and down.	
	Off	VPN services are disabled.	
	Blinking	Traffic is passing through VPN tunnel.	
<i>LED on Connector</i>			
DMZ	Left LED (Green)	On	The port is connected.
		Off	The port is disconnected.
		Blinking	The data is transmitting.
	Right LED (Green)	On	The port is connected with 1000Mbps.
		Off	The port is connected with 10/100Mbps.
		Blinking	The data is transmitting.
LAN	Left LED (Green)	On	The port is connected.
		Off	The port is disconnected.
		Blinking	The data is transmitting.
	Right LED (Green)	On	The port is connected with 1000Mbps.
		Off	The port is connected with 10/100Mbps.
		Blinking	The data is transmitting.
WAN1-WAN4	Left LED (Green)	On	The port is connected.
		Off	The port is disconnected.
		Blinking	The data is transmitting.
	Right LED (Green)	On	The port is connected with 1000Mbps.
		Off	The port is connected with 10/100Mbps.
		Blinking	The data is transmitting.



Interface	Description
Factory Reset	Restore the default settings. Usage: Turn on the router (ACT LED is blinking). Press the hole and keep for more than 5 seconds. When you see the ACT LED begins to blink rapidly than usual, release the button. Then the router will restart with the factory default configuration.
Console	Connector reserved for debug or obtaining log of Vigor system.
DMZ	Connector for local DMZ host.
LAN	Connectors for local networked devices.
WAN1~WAN4	Connector for remote networked devices.
USB1~USB2	Connector for a USB device (for 3G/4G USB Modem or printer).
	Connector for a power cord.
ON/OFF	Power Switch.

## 4. Hardware Installation

This section will guide you to install the router through hardware connection and configure the router's settings through web browser.

Before starting to configure the router, you have to connect your devices correctly.

### 4.1 Network Connection

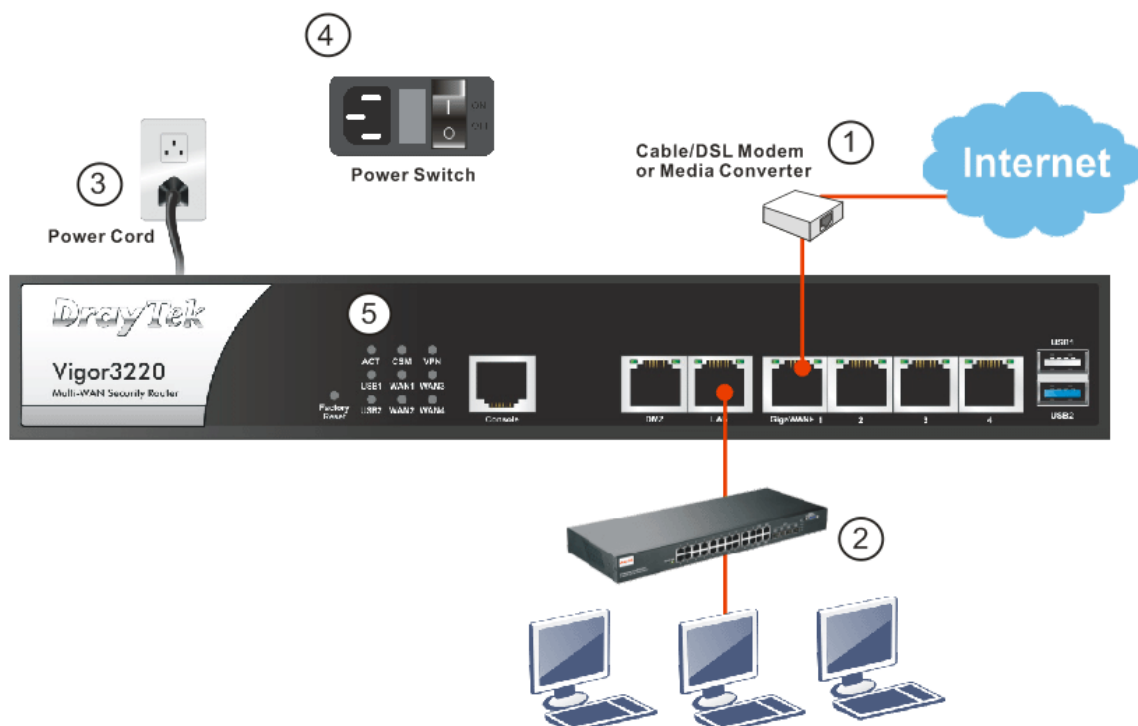

1. Connect the cable Modem/DSL Modem/Media Converter to any WAN port of router with Ethernet cable (RJ-45).
2. Connect one end of an Ethernet cable (RJ-45) to the **LAN** port of the router and the other end of the cable (RJ-45) into the Ethernet port on your computer. Or, use a switch to connect Vigor router and computer(s).
3. Connect one end of the power cord to the router's power port on the rear panel, and the other side into a wall outlet.
4. Power on the device by pressing down the power switch on the rear panel.



5. The system starts to initiate. After completing the system test, the **ACT** LED will light up and start blinking.

(For the detailed information of LED status, please refer to section 3. Panel Explanation)

## 4.2 Wall-Mounted Installation

Vigor can be mounted on the wall by using standard brackets shown below.

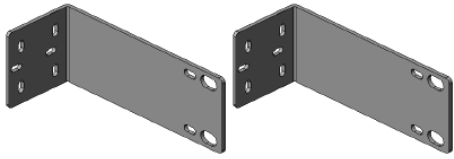

Choose a flat surface (on the wall) which is suitable for placing the router. Make the screw holes on the short side of the bracket aim at the screw holes on the router. Next, fasten both the bracket and the router with two screws; and fasten both the wall and the bracket with another two screws. Refer to the following figure.

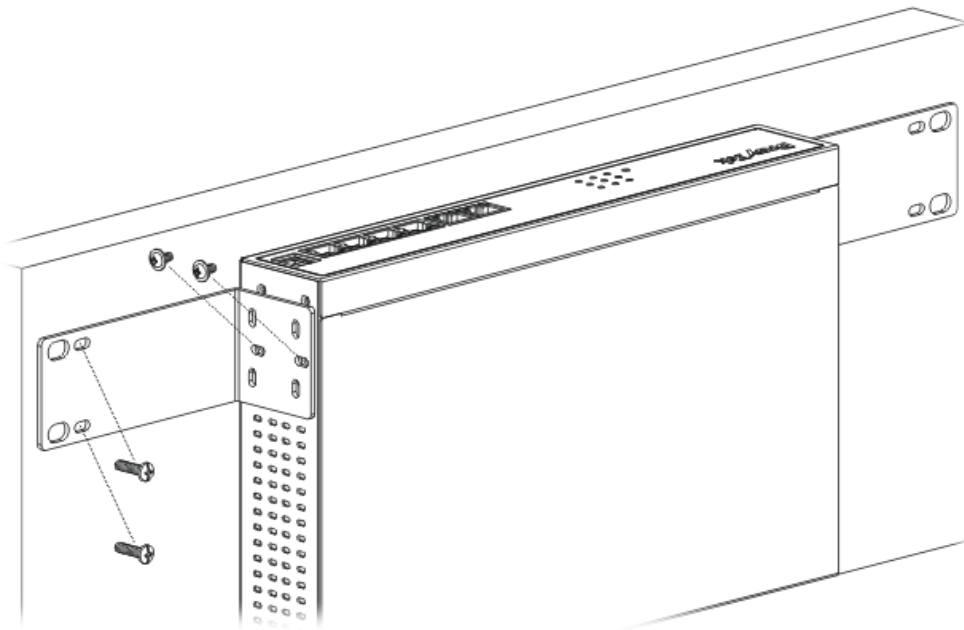

Then, continue to fasten the screws on the other side of the router and the wall with other screws.

When you finished about procedure, the router has been mounted on the wall firmly.

## 5. Software Configuration

To access Internet, please finish basic configuration after completing the hardware installation.

### 5.1 Quick Start Wizard for Network Connection

The **Quick Start Wizard** is designed for you to easily set up your router for Internet access. You can directly access the **Quick Start Wizard** via Web Configurator.

1. Make sure your PC connects to the router correctly.



---

**Note**

You may either simply set up your computer to get IP dynamically from the router or set up the IP address of the computer to be the same subnet as the default IP address of Vigor router 192.168.1.1. For the detailed information, please refer to the later section - Trouble Shooting on the user's guide.

---

2. Open a web browser on your PC and type **http://192.168.1.1**. A pop-up window will open to ask for username and password. Please type "admin/admin" as the Username/Password and click **Login**.

**DrayTek** **Vigor3220 Series**

**Login**

Username

Password

**Login**

Copyright © 2015 DrayTek Corp. All Rights Reserved.



---

**Note**

If you fail to access to the web configuration, please go to "Trouble Shooting" on User's Guide for detecting and solving your problem.

---

- Now, the Main Screen will pop up. Click Wizards>>Quick Start Wizard.

**DrayTek Vigor3220 Series**

Auto Logout | IR6

**Dashboard**

**System Information**

Model Name	Vigor3220n	System Up Time	0:1:38
Router Name	DrayTek	Current Time	2000 Jan 1 Sat 0:1:25
Firmware Version	3.8.4.1_RC4	Build Date/Time	May 22 2017 19:46:54
LAN MAC Address	00-1D-AA-F1-15-00		

**IPv4 Internet Access**

Line / Mode	IP Address	MAC Address	Up Time
WAN1 Ethernet / DHCP Client	Disconnected	00-1D-AA-F1-15-D1	00:00:00
WAN2 Ethernet / DHCP Client	Disconnected	00-1D-AA-F1-15-D2	00:00:00
WAN3 Ethernet / ---	Disconnected	00-1D-AA-F1-15-D3	00:00:00
WAN4 Ethernet / ---	Disconnected	00-1D-AA-F1-15-D4	00:00:00
WAN5 USB / ---	Disconnected	00-1D-AA-F1-15-D5	00:00:00

**Interface**

WAN	Connected : 0,	WAN1	WAN2	WAN3	WAN4	WAN5
LAN	Connected : 0,	Port1				
USB	Connected : 0,	USB 1	USB 2			

**Security**

VPN	Connected : 0	Remote Dial-In User / LAN to LAN
MyVigor	Activate : 0	

**System Resource**

CPU Usage:	1%
Memory Usage:	54%



**Note**

The home page will change slightly in accordance with the router you have.

- Enter the login password on the field of New Password and retype it on the field of Confirm Password. Then click Next to continue.

**Quick Start Wizard**

**Enter login password**

Please enter an alpha-numeric string as your **Password** (Max 23 characters).

Old Password

New Password

Confirm Password

- On the next page as shown below, please select the WAN interface (WAN 1 to WAN5) that you use. If Ethernet interface is used, please choose WAN1~WAN4. If USB interface is used, choose WAN5. For WAN 1 to WAN4,

choose **Auto negotiation** as the physical type for your router. Here we take WAN1 as an example. Then, click **Next** for next step.

**Quick Start Wizard**

---

**WAN Interface**

WAN Interface:	WAN1 ▾
Display Name:	<input type="text"/>
Physical Mode:	Ethernet
Physical Type:	Auto negotiation ▾ Auto negotiation 10M half duplex 10M full duplex 100M half duplex 100M full duplex 1000M full duplex

< Back   Next >   Finish   Cancel



**Note**

There are five WAN selections available for you to choose. In which WAN5 is selected for 3G USB modem connection.

---

6. On the next page as shown below, please select the appropriate protocol according to the information from your ISP. For example, you should select PPPoE mode if the ISP provides you PPPoE interface. Then click **Next** for next step.

**Quick Start Wizard**

---

**Connect to Internet**

**WAN 1**  
Select one of the following Internet Access types provided by your ISP.

- PPPoE
- PPTP
- L2TP
- Static IP
- DHCP

< Back   Next >   Finish   Cancel



PPPoE: If you click PPPoE as the protocol, after clicking Next, you will get the following web page. Please manually enter the Username/Password provided by your ISP. Then click Next.

Quick Start Wizard

---

PPPoE Client Mode

**WAN 1**  
Enter the user name and password provided by your ISP.

Service Name (Optional)	<input type="text"/>
Username	<input type="text"/>
Password	<input type="text"/>
Confirm Password	<input type="text"/>

PPTP/L2TP: if you click PPTP/L2TP, you will get the following page. Please type in all the information originally provided by your ISP. Then click Next for next step.

Quick Start Wizard

---

PPTP Client Mode

**WAN 1**  
Enter the username, password, WAN IP configuration and PPTP server IP provided by your ISP.

Username	<input type="text"/>
Password	<input type="text"/>
Confirm Password	<input type="text"/>
WAN IP Configuration	
<input type="radio"/> Obtain an IP address automatically	
<input checked="" type="radio"/> Specify an IP address	
IP Address	<input type="text"/>
Subnet Mask	<input type="text"/>
Gateway	<input type="text"/>
Primary DNS	<input type="text" value="8.8.8.8"/>
Second DNS	<input type="text" value="8.8.4.4"/>
PPTP Server	<input type="text"/>

**Static IP:** if you click Static IP, you will get the following page. Please type in the IP address information originally provided by your ISP. Then click Next for next step.

**Quick Start Wizard**

---

**Static IP Client Mode**

**WAN 1**  
Enter the Static IP configuration provided by your ISP.

WAN IP	<input type="text" value="172.16.3.302"/>
Subnet Mask	<input type="text" value="255.255.255.0"/>
Gateway	<input type="text" value="172.16.3.1"/>
Primary DNS	<input type="text" value="8.8.8.8"/>
Secondary DNS	<input type="text" value="8.8.4.4"/> (optional)

**DHCP:** if you click DHCP, you will get the following page. Simply click Next to continue.

**Quick Start Wizard**

---

**DHCP Client Mode**

**WAN 1**  
If your ISP requires you to enter a specific host name or specific MAC address, please enter it in.

Host Name	<input type="text" value="Vigor"/> (optional)
MAC	<input type="text" value="00"/> <input type="text" value="1D"/> <input type="text" value="AA"/> <input type="text" value="00"/> <input type="text" value="00"/> <input type="text" value="01"/> (optional)

7. Now you can see the following screen. It indicates that the setup is complete. Different types of connection modes will have different summary. Click **Finish** and then restart the router. Afterward, you will enjoy surfing on the Internet.

#### Quick Start Wizard

---

##### Please confirm your settings:

WAN Interface:	WAN1
Physical Mode:	Ethernet
Internet Access:	DHCP

Click **Back** to modify changes if necessary. Otherwise, click **Finish** to save the current settings and restart the Vigor router.

< Back

Next >

Finish

Cancel

## 6. Customer Service

If the router cannot work correctly after trying many efforts, please contact your dealer/DrayTek for further help right away. For any questions, please feel free to send e-mail to [support@draytek.com](mailto:support@draytek.com).

### Be a Registered Owner

Web registration is preferred. You can register your Vigor router via <http://www.draytek.com>.

### Firmware & Tools Updates

Due to the continuous evolution of DrayTek technology, all routers will be regularly upgraded. Please consult the DrayTek web site for more information on newest firmware, tools and documents.

<http://www.draytek.com>